

# Critical Areas Study-Revised East Lake Sammamish Master Plan Trail South Sammamish Segment B

Prepared for



**King County**

Parks and Recreation Division

July 2017

Prepared by

**Parametrix**

**EXHIBIT 16**  
**SSDP2016-00415**  
**000708**

---

# Critical Areas Study-Revised East Lake Sammamish Master Plan Trail - South Sammamish Segment B

*Prepared for*



## **King County**

Parks and Recreation Division  
201 South Jackson, Seventh Floor  
Seattle, WA 98104

*Prepared by*

## **Parametrix**

719 2nd Avenue, Suite 200  
Seattle, WA 98104  
T. 206.394.3700 F. 1.855.542.6353  
[www.parametrix.com](http://www.parametrix.com)



## CITATION

Parametrix. 2017. Critical Areas Study-Revised  
East Lake Sammamish Master Plan Trail - South Sammamish Segment B.  
Prepared by Parametrix, Seattle, WA. July 2017.

# TABLE OF CONTENTS

<b>1. INTRODUCTION .....</b>	<b>1-1</b>
1.1 PROJECT OVERVIEW.....	1-1
1.2 PURPOSE OF REPORT .....	1-2
1.3 PROJECT AREA.....	1-2
<b>2. METHODS.....</b>	<b>2-1</b>
2.1 REVIEW OF EXISTING LITERATURE .....	2-1
2.2 FIELD INVESTIGATION .....	2-1
2.3 WETLAND IDENTIFICATION .....	2-2
2.3.1 Vegetation .....	2-2
2.3.2 Soils.....	2-3
2.3.3 Hydrology .....	2-3
2.4 WETLAND CLASSIFICATION AND RATING .....	2-3
2.5 WETLAND FUNCTIONS .....	2-4
2.6 STREAM IDENTIFICATION AND CLASSIFICATION .....	2-4
2.7 LAKE SAMMAMISH.....	2-5
2.8 FISH AND WILDLIFE HABITAT CONSERVATION AREAS.....	2-5
2.9 CRITICAL AQUIFER RECHARGE AREAS.....	2-6
2.10 IMPACT ASSESSMENT .....	2-6
<b>3. RESULTS.....</b>	<b>3-1</b>
3.1 LANDSCAPE SETTING.....	3-1
3.2 WETLANDS .....	3-1
3.3 STREAMS .....	3-65
3.4 LAKE SAMMAMISH.....	3-75
3.5 FISH AND WILDLIFE HABITAT CONSERVATION AREAS.....	3-75
3.6 CRITICAL AQUIFER RECHARGE AREAS.....	3-76
<b>4. IMPACT ASSESSMENT .....</b>	<b>4-1</b>
4.1 WETLANDS .....	4-1
4.1.1 Permanent Wetland Impacts .....	4-2
4.1.2 Temporary Wetland Impacts.....	4-2
4.1.3 Permanent Wetland Buffer Impacts .....	4-2
4.1.4 Temporary Wetland Buffer Impacts.....	4-3
4.2 STREAMS .....	4-3
4.2.1 Stream Channel Impacts.....	4-4
4.2.2 Permanent Stream Buffer Impacts.....	4-8

**Exhibit 16**

**SSDP2016-00415**

**000711**

## TABLE OF CONTENTS (CONTINUED)

4.2.3	Temporary Stream Buffer Impacts .....	4-8
4.3	LAKE SAMMAMISH .....	4-8
4.3.1	Shoreline Setback Impacts .....	4-8
4.4	FISH AND WILDLIFE CONSERVATION AREAS .....	4-9
4.5	CRITICAL AQUIFER RECHARGE AREAS .....	4-10
<b>5.</b>	<b>MITIGATION APPROACH .....</b>	<b>5-1</b>
5.1	AVOIDANCE AND MINIMIZATION .....	5-1
5.2	RESTORATION OF TEMPORARY IMPACTS .....	5-2
5.3	COMPENSATORY MITIGATION .....	5-2
5.3.1	Summary of Proposed Mitigation .....	5-2
5.3.2	Wetlands, Wetland Buffers, Stream Buffers, and Shoreline Setback .....	5-3
5.3.3	Streams .....	5-6
5.3.4	Review of Best Available Science .....	5-6
5.3.5	Shoreline Zone Mitigation .....	5-7
5.3.6	Fish and Wildlife Habitat Conservation Areas Mitigation .....	5-7
5.4	MITIGATION GOALS, OBJECTIVES, AND PERFORMANCE STANDARDS .....	5-7
5.4.1	Mitigation Goals .....	5-8
5.4.2	Mitigation Objectives and Performance Standards .....	5-8
5.5	RECORD DRAWINGS .....	5-11
5.6	MONITORING .....	5-11
5.6.1	Quantitative Monitoring .....	5-11
5.6.2	Qualitative Monitoring .....	5-12
5.7	MAINTENANCE .....	5-12
5.8	CONTINGENCY MEASURES .....	5-12
5.9	PERFORMANCE SECURITY/FINANCIAL ASSURANCE .....	5-13
5.10	SITE PROTECTION .....	5-13
5.11	LONG-TERM MANAGEMENT PLAN .....	5-13
<b>6.</b>	<b>REFERENCES .....</b>	<b>6-1</b>

### APPENDICES

- A Wetland Determination Data Forms
- B Wetland Rating Forms
- C Wetland Functions and Values Forms
- D Critical Area Impact Figures
- E Critical Areas Mitigation Landscape Plans

# TABLE OF CONTENTS (CONTINUED)

## LIST OF FIGURES

1-1	Site Location Map .....	1-3
3-1	Drainage Basins, Subbasins, and Site Characteristics .....	3-3
3-2a	Critical Areas Map .....	3-5
3-2b	Critical Areas Map .....	3-7
3-2c	Critical Areas Map .....	3-9
3-2d	Critical Areas Map .....	3-11
3-2e	Critical Areas Map .....	3-13
3-2f	Critical Areas Map .....	3-15
3-2g	Critical Areas Map .....	3-17

## LIST OF TABLES

2-1	Key to Plant Indicator Status Categories.....	2-3
2-2	City of Sammamish Standard Wetland Buffer Widths.....	2-4
2-3	Wetland Functions and Values Assessed .....	2-4
2-4	City of Sammamish Standard Stream Buffer Widths .....	2-5
3-1	Summary of Wetlands in the Project Vicinity .....	3-2
3-2	Summary of Wetland Functions and Values for Wetlands in the Project Area Identified by Parametrix.....	3-19
3-3	Summary of Streams Crossing the Project Area .....	3-66
4-1	Summary of Impacts on Wetlands and Buffers .....	4-1
4-2	Summary of Impacts on Stream Channels and Buffers .....	4-5
5-1	Proposed Mitigation Locations and Type .....	5-3
5-2	City of Sammamish Wetland Mitigation Ratios <sup>a</sup> .....	5-4
5-3	Ecology-Recommended Wetland Mitigation Ratios for Projects in Western Washington .....	5-4
5-4	Wetland Mitigation Area Required Applying the Ecology-Recommended Mitigation Ratios for Projects in Western Washington for Reestablishment or Creation and Enhancement.....	5-4
5-5	Contingency Measures for the Mitigation Sites .....	5-13

## ACRONYMS AND ABBREVIATIONS

BMP	best management practice
AASHTO	American Association of State Highway and Transportation Officials
BNSF	Burlington Northern Santa Fe
CARAs	critical aquifer recharge areas
CAS	Critical Areas Study
cfs	cubic feet per second
dbh	diameter at breast height
Ecology	Washington State Department of Ecology
ESA	Endangered Species Act
FEMA	Federal Emergency Management Agency
FIRM	Flood Insurance Rate Maps
FWHCAs	Fish and Wildlife Habitat Conservation Areas
GIS	geographic information system
LWD	large woody debris
Master Plan Trail	East Lake Sammamish Master Plan Trail
NMFS	National Marine Fisheries Service
NRCS	Natural Resources Conservation Service
NWI	National Wetlands Inventory
OHWM	ordinary high water mark
RCW	Revised Code of Washington
RM	river mile
SMC	Sammamish Municipal Code
SMP	Shoreline Master Program
TDA	threshold discharge areas
USACE	U.S. Army Corps of Engineers
USFWS	U.S. Fish and Wildlife Service
WAC	Washington Administrative Code
WDFW	Washington Department of Fish and Wildlife
WDNR	Washington State Department of Natural Resources
WRIA	Water Resource Inventory Area
WSDOT	Washington State Department of Transportation

# 1. INTRODUCTION

## 1.1 Project Overview

King County is proposing to develop the East Lake Sammamish Master Plan Trail (Master Plan Trail)—an approximately 11-mile regional multi-user trail and nonmotorized alternative transportation corridor located near the eastern shore of Lake Sammamish. The entire project site is located along the existing Interim Use Trail in the King County right-of-way that extends from Gilman Boulevard in Issaquah to Bear Creek in Redmond. The Interim Use Trail is located on the alignment of the former Burlington Northern Santa Fe (BNSF) railroad that began operations in 1855 and ceased operations along this corridor in 1996. King County acquired the rail-banked corridor in 1998 and completed construction of the Interim Use Trail in 2006.

Proposed improvements of the Master Plan Trail will be constructed in multiple segments—Redmond, Issaquah, North Sammamish, and South Sammamish (Segments A and B). The Redmond Segment of the trail was constructed in 2011, the Issaquah Segment in 2012/2013, the North Sammamish Segment in 2014/2015, and the South Sammamish Segment A is currently in the permitting process. The South Sammamish Segment B of the proposed trail is the focus of this report, scheduled for construction in 2018. This trail segment is approximately 3.5 miles, extending from SE 33rd Street to Kokomo Drive (vicinity of Inglewood Hill Road) (Figure 1-1).

An existing gravel trail (i.e., the Interim Use Trail) is located in the project corridor. The Master Plan Trail will be the “full” buildout of the trail and will replace the existing soft-surface Interim Use Trail along a similar alignment. The Interim Use Trail is typically 8 to 12 feet wide and will be widened to accommodate the Master Plan Trail, which is typically 12 feet of pavement bounded by two 2-foot-wide shoulders and 1-foot-wide clear zones, in accordance with American Association of State Highway and Transportation Officials (AASHTO) guidelines. The project will include:

- Construction of a 12-foot-wide paved regional trail with soft-surface (gravel) shoulders;
- Related earthwork;
- Drainage improvements related to the trail;
- Culvert replacements to improve fish passage;
- Retaining walls and other site improvements;
- Landscaping and fencing; and
- Access and traffic control (bollards, striping, signage, etc.).

The Master Plan Trail will provide a paved multi-use trail for bicyclists, pedestrians, and others between cities within the Urban Growth Area—Issaquah, Sammamish, and Redmond. The trail will provide an off-road facility and route as a nonmotorized alternative to surrounding congested arterials. As a result, the project will promote nonmotorized access to employment, retail, and recreation centers within the city of Sammamish as well as provide a regional link with Redmond, Issaquah, and other cities and regional growth centers as an important component of the Regional Trails System.

The South Sammamish Segment B of the Master Plan Trail is part of the expanding Regional Trails System that provides a network of off-road, multi-use, nonmotorized transportation facilities used by thousands of bicyclists, pedestrians, and others daily for commuting to work or school, local travel, and recreation. The existing Regional Trails System now comprises approximately 300 miles of alternative transportation

Exhibit 16

SSDP2016-00415

000715 1-1



corridors. The Master Plan Trail is among the most significant of these due to its strategic location within King County, its length, and its connections via urban centers, city centers, and many land uses (residential, commercial, retail, professional, institutional, government, historic districts, and recreation areas). The Master Plan Trail extends the Burke-Gilman and Sammamish River Trails to create a 42-mile regional alternative transportation corridor stretching from Seattle to Issaquah and beyond to the Cascades. This project is an important part of that extension. The South Sammamish Segment B will provide many direct local benefits, including a connection to the new Sammamish Landing Park. The Master Plan Trail also will link with other regional trails.

## 1.2 Purpose of Report

According to the City of Sammamish Environmentally Critical Areas Regulations, an applicant for a development proposal shall submit a Critical Areas Study (CAS) where impacts to or alteration of an environmentally critical area is proposed or may occur as a consequence of proposed actions (Sammamish Municipal Code [SMC] 21A.50.120). King County is proposing an alignment that follows the existing Interim Use Trail, which is also the location of a former railbed. The proposed project is consistent with City trail corridor development standards (SMC 21A.30.210(1)—Use of Existing Corridors) that state trails should generally be located along existing cleared areas or on improved corridors. This is also consistent with the City’s regulations regarding permitted alterations to wetlands and streams (SMC 21A.50.300(10); SMC 21A.50.340(7)). These regulations state that the use of existing crossings, including but not limited to utility corridors, road and railroad rights-of-way within wetlands, streams, or buffers for public or private trails, is preferred to new crossings, subject to the standards and requirements in the SMC.

The CAS was prepared to satisfy these City of Sammamish requirements by describing wetlands, streams, Fish and Wildlife Habitat Conservation Areas (FWHCAs), and critical aquifer recharge areas (CARAs) within the project area; evaluating potential impacts on these critical areas from the proposed trail; and presenting mitigation for these impacts. Other critical areas regulated by the City of Sammamish, such as landslide hazard areas or erosion and seismic hazard areas, are not addressed in this CAS. Information presented herein is intended to facilitate environmental review and permitting.

The CAS was prepared in October 2016 and submitted to the City in December 2016. This revised CAS responds to comments from the City, including comments prepared by the City’s consultant, The Watershed Company (TWC), entitled Environmental Peer Review Report, East Lake Sammamish Trail Segment B.

## 1.3 Project Area

The project area is a linear corridor in the King County right-of-way along the eastern shore of Lake Sammamish within the city of Sammamish that closely parallels East Lake Sammamish Parkway NE (to the east) for much of the corridor, between the city’s south boundary near SE 33rd Street to Kokomo Drive (vicinity of Inglewood Hill Road). The right-of-way varies from 50 to 200 feet in width along the trail. The South Sammamish Segment B is located in Sections 6, 7, and 8 in Township 24 North, Range 6 East, Willamette Meridian and Sections 29, 31, and 32 in Township 25 North, Range 6 East, Willamette Meridian. The project corridor is a former railroad right-of-way, surrounded by single-family residential land use. The project area includes 37 wetlands and 18 streams.

Path: P:\654\_1521\_075\_SammamishTrail\SSammamish\_TDA\_Segment\_B\_SiteLocation.mxd

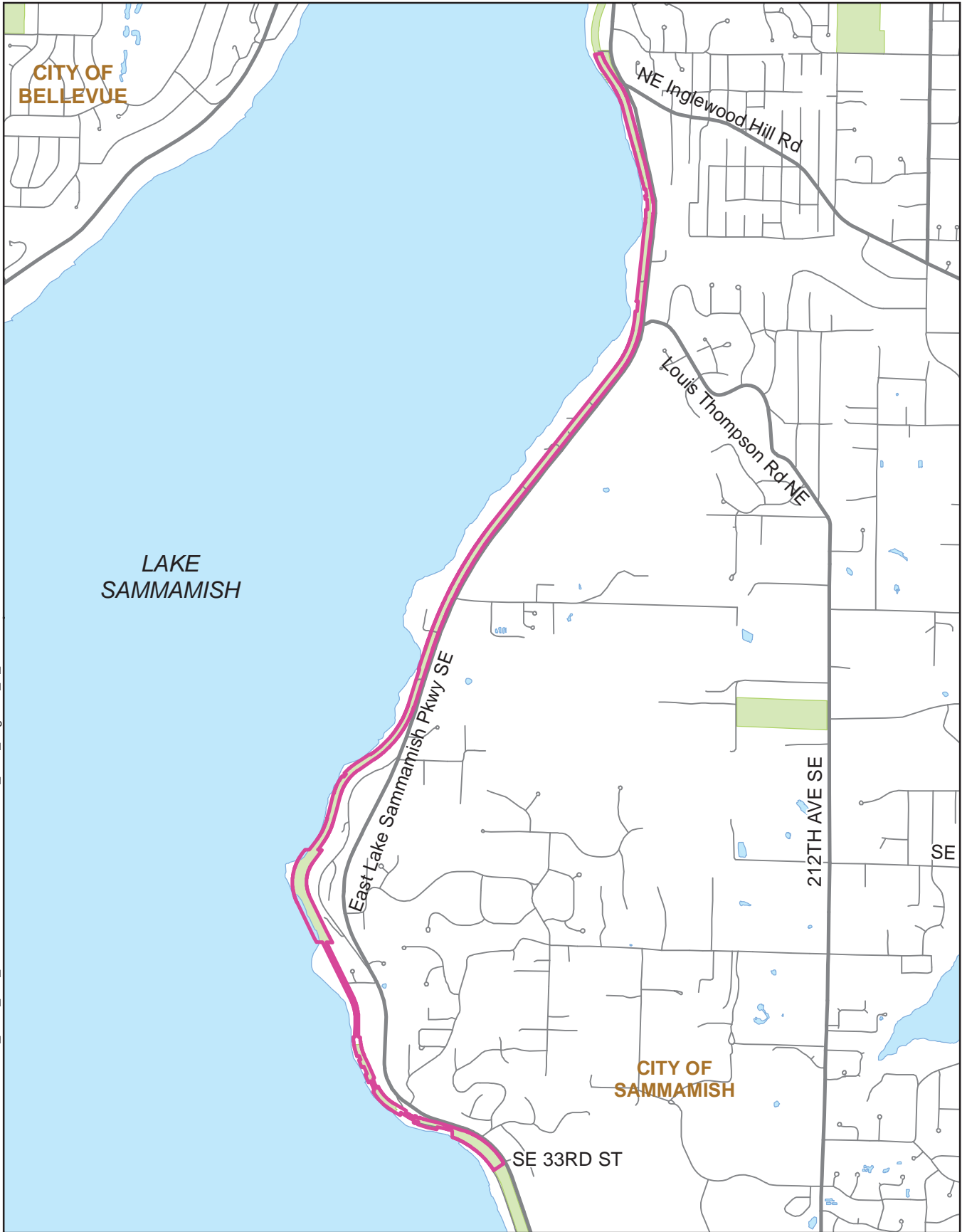

Parametrix

 Project Location

**Figure 1-1**  
**Site Location Map**  
**East Lake Sammamish Trail**  
**South Sammamish - Segment B**

Exhibit 16  
SSDP2016-00415  
000717

## 2. METHODS

This report is based on a review of existing information and field investigations. The goal of these efforts is to collect and document existing information that reflects current site conditions for assessing potential impacts.

### 2.1 Review of Existing Literature

Prior to conducting fieldwork, and throughout the duration of project design, biologists reviewed existing information to identify wetlands, streams, vegetation patterns, topography, soils, wildlife habitats, and other natural resources in the project area. Existing data sources that were reviewed for this report included but were not limited to the following:

- City of Sammamish critical area maps
- Soil Survey of King County Area, Washington. U.S. Department of Agriculture, Natural Resources Conservation Service (NRCS) (Snyder et al. 1973)
- National Wetlands Inventory (NWI), online wetlands mapper (U.S. Fish and Wildlife Service [USFWS] 2013)
- A Catalog of Washington Streams and Salmon Utilization, Volume 1, Puget Sound Region (Williams et al. 1975)
- SalmonScope online mapping tool (Washington Department of Fish and Wildlife [WDFW] 2016a)
- Final East Lake Sammamish Basin and Nonpoint Action Plan (King County 1994)
- Salmon and Steelhead Habitat Limiting Factors Report for the Cedar-Sammamish Basin (Kerwin 2001)
- East Lake Sammamish Master Plan Trail Fish and Fish Habitat Technical Report (Parametrix 2006)
- East Lake Sammamish Master Plan Trail Wetland Biology Discipline Report (Parametrix 2005)
- Online Priority and Habitat Species listed by the Washington Department of Fish and Wildlife (WDFW 2016b)
- List of Sections That Contain Natural Heritage Features (Washington State Department of Natural Resources [WDNR] 2016)
- Draft Biological Assessment for the East Lake Sammamish Trail Master Plan (Parametrix 2007)
- Federal Emergency Management Agency (FEMA) Flood Insurance Rate Maps (FIRM) and Flood Insurance Studies

### 2.2 Field Investigation

Wetland and stream field investigations were initially conducted in 1999 and 2000 to identify and delineate wetlands and streams as part of the East Lake Sammamish Master Plan Trail Final Environmental Impact Statement (King County 2010). Project biologists re-delineated wetlands and streams in November and December 2007; January, March, and April 2008; and January 2009 to identify and document current resource conditions in the project corridor (since more than 5 years had lapsed). The King County Department of Permitting and Environmental Review (formerly Department of Development and Environmental Services) biologist reviewed the wetlands in Sammamish in the winter

of 2008/2009. Wetlands and streams within the South Sammamish Segments were re-evaluated and/or verified by project biologists in 2013 and 2014 to update any areas where changes may have occurred due to recent development or natural conditions in the project vicinity since 2008. New wetland boundaries were delineated and flagged only where there was a change in conditions. If conditions remained the same, no changes to the boundary were made. Recent field observations are documented in this report.

## 2.3 Wetland Identification

Biologists delineated wetlands in 2007/2008/2009 according to the methods specified in the U.S. Army Corps of Engineers (USACE) Wetlands Delineation Manual (Environmental Laboratory 1987). At that time, these methods complied with those in the Washington State Wetland Identification and Delineation Manual (Washington State Department of Ecology [Ecology] 1997).

Biologists re-evaluated wetlands in 2013/2014 according to the methods specified in the USACE's Wetlands Delineation Manual (Environmental Laboratory 1987) and the Regional Supplement to the Corps of Engineers Wetland Delineation Manual: Western Mountains, Valleys, and Coast Region (Version 2.0) (USACE 2010). These methods comply with those adopted by Washington State pursuant to Washington Administrative Code (WAC) 173-22-035, Revised Code of Washington (RCW) 90.58.380, and the City of Sammamish under SMC 21A.15.1415.

Wetlands are defined as those areas that are inundated or saturated by surface or groundwater at a frequency and duration sufficient to support, and that under normal circumstances do support, a prevalence of vegetation typically adapted for life in saturated soil conditions. Wetlands generally include, but are not limited to, swamps, marshes, bogs, and similar areas. An area must have at least one positive field indicator for each of wetland vegetation, soils, and hydrology to be considered a wetland. The delineated wetlands were instrument-surveyed by professional land surveyors. Wetland determination data forms were recorded for each wetland (Appendix A).

### 2.3.1 Vegetation

The dominant plants and their wetland indicator status were evaluated to determine whether the vegetation is hydrophytic. Hydrophytic vegetation is generally defined as vegetation adapted to prolonged saturated soil conditions. To meet the hydrophytic vegetation criterion, more than 50 percent of the dominant plants must be facultative, facultative wetland, or obligate, according to the plant indicator status category assigned to each plant species by the USACE National Wetland Plant List (Lichvar et al. 2014). Table 2-1 provides the definitions of the indicator status categories. The scientific and common names for plants follow the currently accepted nomenclature. Dominant plant species were observed and recorded on wetland determination data forms for each data plot (Appendix A).

**Table 2-1. Key to Plant Indicator Status Categories**

Plant Indicator Status Category	Symbol	Definition
Obligate Wetland Plants	OBL	Plants that almost always (>99% of the time) occur in wetlands but may rarely (<1% of the time) occur in non-wetlands
Facultative Wetland Plants	FACW	Plants that often (67% to 99% of the time) occur in wetlands but sometimes (1% to 33% of the time) occur in non-wetlands
Facultative Plants	FAC	Plants with a similar likelihood (33% to 66% of the time) of occurring in both wetlands and non-wetlands
Facultative Upland Plants	FACU	Plants that sometimes (1% to 33% of the time) occur in wetlands but occur more often (67% to 99% of the time) in non-wetlands
Upland Plants	UPL	Plants that rarely (<1% of the time) occur in wetlands and almost always (> 99% of the time) occur in non-wetlands

Source: Environmental Laboratory (1987).

### 2.3.2 Soils

Generally, an area must have hydric soils to be considered a wetland. Hydric soil forms when soils are saturated, flooded, or ponded long enough during the growing season to develop anaerobic conditions in the upper portion. Biological activities in saturated soil result in reduced concentrations of oxygen that in turn result in a preponderance of organisms that use anaerobic processes for metabolism. Over time, anaerobic biological processes result in certain soil color patterns, which are used as indicators of hydric soil. Typically, low-chroma colors are formed in the matrix of hydric soil. Bright-colored redoximorphic features form within the matrix under a fluctuating water table. Other important hydric soil indicators include organic matter accumulations in the surface layer, reduced sulfur odors, and organic matter staining in the subsurface. Soils were examined by excavating sample pits to a depth of 18 inches or more to observe the soil profiles, colors, and textures. Munsell color charts (GretagMacbeth 2000) were used to describe the soil colors.

### 2.3.3 Hydrology

The project area was examined for evidence of hydrology. An area is considered to have wetland hydrology when soils are ponded or saturated consecutively 12.5 percent of the growing season. Primary indicators of hydrology include surface inundation and saturated soils, among others. Secondary indicators of hydrology include drainage patterns and water-stained leaves.

## 2.4 Wetland Classification and Rating

Delineated wetlands were classified according to the USFWS Classification of Wetlands and Deepwater Habitats of the United States (Cowardin et al. 1979). Hydrogeomorphic classifications were assigned to wetlands using USACE methods established in A Hydrogeomorphic Classification for Wetlands (Brinson 1993). In accordance with SMC 21A.50.290, wetlands were rated using the revised Washington State Wetland Rating System for Western Washington (Hruby 2004) (Appendix B).

The standard buffer widths for the wetlands in the project area are those required under SMC 21A.50.290(2) (Table 2-2).

**Table 2-2. City of Sammamish Standard Wetland Buffer Widths**

Wetland Category		Standard Buffer Width (feet)
Category I	Natural Heritage or bog wetlands	215
	Habitat score 29 – 36	200
	Habitat score 20 – 28	150
	Not meeting above criteria	125
Category II	Habitat score 29 – 36	150
	Habitat score 20 – 28	100
	Not meeting above criteria	75
Category III	Habitat score 20 – 28	75
	Not meeting above criteria	50
Category IV	All land use types – 50	
Category III and IV	Subject to SMC <a href="#">21A.50.320</a>	

Source: SMC 21A.50.290(2)

## 2.5 Wetland Functions

Functions of individual project area wetlands delineated by Parametrix were assessed using the Washington State Department of Transportation (WSDOT) Wetland Functions Characterization Tool for Linear Projects (Null et al. 2000). This is a qualitative tool designed for linear projects to enable the rapid documentation and characterization of functions and values of a particular wetland. This method allows evaluation of wetland functions using best professional judgment and readily observed environmental characteristics. For example, an area of permanent open water is characteristic of a wetland that provides habitat for waterfowl or aquatic animals. The upland habitats and buffers surrounding wetlands were also considered in the evaluation because adjacent land uses affect the performance of wetland functions. Biologists reviewed the indicator characteristics present for each affected wetland and assigned a summary rating of low, low-moderate, moderate, moderate-high, or high for each wetland function (Appendix C). Table 2-3 lists the wetland functions and values evaluated.

**Table 2-3. Wetland Functions and Values Assessed**

Flood Flow Alteration	Habitat for Amphibians
Sediment Removal	Habitat for Wetland-Associated Mammals
Nutrient and Toxicant Removal	Habitat for Wetland-Associated Birds
Erosion Control and Shoreline Stabilization	General Fish Habitat
Production of Organic Matter and its Export	Native Plant Richness
General Habitat Suitability	Educational or Scientific Value
Habitat for Aquatic Invertebrates	Uniqueness and Heritage

## 2.6 Stream Identification and Classification

Streams are defined as those areas in the city where surface waters produce a defined channel or bed, not including irrigation ditches, canals, storm or stormwater runoff conveyance devices, or other entirely artificial watercourses, unless they are used by salmonids or are used to convey streams naturally occurring prior to construction of such watercourses (SMC 21A.15.1240). For the purpose of this study, a defined channel or bed is an area that demonstrates clear evidence of the passage of water and includes, but is not limited to, bedrock channels, gravel beds, sand and silt beds, and defined

channel swales. The channel or bed need not contain water year-round. The ordinary high water mark (OHWM) of project area streams was identified and instrument-surveyed by professional land surveyors. Stream data were based on the 2006 East Lake Sammamish Master Plan Trail Fish and Fish Habitat Technical Report (Parametrix 2006) and observations made during subsequent field investigations. These data have also assisted in determining where fish passage improvements are recommended.

Streams were classified according to City of Sammamish regulations (SMC 21A.15.1240) and the Washington State water typing system. Stream type determinations were also informed by determinations of presumed fish use according to WAC 222-16-031 and SMC 21A.15.1240. The types were applied to the stream reaches located within the project area. Buffer widths assigned to streams reflect standard buffer requirements in SMC 21A.50.330(1) (Table 2-4).

**Table 2-4. City of Sammamish Standard Stream Buffer Widths**

Stream Type	Standard Buffer Width (feet)
Type S	150
Type F	150
Type Np	75
Type Ns	50

Source: SMC 21A.50.330

## 2.7 Lake Sammamish

Portions of the project area are within 200 feet of Lake Sammamish, placing it within the shoreline jurisdiction. The City of Sammamish Shoreline Master Program (SMP) provides the goals, policies, and regulations for use and development within the shoreline area. According to SMC 25.06.020(9), a 50-foot shoreline setback (extending from the OHWM) is established for Lake Sammamish.

The OHWM for Lake Sammamish was not field-delineated for this project because it was outside of the trail right-of-way and will not be directly affected. Instead, King County 2010 open water geographic information system (GIS) data were used to determine the OHWM and shoreline setback area.

## 2.8 Fish and Wildlife Habitat Conservation Areas

According to SMC 21A.15.468, the City of Sammamish defines FWHCAs as those areas that are essential for the preservation of critical habitats and species. All areas within the city of Sammamish meeting one or more of the following criteria are designated FWHCAs:

- (1) Areas with which state or federally designated endangered, threatened, and sensitive species have a primary association.
  - (a) Federally designated endangered and threatened species are those fish and wildlife species identified by the USFWS and the National Marine Fisheries Service (NMFS) that are in danger of extinction or are threatened to become endangered. The USFWS and the NMFS should be consulted as necessary for current listing status;
  - (b) State-designated endangered, threatened, and sensitive species are those fish and wildlife species native to the coastal region of the Pacific Northwest identified by the WDFW that are in danger of extinction, threatened to become endangered, vulnerable, or declining and are likely to become endangered or threatened in a significant portion of their range within the state without cooperative management or removal of threats. State-designated

Exhibit 16

SSDP2016-00415

000722 2-5

- endangered, threatened, and sensitive species are periodically recorded in WAC 232-12-014 (state endangered species), and WAC 232-12-011 (state threatened and sensitive species). WDFW maintains the most current listing and should be consulted as necessary for current listing status;
- (2) Wetlands, streams, and lakes;
  - (3) State natural area preserves and natural resource conservation areas. Natural area preserves and natural resource conservation areas are defined, established, and managed by the WDNR; and
  - (4) Fish and wildlife habitat corridors as defined in SMC 21A.15.469.

## 2.9 Critical Aquifer Recharge Areas

According to SMC 21A.15.253, the City of Sammamish defines CARAs as those areas with a critical recharging effect on aquifers used for potable water as defined by WAC 365-190-030(2). CARAs have prevailing geologic conditions associated with infiltration rates that create a high potential for contamination of groundwater resources or contribute significantly to the replenishment of groundwater. CARAs are classified based on the following criteria:

- (1) Class 1 CARAs include those areas located within the mapped 1- or 5-year capture zone of a wellhead protection area.
- (2) Class 2 CARAs include those areas located within the mapped 10-year capture zone of a wellhead protection area.
- (3) Class 3 CARAs include those areas outside wellhead protection areas that are identified as high aquifer recharge potential areas based on characteristics of surficial geology and soil types.

## 2.10 Impact Assessment

Impacts on wetlands, streams, and their buffers (including shoreline setback) were assessed by overlaying the proposed design onto project base maps showing wetland, stream, and buffer locations. Impact areas were determined as the area of intersection between the proposed design and the base maps. This assessment also considered loss of wetland and stream function (based on the amount of clearing, filling, and/or excavation as a result of the project) and other direct and indirect impacts on wetlands and streams.



## 3. RESULTS

The following sections describe critical areas in the project limits. Also included are descriptions of individual wetlands, streams, and FWHCAs identified in the project area.

### 3.1 Landscape Setting

This trail project alignment roughly parallels the eastern shoreline of Lake Sammamish (to the west) and East Lake Sammamish Parkway (to the east) in the East Lake Sammamish Basin, which is in the Upper Sammamish River Drainage in the Cedar/Sammamish Watershed (Water Resource Inventory Area [WRIA] 8) (Williams et al. 1975; Ecology 2008). Streams in the East Lake Sammamish Basin generally originate in wetlands located on the Sammamish Plateau, and drain west through steep ravines to Lake Sammamish. This basin is further divided into several small subbasins. South Sammamish Segment B is within the Monohon, Pine Lake, Thompson, Inglewood, and Panhandle subbasins (Figure 3-1).

The East Lake Sammamish area is located on the eastern side of the Seattle metropolitan area and is rapidly becoming a densely urban area. The City of Sammamish was incorporated in 1999 from lands that were formerly unincorporated King County, and has increased rapidly in population growth with both residential and business development.

The City of Sammamish critical area maps identify Lake Sammamish, six streams, and one wetland in the vicinity of SE 8th Street within the project area. The NWI maps identify Lake Sammamish and one palustrine scrub-shrub wetland west of the vicinity of SE 22nd Place within the project area. Additional wetlands are mapped east of East Lake Sammamish Parkway.

The NRCS Soil Survey for King County Area (Snyder et al. 1973) identifies five soil mapping units within the project area: Seattle muck, which NRCS identifies as a hydric soil; Kitsap silt loam (2 to 8 percent slopes), and Kitsap silt loam (15 to 30 percent slopes), which are identified as partially hydric; and Alderwood gravelly sandy loam (15 to 30 percent slopes) and Alderwood and Kitsap soils (very steep), which are not identified as a hydric soil.

### 3.2 Wetlands

Project biologists delineated 37 wetlands in the project area (Figures 3-2a through 3-2g). Table 3-1 provides a summary of characteristics for all wetlands. A summary of wetland functions and values (Table 3-2), along with detailed descriptions for wetlands identified and delineated by Parametrix, are provided below.

**Table 3-1. Summary of Wetlands in the Project Vicinity**

Wetland	Size (acres)	Ecology/Sammamish Rating <sup>a</sup>	Buffer Width <sup>b</sup> (feet)	USFWS Class <sup>c</sup>	HGM Class <sup>d</sup>
15A	~0.10	III	50	PFO/PEM	Lake-Fringe/Slope
15BC	~0.15	IV	50	PFO/PEM	Depressional/Riverine/Slope
15D	0.05	IV	50	PEM	Depressional
15E	0.05	IV	50	PEM	Depressional
18C	0.02	III	50	PSS	Depressional
19A	0.01	IV	50	PEM	Depressional
19B	~0.36	III	50	PSS/PEM	Lake-Fringe/Slope
20A	0.05	III	50	PEM	Depressional/Slope
21AC	~0.40	III	50	PEM	Lake-Fringe/Slope
21B	~0.08	III	50	PFO/PSS	Depressional
21D	~0.15	IV	50	PEM	Depressional/Slope
22AB	0.46	III	50	PFO/PSS/PEM	Depressional/Slope
22CD	0.06	IV	50	PSS/PEM	Depressional/Slope
22E	<0.01	IV	50	PEM	Depressional
23A	0.03	IV	50	PEM	Depressional/Slope
23B	~0.05	III	50	PSS/PEM	Lake-Fringe/Slope
23C	0.09	III	50	PSS/PEM	Depressional
24A	0.60	III	50	PFO/PSS/PEM	Depressional/Riverine
24B	~1.75	III	50	PFO/PSS	Depressional/Riverine
24C	0.16	III	50	PFO/PEM	Depressional/Riverine
25A	0.25	III	50	PFO	Depressional/Riverine
25B	0.33	III	50	PFO/PSS/PEM	Depressional
25C	0.25	III	50	PFO/PEM	Depressional
25F	0.06	III	50	PFO	Depressional
26A	0.91	III	50	PFO/PSS/PEM	Depressional/Riverine
26B	0.02	IV	50	PEM	Slope
26C	0.03	IV	50	PSS/PEM	Depressional
26D	~0.13	III	50	PSS/PEM	Riverine/Lake Fringe
28A	0.08	IV	50	PFO	Depressional/Riverine
28B	0.02	IV	50	PSS	Depressional/Slope
28C	0.02	IV	50	PSS/PEM	Depressional
28D	<0.01	IV	50	PEM	Depressional
28E	0.02	III	50	PEM	Depressional
29B	~0.03	IV	50	PEM	Slope
29C	~0.06	III	50	PFO	Lake-Fringe/Slope
29D	0.08	IV	50	PSS/PEM	Depressional/Slope
30B	0.20	III	50	PFO	Depressional/Slope

<sup>a</sup> Hruby (2004), as specified in SMC 21A.50.290

<sup>b</sup> SMC 21A.50.290

<sup>c</sup> Cowardin et al. (1979) classification

PEM = palustrine emergent

PFO = palustrine forested

PSS = palustrine scrub-shrub

<sup>d</sup> Brinson (1993); HGM = hydrogeomorphic

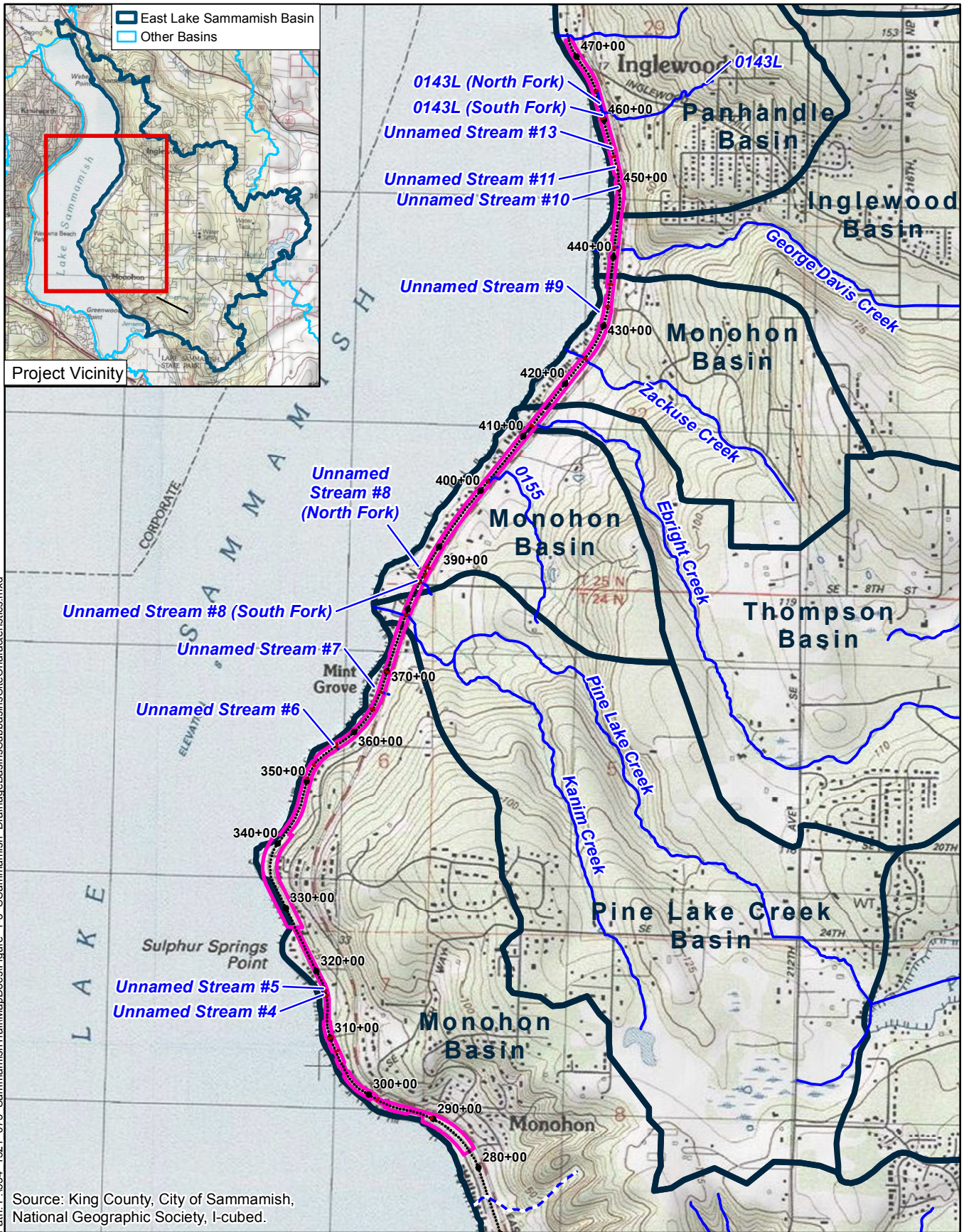

Path: P:\954\_1521\_075\_Sammamish\_TrailMapDocs\Figure\_1-3\_Sammamish\_DrainageBasinsSubbasinsSiteCharacteristics.mxd

Source: King County, City of Sammamish, National Geographic Society, I-cubed.

**Parametrix**

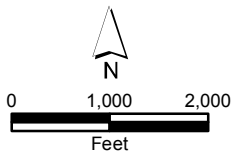

- ▭ South Sammamish Segment B Project Location
- Stream Crossing Field-verified by Parametrix
- - - Stream Crossing Not Found within Trail Corridor
- City of Sammamish Drainage Basin

- 480+00      485+00
- ● ● ● ●
- Proposed Trail Stationing

**Figure 3-1  
Drainage Basins,  
Subbasins, and Site  
Characteristics**

Exhibit 16  
SDDP 2016-00443  
00516



Path: P:\1554\_1521\_075\_SammamishTrailMapDocs\Sammamish\_Segment\_B\_CriticalAreas.mxd

Service Layer Credits: Source: Esri, DigitalGlobe, GeoEye, Earthstar Geographics, CNES/Airbus DS, USDA, USGS, AEX, Getmapping, Aerogrid, IGN, IGP, swisstopo, and the GIS User Community

Parametrix

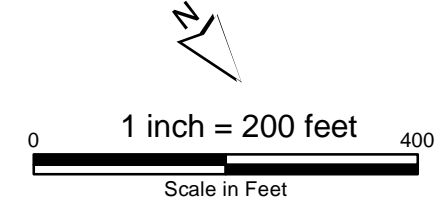

- |                              |                             |                                  |
|------------------------------|-----------------------------|----------------------------------|
| Proposed Trail               | Delineated Wetland Boundary | Culvert                          |
| Wetland                      | Stream                      | Class 3 Wellhead Protection Zone |
| Stream Buffer                | Lake OHWM                   | Group B Well                     |
| Wetland Buffer               | Shoreline Setback           | Project Right of Way             |
| Wetland and Buffer Continues |                             |                                  |

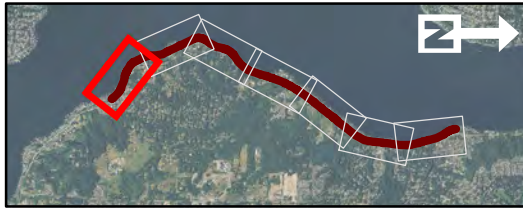

**Figure 3-2a**  
**Critical Areas Map**  
**East Lake Sammamish Master Plan Trail**  
**South Sammamish -**  
**Segment B**



Path: P:\1554\_1521\_075\_SammamishTrailMapDocs\Sammamish\_Segment\_B\_CriticalAreas.mxd

Service Layer Credits: Source: Esri, DigitalGlobe, GeoEye, Earthstar Geographics, CNES/Airbus DS, USDA, USGS, AEX, Getmapping, Aerogrid, IGN, IGP, swisstopo, and the GIS User Community

Parametrix

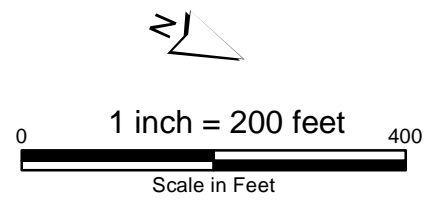

- |                              |                             |                                  |
|------------------------------|-----------------------------|----------------------------------|
| Proposed Trail               | Delineated Wetland Boundary | Culvert                          |
| Wetland                      | Stream                      | Class 3 Wellhead Protection Zone |
| Stream Buffer                | Lake OHWM                   | Group B Well                     |
| Wetland Buffer               | Shoreline Setback           | Project Right of Way             |
| Wetland and Buffer Continues |                             |                                  |



**Figure 3-2b**  
**Critical Areas Map**  
**East Lake Sammamish Master Plan Trail**  
**South Sammamish -**  
**Segment B**



Path: P:\1554\_1521\_075\_SammamishTrail\MapDocs\Sammamish\_Segment\_B\_CriticalAreas.mxd

Service Layer Credits: Source: Esri, DigitalGlobe, GeoEye, Earthstar Geographics, CNES/Airbus DS, USDA, USGS, AEX, Getmapping, Aerogrid, IGN, IGP, swisstopo, and the GIS User Community

Parametrix

- Proposed Trail
- Wetland
- Stream Buffer
- Wetland Buffer
- Delineated Wetland Boundary
- Stream
- Lake OHWM
- Shoreline Setback
- Culvert
- Class 3 Wellhead Protection Zone
- Group B Well
- Project Right of Way
- Wetland and Buffer Continues



**Figure 3-2c**  
**Critical Areas Map**  
**East Lake Sammamish Master Plan Trail**  
**South Sammamish -**  
**Segment B**



Path: P:\1554\_1521\_075\_SammamishTrailMap\Docs\Sammamish\_Segment\_B\_CriticalAreas.mxd

Service Layer Credits: Source: Esri, DigitalGlobe, GeoEye, Earthstar Geographics, CNES/Airbus DS, USDA, USGS, AEX, Getmapping, Aerogrid, IGN, IGP, swisstopo, and the GIS User Community

Parametrix

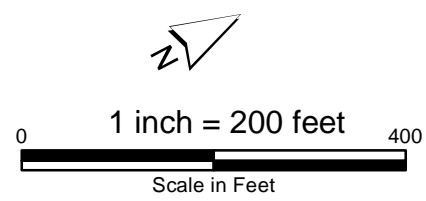

- Proposed Trail
- Wetland
- Stream Buffer
- Wetland Buffer
- Wetland and Buffer Continues
- Delineated Wetland Boundary
- Stream
- Lake OHWM
- Shoreline Setback
- Culvert
- Class 3 Wellhead Protection Zone
- Group B Well
- Project Right of Way



**Figure 3-2d**  
**Critical Areas Map**  
**East Lake Sammamish Master Plan Trail**  
**South Sammamish -**  
**Segment B**



Path: P:\1554\_1521\_075\_Sammamish Trail\MapDocs\Sammamish\_Segment\_B\_CriticalAreas.mxd

Service Layer Credits: Source: Esri, DigitalGlobe, GeoEye, Earthstar Geographics, CNES/Airbus DS, USDA, USGS, AEX, Getmapping, Aerogrid, IGN, IGP, swisstopo, and the GIS User Community

Parametrix

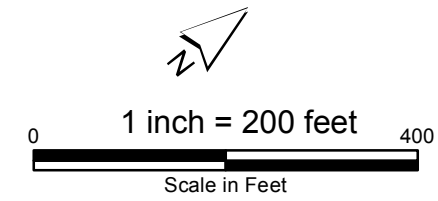

- |                              |                             |                                  |
|------------------------------|-----------------------------|----------------------------------|
| Proposed Trail               | Delineated Wetland Boundary | Culvert                          |
| Wetland                      | Stream                      | Class 3 Wellhead Protection Zone |
| Stream Buffer                | Lake OHWM                   | Group B Well                     |
| Wetland Buffer               | Shoreline Setback           | Project Right of Way             |
| Wetland and Buffer Continues |                             |                                  |

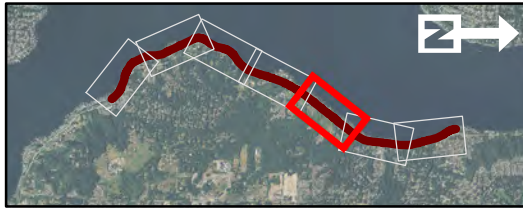

**Figure 3-2e**  
**Critical Areas Map**  
**East Lake Sammamish Master Plan Trail**  
**South Sammamish -**  
**Segment B**





Path: P:\1554\_1521\_075\_Sammamish Trail\MapDocs\Sammamish\_Segment\_B\_CriticalAreas.mxd

Parametrix

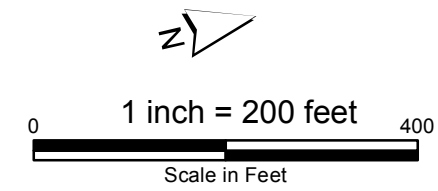

- Proposed Trail
- Delineated Wetland Boundary
- Stream
- Culvert
- Wetland
- Stream Buffer
- Lake OHWM
- Class 3 Wellhead Protection Zone
- Wetland Buffer
- - - Shoreline Setback
- Group B Well
- Project Right of Way
- Wetland and Buffer Continues

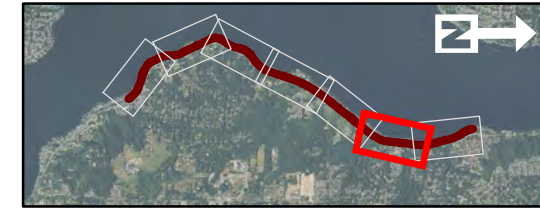

**Figure 3-2f**  
**Critical Areas Map**  
**East Lake Sammamish Master Plan Trail**  
**South Sammamish -**  
**Segment B**

Service Layer Credits: Source: Esri, DigitalGlobe, GeoEye, Earthstar Geographics, CNES/Airbus DS, USDA, AeroGRID, IGN, IGP, swisstopo, and the GIS User Community



Path: P:\1554\_1521\_075\_SammamishTrail\MapDocs\Sammamish\_Segment\_B\_CriticalAreas.mxd

Parametrix

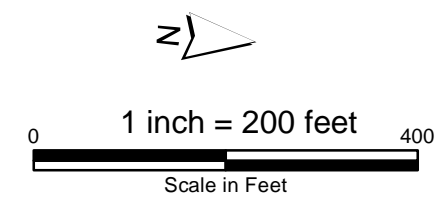

- Proposed Trail
- Wetland
- Stream Buffer
- Wetland Buffer
- Wetland and Buffer Continues
- Delineated Wetland Boundary
- Stream
- Lake OHWM
- - - Shoreline Setback
- Culvert
- Class 3 Wellhead Protection Zone
- Group B Well
- Project Right of Way

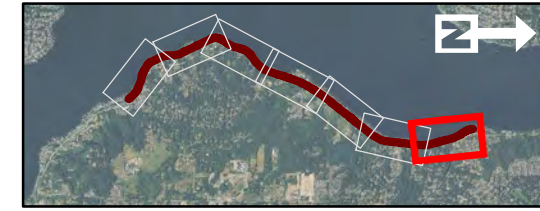

**Figure 3-2g**  
**Critical Areas Map**  
**East Lake Sammamish Master Plan Trail**  
**South Sammamish -**  
**Segment B**

Service Layer Credits: Source: Esri, DigitalGlobe, GeoEye, Earthstar Geographics, CNES/Airbus DS, USDA, USGS, AEX, Getmapping, Aerogrid, IGN, IGP, swisstopo, and the GIS User Community

Table 3-2. Summary of Wetland Functions and Values for Wetlands in the Project Area Identified by Parametrix

Wetland	HGM Class	Flood Flow Alteration	Sediment Removal	Nutrient and Toxicant Removal	Erosion Control and Shoreline Stabilization	Production of Organic Matter and its Export	General Habitat Suitability	Habitat for Aquatic Invertebrates	Habitat for Amphibians	Habitat for Wetland-Associated Mammals	Habitat for Wetland-Associated Birds	General Fish Habitat	Native Plant Richness	Educational or Scientific Value	Uniqueness and Heritage
15A	Lake-Fringe/Slope	L	L	L	L	L	L	L	L	L	L	L	-	-	-
15BC	Depressional/Riverine/Slope	L	L	L	L	L	L	L	L	-	-	L	-	-	-
15D	Depressional	L	M	M	-	L	-	M	L	-	-	-	L	-	-
15E	Depressional	L	M	M	-	L	-	M	L	-	-	-	L	-	-
18C	Depressional	L	L	L	-	-	L	L	L	-	-	-	L	-	-
19A	Depressional	-	L	L	-	L	-	L	L	-	-	-	-	-	-
19B	Lake-Fringe/Slope	L	-	L	L	L	L	L	L	L	L	L	-	-	-
20A	Depressional/Slope	L	L	L	-	L	-	L	L	-	-	-	-	-	-
21AC	Lake-Fringe/Slope	L	-	L	L	L	L	L	L	L	L	L	-	-	-
21B	Depressional	L	M	L	-	L	L	L	L	-	-	-	L	-	-
21D	Depressional/Slope	-	L	L	-	L	L	L	L	-	-	-	-	-	-
22AB	Depressional/Slope	M	M	M	L	M	M	L	L	-	-	-	-	-	-
22CD	Depressional/Slope	L	L	L	-	L	L	L	L	-	-	-	-	-	-
22E	Depressional	L	L	L	-	-	-	-	-	-	-	-	-	-	-
23A	Depressional/Slope	L	L	L	-	L	L	L	L	-	-	-	-	-	-
23B	Lake-Fringe/Slope	L	-	L	L	L	L	L	L	L	L	L	-	-	-
23C	Depressional	L	L	L	-	-	L	L	L	-	-	-	-	-	-
24A	Depressional/Riverine	M	L	L	M	H	M	M	L	-	-	M	-	-	-
24B	Depressional/Riverine	M	M	M	M	M	M	M	M	L	-	M	-	-	-
24C	Depressional/Riverine	L	L	L	L	M	M	M	M	-	-	L	-	-	-
25A	Depressional/Riverine	M	M	M	M	M	M	M	M	L	-	M	-	-	-
25B	Depressional	L	M	M	-	M	M	L	L	-	-	-	-	-	-
25C	Depressional	L	L	L	-	L	M	L	L	-	-	-	-	-	-
25F	Depressional	L	L	L	L	L	L	-	-	-	-	L	-	-	-
26A	Depressional/Riverine	L	L	L	L	L	M	L	L	-	-	L	-	-	-
26B	Slope	-	-	-	-	-	-	-	-	-	-	-	-	-	-
26C	Depressional	L	L	L	-	-	L	-	-	-	-	-	-	-	-
26D	Riverine/Lake-Fringe	L	L	L	L	L	L	L	L	L	L	L	L	-	-
28A	Depressional/Riverine	L	L	L	M	M	L	M	L	-	-	L	-	-	-
28B	Depressional/Slope	-	-	-	-	L	-	-	-	-	-	-	-	-	-
28C	Depressional	L	L	L	-	L	L	L	L	-	-	-	-	-	-
28D	Depressional	-	-	-	M	M	-	-	-	-	-	-	-	-	-
28E	Depressional	L	L	L	-	-	-	-	-	-	-	-	-	-	-
29B	Slope	-	-	-	-	-	-	-	-	-	-	-	-	-	-
29C	Lake-Fringe/Slope	-	L	L	L	M	L	L	L	L	L	L	L	-	-
29D	Depressional/Slope	L	L	L	L	M	L	-	-	-	-	-	L	-	-
30B	Depressional/Slope	L	L	M	-	M	M	M	M	-	-	M	H	-	-

H = high  
 M = moderate  
 L = low  
 - = Does not provide this function

## Wetland 15A

Subbasin: Monohon

USFWS Classification: Palustrine Forested/Palustrine Emergent

HGM Classification: Lake-Fringe/Slope

Ecology Rating: Category III

City of Sammamish Rating: Category III

Data Plots: 15A-SP1, 15A-SP2

Stations: 317+00 to 318+25

Size: Approximately 0.10 acre

---

Wetland 15A is associated with Lake Sammamish, located primarily in a maintained residential lawn on the west side of the trail approximately 100 feet south of East Lake Sammamish Shore Lane SE and the intersection of East Lake Sammamish Parkway and SE 26th Street (see Figure 3-2b). Wetland 15A extends outside the project area to the west, down to the lake.

## Hydrology

Wetland hydrology is primarily maintained by groundwater seeps along the hill slope, a stream (Unnamed Stream 5), and Lake Sammamish. Unnamed Stream 5 flows from a culvert under the trail (connecting to Wetland 15BC), contributing through flow to the wetland, prior to connecting downstream with Lake Sammamish. The stream appears to be perennial with water flowing during the September 2013 field visit. Saturation in the upper 12 inches of the soil profile was observed during site visits conducted in October 2007 and March 2014. Outside of Lake Sammamish and Unnamed Stream 5, this wetland has a saturated-only water regime.

## Vegetation

Wetland 15A has two vegetation communities: forested and emergent. The forested community is dominated by western redcedar (*Thuja plicata*), black cottonwood (*Populus balsamifera*), and red alder (*Alnus rubra*) in the overstory and salmonberry (*Rubus spectabilis*) and English ivy (*Hedera helix*) in the understory. Other species observed include Oregon ash (*Fraxinus latifolia*), Douglas fir (*Pseudotsuga menziesii*), cherry (*Prunus* spp.), Indian plum (*Oemleria cerasiformis*), slough sedge (*Carex obnupta*), western swordfern (*Polystichum munitum*), and hedge false bindweed (*Calystegia sepium*). The emergent community is dominated by maintained lawn, reed canarygrass (*Phalaris arundinacea*), and giant horsetail (*Equisetum telmateia*).

## Soils

Soil in Wetland 15A was examined to a depth of 16 inches and consists of two layers. The upper layer is a 14-inch layer of black (10YR 2/1) silt loam with gravel. The lower layer is a black (10YR 2/1) silt loam. High organic content was present throughout the profile. Soil in the area is mapped as Alderwood gravelly sandy loam.

## Buffer

Wetland 15A is situated in a residentially developed area with single-family houses and associated yards to the north, east, and south. Lake Sammamish borders the wetland to the west. Wetland buffer consists of maintained lawn, scattered trees, and shrubs including red alder, western redcedar, and redwood (*Sequoia* sp.). The buffer between Wetland 15A and the trail is primarily composed of herbaceous vegetation and a row of arborvitae (*Thuja occidentalis*). Wetland 15BC is located on the east side of the trail.

## Wetland Classification

Wetland 15A is classified as a palustrine forested/palustrine emergent wetland under the Cowardin et al. (1979) system and a lake-fringe/slope wetland under the HGM system (Null et al. 2000; Hruby 2004). Wetland 15A is rated a Category III according to the City of Sammamish and Ecology. This wetland scored 42 points on the Washington State Wetland Rating System for Western Washington rating form (18 points for water quality functions, 8 point for hydrologic functions, and 16 points for habitat functions) (see Appendix B). The required buffer width is 50 feet for Category III wetlands scoring less than 20 points for habitat functions in the city of Sammamish (SMC 21A. 50. 290).

## Wetland Determination

Biologists flagged the boundary of Wetland 15A where indicators of hydrophytic vegetation, hydric soils, and wetland hydrology were present. The wetland edge generally corresponds with a topographic break where one or more of the wetland indicators was lacking.

### *Wetland 15BC*

Subbasin: Monohon

USFWS Classification: Palustrine Forested/Palustrine Emergent

HGM Classification: Depressional/Riverine/Slope

Ecology Rating: Category IV

City of Sammamish Rating: Category IV

Data Plots: 15C-SP1

Stations: 315+50 to 319+25

Size: Approximately 0.15 acre

---

Wetland 15BC<sup>1</sup> is the southernmost wetland in the project area. It is located primarily in a maintained residential lawn on the east side of the trail approximately 100 feet south of East Lake Sammamish Shore Lane SE and the intersection of East Lake Sammamish Parkway and SE 26th Street (see Figure 3-2b). Wetland 15BC extends outside the project area to the east.

## Hydrology

Wetland hydrology is maintained by groundwater seeps from the slope to the east and through flow from two perennial streams (Unnamed Streams 4 and 5). The wetland outlets via the two streams that flow through separate culverts under the trail, eventually entering Lake Sammamish to the west. A culvert passes under a filled area connecting two portions of this wetland and conveying flow from Unnamed Stream 5<sup>1</sup>. Unnamed Stream 5 provides a surface water connection from Wetland 15BC to Wetland 15A. Soils were saturated in the upper 12 inches and to the surface in areas during the site visits in 2007 and 2014. This wetland has a saturated only water regime.

## Vegetation

Wetland 15BC has two vegetation communities: forested and emergent. There are two forested communities; one is dominated by corkscrew willow (*Salix matsudana*) with one horse chestnut (*Aesculus hippocastanum*) and one Lombardy poplar (*Populus nigra*), and the other is dominated by red alder, Oregon ash, and a large overhanging weeping willow (*Salix babylonica*). The understory is composed of salmonberry, common ladyfern (*Athyrium filix-femina*), reed canarygrass, creeping

---

<sup>1</sup> Wetland 15BC was identified as two separate wetlands (Wetlands 15B and 15C) during the initial wetland delineations (Parametrix 2005).

buttercup (*Ranunculus repens*), small-fruited bulrush (*Scirpus microcarpus*), common rush (*Juncus effusus*), giant horsetail, fringed willowherb (*Epilobium ciliatum*), grasses, watercress (*Nasturtium officinale*), different leaved water-starwort (*Callitriche heterophylla*), and few western swordfern. The emergent community consists of grass (mowed lawn), reed canarygrass, common rush, small-fruited bulrush, skunk cabbage (*Lysichiton americanus*), giant horsetail, ladyfern, hedge false bindweed, and fringed willowherb.

## Soils

Soil examined in Wetland 15BC consists of a single 17-inch layer of a very dark gray (10YR 3/1) silt loam. Soil in the area is mapped as Alderwood gravelly sandy loam.

## Buffer

The area surrounding Wetland 15BC is developed with single-family residences and associated yards. Directly to the east of the wetland is a sloped yard dominated by mowed grass. A few scattered trees lie to the northeast and southeast. Vegetation in the buffer includes ornamental shrubs, Douglas fir, and western redcedar. The vegetation between the wetland and trail consists of a laurel hedge, grasses, and ornamental shrubs.

## Wetland Classification

Wetland 15BC is classified as a palustrine forested/palustrine emergent wetland under the Cowardin et al. (1979) system and depressional/riverine/slope under the HGM system (Null et al. 2000; Hruby 2004). Wetland 15BC is rated a Category IV according to the City of Sammamish and Ecology. This wetland scored 27 points on the Washington State Wetland Rating System for Western Washington rating form (4 points for water quality functions, 10 points for hydrologic functions, and 13 points for habitat functions) (see Appendix B). The required buffer width is 50 feet for Category IV wetlands in the city of Sammamish (SMC 21A.50.290).

## Wetland Determination

Biologists flagged the boundary of Wetland 15BC where indicators of hydrophytic vegetation, hydric soils, and wetland hydrology were present. The wetland edge generally corresponds with a topographic break where one or more of the wetland indicators was lacking.

### *Wetland 15D*

Subbasin: Monohon

USFWS Classification: Palustrine Emergent

HGM Classification: Depressional

Ecology Rating: Category IV

City of Sammamish Rating: Category IV

Data Plots: 15D-SP1, 15D-SP2

Stations: 320+75 to 325+75

Size: 0.05 acre

---

Wetland 15D is a maintained swale bounded by the fill slope of the trail and a cut slope immediately east of the trail, north of SE 26th Street (see Figure 3-2b). This swale is vegetated with herbaceous species, but receives periodic clearing and dredging. It functions as a ditch conveying water along the trail to downgradient aquatic systems. This wetland is located entirely within the project area.

## Hydrology

Wetland hydrology is supported by groundwater discharge, seasonally high groundwater, and local area runoff. Surface water from Wetland 15E is also conveyed to Wetland 15D from a pipe at the north end and a pipe at the south end. Wetland 15D is on a crest sending some surface water north and some south. Water flowing north exits through a culvert under a private driveway, then goes into a grassy swale where some water appears to infiltrate and some is conveyed farther north via a small corrugated pipe. Water flowing south exits through a culvert under SE 26th Street, then continues south in a ditch to Wetland BC. Surface water from Wetland BC flows under the trail to Lake Sammamish. Saturation to the surface and inundation were observed during the January 2009 and September 2013 field investigations. This wetland has permanently flooded, seasonally flooded, and saturated only water regimes.

## Vegetation

Wetland 15D has an emergent community that is periodically maintained. Dominant species include different leaved water-starwort, common duckweed (*Lemna minor*), creeping buttercup, small-fruited bulrush, and English ivy (encroaching from the adjacent upland slope). Other species observed include reed canarygrass, American speedwell (*Veronica americana*), common rush, watercress, ladyfern, rough bluegrass (*Poa trivialis*), red fescue (*Festuca rubra*), birdsfoot trefoil (*Lotus corniculatus*), and little western bittercress (*Cardamine oligosperma*).

## Soils

Soils examined in Wetland 15D were a black (N 2.5/1) loamy sand over a very dark greenish gray (10Y 3/1) sand. Gravels and cobbles were present throughout the profile. Soil in the area is mapped as Alderwood gravelly sandy loam.

## Buffer

The wetland is in a residential area surrounded by single-family residences and associated yards. A private driveway, SE 26th Street, and the trail border the wetland to the north, south, and west that have a narrow maintained herbaceous layer. Portions of the slope to the east have a rock or concrete retaining wall. Although narrow, there is a vegetated buffer to the east that is dominated by Himalayan blackberry and English ivy. Other species include hedge false bindweed, rose (*Rosa* sp.), laurel, beaked hazelnut (*Corylus cornuta*), bigleaf maple (*Acer macrophyllum*), and little western bittercress. Connectivity to other wetlands is inhibited by development.

## Wetland Classification

Wetland 15D is classified as a palustrine emergent wetland under the Cowardin et al. (1979) system and a depressional wetland under the HGM system (Null et al. 2000; Hruby 2004). Wetland 15D is rated a Category IV according to the City of Sammamish and Ecology. This wetland scored 29 points on the Washington State Wetland Rating System for Western Washington rating form (8 points for water quality functions, 10 points for hydrologic functions, and 11 points for habitat functions) (see Appendix B). The required buffer width is 50 feet for Category IV wetlands in the city of Sammamish (SMC 21A.50.290).

## Wetland Determination

Biologists flagged the boundary of Wetland 15D where indicators of hydrophytic vegetation, hydric soils, and wetland hydrology were present. The wetland edge generally corresponds with a topographic break where one or more of the wetland indicators was lacking.

## Wetland 15E

Subbasin: Monohon

USFWS Classification: Palustrine Emergent

HGM Classification: Depressional

Ecology Rating: Category IV

City of Sammamish Rating: Category IV

Data Plots: 15E-SP1, 15E-SP2

Stations: 320+75 to 324+75

Size: 0.05 acre

Wetland 15E is a maintained swale bounded by the fill slope of the trail and a cut slope immediately west of the trail, north of SE 26th Street (see Figure 3-2b). This swale is vegetated with herbaceous species, but receives periodic clearing and dredging. It functions as a ditch conveying water along the trail to downgradient aquatic systems. This wetland is located entirely within the project area.

### Hydrology

Wetland hydrology is supported by high groundwater and local area runoff. Wetland 15E is on a crest sending some surface water north and some south. Culverts at both ends of the wetland convey water under the trail to Wetland 15D. Saturation to the surface and inundation were observed during the January 2009 and September 2013 field investigations. This wetland has permanently flooded and saturated only water regimes.

### Vegetation

Wetland 15E has an emergent community that is periodically maintained. Dominant species include small-fruited bulrush and common duckweed. Other species observed include American speedwell, common rush, ladyfern, different leaved water-starwort, creeping buttercup, rough bluegrass, common velvetgrass (*Holcus lanatus*), giant horsetail, water horsetail (*Equisetum fluviatile*), watercress, common cattail (*Typha latifolia*), fringed willowherb, reed canarygrass, and birdsfoot trefoil.

### Soils

Soil examined in Wetland 15E was a black (10YR 2/1) sandy silt loam. Decomposing organic matter and gravel were present throughout the profile. Soil in the area is mapped as Alderwood gravelly sandy loam.

### Buffer

The wetland is in a residential area surrounded by single-family residences and associated yards. A private driveway, SE 26th Street, and the trail border the wetland to the north, south, and east that have a narrow maintained herbaceous layer. A row of arborvitae with mulch is located to the north between the wetland and the private driveway. Although narrow, there is a vegetated buffer to the west that contains small patches of trees dominated by Douglas fir, bigleaf maple, western redcedar, and an ornamental fruit tree. The understory is dominated by salal (*Gaultheria shallon*), western swordfern, and English ivy. Other species include Himalayan blackberry (*Rubus armeniacus*), beaked hazelnut, bracken fern (*Pteridium aquilinum*), creeping buttercup, red fescue, reed canarygrass, and hedge false bindweed. Connectivity to other wetlands is inhibited by development.

### Wetland Classification

Wetland 15E is classified as a palustrine emergent wetland under the Cowardin et al. (1979) system and a depressional wetland under the HGM system (Null et al. 2000; Hruby 2004). Wetland 15E is rated a

Exhibit 16  
SSDP2016-00415  
000739



Category IV according to the City of Sammamish and Ecology. This wetland scored 28 points on the Washington State Wetland Rating System for Western Washington rating form (4 points for water quality functions, 14 points for hydrologic functions, and 10 points for habitat functions) (see Appendix B). The required buffer width is 50 feet for Category IV wetlands in the city of Sammamish (SMC 21A.50.290).

## Wetland Determination

Biologists flagged the boundary of Wetland 15E where indicators of hydrophytic vegetation, hydric soils, and wetland hydrology were present. The wetland edge generally corresponds with a topographic break where one or more of the wetland indicators was lacking.

### Wetland 18C

Subbasin: Monohon

USFWS Classification: Palustrine Scrub-Shrub

HGM Classification: Depressional

Ecology Rating: Category III

City of Sammamish Rating: Category III

Data Plots: 18C-SP1, 18C-SP2

Stations: 330+75 to 331+75

Size: 0.02 acre

---

Wetland 18C is located in a ravine on the east side of the trail in a residentially developed area bounded to the north and south by residential yards (see Figure 3-2b). This wetland is located entirely within the project area.

## Hydrology

Wetland hydrology is maintained by local area runoff from slopes to the east and north and seasonally high groundwater. The wetland is a closed depression with no outlet. Soil saturation in the upper 12 inches was observed during the October 2007 site visit and standing water (measured 8 inches) was present during the March 2014 site visit. This wetland has a seasonally flooded water regime.

## Vegetation

Wetland 18C is a scrub-shrub wetland community dominated by red-osier dogwood (*Cornus sericea*). Sub-dominant vegetation includes Oregon ash, Himalayan blackberry, common scouring rush (*Equisetum hyemale*), and slough sedge.

## Soils

Soil in Wetland 18C was examined to a depth of 18 inches and consists of three layers. The surface layer is a 6-inch layer of very dark gray (10YR 3/1) silt loam. The subsurface layers are a 6-inch layer of very dark gray (10YR 3/1) gravelly silt loam with light red (2.5Y 6/6) redoximorphic features over a 6-inch layer of dark gray (10YR 4/1) gravelly sandy loam. Soil in the area is mapped as mixed alluvial land.

## Buffer

Wetland 18C is surrounded by single-family residential development. A sloped yard is to the east of the wetland and is dominated by English ivy. The slope to the west of the wetland is partially landscaped (near trail), but most is dominated in the understory by Himalayan blackberry with Pacific madrone (*Arbutus menziesii*), Douglas fir (on lake side of trail), bigleaf maple, western swordfern, and beaked hazelnut.

## Wetland Classification

Wetland 18C is classified as a palustrine scrub-shrub wetland under the Cowardin et al. (1979) system and depressional under the HGM system (Null et al. 2000; Hruby 2004). Wetland 18C is rated a Category III according to the City of Sammamish and Ecology. This wetland scored 46 points on the Washington State Wetland Rating System for Western Washington rating form (24 points for water quality functions, 14 points for hydrologic functions, and 8 points for habitat functions) (see Appendix B). The required buffer width is 50 feet for Category III wetlands scoring less than 20 points for habitat functions in the city of Sammamish (SMC 21A.50.290).

## Wetland Determination

Biologists flagged the boundary of Wetland 18C where indicators of hydrophytic vegetation, hydric soils, and wetland hydrology were present. The wetland edge generally corresponds with a topographic break where one or more of the wetland indicators was lacking.

### *Wetland 19A*

Subbasin: Monohon

USFWS Classification: Palustrine Emergent

HGM Classification: Depressional

Ecology Rating: Category IV

City of Sammamish Rating: Category IV

Data Plots: 19A-SP1

Stations: 347+50 to 348+25

Size: 0.01 acre

---

Wetland 19A is primarily a vegetated ditch located on the east side of the trail in a residential area between the trail and East Lake Sammamish Place SE (see Figure 3-2c). This wetland is located entirely within the project area.

## Hydrology

Hydrology is supported by local area runoff and groundwater seeps from the slope to the east. Inundation of 5 inches was observed in the ditch during site visits conducted in November 2007, and saturated soils within the upper 12 inches were observed in September 2013. This wetland has seasonally flooded and saturated only water regimes. No outlet was observed.

## Vegetation

Wetland 19A is an emergent wetland community. Dominant vegetation is reed canarygrass. Other vegetation present includes common velvetgrass, common rush, giant horsetail, Himalayan blackberry, hedge false bindweed, purple loosestrife (*Lythrum salicaria*), and Oregon ash.

## Soils

Soil in Wetland 19A was examined to a depth of 18 inches and consists of two layers—a very dark gray (7.5YR 3/1) silt loam over a dark gray (2.5Y 4/1) silt loam with light olive brown (2.5Y 5/6) redoximorphic features. Soil in the area is mapped as Alderwood gravelly sandy loam.

## Buffer

Wetland 19A is situated in a residentially developed area with minimal functional buffer. A steep-sloped yard with mowed grass is to the east of the wetland. The trail lies to the west of the wetland with a

narrow strip of maintained herbaceous vegetation between. The rest of the vegetated buffer includes English ivy, salal, western swordfern, Himalayan blackberry, and hedge false bindweed.

## Wetland Classification

Wetland 19A is classified as a palustrine emergent wetland under the Cowardin et al. (1979) system and depressional under the HGM system (Null et al. 2000; Hruby 2004). Wetland 19A is rated a Category IV according to the City of Sammamish and Ecology. This wetland scored 27 points on the Washington State Wetland Rating System for Western Washington rating form (12 points for water quality functions, 8 points for hydrologic functions, and 7 points for habitat functions) (see Appendix B). The required buffer width is 50 feet for Category IV wetlands in the city of Sammamish (SMC 21A.50.290).

## Wetland Determination

Biologists flagged the boundary of Wetland 19A where indicators of hydrophytic vegetation, hydric soils, and wetland hydrology were present. The wetland edge generally corresponds with a topographic break where one or more of the wetland indicators was lacking.

### *Wetland 19B*

Subbasin: Monohon

USFWS Classification: Palustrine Scrub-Shrub/Palustrine Emergent

HGM Classification: Lake-Fringe/Slope

Ecology Rating: Category III

City of Sammamish Rating: Category III

Data Plots: 19B-SP1, 19B-SP2

Stations: 347+50 to 349+75

Size: Approximately 0.36 acre

---

Wetland 19B is located on the west side of the trail in a residential area between the trail and Lake Sammamish (see Figure 3-2c). Wetland 19B extends outside the project area to the west, and is associated with Lake Sammamish. This wetland is mostly lawn, and has been modified since the 2007 field investigation. The vicinity of the original W19B-SP1 location has been filled, landscaped, and terraced; therefore, a new sample plot (W19B-SP1 (rev)) was documented in March 2014.

## Hydrology

Wetland hydrology is supported by seasonally high groundwater. The wetland drains toward Lake Sammamish. Soil saturation in the upper 12 inches was observed during site visits conducted in October 2007. In March 2014, soil saturation to the surface with standing water in micro-depressions was observed. This wetland has a saturated only water regime.

## Vegetation

Wetland 19B is primarily an emergent wetland community. The wetland is mostly residential lawn dominated by mowed unidentified grass. A small scrub-shrub community occurs along the eastern boundary, dominated by Himalayan blackberry and hedge false bindweed, with some red-osier dogwood and rose.

## Soils

Soil in Wetland 19B was examined to a depth of 19 inches and consists of two layers. The surface layer is a black (10YR 2/1) gravelly sandy loam. The subsurface layer is a dark gray (10YR 4/1) gravelly clay loam

with yellowish brown (10YR 5/8) redoximorphic features. Soil in the area is mapped as Alderwood gravelly sandy loam.

## Buffer

Wetland 19B is located in a residentially developed area and wetland buffer is mostly maintained lawn with some scattered trees and shrubs. Lake Sammamish is adjacent to the wetland to the west. The trail is located to the east of the wetland. Vegetation between the trail and the wetland is mostly landscaped with a row of arborvitae and patches of Himalayan blackberry, English ivy, and salal. Other species include black cottonwood, western swordfern, snowberry, and giant horsetail.

## Wetland Classification

Wetland 19B is classified as a palustrine scrub-shrub/palustrine emergent wetland under the Cowardin et al. (1979) system and lake-fringe/slope under the HGM system (Null et al. 2000; Hruby 2004). Wetland 19B is rated a Category III according to the City of Sammamish and Ecology. This wetland scored 35 points on the Washington State Wetland Rating System for Western Washington rating form (20 point for water quality functions, 4 point for hydrologic functions, and 11 points for habitat functions) (see Appendix B). The required buffer width is 50 feet for Category III wetlands scoring less than 20 points for habitat functions in the city of Sammamish (SMC 21A.50.290).

## Wetland Determination

Wetland 19B was delineated based on the presence of hydric soil and wetland hydrology. Vegetation was not used for delineation because existing vegetation is mowed lawn and may not reflect hydrologic conditions present on the site.

### *Wetland 20A*

Subbasin: Monohon

USFWS Classification: Palustrine Emergent

HGM Classification: Depressional/Slope

Ecology Rating: Category III

City of Sammamish Rating: Category III

Data Plots: 20A-SP1, 20A-SP2

Stations: 352+75 to 355+25

Size: 0.05 acre

---

Wetland 20A is a vegetated ditch located on the east side of the trail in a residential area between the trail and East Lake Sammamish Place SE (see Figure 3-2c). This wetland is located entirely within the project area.

## Hydrology

Wetland hydrology is maintained by groundwater seeps along the slope to the east. Most water in the wetland drains through a pipe at the north end that discharges into Wetland 21B and Unnamed Stream 6. Water in the southern portion of Wetland 20A flows through a small pipe and a ditch to the south, then turns west into another pipe under the trail to Lake Sammamish. Inundation was observed in the ditch and soils were saturated in other portions of the wetland during site visits conducted in November 2007. Soil was saturated in the upper 12 inches during the September 2013 field investigation. This wetland has permanently flooded, seasonally flooded, and saturated only water regimes.

## Vegetation

Wetland 20A is an emergent wetland vegetation community. Dominant vegetation in the wetland is reed canarygrass. English ivy covers much of the south end. Other species include Himalayan blackberry, ladyfern, skunk cabbage, common cattail, American speedwell, English ivy, fringed willowherb, giant horsetail, field horsetail (*Equisetum arvense*), climbing nightshade (*Solanum dulcamara*), purple loosestrife, and birdsfoot trefoil.

## Soils

Soil in Wetland 20A was examined to a depth of 18 inches and consists of two layers. The surface layer is a 6-inch layer of very dark gray (10YR 3/1) silt loam. The subsurface layer is a 12-inch layer of very dark gray (10YR 3/1) gravelly sandy loam. Soil in the area is mapped as Alderwood gravelly sandy loam.

## Buffer

Wetland 20A is located in a residentially developed area; a functional wetland buffer is limited to a slope on the east side of the wetland that extends to the north and south. Vegetation on the slope is dominated by English ivy and Himalayan blackberry. Other species observed include young Oregon ash, beaked hazelnut, salmonberry, Portugal laurel (*Prunus lusitanica*), and black locust (*Robinia pseudoacacia*).

## Wetland Classification

Wetland 20A is classified as a palustrine emergent wetland under the Cowardin et al. (1979) system and depression/slope under the HGM system (Null et al. 2000; Hruby 2004). Wetland 20A is rated a Category III according to the City of Sammamish and Ecology. This wetland scored 45 points on the Washington State Wetland Rating System for Western Washington rating form (18 points for water quality functions, 16 points for hydrologic functions, and 11 points for habitat functions) (see Appendix B). The required buffer width is 50 feet for Category III wetlands scoring less than 20 points for habitat functions in the city of Sammamish (SMC 21A.50.290).

## Wetland Determination

Biologists flagged the boundary of Wetland 20A where indicators of hydrophytic vegetation, hydric soils, and wetland hydrology were present. The wetland edge generally corresponds with a topographic break where one or more of the wetland indicators was lacking.

## Wetland 21AC

Subbasin: Monohon

USFWS Classification: Palustrine Emergent

HGM Classification: Lake-Fringe/Slope

Ecology Rating: Category III

City of Sammamish Rating: Category III

Data Plots: 21A-SP1, 21A-SP2

Stations: 355+50 to 359+25

Size: Approximately 0.40 acre

---

Wetland 21AC<sup>2</sup> is located on the west side of the trail between the trail and Lake Sammamish in a residentially developed area west of the intersection of East Lake Sammamish Place SE, East Lake Sammamish Parkway SE, and SE 16th Street (see Figure 3-2c). Wetland 21AC extends outside the project area to the west, and is associated with Lake Sammamish.

### Hydrology

Wetland hydrology is maintained primarily by groundwater seeps along the slope. Unnamed Stream 6 flows through the wetland in a rock-lined channel in an area that is landscaped. The wetland is sloped and drains toward Lake Sammamish. Occasional inundation occurs and soil saturation at the surface was observed during site visits in October 2007 and March 2014. This wetland has permanently flooded, occasionally flooded, and saturated only water regimes.

### Vegetation

Wetland 21AC is an emergent vegetation community. A majority of the wetland is maintained lawn dominated by unidentified mowed grass, small-fruited bulrush, and creeping buttercup. Other species identified include red-osier dogwood, salmonberry, small-fruited bulrush, common forget-me-not (*Myosotis scorpioides*), and common velvetgrass. An aquatic bed community is present in the lake, outside of the project area.

### Soils

Soil in Wetland 21AC was examined to a depth of 16 inches and consists of three layers. The upper layer is a 4-inch very dark gray (10YR 3/1) sandy loam. The lower layers consist of a 5-inch gray (10YR 5/1) loamy sand with strong brown (7.5YR 4/6) redoximorphic features over a 7-inch dark greenish gray (10Y 4/1) gravelly sand. Soil in the area was mapped as Alderwood gravelly sandy loam.

### Buffer

Wetland 21AC is situated in a residentially developed area with single-family residences and associated yards to the northeast, southeast, and southwest. Lake Sammamish borders the wetland to the northwest. Buffer vegetation consists primarily of ornamental shrubs with beaked hazelnut, swordfern, salmonberry, and maintained lawn dominated by unidentified mowed grass.

### Wetland Classification

Wetland 21AC is classified as a palustrine emergent wetland under the Cowardin et al. (1979) system and lake-fringe/slope under the HGM system (Null et al. 2000; Hruby 2004). Wetland 21AC is rated a

---

<sup>2</sup> Wetland 21AC was identified as two separate wetlands (Wetlands 21A and 21C) during the initial wetland delineations (Parametrix 2005).

Category III according to the City of Sammamish and Ecology. This wetland scored 34 points on the Washington State Wetland Rating System for Western Washington rating form (18 points for water quality functions, 4 point for hydrologic functions, and 12 points for habitat functions) (see Appendix B). The required buffer width is 50 feet for Category III wetlands scoring less than 20 points for habitat functions in the city of Sammamish (SMC 21A.50.290).

### Wetland Determination

Biologists flagged the boundary of Wetland 21AC where indicators of hydrophytic vegetation, hydric soils, and wetland hydrology were present. The wetland edge generally corresponds with a topographic break where one or more of the wetland indicators was lacking.

#### *Wetland 21B*

Subbasin: Monohon

USFWS Classification: Palustrine Forested/Palustrine Scrub-Shrub

HGM Classification: Depressional

Ecology Rating: Category III

City of Sammamish Rating: Category III

Data Plots: 21B-SP1, 21B-SP2

Stations: 355+50 to 356+75

Size: Approximately 0.08 acre

---

Wetland 21B is a depression, located on the east side of the trail in a residentially developed area west of the intersection of East Lake Sammamish Place SE, East Lake Sammamish Parkway SE, and SE 16th Street (see Figure 3-2c). This wetland extends to the east, outside of the project area.

### Hydrology

Wetland hydrology is maintained by local area runoff and Unnamed Stream 6. A culvert at the south end of the wetland passes under a residential driveway and discharges surface water from Wetland 20A. Water flows north through the wetland joining Unnamed Stream 6 and exits through a culvert passing west under the trail into Wetland 21AC. Soil saturation to the surface and inundation was observed in a ditched portion of the wetland during site visits conducted in November 2007 and September 2013. This wetland has permanently flooded, occasionally flooded, and saturated only water regimes.

### Vegetation

Wetland 21B has two vegetation communities: forested and scrub-shrub. The forested community is dominated by red alder and Oregon ash. The scrub-shrub community is dominated by salmonberry, beaked hazelnut, and red-osier dogwood. Other non-dominant species include black twinberry (*Lonicera involucrata*), stink currant (*Ribes bracteosum*), giant horsetail, ladyfern, reed canarygrass, skunk cabbage, climbing nightshade, stinging nettle (*Urtica dioica*), and Himalayan blackberry.

### Soils

Soil in Wetland 21B was examined to a depth of 18 inches and consists of a single layer of black (10YR 2/1) silt loam. Soil in the area is mapped as Alderwood gravelly sandy loam.

### Buffer

The wetland is situated in a residentially developed area. The trail separates the wetland from Wetland 21AC to the northwest. Single-family residences exist to the northeast and southwest. An upland forest area exists to the southeast. Vegetation in the forested buffer includes bigleaf maple, western

Exhibit 16  
SSDP2016-00415

swordfern, beaked hazelnut, cascara buckthorn (*Rhamnus purshiana*), red elderberry (*Sambucus racemosa*), Oregon ash, salmonberry, stinging nettle, and creeping buttercup. The buffer between Wetlands 21B and 21D (to the northeast) comprises Himalayan blackberry, maintained lawn, and landscaped plantings. The vegetated buffer immediately adjacent to the trail consists of mowed grass, reed canarygrass, and Himalayan blackberry.

### Wetland Classification

Wetland 21B is classified as a palustrine forested/palustrine scrub-shrub wetland under the Cowardin et al. (1979) system and depressional under the HGM system (Null et al. 2000; Hruby 2004). Wetland 21B is rated a Category III according to the City of Sammamish and Ecology. This wetland scored 39 points on the Washington State Wetland Rating System for Western Washington rating form (14 points for water quality functions, 10 points for hydrologic functions, and 15 points for habitat functions) (see Appendix B). The required buffer width is 50 feet for Category III wetlands scoring less than 20 points for habitat functions in the city of Sammamish (SMC 21A.50.290).

### Wetland Determination

Biologists flagged the boundary of Wetland 21B where indicators of hydrophytic vegetation, hydric soils, and wetland hydrology were present. The wetland edge generally corresponds with a topographic break where one or more of the wetland indicators was lacking.

#### Wetland 21D

Subbasin: Monohon  
USFWS Classification: Palustrine Emergent  
HGM Classification: Depressional/Slope  
Ecology Rating: Category IV  
City of Sammamish Rating: Category IV  
Data Plots: 21D-SP1 (rev)  
Stations: 357+50 to 359+25  
Size: Approximately 0.15 acre

---

Wetland 21D is a vegetated swale located on the east side of the trail in residential yards west of the intersection of East Lake Sammamish Place SE, East Lake Sammamish Parkway SE, and SE 16th Street (see Figure 3-2c). This wetland extends upslope, outside the project area to the east.

### Hydrology

Wetland hydrology is supported by groundwater discharge, seasonally high groundwater, and local area runoff. Water discharges into the wetland from two drainage sources (pipe and half-pipe) at the north end of the wetland, and seeps from the slope to the east. Water flows south through a swale in the wetland and exits through a culvert at the south end. This pipe appears to join Unnamed Stream 6, which then flows west toward Lake Sammamish through Wetland 21AC. Saturation to the surface and flowing water in the swale was observed during site visits conducted in November 2007 and September 2013. This wetland has permanently flooded and saturated only water regimes.

### Vegetation

Wetland 21D is an emergent vegetation community dominated by maintained lawn with unidentified mowed grass. Other species present include small-fruited bulrush, reed canarygrass, common velvetgrass, common rush, fringed willowherb, Himalayan blackberry, Canada thistle (*Cirsium arvense*), spiny sowthistle (*Sonchus asper*), American speedwell, watercress, and ladyfern.



## Soils

Soil in Wetland 21D was examined to a depth of 14 inches and consists of two layers. The surface layer is a very dark gray (10YR 3/1) silt loam and the subsurface layer is a very dark gray (10YR 3/1) gravelly sandy loam. Soil in the area is mapped as Alderwood gravelly sandy loam.

## Buffer

The wetland is situated in a residential area and surrounded by single-family residences and associated yards. Vegetation consists primarily of maintained lawn and ornamental shrubs. Connectivity to other wetlands is inhibited by development.

## Wetland Classification

Wetland 21D is classified as a palustrine emergent wetland under the Cowardin et al. (1979) system and depressional/slope under the HGM system (Null et al. 2000; Hruby 2004). Wetland 21D is rated a Category IV according to the City of Sammamish and Ecology. This wetland scored 18 points on the Washington State Wetland Rating System for Western Washington rating form (2 points for water quality functions, 6 points for hydrologic functions, and 10 points for habitat functions) (see Appendix B). The required buffer width is 50 feet for Category IV wetlands in the city of Sammamish (SMC 21A.50.290).

## Wetland Determination

Biologists flagged the boundary of Wetland 21D where indicators of hydrophytic vegetation, hydric soils, and wetland hydrology were present. The wetland edge generally corresponds with a topographic break where one or more of the wetland indicators was lacking.

### *Wetland 22AB*

Subbasin: Monohon

USFWS Classification: Palustrine Forested/Palustrine Scrub-Shrub/Palustrine Emergent

HGM Classification: Depressional/Slope

Ecology Rating: Category III

City of Sammamish Rating: Category III

Data Plots: 22AB-SP1, 22AB-SP2

Stations: 361+00 to 367+00

Size: 0.46 acre

---

Wetland 22AB<sup>3</sup> is located on the east side of the trail between the trail and East Lake Sammamish Parkway, northwest of the intersection of East Lake Sammamish Place SE, East Lake Sammamish Parkway SE, and SE 16th Street (see Figures 3-2c and 3-2d). This wetland is located entirely within the project area.

## Hydrology

Wetland hydrology is maintained by seasonally high groundwater, local area runoff, and through flow from an adjacent unnamed stream (Unnamed Stream 7). A culvert passes under East Lake Sammamish Parkway conveying Unnamed Stream 7 adjacent to the north end of Wetland 22AB. Water exits the

---

<sup>3</sup> Wetland 22AB was identified as two separate wetlands (Wetlands 22A and 22B) during the initial wetland delineations (Parametrix 2005).

wetland through culverts under the trail at the south end, center, and north end of the wetland and is piped to Lake Sammamish. Soil saturation at the surface and surface water flowing through the wetland and ditch was observed during site visits conducted in November 2007, May 2008, and September 2013. This wetland has permanently flooded, seasonally flooded, occasionally flooded, and saturated only water regimes.

## Vegetation

Wetland 22AB has three vegetation communities: forested, scrub-shrub, and emergent. Vegetation in the forested community includes red alder, black cottonwood, Pacific willow (*Salix lucida*), red-osier dogwood, salmonberry, Himalayan blackberry, bigleaf maple, and grape (*Vitis* sp.). Vegetation in the scrub-shrub community includes red-osier dogwood, Sitka willow (*Salix sitchensis*), salmonberry, Himalayan blackberry, Pacific willow, English ivy, thimbleberry (*Rubus parviflorus*), and ornamental shrubs. The emergent community in the wetland includes reed canarygrass, hedge false bindweed, ladyfern, giant horsetail, American skunk cabbage, stinging nettle, small-fruited bulrush, and Robert's geranium (*Geranium robertianum*).

## Soils

Two wetland soil pits were examined in Wetland 22AB. The first soil pit (W22AB-SP1) was dug in the forested vegetation community and examined to a depth of 18 inches. The soil pit consists of a single 18-inch layer of black (10YR 2/1) sandy muck. The second soil pit (W22AB-SP2) was dug in scrub-shrub vegetation community and consists of three layers. The upper layer is a 6-inch layer of black (10YR 2/1) mucky loam. The middle layer is a 2-inch layer of black (10YR 2/1) mucky sandy loam. The lower layer is a 10-inch layer of black (2.5Y 2.5/1) mucky loam. Soil in the area is mapped as Alderwood gravelly sandy loam.

## Buffer

Wetland 22AB is situated in a residentially developed area. Single-family residences exist to the north, south, and west of the wetland. A small vegetated upland area to the north provides connectivity to Wetland 22CD. A narrow vegetated buffer exists to the east between the wetland and the East Lake Sammamish Parkway in the northern portion of the wetland. Vegetation within this area includes Sitka spruce (*Picea sitchensis*), black cottonwood, and red alder. No vegetation is located between the wetland and the trail.

## Wetland Classification

Wetland 22AB is classified as a palustrine forested/palustrine scrub-shrub/palustrine emergent wetland under the Cowardin et al. (1979) system and depressional/slope under the HGM system (Null et al. 2000; Hruby 2004). Wetland 22AB is rated a Category III according to the City of Sammamish and Ecology. This wetland scored 46 points on the Washington State Wetland Rating System for Western Washington rating form (20 points for water quality functions, 6 points for hydrologic functions, and 20 points for habitat functions) (see Appendix B). The required buffer width is 75 feet for Category III wetlands scoring between 20 and 28 points for habitat functions in the city of Sammamish (SMC 21A.50.290).

## Wetland Determination

Biologists flagged the boundary of Wetland 22AB where indicators of hydrophytic vegetation, hydric soils, and wetland hydrology were present. The wetland edge generally corresponds with a topographic break where one or more of the wetland indicators was lacking.

## Wetland 22CD

Subbasin: Monohon

USFWS Classification: Palustrine Scrub-Shrub/Palustrine Emergent

HGM Classification: Depressional/Slope

Ecology Rating: Category IV

City of Sammamish Rating: Category IV

Data Plots: 22CD-SP1(rev), 22CD-SP2(rev)

Stations: 368+00 to 370+50

Size: 0.06 acre

---

Wetland 22CD is located on the east side of the trail between the trail and East Lake Sammamish Parkway (see Figure 3-2d). This wetland is located entirely within the project area.

### Hydrology

Wetland hydrology is supported by local area runoff and seasonally high groundwater. The wetland is drained by a ditch running along the toe of the trail prism. Water flows from both the north and the south and drains through a culvert that passes under the trail and flows west to Lake Sammamish. An upland area separates the northern and southern portion of the wetland, but hydrologic connectivity is maintained by a culvert. In October 2013, gravel was observed in the ditch adjacent to the lawn area to the north. Water was not visible in this portion of the ditch due to the gravel depth. Soil was saturated during the November 2007 and October 2013 site visits. Standing water in the southern portion of the ditch was also observed in 2013. This wetland has occasionally flooded and saturated only water regimes.

### Vegetation

Wetland 22CD has two vegetation communities: scrub-shrub and emergent. The scrub-shrub community is in the center of the wetland, dominated by Himalayan blackberry. Emergent communities are located at the north and south ends. The northern emergent community is the largest portion of the wetland, dominated by mowed grass and creeping buttercup. The southern emergent community is dominated by reed canarygrass, small-fruited bulrush, and fowl bluegrass (*Poa palustris*). Other species present include red-osier dogwood, giant horsetail, redtop (*Agrostis gigantea*), common velvetgrass, hedge false bindweed, common rush, and birdsfoot trefoil. Common duckweed was observed in standing water in the ditch.

### Soils

Soil examined in Wetland 22CD consisted of a 16-inch layer of black (10YR 2/1) gravelly sandy loam over a very dark gray (N 3/-) sandy loam. Soil in the area is mapped as Alderwood gravelly sandy loam.

### Buffer

Wetland 22CD is situated in a residentially developed area. The vegetated buffer to the east consists of a lawn with a few trees including Lombardy poplar, Japanese knotweed (*Fallopia japonica*), Himalayan blackberry, western redcedar, red alder, red-osier dogwood, and ornamental plum (*Prunus* sp.). The buffer between the wetland and the trail is composed of a narrow band of maintained herbaceous vegetation. A vegetated area to the south of the wetland provides a corridor to Wetland 22AB. East Lake Sammamish Shore Lane SE is located to the north of Wetland 22CD.

## Wetland Classification

Wetland 22CD is classified as a palustrine scrub-shrub/palustrine emergent wetland under the Cowardin et al. (1979) system and depressional/slope under the HGM system (Null et al. 2000; Hruby 2004). Wetland 22CD is rated a Category IV according to the City of Sammamish and Ecology. This wetland scored 22 points on the Washington State Wetland Rating System for Western Washington rating form (6 points for water quality functions, 7 points for hydrologic functions, and 9 points for habitat functions) (see Appendix B). The required buffer width is 50 feet for Category IV wetlands in the city of Sammamish (SMC 21A.50.290).

## Wetland Determination

Biologists flagged the boundary of Wetland 22CD where indicators of hydrophytic vegetation, hydric soils, and wetland hydrology were present. The wetland edge generally corresponds with a topographic break where one or more of the wetland indicators was lacking.

### *Wetland 22E*

Subbasin: Monohon

USFWS Classification: Palustrine Emergent

HGM Classification: Depressional

Ecology Rating: Category IV

City of Sammamish Rating: Category IV

Data Plot: 22E-SP1

Stations: 365+25 to 365+75

Size: <0.01 acre

---

Wetland 22E is a narrow swale located on the west side of the trail between the trail and East Lake Sammamish Shore Lane SE (see Figures 3-2c and 3-2d). This wetland is located entirely within the project area, within the maintained portion of the corridor.

## Hydrology

Wetland hydrology is supported by local area runoff and seasonally high groundwater with no surface water inlets or outlets. Soil was saturated to the surface during the October 2013 site visit. This wetland has a saturated only water regime.

## Vegetation

Vegetation in Wetland 22E is an emergent community consisting of giant horsetail, reed canarygrass, small-fruited bulrush, creeping buttercup, skunk cabbage, Cooley's hedgenettle (*Stachys chamissonis*), yellow flag (*Iris pseudacorus*), and birdsfoot trefoil.

## Soils

Soil examined in Wetland 22E consisted of a 13-inch layer of very dark brown (10YR 2/2) silt loam over a dark greenish gray (10Y 4/1) gravelly sandy loam. Soil in the area is mapped as Alderwood gravelly sandy loam.

## Buffer

Wetland 22E is situated in a residentially developed area. The vegetated buffer is limited between the trail and East Lake Sammamish Shore Lane SE, consisting of maintained grasses, English ivy, and a row of arborvitae.

## Wetland Classification

Wetland 22E is classified as a palustrine emergent wetland under the Cowardin et al. (1979) system and depressional under the HGM system (Null et al. 2000; Hruby 2004). Wetland 22E is rated a Category IV according to the City of Sammamish and Ecology. This wetland scored 26 points on the Washington State Wetland Rating System for Western Washington rating form (8 points for water quality functions, 9 points for hydrologic functions, and 9 points for habitat functions) (see Appendix B). The required buffer width is 50 feet for Category IV wetlands in the city of Sammamish (SMC 21A.50.290).

## Wetland Determination

Biologists flagged the boundary of Wetland 22E where indicators of hydrophytic vegetation, hydric soils, and wetland hydrology were present. The wetland edge generally corresponds with a topographic break where one or more of the wetland indicators was lacking.

### Wetland 23A

Subbasin: Monohon

USFWS Classification: Palustrine Emergent

HGM Classification: Depressional/Slope

Ecology Rating: Category IV

City of Sammamish Rating: Category IV

Data Plots: 23A-SP1, 23A-SP2

Stations: 373+50 to 374+25

Size: 0.03 acre

---

Wetland 23A is located on the east side of the trail between the trail and East Lake Sammamish Parkway (see Figure 3-2d). This wetland is located entirely within the project area.

## Hydrology

Wetland hydrology is maintained by groundwater seeps from the slope to the east and local area runoff collected in the trailside ditch from the north and south. Standing water was observed in the associated ditch during the September 2013 site visit. This wetland has saturated only and permanently flooded water regimes.

## Vegetation

Wetland 23A contains an emergent vegetation community. Dominant vegetation includes reed canarygrass and giant horsetail. Other species observed include small-fruited bulrush, red fescue, common scouring rush (*Equisetum hyemale*), common ladyfern, bentgrass (*Agrostis* sp.), common cattail, common velvetgrass, common rush, fringed willowherb, black twinberry, and cluster rose (*Rosa pisocarpa*). American speedwell and common duckweed were present in the ditch.

## Soils

Soil examined in Wetland 23A consisted of a 10-inch layer of very black (10YR 2/1) gravelly sandy loam over a very dark gray (2.5Y 3/1) gravelly sandy loam with dark yellowish brown (10YR 4/6) redoximorphic features. Soil in the area is mapped as Alderwood gravelly sandy loam.

## Buffer

Wetland buffer consists of a narrow strip between the trail and East Lake Sammamish Parkway. Vegetation in the buffer includes bigleaf maple, English ivy, bracken fern, giant horsetail, common scouring rush, salal, cluster rose, Himalayan blackberry, western swordfern, and red alder. The trail and

a very narrow band of maintained reed canarygrass is located to the west of the wetland. A forested area to the north of the wetland provides a vegetated corridor to Wetland 23C.

## Wetland Classification

Wetland 23A is classified as a palustrine emergent wetland under the Cowardin et al. (1979) system and depressional/slope under the HGM system (Null et al. 2000; Hruby 2004). Wetland 23A is rated a Category IV according to the City of Sammamish and Ecology. This wetland scored 27 points on the Washington State Wetland Rating System for Western Washington rating form (14 points for water quality functions, 7 points for hydrologic functions, and 7 points for habitat functions) (see Appendix B). The required buffer width is 50 feet for Category IV wetlands in the city of Sammamish (SMC 21A.50.290).

## Wetland Determination

Biologists flagged the boundary of Wetland 23A where indicators of hydrophytic vegetation, hydric soils, and wetland hydrology were present. The wetland edge generally corresponds with a topographic break where one or more of the wetland indicators was lacking.

### *Wetland 23B*

Subbasin: Monohon

USFWS Classification: Palustrine Scrub-Shrub/Palustrine Emergent

HGM Classification: Lake-Fringe/Slope

Ecology Rating: Category III

City of Sammamish Rating: Category III

Data Plots: 23B-SP1, 23B-SP2

Stations: 374+00 to 374+75

Size: Approximately 0.05 acre

---

Wetland 23B is located on the west side of the trail between the trail and Lake Sammamish (see Figure 3-2d). Wetland 23B extends outside the project area to the west, and is associated with Lake Sammamish.

## Hydrology

Wetland hydrology is supported by Lake Sammamish, seasonally high groundwater, and groundwater seeps. Soil saturation in the upper 12 inches was observed during site visits conducted in October 2007. The wetland is sloped and drains to Lake Sammamish. This wetland has a saturated only water regime.

## Vegetation

Wetland 23B has scrub-shrub and emergent wetland communities. The scrub-shrub community is dominated by red-osier dogwood, Himalayan blackberry, common scouring rush, and yellow flag. Dominant vegetation in the emergent area includes common ladyfern, small-fruited bulrush, field horsetail, and birdsfoot trefoil.

## Soils

Soil in Wetland 23B was examined to a depth of 16 inches and consists of two layers. The upper layer is a 10-inch layer of black (10YR 2/1) mucky loam. The lower layer is a dark reddish gray (2.5YR 4/1) gravelly sand. Soil in the area is mapped as Alderwood gravelly sandy loam.

## Buffer

Wetland 23B is situated in a residentially developed area. Single-family residences exist to the north and the south. Lake Sammamish borders the wetland to the west. The wetland is separated from Wetland 23A to the east by the trail. Vegetation in the surrounding buffer area is dominated by Himalayan blackberry, trailing blackberry (*Rubus ursinus*), and hedge false bindweed, with black cottonwood, western redcedar, giant horsetail, common scouring rush, bracken fern, and western swordfern.

## Wetland Classification

Wetland 23B is classified as a palustrine scrub-shrub/palustrine emergent wetland under the Cowardin et al. (1979) system and lake-fringe/slope under the HGM system (Null et al. 2000; Hruby 2004). Wetland 23B is rated a Category III according to the City of Sammamish and Ecology. This wetland scored 34 points on the Washington State Wetland Rating System for Western Washington rating form (20 points for water quality functions, 4 points for hydrologic functions, and 10 points for habitat functions) (see Appendix B). The required buffer width is 50 feet for Category III wetlands scoring less than 20 points for habitat functions in the city of Sammamish (SMC 21A.50.290).

## Wetland Determination

Biologists flagged the boundary of Wetland 23B where indicators of hydrophytic vegetation, hydric soils, and wetland hydrology were present. The wetland edge generally corresponds with a topographic break where one or more of the wetland indicators was lacking.

### *Wetland 23C*

Subbasin: Pine Lake

USFWS Classification: Palustrine Scrub-Shrub/Palustrine Emergent

HGM Classification: Depressional

Ecology Rating: Category III

City of Sammamish Rating: Category III

Data Plots: 23C-SP1, 23C-SP2

Stations: 377+25 to 378+50

Size: 0.09 acre

---

Wetland 23C is located on the east side of the trail between the trail and East Lake Sammamish Parkway, south of Pine Lake Creek, and approximately 600 feet southeast of SE 8th Street (see Figure 3-2d). This wetland is located entirely within the project area.

## Hydrology

Wetland hydrology is supported by seasonally high groundwater and local area runoff. Saturation was observed during site visits conducted in November 2007. Although no inundation was observed during the site visit, soils were saturated in the upper 12 inches. The wetland drains to the trailside ditch to the south that is connected downgradient to Wetland 23A. This wetland has permanently flooded (in ditch), occasionally flooded, and saturated only water regimes.

## Vegetation

Wetland 23C has two vegetation communities: scrub-shrub and emergent. The scrub-shrub community is dominated by Himalayan blackberry and salmonberry with other species including Pacific willow, Sitka willow, black twinberry, common ladyfern, giant horsetail, and red elderberry. Some reed canarygrass is growing in this community. The emergent community is dominated by reed canarygrass, ladyfern, and creeping buttercup. Other species include giant horsetail and common duckweed (in ditch).

**Exhibit 16**  
**SSDP2016-00415**

## Soils

Soil in Wetland 23C was examined to a depth of 18 inches and consists of two layers. The upper layer is an 11-inch layer of black (10YR 2/1) loam. The lower layer is a dark gray (5Y 4/1) loamy clay with strong brown (7.5YR 4/6) redoximorphic features. Soil in the area is mapped as Alderwood gravelly sandy loam.

## Buffer

Single-family residences and the trail exist to the west of the wetland. Vegetated areas to the north and east of the wetland are dominated by Himalayan blackberry and disturbed vegetation with few trees; connections to other habitats are disrupted by roads and driveways. A vegetated corridor to the south of the wetland provides connectivity to Wetland 23A. Vegetation in the buffer to the south includes ornamental plum, Himalayan blackberry, bracken fern, and reed canarygrass.

## Wetland Classification

Wetland 23C is classified as a palustrine scrub-shrub/palustrine emergent wetland under the Cowardin et al. (1979) system and depressional under the HGM system (Null et al. 2000; Hruby 2004). Wetland 23C is rated a Category III according to the City of Sammamish and Ecology. This wetland scored 38 points on the Washington State Wetland Rating System for Western Washington rating form (10 points for water quality functions, 14 points for hydrologic functions, and 14 points for habitat functions) (see Appendix B). The required buffer width is 50 feet for Category III wetlands scoring less than 20 points for habitat functions in the city of Sammamish (SMC 21A. 50. 290).

## Wetland Determination

Biologists flagged the boundary of Wetland 23C where indicators of hydrophytic vegetation, hydric soils, and wetland hydrology were present. The wetland edge generally corresponds with a topographic break where one or more of the wetland indicators was lacking.

### *Wetland 24A*

Subbasin: Pine Lake

USFWS Classification: Palustrine Forested/Palustrine Scrub-Shrub/Palustrine Emergent

HGM Classification: Depressional/Riverine

Ecology Rating: Category III

City of Sammamish Rating: Category III

Data Plots: 24A-SP1

Stations: 379+25 to 385+25

Size: 0.60 acre

Wetland 24A is located on the east side of the trail between the trail and East Lake Sammamish Parkway west of the intersection of East Lake Sammamish Parkway and SE 8th Street (see Figure 3-2d). This wetland is located entirely within the project area.

## Hydrology

Wetland hydrology is supported by seasonally high groundwater, local area runoff, and overbank flow of Unnamed Stream 8 and Pine Lake Creek. Pine Lake Creek drains into the southern end of Wetland 24A and Unnamed Stream 8 drains into the northern end. Pine Lake Creek continues west through Wetland 24A through a culvert under the trail to Wetland 24B. Historically, Unnamed Stream 8 flowed west through Wetland 24A to Wetland 24B via a pipe under the trail. However, the channel of Unnamed Stream 8 has been altered and flows travel both west (as South Fork Unnamed Stream 8, to Wetland 24B) and north (as North Fork Unnamed Stream 8) to Wetland 24C via a pipe under a driveway. A ditch

Exhibit 16  
SSDP2016-00415

000755<sub>3-41</sub>



runs along the west side of the wetland, parallel to the trail. Surface water occurs in this ditch between Pine Lake Creek and Unnamed Stream 8. This wetland has occasionally flooded and saturated only water regimes. The ditch has permanent standing water. Soils were saturated during the wetland delineation and standing water was observed in the ditch during the September 2013 site visit.

## Vegetation

Wetland 24A has three vegetation communities: forested, scrub-shrub, and emergent. The forested community is dominated by red alder with an understory of salmonberry and giant horsetail. Other species include reed canarygrass, black twinberry, Pacific willow, cluster rose, and common ladyfern. The scrub-shrub community consists of red-osier dogwood, Himalayan blackberry, salmonberry, black twinberry, reed canarygrass, cluster rose, and giant horsetail. The emergent vegetation, primarily located in the ditch adjacent to the trail, includes reed canarygrass, common ladyfern, giant horsetail, yellow flag, small-fruited bulrush, common rush, Cooley's hedgenettle, and large-leaf avens (*Geum macrophyllum*).

## Soils

Soil in Wetland 24A was examined to a depth of 18 inches and consists of two layers. The upper layer consists of a 12-inch layer of black (10YR 2/1) silt loam. The lower layer is a very dark gray (10YR 3/1) sandy loam. Soil in the area is mapped as Seattle muck.

## Buffer

A narrow band of maintained herbaceous vegetation is located between the wetland and East Lake Sammamish Parkway. Wetland 24B is located to the west of the wetland, but the connection is disrupted by the trail. Driveways separate Wetland 24A from Wetland 23C to the south and Wetland 24C to the north. A very narrow strip of maintained herbaceous vegetation is located between the wetland and the trail.

## Wetland Classification

Wetland 24A is classified as a palustrine forested/palustrine scrub-shrub wetland under the Cowardin et al. (1979) system and depressional/riverine under the HGM system (Null et al. 2000; Hruby 2004). Wetland 24A is rated a Category III according to the City of Sammamish and Ecology. This wetland scored 42 points on the Washington State Wetland Rating System for Western Washington rating form (12 points for water quality functions, 12 points for hydrologic functions, and 18 points for habitat functions) (see Appendix B). The required buffer width is 50 feet for Category III wetlands scoring less than 20 points for habitat functions in the city of Sammamish (SMC 21A.50.290).

## Wetland Determination

Biologists flagged the boundary of Wetland 24A where indicators of hydrophytic vegetation, hydric soils, and wetland hydrology were present. The wetland edge generally corresponds with a topographic break where one or more of the wetland indicators was lacking.

## Wetland 24B

Subbasin: Pine Lake

USFWS Classification: Palustrine Forested/Palustrine Scrub-Shrub

HGM Classification: Depressional/Riverine

Ecology Rating: Category III

City of Sammamish Rating: Category III

Data Plots: 24B-SP1, 24B-SP2

Stations: 379+25 to 384+75

Size: Approximately 1.75 acres

---

Wetland 24B is located on the west side of the trail in a residential area west of the intersection of East Lake Sammamish Parkway and SE 8th Street (see Figure 3-2d). Wetland 24B extends outside the project area to the west.

### Hydrology

Wetland hydrology is maintained by seasonally high groundwater, overbank flow of Pine Lake Creek, South Fork Unnamed Stream 8, and surface water from Wetland 24A. Pine Lake Creek drains from Wetland 24A to the southern end of Wetland 24B via a culvert under the trail. South Fork Unnamed Stream 8 flows west from Wetland 24A to the northern end of Wetland 24B via a culvert under the trail. Inundation was observed in the wetland during site visits conducted in November 2007. This wetland has permanently flooded, occasionally flooded, and saturated only water regimes. Surface water was observed on adjacent property at the southwest corner (near Pine Lake Creek) and at the north end associated with the South Fork Unnamed Stream 8 during the September 2016 site visit.

### Vegetation

Wetland 24B is a forested and shrub wetland. Forested vegetation in the wetland includes weeping willow, Pacific willow, red alder, and black cottonwood, with a shrub understory consisting of salmonberry, red-osier dogwood, and Himalayan blackberry. Some areas lack an overstory and are dominated by salmonberry, red-osier dogwood, and Himalayan blackberry. Non-dominant understory species include black twinberry, Sitka willow, Scouler's willow (*Salix scouleriana*), western swordfern, reed canarygrass, giant horsetail, common ladyfern, and hedge false bindweed.

### Soils

Soil in Wetland 24B was examined and consists of a single 16-inch layer of black (10YR 2/1) silt loam. Soil in the area is mapped as Kitsap silt loam.

### Buffer

Wetland 24B is situated in a residential area with single-family residences and maintained yards to the north, west, and south. Wetland 24A exists to the east, but connectivity is disrupted by the trail. Buffer is limited to a narrow band of vegetation around the wetland. Buffer vegetation includes Pacific ninebark (*Physocarpus capitatus*), Himalayan blackberry, reed canarygrass, thimbleberry, red alder, black cottonwood, and giant horsetail. The buffer between the trail and the wetland is dominated by maintained herbaceous vegetation, reed canarygrass, and hedge false bindweed.

### Wetland Classification

Wetland 24B is classified as a palustrine forested/palustrine scrub-shrub wetland under the Cowardin et al. (1979) system and depressional/riverine under the HGM system (Null et al. 2000; Hruby 2004). Wetland 24B is rated a Category III according to the City of Sammamish and Ecology. This wetland

Exhibit 16  
SSDP2016-00415

000757 3-43

scored 43 points on the Washington State Wetland Rating System for Western Washington rating form (12 points for water quality functions, 12 points for hydrologic functions, and 19 points for habitat functions) (see Appendix B). The required buffer width is 50 feet for Category III wetlands scoring less than 20 points for habitat functions in the city of Sammamish (SMC 21A.50.290).

## Wetland Determination

Biologists flagged the boundary of Wetland 24B where indicators of hydrophytic vegetation, hydric soils, and wetland hydrology were present. The wetland edge generally corresponds with a topographic break where one or more of the wetland indicators was lacking. Wetland 24B extends west outside of the study area.

### *Wetland 24C*

Subbasin: Pine Lake

USFWS Classification: Palustrine Forested /Palustrine Emergent

HGM Classification: Depressional/Riverine

Ecology Rating: Category III

City of Sammamish Rating: Category III

Data Plots: 24C-SP1, 24C-SP2

Stations: 385+50 to 390+25

Size: 0.16 acre

---

Wetland 24C is located on the east side of the trail between the trail and East Lake Sammamish Parkway northwest of the intersection of East Lake Sammamish Parkway and SE 8th Street (see Figure 3-2d). This wetland is located entirely within the project area.

## Hydrology

Wetland hydrology is maintained by local area runoff and by overbank flow of North Fork Unnamed Stream 8. This stream enters the wetland from a culvert that discharges at the southeast corner from Wetland 24A. The stream flows northwest and exits through a culvert that passes under the trail and continues west, likely piped to Lake Sammamish. Soils were saturated during the wetland delineation. This wetland has a seasonally flooded water and saturated only regime.

## Vegetation

Wetland 24C has two vegetation communities: forested and emergent. The forested community is dominated by red alder, Himalayan blackberry, black twinberry, Pacific ninebark, Sitka willow, and Pacific willow. Herbaceous vegetation in the understory includes small-fruited bulrush, slough sedge, hedge false bindweed, common ladyfern, giant horsetail, fringed willowherb, and skunk cabbage. An emergent community makes up the narrow portion along the ditch to the north, dominated by reed canarygrass with some small-fruited bulrush and American speedwell.

## Soils

Soil in Wetland 24C was examined to a depth of 18 inches and consists of four layers. The upper and first layer is a 6-inch layer of black (10YR 2/1) loam. The second layer is a 4-inch layer of a very dark gray (10YR 3/1) gravelly sandy loam. The third layer is a 6-inch layer of dark grayish brown (10YR 4/2) gravelly sandy loam. The lowest layer is a gray (10YR 5/1) silt with yellowish brown (10YR 5/6) redoximorphic features. Soil in the area is mapped as Seattle muck.

## Buffer

Wetland 24C is situated in a residentially developed area. Single-family residential homes are to the west and East Lake Sammamish Parkway to the east. Wetland 24A is south of the wetland, but connectivity is disrupted by a residential driveway. A vegetated upland area occurs north of the wetland between the trail and East Lake Sammamish Parkway. Vegetation in the buffer consists primarily of Himalayan blackberry, red alder, black cottonwood, reed canarygrass, and giant horsetail with some conifers to the north.

## Wetland Classification

Wetland 24C is classified as a palustrine forested/palustrine emergent wetland under the Cowardin et al. (1979) system and depressional/riverine under the HGM system (Null et al. 2000; Hruby 2004). Wetland 24C is rated a Category III according to the City of Sammamish and Ecology. This wetland scored 34 points on the Washington State Wetland Rating System for Western Washington rating form (10 points for water quality functions, 10 points for hydrologic functions, and 14 points for habitat functions) (see Appendix B). The required buffer width is 50 feet for Category III wetlands scoring less than 20 points for habitat functions in the city of Sammamish (SMC 21A.50.290).

## Wetland Determination

Biologists flagged the boundary of Wetland 24C where indicators of hydrophytic vegetation, hydric soils, and wetland hydrology were present. The wetland edge generally corresponds with a topographic break where one or more of the wetland indicators was lacking.

### *Wetland 25A*

Subbasin: Monohon

USFWS Classification: Palustrine Forested

HGM Classification: Depressional/Riverine

Ecology Rating: Category III

City of Sammamish Rating: Category III

Data Plots: 25A-SP1, 25A-SP2

Stations: 400+00 to 403+00

Size: 0.25 acre

---

Wetland 25A is located on the east side of the trail between the trail and East Lake Sammamish Parkway (see Figure 3-2e). This wetland is located entirely within the project area.

## Hydrology

Wetland hydrology is maintained by local area runoff, overbank flow of Stream 0155, and surface water from Wetland 25B. The tributary enters the wetland at the northeast corner through a culvert that flows under East Lake Sammamish Parkway. The tributary flows southwest through the wetland and exits to a culvert in the center of the wetland's west boundary. The culvert is piped west to Lake Sammamish. Wetland 25A also receives surface water from Wetland 25B to the north through a pipe under a residential driveway near East Lake Sammamish Parkway. A maintained ditch from the south may also contribute seasonal surface water. Inundation was observed through most of the wetland during field visits conducted in November 2007 and September 2013. This wetland has permanently flooded and seasonally flooded water regimes.

## Vegetation

Wetland 25A has a forested vegetation community dominated by Pacific willow with red-osier dogwood, black twinberry, Sitka willow, reed canarygrass, Himalayan blackberry, slough sedge, small-fruited bulrush, cluster rose, and yellow flag. Duckweed is present in small pockets of standing water.

## Soils

Soil in Wetland 25A was examined to a depth of 18 inches and consists of two layers. The upper layer is an 8-inch layer of very dark gray (10YR 3/1) silt loam. The lower layer is a black (10YR 2/1) loam. Soil in the areas is mapped as Norma sandy loam.

## Buffer

Wetland 25A is situated in a residentially developed area. Single-family residences and the trail are to the west of the wetland and East Lake Sammamish Parkway is to the east. Beyond the parkway is a large wetland labeled as East Lake Sammamish #64 under King County's wetland inventory. Driveways disrupt connectivity between Wetland 25A and Wetland 25B to the north and a forested area to the south. Buffer is limited to small patches at the north and south end of the wetland and a narrow band running along the shoulder of the parkway. Buffer vegetation includes Himalayan blackberry, hedge false bindweed, reed canarygrass, and lawn with landscaped trees and shrubs.

## Wetland Classification

Wetland 25A is classified as a palustrine forested wetland under the Cowardin et al. (1979) system and depressional/riverine under the HGM system (Null et al. 2000; Hruby 2004). Wetland 25A is rated a Category III according to the City of Sammamish and Ecology. This wetland scored 46 points on the Washington State Wetland Rating System for Western Washington rating form (20 points for water quality functions, 12 points for hydrologic functions, and 14 points for habitat functions) (see Appendix B). The required buffer width is 50 feet for Category III wetlands scoring less than 20 points for habitat functions in the city of Sammamish (SMC 21A.50.290).

## Wetland Determination

Biologists flagged the boundary of Wetland 25A where indicators of hydrophytic vegetation, hydric soils, and wetland hydrology were present. The wetland edge generally corresponds with a topographic break where one or more of the wetland indicators was lacking.

### *Wetland 25B*

Subbasin: Monohon

USFWS Classification: Palustrine Forested/Palustrine Scrub-Shrub/Palustrine Emergent

HGM Classification: Depressional

Ecology Rating: Category III

City of Sammamish Rating: Category III

Data Plots: 25B-SP1, 25B-SP2, 25B-SP3

Stations: 403+50 to 407+75

Size: 0.33 acre

Wetland 25B is located on the east side of the trail between the trail and East Lake Sammamish Parkway (see Figure 3-2e). This wetland is located entirely within the project area.

## Hydrology

Wetland hydrology is maintained by seasonally high groundwater and local area runoff. Soils were saturated during the wetland delineation. A swale runs north and south along the east side of the trail and drains the wetland through a culvert at the south end of the swale, which passes under a residential driveway and discharges into Wetland 25A. This wetland has seasonally flooded, occasionally flooded, and saturated only water regimes.

## Vegetation

Wetland 25B has three vegetation communities: forested, scrub-shrub, and emergent. The forested community is dominated by Oregon ash with an understory of Himalayan blackberry and red-osier dogwood. The shrub community consists of black twinberry, rose, red-osier dogwood, Himalayan blackberry, Sitka willow, Douglas spirea (*Spiraea douglasii*), reed canarygrass, and Pacific willow. The emergent community consists of reed canarygrass, slough sedge, hedge false bindweed, giant horsetail, creeping buttercup, and field horsetail.

## Soils

Two wetland soil pits were examined in Wetland 25B. The first soil pit (25B-SP1) was dug in an emergent vegetation community. Soil pit 25B-SP1 was examined to a depth of 17 inches and consists of two layers. The upper layer is a 6-inch layer of very dark grayish brown (10YR 3/2) gravelly silt loam. The lower layer is a very dark gray (10YR 3/1) silt loam with dark brown (10YR 3/3) redoximorphic features. The second soil pit (25B-SP3) was dug in a forested vegetation community. Soil pit 25B-SP3 was examined to a depth of 20 inches and consists of three layers. The upper layer is a 7-inch layer of black (10YR 2/1) loam. The middle layer is a 10-inch layer of dark gray (2.5Y 4/1) clay loam with strong brown (7.5YR 4/6) redoximorphic features. The lower layer is a gray (10YR 5/1) clay loam with strong brown redoximorphic features. Soil in the area is mapped as Norma sandy loam.

## Buffer

Wetland 25B is situated in a residentially developed area. Single-family residences and the trail are to the west of the wetland and East Lake Sammamish Parkway is to the east. Beyond the parkway is a large wetland labeled as East Lake Sammamish #64 under King County's wetland inventory. Driveways disrupt connectivity between Wetland 25B and Wetland 25A to the south and Wetland 25C to the north. Vegetated buffer is limited to small patches of Himalayan blackberry and reed canarygrass at the south end of the wetland. Vegetation includes Himalayan blackberry, reed canarygrass, creeping buttercup, hedge false bindweed, Robert's geranium, stickywilly (*Galium aparine*), and curly dock (*Rumex crispus*). The buffer between the wetland and trail consists of maintained reed canarygrass, creeping buttercup, and Himalayan blackberry.

## Wetland Classification

Wetland 25B is classified as a palustrine forested/palustrine scrub-shrub/palustrine emergent wetland under the Cowardin et al. (1979) system and depressional under the HGM system (Null et al. 2000; Hruby 2004). Wetland 25B is rated a Category III according to the City of Sammamish and Ecology. This wetland scored 48 points on the Washington State Wetland Rating System for Western Washington rating form (18 points for water quality functions, 10 points for hydrologic functions, and 18 points for habitat functions) (see Appendix B). The required buffer width is 50 feet for Category III wetlands scoring less than 20 points for habitat functions in the city of Sammamish (SMC 21A.50.290).

## Wetland Determination

Biologists flagged the boundary of Wetland 25B where indicators of hydrophytic vegetation, hydric soils, and wetland hydrology were present. The wetland edge generally corresponds with a topographic break where one or more of the wetland indicators was lacking.

### Wetland 25C

Subbasin: Thompson

USFWS Classification: Palustrine Forested/Palustrine Emergent

HGM Classification: Depressional

Ecology Rating: Category III

City of Sammamish Rating: Category III

Data Plots: 10C-SP1

Stations: 408+50 to 411+00

Size: 0.25 acre

---

Wetland 25C is located on the east side of the trail between the trail and East Lake Sammamish Parkway (see Figure 3-2e). This wetland is located entirely within the project area.

### Hydrology

Wetland hydrology is supported by seasonally high groundwater and local area runoff. Soils were saturated during the wetland delineation. A ditch runs north and south along the east side of the wetland. A culvert located at the north end of the ditch passes under a driveway and discharges into Wetland 25F and Ebright Creek. This wetland has seasonally flooded and saturated only water regimes.

### Vegetation

Wetland 25C has two vegetation communities: forested and emergent. The forested community is dominated by red alder and Scouler's willow. The understory is vegetated with Himalayan blackberry, snowberry (*Symphoricarpos albus*), red-osier dogwood, rose, black twinberry, and bracken fern. The emergent community is dominated by reed canarygrass.

### Soils

Soil in Wetland 25C was examined to a depth of 18 inches and consists of two layers. The upper layer is a 10-inch layer of disturbed soil that is very dark gray (10YR 3/1) and grayish brown (10YR 5/2) loam with yellowish brown (10YR 5/6) redoximorphic features. The lower layer is a very dark gray (10YR 3/1) silt loam. Soil in the area is mapped as mixed alluvial land.

### Buffer

Wetland 25C is situated in a residentially developed area. Single-family residences and the trail are to the west of the wetland and East Lake Sammamish Parkway is to the east. Beyond the parkway is a large wetland labeled as East Lake Sammamish #64 under King County's wetland inventory. Driveways disrupt connectivity between Wetland 25C and Wetland 25B to the south and Wetland 25F to the north. Buffer around Wetland 25C is limited to the roadside shoulder of East Lake Sammamish Parkway and the maintained edges of the driveway and trail. Vegetation in the buffer consists primarily of reed canarygrass.

### Wetland Classification

Wetland 25C is classified as a palustrine forested/palustrine emergent wetland under the Cowardin et al. (1979) system and depressional under the HGM system (Null et al. 2000; Hruby 2004). Wetland 25C is

Exhibit 16  
SSDP2016-00415

rated a Category III according to the City of Sammamish and Ecology. This wetland scored 42 points on the Washington State Wetland Rating System for Western Washington rating form (14 points for water quality functions, 14 points for hydrologic functions, and 14 points for habitat functions) (see Appendix B). The required buffer width is 50 feet for Category III wetlands scoring less than 20 points for habitat functions in the city of Sammamish (SMC 21A.50.290).

## Wetland Determination

Biologists flagged the boundary of Wetland 25C where indicators of hydrophytic vegetation, hydric soils, and wetland hydrology were present. The wetland edge generally corresponds with a topographic break where one or more of the wetland indicators was lacking.

### *Wetland 25F*

Subbasin: Thompson

USFWS Classification: Palustrine Forested

HGM Classification: Depressional

Ecology Rating: Category III

City of Sammamish Rating: Category III

Data Plots: 25F-SP1

Stations: 411+25 to 412+00

Size: 0.06 acre

---

Wetland 25F is located on the east side of the trail, immediately south of Ebright Creek, and between the trail and East Lake Sammamish Parkway (see Figure 3-2e). This wetland is located entirely within the project area.

## Hydrology

Wetland hydrology is maintained by seasonally high groundwater and local area runoff. The wetland drains into Ebright Creek. Surface water from Wetland 25C passes under a driveway to the south and flows north along the east side of the wetland in a ditch and discharges into Ebright Creek. This wetland has occasionally flooded and saturated only water regimes.

## Vegetation

Wetland 25F has a forested vegetation community. Vegetation includes red alder, Sitka willow, and Pacific willow. Understory vegetation is dominated by red-osier dogwood with Himalayan blackberry, hedge false bindweed, reed canarygrass, creeping buttercup, ladyfern, western swordfern, and English holly (*Ilex aquifolium*).

## Soils

Soil in Wetland 25F was examined to a depth of 18 inches and consists of two layers. The upper layer is a 10-inch layer of black (10YR 2/1) silt loam. The lower layer is a dark gray (10YR 4/1) sandy loam with (7.5Y 4/6) redoximorphic features. Soil in the area is mapped as mixed alluvial land.

## Buffer

Wetland 25F is situated in a residentially developed area. Single-family residences and the trail are to the west of the wetland and East Lake Sammamish Parkway is to the east. Beyond the parkway is a large wetland. Driveways disrupt connectivity between Wetland 25F and Wetland 25C to the south. Wetland 25D is located to the southwest, but connectivity is disrupted by a residential driveway and the trail. Buffer around Wetland 25C is limited to a small area to the north of the wetland. Vegetation in this area

Exhibit 16  
SSDP2016-00415

000763<sub>3-49</sub>



is dominated by Himalayan blackberry and Sitka willow with one corkscrew willow, one western redcedar, and one ornamental plum. Lawn covers the area closest to the driveway. The buffer between the trail and the wetland is primarily composed of mowed reed canarygrass, creeping buttercup, and Himalayan blackberry.

### Wetland Classification

Wetland 25F is classified as a palustrine forested wetland under the Cowardin et al. (1979) system and depressional under the HGM system (Null et al. 2000; Hruby 2004). Wetland 25F is rated a Category III according to the City of Sammamish and Ecology. This wetland scored 30 points on the Washington State Wetland Rating System for Western Washington rating form (12 points for water quality functions, 6 points for hydrologic functions, and 12 points for habitat functions) (see Appendix B). The required buffer width is 50 feet for Category III wetlands with habitat points less than 20 in the city of Sammamish (SMC 21A.50.290).

### Wetland Determination

Biologists flagged the boundary of Wetland 25F where indicators of hydrophytic vegetation, hydric soils, and wetland hydrology were present. The wetland edge generally corresponds with a topographic break where one or more of the wetland indicators was lacking.

#### *Wetland 26A*

Subbasin: Monohon

USFWS Classification: Palustrine Forested/Palustrine Scrub-Shrub/Palustrine Emergent

HGM Classification: Depressional/Riverine

Ecology Rating: Category III

City of Sammamish Rating: Category III

Data Plots: 26A-SP1, 26A-SP2, 26A-SP3

Stations: 421+25 to 431+50

Size: 0.91 acre

---

Wetland 26A is located on the west side of the trail between the trail and East Lake Sammamish Parkway, south of the intersection of East Lake Sammamish Parkway and Louis Thompson Road (see Figures 3-2e and 3-2f). This wetland is located entirely within the project area.

### Hydrology

Wetland hydrology is maintained by seasonally high groundwater and local area runoff. Zackuse Creek flows through the wetland from a culvert that passes under East Lake Sammamish Parkway. The stream flows west through the wetland before entering a culvert and passes under the trail, then to another culvert under a roadway, eventually to Lake Sammamish. Inundation was observed at the north end of the wetland during site visits conducted in November 2007 and small areas of ponding were observed in September 2013. This wetland has seasonally flooded, occasionally flooded, and saturated only water regimes.

### Vegetation

Wetland 26A has three vegetation communities: forested, scrub-shrub, and emergent. The forested community is dominated by Pacific willow, red alder, and red-osier dogwood with cascara and Sitka willow. The scrub-shrub community is dominated by red-osier dogwood, black twinberry, Douglas spirea, Himalayan blackberry, cluster rose, salmonberry, Sitka willow, and red alder. One paper birch (*Betula papyrifera*) is also growing in this community. The emergent community is dominated by reed

Exhibit 16

SSDP2016-00415

000764

canarygrass. Other species in the emergent area include giant horsetail, ladyfern, small-fruited bulrush, common rush, hedge false bindweed, and ornamental bamboo.

## Soils

Soil in Wetland 26A (26A-SP1) was examined to a depth of 16 inches and consists of one layer. It is black (10YR 2/1) silt with no redoximorphic features. Soil in the area is mapped as Alderwood and Kitsap soils and mixed alluvial land.

## Buffer

Wetland 26A is situated between the trail and East Lake Sammamish Parkway. Buffer is minimal to the east and west. West of the wetland between the trail and Lake Sammamish are single-family residences. A large forested wetland is located to the east of the wetland, but connectivity is disrupted by the parkway. A vegetated buffer exists to the north of the wetland. A small patch of upland buffer also exists at the south end of the wetland that includes a row of western redcedar. Vegetation in the buffer is primarily Himalayan blackberry and reed canarygrass with bigleaf maple and some Douglas fir to the north. The buffer between the trail and the wetland consists primarily of maintained herbaceous vegetation, reed canarygrass, and hedge false bindweed.

## Wetland Classification

Wetland 26A is classified as a palustrine forested/palustrine scrub-shrub/palustrine emergent wetland under the Cowardin et al. (1979) system and depressional/riverine under the HGM system (Null et al. 2000; Hruby 2004). Wetland 26A is rated a Category III according to the City of Sammamish and Ecology. This wetland scored 47 points on the Washington State Wetland Rating System for Western Washington rating form (16 points for water quality functions, 12 points for hydrologic functions, and 19 points for habitat functions) (see Appendix B). The required buffer width is 50 feet for Category III wetlands scoring less than 20 points for habitat functions in the city of Sammamish (SMC 21A.50.290).

## Wetland Determination

Biologists flagged the boundary of Wetland 26A where indicators of hydrophytic vegetation, hydric soils, and wetland hydrology were present. The wetland edge generally corresponds with a topographic break where one or more of the wetland indicators was lacking.

### *Wetland 26B*

Subbasin: Monohon

USFWS Classification: Palustrine Emergent

HGM Classification: Slope

Ecology Rating: Category IV

City of Sammamish Rating: Category IV

Data Plots: 26B-SP1, 26B-SP2

Stations: 425+25 to 425+50

Size: 0.02 acre

Wetland 26B is located on the west side of the trail north of Zackuse Creek and approximately 800 feet south of the intersection of East Lake Sammamish Parkway and Louis Thompson Road (see Figure 3-2f). This wetland is located entirely within the project area.

## Hydrology

Wetland hydrology is maintained by seasonally high groundwater. No inlet or outlet exists. Soil saturation in the upper 12 inches was observed during site visits conducted in November 2007 and March 2014. This wetland has a saturated only water regime.

## Vegetation

Wetland 26B is an emergent vegetation community. The area is maintained lawn including white clover (*Trifolium repens*), creeping bentgrass (*Agrostis stolonifera*), bluegrass (*Poa asp.*), common velvetgrass, common dandelion (*Taraxacum officinale*), and small-fruited bulrush.

## Soils

Soil in Wetland 26B was examined to a depth of 16 inches and consists of two layers. The upper layer is a 12-inch layer of black (10YR 2/1) sandy loam. The lower layer is a very dark grayish brown (2.5Y 4/2) sand with yellowish brown (10YR 5/6) redoximorphic features. Soil in the area is mapped as Alderwood and Kitsap soils.

## Buffer

The area west of the wetland between the trail and Lake Sammamish is developed with single-family residences. Wetland 26A is located to the east, but connectivity is disrupted by the trail. Lawn, landscaped areas (e.g., rhododendrons, camellias, and magnolias), and gravel parking areas exist to the north and south of the wetland providing disturbed connectivity to Zackuse Creek. Vegetation in the upland buffer includes maintained lawn, apple (*Malus sp.*), reed canarygrass, and giant horsetail.

## Wetland Classification

Wetland 26B is classified as a palustrine emergent wetland under the Cowardin et al. (1979) system and slope under the HGM system (Null et al. 2000; Hruby 2004). Wetland 26B is rated a Category IV according to the City of Sammamish and Ecology. This wetland scored 12 points on the Washington State Wetland Rating System for Western Washington rating form (4 points for water quality functions, 0 points for hydrologic functions, and 8 points for habitat functions) (see Appendix B). The required buffer width is 50 feet for Category IV wetlands in the city of Sammamish (SMC 21A.50.290).

## Wetland Determination

Biologists flagged the boundary of Wetland 26B where indicators of hydrophytic vegetation, hydric soils, and wetland hydrology were present. The wetland edge generally corresponds with a topographic break where one or more of the wetland indicators was lacking.

### *Wetland 26C*

Subbasin: Monohon

USFWS Classification: Palustrine Scrub-shrub/Palustrine Emergent

HGM Classification: Depressional

Ecology Rating: Category IV

City of Sammamish Rating: Category IV

Data Plots: 26C-SP1, 26C-SP2, 26C-SP3

Stations: 423+25 to 424+25

Size: 0.03 acre

---

Wetland 26C is located on the west side of the trail south of Zackuse Creek and is located entirely within the project area (see Figures 3-2e and 3-2f).

**Exhibit 16**  
**SSDP2016-00415**

## Hydrology

Wetland hydrology is maintained by seasonally high groundwater. Soil saturation in the upper 12 inches was observed during site visits conducted in October 2007 and March 2014, along with standing water in micro-depressions. This wetland has a saturated only water regime.

## Vegetation

Wetland 26C has two vegetation communities: scrub-shrub and emergent. A majority of the wetland is a maintained lawn (emergent community), with creeping buttercup, bluegrass, dandelion, bentgrass, and white clover. The scrub-shrub community is dominated by red-osier dogwood, Pacific ninebark, rose, Douglas spirea, and willow. Other species include Himalayan blackberry, reed canarygrass, small-fruited bulrush, creeping buttercup, and giant horsetail.

## Soils

Soil in Wetland 26C was examined to a depth of 16 inches and consists of a single layer of very dark gray (10YR 3/1) gravelly sandy loam with (10YR 3/6) redoximorphic features. Soil in the area is mapped as Alderwood and Kitsap soils.

## Buffer

East Lake Sammamish Shore Lane SE borders the wetland to the west and single-family residences exist between East Lake Sammamish Shore Lane SE and Lake Sammamish. The trail exists on the eastern border of the wetland. Vegetated buffer with gravel parking areas is present on the north and south ends of the wetland providing disturbed connectivity to Zackuse Creek. Vegetation in the buffer between trail and wetland includes Pacific silver fir (*Abies amabilis*), apple, reed canarygrass, maintained lawn, Himalayan blackberry, and giant horsetail.

## Wetland Classification

Wetland 26C is classified as a palustrine scrub-shrub/palustrine emergent wetland under the Cowardin et al. (1979) system and depressional under the HGM system (Null et al. 2000; Hruby 2004). Wetland 26C is rated a Category IV according to the City of Sammamish and Ecology. This wetland scored 27 points on the Washington State Wetland Rating System for Western Washington rating form (4 points for water quality functions, 12 points for hydrologic functions, and 11 points for habitat functions) (see Appendix B). The required buffer width is 50 feet for Category IV wetlands in the city of Sammamish (SMC 21A.50.290).

## Wetland Determination

Biologists flagged the boundary of Wetland 26C where indicators of hydrophytic vegetation, hydric soils, and wetland hydrology were present. The wetland edge generally corresponds with a topographic break where one or more of the wetland indicators was lacking.

## Wetland 26D

Subbasin: Monohon

USFWS Classification: Palustrine Scrub-shrub/Palustrine Emergent

HGM Classification: Riverine/Lake-fringe

Ecology Rating: Category III

City of Sammamish Rating: Category III

Data Plots: 26D-SP1

Stations: 431+75 to 432+75

Size: Approximately 0.13 acre

---

Wetland 26C is located on the west side of the trail associated with Unnamed Stream 9, located partially within the project area and sloping west to Lake Sammamish (see Figure 3-2f). This wetland is part of a wetland/stream restoration site with large woody debris (LWD), recent plantings, and irrigation on site. The buffer to the north has also been planted between the wetland and nearby house.

## Hydrology

Unnamed Stream 9 and Lake Sammamish are the primary sources of hydrology, along with a shallow groundwater table. Unnamed Stream 9 flows out of a pipe under the trail at the northeast corner of the wetland, then flows south along the east boundary, turning west in the southeast corner where it continues to Lake Sammamish. Soil saturation to the surface, along with standing water in micro-depressions, was observed during the site visit conducted in March 2014. Water was also flowing in the channel of Unnamed Stream 9. This wetland has occasionally flooded and saturated-only water regimes.

## Vegetation

Wetland 26D has two vegetation communities: scrub-shrub and emergent. Planted vegetation includes red-osier dogwood, Pacific ninebark, and ovate spikerush (*Eleocharis ovata*). Other species include red alder (primarily saplings with few large trees near stream outlet to lake), willow, American speedwell, reed canarygrass, common rush, watercress, small-fruited bulrush, and hardstem bulrush (*Schoenoplectus acutus*).

## Soils

Soil in Wetland 26D consists of a black (10YR 2/1) gravelly silt loam over a light brownish gray (2.5Y 6/2) with strong brown (7.5YR 5/8) redoximorphic features. Soil in the area is mapped as Ragnar-Indianola association.

## Buffer

A rock wall and quarry spalls immediately border the wetland and stream system along the south and east edges. Single-family residences exist farther to the south and north and the trail is to the east. The planted buffer to the north consists of western redcedar, Douglas fir, Sitka spruce, rose, tall Oregon grape (*Mahonia aquifolium*), red-osier dogwood, and willow.

## Wetland Classification

Wetland 26D is classified as a palustrine scrub-shrub/palustrine emergent wetland under the Cowardin et al. (1979) system and riverine/lake-fringe under the HGM system (Null et al. 2000; Hruby 2004). Wetland 26D is rated a Category III according to the City of Sammamish and Ecology. This wetland scored 48 points on the Washington State Wetland Rating System for Western Washington rating form (16 points for water quality functions, 18 points for hydrologic functions, and 14 points for habitat

functions) (see Appendix B). The required buffer width is 50 feet for Category III wetlands scoring less than 20 points for habitat functions in the city of Sammamish (SMC 21A.50.290).

## Wetland Determination

Biologists flagged the boundary of Wetland 26D where indicators of hydrophytic vegetation, hydric soils, and wetland hydrology were present. The wetland edge generally corresponds with a topographic break where one or more of the wetland indicators was lacking.

### *Wetland 28A*

Subbasin: Panhandle

USFWS Classification: Palustrine Forested

HGM Classification: Depressional/Riverine

Ecology Rating: Category IV

City of Sammamish Rating: Category IV

Data Plots: 28A-SP1, 28A-SP2

Stations: 448+75 to 450+50

Size: 0.08 acre

---

Wetland 28A is located on the east side of the trail between the trail and East Lake Sammamish Parkway and approximately 800 feet north of the intersection of East Lake Sammamish Parkway and NE 7th Court, associated with Unnamed Stream 10 (see Figures 3-2f and 3-2g). The wetland is located entirely within the project area.

## Hydrology

Wetland hydrology is maintained by groundwater seeps and the overbank flow of Unnamed Stream 10. Water from seeps is retained in a ditch along the toe of the trail prism. The stream flows from a culvert that passes under East Lake Sammamish Parkway and discharges into the wetland. The stream flows northwest through the wetland and exits through a culvert passing west under the trail. Ditches running along the toe of the trail prism drain the northern and southern portions of the wetland and feed into Unnamed Stream 10. Soil saturation in the upper 12 inches was observed during site visits conducted in November 2007. This wetland has permanently flooded and saturated only water regimes.

## Vegetation

Wetland 28A has a forested vegetation community dominated by red alder, Himalayan blackberry, and salmonberry. A layer of emergent vegetation is present in the understory and includes giant horsetail, reed canarygrass, and common ladyfern.

## Soils

Soil in Wetland 28A was examined to a depth of 18 inches and consists of three layers. The upper layer is a 10-inch layer of very dark gray (10YR 3/1) loam. The lower layers are a 2-inch layer of very dark gray loamy sand over a black (10YR 2/1) sandy loam. Soil in the area is mapped as Alderwood and Kitsap soil.

## Buffer

Buffer around Wetland 28A is limited by residential development. Single-family residences are found to the west of the trail. East Lake Sammamish Parkway is to the east of the wetland. The areas north and south of the wetland are paved and used for parking. A small patch of upland buffer is found at the northeast corner of the wetland. Vegetation in the buffer is dominated by Himalayan blackberry, red

alder, and western swordfern. The buffer between the trail and the wetland consists primarily of maintained herbaceous vegetation.

## Wetland Classification

Wetland 28A is classified as a palustrine forested wetland under the Cowardin et al. (1979) system and depressional/riverine under the HGM system (Null et al. 2000; Hruby 2004). Wetland 28A is rated a Category IV according to the City of Sammamish and Ecology. This wetland scored 27 points on the Washington State Wetland Rating System for Western Washington rating form (8 points for water quality functions, 6 points for hydrologic functions, and 13 points for habitat functions) (see Appendix B). The required buffer width is 50 feet for Category IV wetlands in the city of Sammamish (SMC 21A.50. 290).

## Wetland Determination

Biologists flagged the boundary of Wetland 28A where indicators of hydrophytic vegetation, hydric soils, and wetland hydrology were present. The wetland edge generally corresponds with a topographic break where one or more of the wetland indicators was lacking.

### *Wetland 28B*

Subbasin: Panhandle

USFWS Classification: Palustrine Scrub-Shrub

HGM Classification: Depressional/Slope

Ecology Rating: Category IV

City of Sammamish Rating: Category IV

Data Plots: 28B-SP1, 28B-SP2

Stations: 436+75 to 437+50

Size: 0.02 acre

---

Wetland 28B is located on the east side of the trail, approximately 300 feet north of the intersection of East Lake Sammamish Parkway and Louis Thompson Road (see Figure 3-2f). The wetland is located entirely within the project area.

## Hydrology

Wetland hydrology is maintained by a culvert that passes under East Lake Sammamish Parkway and discharges into the wetland. Water flows from east to west through the wetland and then flows south in a ditch that runs along the toe of the trail prism. The water then flows through a culvert that passes under the trail and is piped to Lake Sammamish. Soil saturation was observed in the upper 12 inches during site visits conducted in November 2007. This wetland has a saturated only water regime.

## Vegetation

Wetland 28B contains a palustrine scrub-shrub vegetation community. Vegetation in the wetland includes Douglas spirea, Himalayan blackberry, cluster rose, and reed canarygrass.

## Soils

Soil in Wetland 28B was examined to a depth of 18 inches and consists of two layers. The upper layer is a 12-inch layer of a very dark gray (10YR 3/1) silt loam. The lower layer is very dark gray (10YR 3/1) silt loam with red (2.5YR 4/6) redoximorphic features. Soil in the area is mapped as mixed alluvial land.

## Buffer

Wetland 28B is located in a vegetated corridor between the trail and East Lake Sammamish Parkway. Forested upland exists to the south and shrubs with few trees are to the north. Vegetation in the upland buffer includes Himalayan blackberry, bigleaf maple, giant horsetail, and reed canarygrass. The buffer to the south provides connectivity to Wetland 26A. East Lake Sammamish Parkway is located to the east of the wetland. The trail, East Lake Sammamish Shore Lane, and single-family residences are to the west of the wetland. The buffer between the trail and the wetland consists primarily of maintained reed canarygrass.

## Wetland Classification

Wetland 28B is classified as a palustrine scrub-shrub wetland under the Cowardin et al. (1979) system and depressional/slope under the HGM system (Null et al. 2000; Hruby 2004). Wetland 28B is rated a Category IV according to the City of Sammamish and Ecology. This wetland scored 21 points on the Washington State Wetland Rating System for Western Washington rating form (12 points for water quality functions, 3 points for hydrologic functions, and 6 points for habitat functions) (see Appendix B). The required buffer width is 50 feet for Category IV wetlands in the city of Sammamish (SMC 21A.50.290).

## Wetland Determination

Biologists flagged the boundary of Wetland 28B where indicators of hydrophytic vegetation, hydric soils, and wetland hydrology were present. The wetland edge generally corresponds with a topographic break where one or more of the wetland indicators was lacking.

### *Wetland 28C*

Subbasin: Panhandle

USFWS Classification: Palustrine Scrub-shrub/Palustrine Emergent

HGM Classification: Depressional

Ecology Rating: Category IV

City of Sammamish Rating: Category IV

Data Plots: 28C-SP1

Stations: 455+50 to 456+25

Size: 0.02 acre

---

Wetland 28C is located on the east side of the trail approximately 800 feet south of the intersection of East Lake Sammamish Parkway and Inglewood Hill Road (see Figure 3-2g). The entire wetland is located entirely within the project area.

## Hydrology

Wetland hydrology is primarily maintained by local area runoff from the trail and the slope to the east. Two pipes are also located at the north end of the wetland. The wetland drains into an Unnamed Stream 13, which flows west through the wetland from a culvert passing under East Lake Sammamish Parkway. The stream continues west into a culvert that passes under the trail. Soil saturation in the upper 12 inches was observed during site visits conducted in November 2007. Wetland 28C has saturated only and occasionally flooded water regimes.

## Vegetation

Wetland 28C contains scrub-shrub and emergent vegetation communities. The scrub-shrub community consists of cotoneaster creeping into the wetland from the edge and buffer. The emergent community is



dominated by giant horsetail and common ladyfern. Other species include small-fruited bulrush, creeping buttercup, watercress, little western bittercress, climbing nightshade, European mountain ash (*Sorbus aucuparia*), and Himalayan blackberry.

## Soils

Soil in Wetland 28C was examined to a depth of 18 inches and consists of two layers. The upper layer is a 12-inch layer of very dark gray (10YR 3/1) silt loam. The lower layer is a 6-inch layer of very dark gray gravelly loam. Soil in the area is mapped as mixed alluvial land.

## Buffer

Wetland 28C is located in a narrow corridor between the trail and East Lake Sammamish Parkway; most of the surrounding area is developed. Gravel parking areas exist to the north, east, and south. The trail is located to the west of the wetland. The small vegetated areas are maintained consisting of creeping buttercup, giant horsetail, hedge false bindweed, and common ladyfern.

## Wetland Classification

Wetland 28C is classified as a palustrine scrub-shrub/palustrine emergent wetland under the Cowardin et al. (1979) system and depressional under the HGM system (Null et al. 2000; Hruby 2004). Wetland 28C is rated a Category IV according to the City of Sammamish and Ecology. This wetland scored 28 points on the Washington State Wetland Rating System for Western Washington rating form (12 points for water quality functions, 3 points for hydrologic functions, and 13 points for habitat functions) (see Appendix B). The required buffer width is 50 feet for Category IV wetlands in the city of Sammamish (SMC 21A.50.290).

## Wetland Determination

Biologists flagged the boundary of Wetland 28C where indicators of hydrophytic vegetation, hydric soils, and wetland hydrology were present. The wetland edge generally corresponds with a topographic break where one or more of the wetland indicators was lacking.

### *Wetland 28D*

Subbasin: Panhandle

USFWS Classification: Palustrine Emergent

HGM Classification: Depressional

Ecology Rating: Category IV

City of Sammamish Rating: Category IV

Data Plots: 28D-SP1, 28D-SP2

Stations: 453+00 to 453+25

Size: <0.01 acre

---

Wetland 28D is small depression located on the east side of the trail, between the trail and a gravel driveway, and approximately 1,200 feet north of the intersection of East Lake Sammamish Parkway and NE 7th Court (see Figure 3-2g). The entire wetland is located entirely within the project area.

## Hydrology

Wetland hydrology is maintained by local area runoff and a shallow groundwater table. A catch basin is located south of the wetland and water discharges to Unnamed Stream 11 and Wetland 29C. Soil saturation to the surface was observed during site visits conducted in November 2007 and September

2013. Inundation was also observed in September 2013. Wetland 28D has saturated only and permanently flooded water regimes.

## Vegetation

Wetland 28D contains an emergent vegetation community. Dominant vegetation consists primarily of reed canarygrass, mowed Himalayan blackberry, and common duckweed in standing water. Other vegetation present includes giant horsetail, fringed willowherb, and hedge false bindweed.

## Soils

Soil in wetland 28D was examined to a depth of 18 inches and consists of a single layer of black (10YR 2/1) gravelly loam. Soil in the area is mapped as a mixed alluvial land.

## Buffer

Wetland 28D is surrounded by a gravel driveway to the north, east, and south. The trail borders the wetland to the west. Buffer around the wetland is a few feet wide and vegetation consists of maintained Himalayan blackberry, English ivy, hedge false bindweed, and some giant horsetail.

## Wetland Classification

Wetland 28D is classified as a palustrine emergent wetland under the Cowardin et al. (1979) system and depressional under the HGM system (Null et al. 2000; Hruby 2004). Wetland 28D is rated a Category IV according to the City of Sammamish and Ecology. This wetland scored 16 points on the Washington State Wetland Rating System for Western Washington rating form (2 points for water quality functions, 5 points for hydrologic functions, and 9 points for habitat functions) (see Appendix B). The required buffer width is 50 feet for Category IV wetlands in the city of Sammamish (SMC 21A.50.290).

## Wetland Determination

Biologists flagged the boundary of Wetland 28D where indicators of hydrophytic vegetation, hydric soils, and wetland hydrology were present. The wetland edge generally corresponds with a topographic break where one or more of the wetland indicators was lacking.

### *Wetland 28E*

Subbasin: Panhandle

USFWS Classification: Palustrine Emergent

HGM Classification: Depressional

Ecology Rating: Category III

City of Sammamish Rating: Category III

Data Plots: 28E-SP1, 28E-SP2

Stations: 445+50 to 446+50

Size: 0.02 acre

---

Wetland 28E is a closed depression located on the east side of the trail, between the trail and East Lake Sammamish Parkway, and approximately 450 feet north of the intersection of East Lake Sammamish Parkway and NE 7th Court (see Figures 3-2f and 3-2g). The entire wetland is located entirely within the project area.

## Hydrology

Wetland hydrology is maintained by local area runoff and a shallow groundwater table. No surface water inlets or outlets were identified during field investigations. Soil saturation to the surface, pockets

of inundation, and standing water in the ditch were observed during the November 2013 site visit. Wetland 28E has a saturated only water regime.

### Vegetation

Wetland 28E has an emergent vegetation community primarily dominated by reed canarygrass with American speedwell in the ditch. Common ladyfern, hedge false bindweed, and cluster rose are also present.

### Soils

Soil in Wetland 28E consists of a 6-inch black (10YR 2/1) sandy loam over a very dark gray (10YR 3/1) gravelly sandy loam with dark yellowish brown (10YR 3/6) redoximorphic features and cobbles. Soil in the area is mapped as Everett very gravelly sandy loam.

### Buffer

Wetland 28E is located in a narrow corridor between the trail and East Lake Sammamish Parkway; most of the surrounding area is developed. Disturbed and residential areas are located to the north. The trail is located to the west. Vegetated areas to the east and south are dominated by bigleaf maple in the overstory and Himalayan blackberry in the understory. Other species include red alder, thimbleberry, cluster rose, beaked hazelnut, giant horsetail, and bracken fern.

### Wetland Classification

Wetland 28E is classified as a palustrine emergent wetland under the Cowardin et al. (1979) system and depressional under the HGM system (Null et al. 2000; Hruby 2004). Wetland 28E is rated a Category III according to the City of Sammamish and Ecology. This wetland scored 42 points on the Washington State Wetland Rating System for Western Washington rating form (16 points for water quality functions, 18 points for hydrologic functions, and 8 points for habitat functions) (see Appendix B). The required buffer width is 50 feet for Category III wetlands with a habitat score less than 20 points in the city of Sammamish (SMC 21A.50.290).

### Wetland Determination

Biologists flagged the boundary of Wetland 28E where indicators of hydrophytic vegetation, hydric soils, and wetland hydrology were present. The wetland edge generally corresponds with a topographic break where one or more of the wetland indicators was lacking.

### *Wetland 29B*

Subbasin: Panhandle

USFWS Classification: Palustrine Emergent

HGM Classification: Slope

Ecology Rating: Category IV

City of Sammamish Rating: Category IV

Data Plots: 29B-SP1, 29B-SP2

Stations: 457+25 to 458+25

Size: Approximately 0.03 acre

---

Wetland 29B is a maintained yard located on the west side of the trail approximately 700 feet south of the intersection of East Lake Sammamish Parkway and Inglewood Hill Road (see Figure 3-2g). Wetland 29B extends outside of the project area to the west.

## Hydrology

Wetland hydrology is maintained by seasonally high groundwater. The wetland slopes toward Lake Sammamish. Saturation in the upper 12 inches was observed during site visits conducted in November 2007 and March 2014. This wetland has a saturated only water regime.

## Vegetation

Wetland 29B contains an emergent vegetation community that is maintained as lawn. Identified species include common velvetgrass, swordleaf rush (*Juncus ensifolius*), creeping buttercup, giant horsetail, white clover, narrowleaf plantain (*Plantago lanceolata*), and small-fruited bulrush.

## Soils

Soil in Wetland 29B was examined to a depth of 16 inches and consists of two layers. The upper layer is a 6-inch black (10YR 2/1) loam. The lower layer is a very dark grayish brown (10YR 3/2) gravelly sandy loam with light yellowish brown (10YR 6/4) and yellowish brown (10YR 5/8) redoximorphic features and cobbles. Soil in the area is mapped as Alderwood gravelly sandy loam.

## Buffer

Wetland 29B is situated in a residentially developed area. Single-family residences and associated yards are located to the north, west, and south. Surrounding upland buffer consists of maintained yards vegetated with unidentified grasses and ornamental shrubs. Wetland 29D is located to the east of the wetland, but connectivity is disrupted by the trail.

## Wetland Classification

Wetland 29B is classified as a palustrine emergent wetland under the Cowardin et al. (1979) system and slope under the HGM system (Null et al. 2000; Hruby 2004). Wetland 29B is rated a Category IV according to the City of Sammamish and Ecology. This wetland scored 7 points on the Washington State Wetland Rating System for Western Washington rating form (2 points for water quality functions, 0 point for hydrologic functions, and 5 points for habitat functions) (see Appendix B). The required buffer width is 50 feet for Category IV wetlands in the city of Sammamish (SMC 21A.50.290).

## Wetland Determination

Biologists flagged the boundary of Wetland 29B where indicators of hydrophytic vegetation, hydric soils, and wetland hydrology were present within the project area. The wetland edge generally corresponds with a topographic break where one or more of the wetland indicators was lacking.

### *Wetland 29C*

Subbasin: Panhandle

USFWS Classification: Palustrine Forested

HGM Classification: Lake-fringe/Slope

Ecology Rating: Category III

City of Sammamish Rating: Category III

Data Plots: 29C-SP1, 29C-SP2

Stations: 452+75 to 454+00

Size: Approximately 0.06 acre

---

Wetland 29C is located on the west side of the trail approximately 1,000 feet north of the intersection of East Lake Sammamish Parkway and NE 7th Court (see Figure 3-2g). Wetland 29C extends outside of the project area to the west.

**Exhibit 16**  
**SSDP2016-00415**

**000775**<sub>3-61</sub>

## Hydrology

Wetland hydrology is maintained by seasonally high groundwater. The wetland is sloped and drains toward Lake Sammamish. An Unnamed Stream 11 flows west through the wetland from a culvert that passes under the trail. Soil saturation in the upper 12 inches was observed during site visits conducted in November 2007 and March 2014. Wetland 29C has a saturated only water regime.

## Vegetation

Wetland 29C contains a forested vegetation community with understory shrubs. The vegetation in the wetland is dominated by black cottonwood, Pacific willow, salmonberry, Pacific ninebark, Himalayan blackberry, English ivy, giant horsetail, and scouring rush. Other species include red alder, black twinberry, red-osier dogwood, slough sedge, and common ladyfern.

## Soils

Soil in Wetland 29C was examined to a depth of 16 inches and consists of two layers. The upper layer is a 12-inch layer of black (10YR 2/1) peaty loam. The lower layer is a mixed sand and gravel. Soil in the area is mapped as Kitsap silt loam.

## Buffer

Wetland 29C is located in a residentially developed area. Single-family residences exist to the north and the south. The wetland is bordered on the west by Lake Sammamish and the trail is located to the east. Some small patches of vegetated upland buffer exist at the northeast and southeast corner of the wetland. Vegetation in the buffer includes giant horsetail, field horsetail, English ivy, salmonberry, red alder, bigleaf maple, Douglas fir, Himalayan blackberry, western swordfern, and bamboo (*Bambusa vulgaris*) near the stream.

## Wetland Classification

Wetland 29C is classified as a palustrine forested wetland under the Cowardin et al. (1979) system and lake-fringe/slope under the HGM system (Null et al. 2000; Hruby 2004). Wetland 29C is rated a Category III according to the City of Sammamish and Ecology. This wetland scored 45 points on the Washington State Wetland Rating System for Western Washington rating form (18 points for water quality functions, 12 points for hydrologic functions, and 15 points for habitat functions) (see Appendix B). The required buffer width is 50 feet for Category III wetlands scoring less than 20 points for habitat functions in the city of Sammamish (SMC 21A.50.290).

## Wetland Determination

Biologists flagged the boundary of Wetland 29C where indicators of hydrophytic vegetation, hydric soils, and wetland hydrology were present within the project area. The wetland edge generally corresponds with a topographic break where one or more of the wetland indicators was lacking.

### Wetland 29D

Subbasin: Panhandle

USFWS Classification: Palustrine Scrub-Shrub/Palustrine Emergent

HGM Classification: Depressional/Slope

Ecology Rating: Category IV

City of Sammamish Rating: Category IV

Data Plots: 29D-SP1, 29D-SP2, 29D-SP3

Stations: 457+75 to 460+50

Size: 0.08 acre

---

Wetland 29D is located on the east side of the trail, between the trail and East Lake Sammamish Parkway, approximately 600 feet south of the intersection of East Lake Sammamish Parkway and Inglewood Hill Road (see Figure 3-2g). Wetland 29D extends outside the trail right-of-way to the east.

### Hydrology

Wetland hydrology is maintained by groundwater seeps and local area runoff. A culvert discharges water into the wetland at the south end. Water collects in a ditch located at the toe of the trail prism. Water flows both north and south in the ditch. At the north end, water passes through a culvert under a residential driveway, and feeds into Stream 0143L (South Fork). At the south end, water is conveyed under the trail to Wetland 29B. Water from the groundwater seeps and inundation in the ditch was observed during the September 2103 site visits. The sloped portion of the wetland has a saturated only water regime, while the ditched portion has an occasionally flooded water regime.

### Vegetation

Wetland 29D has two vegetation communities: scrub-shrub and emergent. The scrub-shrub community consists of Himalayan blackberry and beaked hazelnut. Vegetation in the emergent community includes common ladyfern, small-fruited bulrush, giant horsetail, and English ivy.

### Soils

Two soil pits were examined in Wetland 29D. The first wetland soil pit (W29D-SP1) was dug in the emergent vegetation community and consists of a 12-inch layer of black (10YR 2/1) gravelly loam. The second soil pit was dug in the scrub-shrub vegetation community and consists of an 18-inch layer of black (10YR 2/1) mucky loam. Soil in the area is mapped as Alderwood gravelly sandy loam.

### Buffer

Wetland 29D is situated in a vegetated corridor between the trail and East Lake Sammamish Parkway. The trail is adjacent to the wetland on the western boundary. Vegetated buffer exists to the south and to the east between the wetland and the parkway. Vegetation includes beaked hazelnut, bigleaf maple, salmonberry, black cottonwood, and Pacific madrone. Wetland 30B exists to the north; however, connectivity is disrupted by a residential driveway.

### Wetland Classification

Wetland 29D is classified as a palustrine scrub-shrub/palustrine emergent wetland under the Cowardin et al. (1979) system and depressional/slope under the HGM system (Null et al. 2000; Hruby 2004). Wetland 29D is rated a Category IV according to the City of Sammamish and Ecology. This wetland scored 25 points on the Washington State Wetland Rating System for Western Washington rating form (12 points for water quality functions, 1 point for hydrologic functions, and 12 points for habitat

functions) (see Appendix B). The required buffer width is 50 feet for Category IV wetlands in the city of Sammamish (SMC 21A.50.290).

## Wetland Determination

Biologists flagged the boundary of Wetland 29D where indicators of hydrophytic vegetation, hydric soils, and wetland hydrology were present. The wetland edge generally corresponds with a topographic break where one or more of the wetland indicators was lacking.

### *Wetland 30B*

Subbasin: Panhandle

USFWS Classification: Palustrine Forested

HGM Classification: Depressional/Slope

Ecology Rating: Category III

City of Sammamish Rating: Category III

Data Plots: 30B-SP1, 30B-SP2

Stations: 461+00 to 463+50

Size: 0.20 acre

---

Wetland 30B is located on the east side of the trail approximately 200 feet south of the intersection of East Lake Sammamish Parkway and Inglewood Hill Road (see Figure 3-2g). The wetland and buffer has been planted as part of a wetland mitigation effort for the interim trail. Wetland 30B extends outside of the trail right-of-way to the east.

## Hydrology

Wetland hydrology is maintained primarily by groundwater seeps from the slope to the east. Stream 0413L discharges into the wetland and diverges into two channels flowing north (North Fork) and south (South Fork) along the toe of the trail prism. The streams pass under the trail through culverts located at the north and south ends of the wetland and flow west toward Lake Sammamish. Soil saturation at the surface was observed throughout most of the wetland during site visits conducted in January 2008 and September 2013. Wetland 30B has saturated only and seasonally inundated water regimes.

## Vegetation

Wetland 30B has a forested vegetation community dominated by red alder, red-osier dogwood, and Pacific ninebark. Other species include Oregon ash, western redcedar, salmonberry, Himalayan blackberry, common ladyfern, climbing nightshade, water parsley (*Oenanthe sarmentosa*), reed canarygrass, giant horsetail, scouring rush, and bigleaf maple. Shrubs and trees have been planted in the wetland.

## Soils

Soil in Wetland 30B was examined to a depth of 17 inches and consists of three layers. The upper layer is a 5-inch layer of black (10YR 2/1) silt loam. The middle layer is a 5-inch layer of very dark gray (10YR 3/1) sandy gravelly loam. The lower layer is black (7.5YR 2. 5/1) muck. Soil in the area is mapped as Alderwood gravelly sandy loam.

## Buffer

Wetland 30B is situated in a vegetated corridor between the trail and East Lake Sammamish Parkway. The trail borders the wetland to the west and a residential driveway is to the south. A vegetated upland buffer exists to the north and the east. Vegetation in the buffer includes salmonberry, Himalayan

Exhibit 16  
SSDP2016-00415

blackberry, western swordfern, trailing blackberry, bigleaf maple, and giant horsetail. The buffer to the west (between the wetland and the trail) is maintained herbaceous vegetation. Wetland 29D is located to the south of the wetland, but connectivity is disrupted by a driveway.

### Wetland Classification

Wetland 30B is classified as a palustrine forested wetland under the Cowardin et al. (1979) system and depression/slope under the HGM system (Null et al. 2000; Hruby 2004). Wetland 30B is rated a Category III according to the City of Sammamish and Ecology. This wetland scored 46 points on the Washington State Wetland Rating System for Western Washington rating form (22 points for water quality functions, 10 points for hydrologic functions, and 14 points for habitat functions) (see Appendix B). The required buffer width is 50 feet for Category III wetlands scoring less than 20 points for habitat functions in the city of Sammamish (SMC 21A.50.290).

### Wetland Determination

Biologists flagged the boundary of Wetland 30B where indicators of hydrophytic vegetation, hydric soils, and wetland hydrology were present. The wetland edge generally corresponds with a topographic break where one or more of the wetland indicators was lacking.

## 3.3 Streams

Seventeen stream crossings were identified in the project area (Table 3-3; Figures 3-2a through 3-2g). Most of the streams in the South Sammamish Segment B project area are small and perennial, but little public resource information is available. Generally, these are short streams with silt or sand substrates that flow through culverts or conduits that are barriers to fish passage. For the majority of these streams, information is lacking on fish presence or absence. Field reconnaissance was used to determine the quality and quantity of available salmonid habitat (where access was allowed); therefore, the likelihood of fish use was assessed qualitatively based on the professional judgment of Parametrix biologists familiar with local hydrologic and fish habitat conditions. This approach was conservative because it is extremely unlikely that all streams that meet the criteria for presumed fish presence and/or contain fish habitat features are currently occupied.

All of the drainage structures in the project area, including the ones that convey the streams identified in this report, were evaluated for their suitability for future fish passage improvements (Parametrix 2015). Several of these streams were removed from consideration for structure replacement, based on a lack of characteristics (hydrology, catchment area, adequate channel, and buffer width, etc.) that could support a viable enhanced stream or restore a former stream. Nonetheless, the 17 streams identified in this analysis meet the definition of “streams” as specified in SMC 21A.15.1240.



**Table 3-3. Summary of Streams Crossing the Project Area**

Stream Name	Station	City of Sammamish Stream Classification <sup>a</sup>	Buffer Width <sup>b</sup> (feet)
Unnamed Stream 4	316+20	F	150
Unnamed Stream 5	316+95	F	150
Unnamed Stream 6	356+90	F	150
Unnamed Stream 7	367+00	F	150
Pine Lake Creek	379+10, 379+15	F	150
Unnamed Stream 8 (South Fork)	384+25	F	150
Unnamed Stream 8 (North Fork)	386+60	F	150
Stream 0155	401+75	F	150
Ebright Creek	411+85, 411+90	F	150
Zackuse Creek	424+60	F	150
Unnamed Stream 9	432+80	F/Np	150
George Davis	441+35, 441+40	F	150
Unnamed Stream 10	449+95	F	150
Unnamed Stream 11	452+95	F	150
Unnamed Stream 13	455+80	F	150
Stream 0143L (South Fork)	460+25	F	150
Stream 0143L (North Fork)	464+25	F	150

<sup>a</sup> Per SMC 21A.15.1240. F = Fish-bearing (salmonids only); Np = Non-fish-bearing, perennial.

<sup>b</sup> Per SMC 21A.50.330.

### *Unnamed Stream 4*

Subbasin: Monohon

Stream Classification: Type F

Station: 316+20

Unnamed Stream 4 is the southernmost stream in the South Segment B project area, near Unnamed Stream 5 (see Figure 3-2b). This stream receives off-site flow from adjacent hillside properties and roadways, including East Lake Sammamish Parkway to the east. It also receives water from Wetland 15BC. The stream channel flows north from a culvert into Wetland 15BC, then turns west to a pipe under the Interim Use Trail. After emerging from the pipe under the trail, the stream flows off site on the adjacent property in an open channel and a short distance through two pipes before emptying to Lake Washington. Riparian vegetation consists of lawn, English ivy, disturbed areas from adjacent property owners, a few deciduous and coniferous trees, salmonberry, scouring rush, and Wetland 15BC. Unnamed Stream 4 meets the criteria for presumed fish presence and is therefore classified as a Type F stream. The required buffer width for Type F streams in the city of Sammamish is 150 feet (SMC 21A.50.330).

---

### *Unnamed Stream 5*

Subbasin: Monohon

Stream Classification: Type F

Station: 316+95

---

Unnamed Stream 5 is in the southern portion of the South Segment B project area, near Unnamed Stream 4 (see Figure 3-2b). This stream receives off-site flow from adjacent hillside properties and roadways, including East Lake Sammamish Parkway to the east. It also receives water from Wetlands 15BC and 15A. The stream channel flows south from a culvert into Wetland 15BC, then turns west to a pipe under the Interim Use Trail. After emerging from the pipe under the trail, the stream flows along the south side of Wetland 15A before emptying to Lake Washington. Riparian vegetation consists of lawn, English ivy, disturbed areas from adjacent property owners, a few deciduous and coniferous trees, and Wetlands 15A and 15BC. Unnamed Stream 5 meets the criteria for presumed fish presence and is therefore classified as a Type F stream. The required buffer width for Type F streams in the city of Sammamish is 150 feet (SMC 21A.50.330).

### *Unnamed Stream 6*

Subbasin: Monohon

Stream Classification: Type F

Station: 356+90

---

Unnamed Stream 6 is in the southern portion of the South Segment B project area, near the intersection of East Lake Sammamish Place SE and SE 16th Street (see Figure 3-2c). This stream receives off-site flow from adjacent hillside properties and roadways, including East Lake Sammamish Place SE and East Lake Sammamish Parkway SE to the southeast. It also receives water from Wetlands 21B and 21AC. The stream enters the project area from the southeast into Wetland 21B, then flows into a pipe under the Interim Use Trail. After emerging from the pipe under the trail, the stream continues in a landscaped channel in Wetland 21AC before emptying to Lake Washington. Riparian vegetation consists of native forested wetland vegetation (Wetland 21B) and landscaped yards and lawns. Unnamed Stream 6 meets the criteria for presumed fish presence and is therefore classified as a Type F stream. The required buffer width for Type F streams in the city of Sammamish is 150 feet (SMC 21A.50.330).

### *Unnamed Stream 7*

Subbasin: Monohon

Stream Classification: Type F

Station: 367+00

---

Unnamed Stream 7 is north of the intersection of East Lake Sammamish Parkway SE and SE 14th Street, south of Pine Lake Creek (see Figure 3-2d). This stream receives off-site flow from adjacent hillside properties and roadways, including East Lake Sammamish Parkway SE to the east. The stream enters the project area from the east, flows adjacent to a small portion of Wetland 22AB, then west under the Interim Use Trail through a pipe. After emerging from the pipe under the trail, the stream continues through developed properties before emptying to Lake Washington. Riparian vegetation consists of native forested wetland vegetation (Wetland 22AB) to the southeast, some trees with an understory of Himalayan blackberry to the northeast, and developed residential properties west of the trail. Unnamed Stream 7 meets the criteria for presumed fish presence and is therefore classified as a Type F stream. The required buffer width for Type F streams in the city of Sammamish is 150 feet (SMC 21A.50.330).

## Pine Lake Creek

Subbasin: Pine Lake

Stream Classification: Type F

Stations: 379+10, 379+15

---

Pine Lake Creek is a 2.84-mile-long stream in the Pine Lake subbasin. WDFW (2016a) indicates that kokanee (*Oncorhynchus nerka*), coho (*O. kisutch*), and winter-run steelhead (*O. mykiss*) have been documented in the stream; the presence of sockeye<sup>4</sup> and fall-run Chinook salmon (*O. tshawytscha*) has been modeled. Records indicate that the lower reaches of Pine Lake Creek support spawning by late-run kokanee salmon (Berge and Higgins 2003). Sockeye salmon or stray Chinook salmon may also use the lower reaches of the stream. Resident cutthroat trout (*O. clarki*) and rainbow trout (*O. mykiss*) are reported to spawn and rear throughout the stream to its headwaters, with resident-only fish present above river mile (RM) 1.8 (King County 1990). This likely refers to Kanim Creek (a tributary to Pine Lake Creek) because the outlet of Pine Lake typically dries up in the late summer and fall, leaving a dry channel at least several hundred yards to the site of a now-removed outlet screen structure (WDFW file records, Mill Creek). Excellent riffle/pool habitat remains in the lower reaches, especially where the stream descends from the plateau to Lake Sammamish. During stream surveys in 2001 and 1999, no fish were observed in the stream within 100 feet on either side of the project corridor.

The Lake Sammamish Kokanee Work Group (2014) identifies Pine Lake Creek as a primary spawning stream for kokanee, one of four streams in the Lake Sammamish basin that has supported the vast majority of spawning by late-run kokanee in recent years. Replacement or improvement of the culverts under the Interim Use Trail and at East Lake Sammamish Shore Lane SE is included on a list of suggested stream restoration and enhancement projects needed to help improve the health of native kokanee populations (Lake Sammamish Kokanee Work Group 2014).

At the Interim Use Trail (i.e., the former railbed), the stream is diverted under the railroad ballast through two 36-inch concrete culverts. During field surveys conducted for this study, one of the culverts was found to be partially filled with gravel at the upstream opening. The WDFW Fish Passage and Diversion Screening Inventory Database identifies these culverts as a partial barrier to fish passage. The stream experiences 25- and 100-year flood flows of 64 and 78 cubic feet per second (cfs), respectively. Approximately 150 feet downstream of the Interim Use Trail, the stream passes through a 36-inch round concrete culvert under East Lake Sammamish Shore Lane. The stream empties to Lake Sammamish approximately 500 feet downstream of the Interim Use Trail (see Figure 3-2d).

Two root wads are present in the stream channel immediately downstream of the Interim Use Trail. In 1999, the King County Department of Natural Resources and Parks placed approximately 10 logs in and across the stream channel in this reach and planted riparian vegetation in an effort to increase habitat diversity. Downstream of East Lake Sammamish Shore Lane, the King County Department of Natural Resources and Parks has placed eight 4-inch pieces of LWD within the stream, as part of a restoration project. Riparian vegetation consists of black cottonwood, reed canarygrass, giant horsetail, ferns, and Himalayan blackberry. Pine Lake Creek is associated with Wetlands W24A and W24B.

Channel morphology within 100 feet of the corridor consists of riffle/glide/pool combinations. Substrate composition is suitable for salmonid spawning upstream of the Interim Use Trail, with cobble and gravel as

---

<sup>4</sup> Sockeye salmon and kokanee are two forms of the same species. Sockeye are anadromous, migrating to marine waters before returning to freshwater to spawn. Kokanee, in contrast, remain in stream and lake habitats their entire lives.

the predominant substrate. However, the plunge pool immediately downstream of the Interim Use Trail culverts appears to contain only silt and sand.

Approximately 50 feet upstream of the Interim Use Trail, the stream passes under East Lake Sammamish Parkway, flowing through a 4-foot by 3-foot concrete box culvert and a 36-inch round corrugated metal pipe. All of the streamflow appears to pass through the box culvert, with no flow in the pipe. In the pool located downstream of the box culvert outlet, two large root wads provide bank stabilization and instream fish habitat. The WDFW Fish Passage and Diversion Screening Inventory Database identifies the culvert under East Lake Sammamish Parkway as a total barrier to fish passage.

Pine Lake Creek is classified as a Type F stream with a required buffer width of 150 feet (SMC 21A.50.330).

### *Unnamed Stream 8 (South Fork, North Fork)*

Subbasin: Monohon

Stream Classification: Type F

Stations: 384+25, 386+60

---

Unnamed Stream 8 is in the vicinity of the intersection of East Lake Sammamish Parkway SE and SE 8th Street, north of Pine Lake Creek (see Figure 3-2d). This stream receives off-site flow from adjacent hillside properties and roadways, including East Lake Sammamish Parkway SE to the east. The stream enters the project area from the southeast, flowing into Wetland 24A on the east side of the Interim Use Trail. The stream diverges into two separate channels. The southern channel (South Fork) flows northwest in a pipe under the trail to Wetland 24B then continues through residential properties to Lake Sammamish. The northern channel (North Fork) flows parallel to the trail through a pipe under a residential roadway and then into Wetland 24C. From there, the stream changes direction and flows into a pipe under the trail that continues to Lake Sammamish. Riparian vegetation in the project area is mostly wetland vegetation (described above for Wetlands 24A, 24B, and 24C) with mowed grass, Himalayan blackberry, English ivy, and reed canarygrass. Unnamed Stream 8 meets the criteria for presumed fish presence and is therefore classified as a Type F stream. The required buffer width for Type F streams in the city of Sammamish is 150 feet (SMC 21A.50.330).

### *Stream 0155*

Subbasin: Monohon

Stream Classification: Type F

Station: 401+75

---

Stream 0155 is located north of the intersection of East Lake Sammamish Parkway SE and SE 8th Street, south of Ebright Creek (see Figure 3-2e). This stream receives off-site flow from adjacent hillside properties and roadways to the east, including East Lake Sammamish Parkway SE, and from a large wetland across the parkway (labeled as East Lake Sammamish #64 under King County's wetland inventory). The stream enters the project area from the southeast, flowing into Wetland 25A on the east side of the Interim Use Trail. The water flows southwest through Wetland 25A to a catch basin with a trash rack and is piped northwest under the Interim Use Trail and adjacent residential properties before it enters Lake Sammamish. Riparian vegetation in the project area is mostly wetland vegetation (described above for Wetland 25A) with Himalayan blackberry, hedge false bindweed, reed canarygrass, and lawn with landscaped trees and shrubs. A driveway disrupts connectivity between Wetland 25A and Wetland 25B to the north. The presence of fall-run Chinook, winter-run steelhead, coho, and sockeye is modeled in the stream (WDFW 2016a). Stream 0155 meets the criteria for presumed fish presence and is therefore classified as a Type F stream. The required buffer width for Type F streams in the city of Sammamish is 150 feet (SMC 21A.50.330).

## *Ebright Creek*

Subbasin: Thompson

Stream Classification: Type F

Stations: 411+85, 411+90

---

Ebright Creek is located in the Thompson subbasin (see Figure 3-2e). WDFW (2016a) indicates that kokanee, coho, winter-run steelhead, and sockeye have been documented in the stream, and the presence of fall-run Chinook is modeled. Late-run kokanee are known to spawn in Ebright Creek, and coho salmon (spawning and rearing) and sockeye salmon (spawning) may be present in the lower reaches downstream of a man-made fish barrier (Berge and Higgins 2003). Ebright Creek also supports cutthroat trout (spawning and rearing) and rainbow trout (spawning and rearing) throughout its 2.65-mile length (King County 1990). In the lower reaches, the stream has characteristics that favor spawning and rearing by coho salmon and spawning by sockeye and kokanee salmon (King County 1990). Farther upstream, the gradient sometimes approaches 5 percent through the ravines, forming tiered or staircase features that result in patch gravel and small-volume pools that are favored by trout (King County 1990). During stream surveys in 1999, six adult kokanee salmon (25 to 35 centimeters in length) were observed spawning within 10 feet of the former railbed and two redds were observed. An adult coho salmon carcass was also found on the stream bank, 5 feet to the east of the former railbed. On December 9, 1999, two adult coho salmon spawners were observed in the stream adjacent to the former railbed. The King County Volunteer Salmon Watcher Program reported over 100 kokanee between RM 0.2 and RM 0.9 during November and December 2001 (Vanderhoof 2002). In addition, one coho salmon was reported at RM 0.2.

The Lake Sammamish Kokanee Work Group (2014) identifies Ebright Creek as a primary spawning stream for kokanee, one of four streams in the Lake Sammamish basin that has supported the vast majority of spawning by late-run kokanee in recent years. Replacement or improvement of the culverts under the Interim Use Trail is included on a list of suggested stream restoration and enhancement projects needed to help improve the health of native kokanee populations (Lake Sammamish Kokanee Work Group 2014).

Channel morphology downstream of the Interim Use Trail (i.e., the former railbed) is a riffle/pool combination. Pool quality is excellent, with two pools directly downstream of the project corridor. The stream banks immediately below the corridor are stable, having been stabilized with the placement of three pieces of LWD (10 to 50 feet long, 18 to 24 inches in diameter) and large boulders. More LWD has been added in the stream channel downstream of the Interim Use Trail.

At the Interim Use Trail, the stream flows through two 36-inch concrete culverts, both of which are in good condition and unblocked. The stream undergoes 25- and 100-year flood flows of 39 and 45 cfs, respectively. However, the culverts beneath the Interim Use Trail may block fish migration at high flows (White 1999). The WDFW Fish Passage and Diversion Screening Inventory Database identifies these culverts as a partial barrier to fish passage.

Substrate composition consists of 20 percent cobble, 50 percent gravel, and 30 percent sand and silt, forming habitat suitable for adult salmonid spawning. However, a substantial concentration of sediment and fines (greater than 80 percent composition) was observed at the tail end of the pool immediately downstream of the culverts crossing the Interim Use Trail. Although the stream does not appear to be downcutting its bed in the area, the plunge pool below the culverts is retaining sediment, sand, and fines.

Upstream of the Interim Use Trail, 10 feet to the east, the stream is partially blocked with vegetation. The vegetation blockage may be reducing stream flows through the culverts, contributing to sediment deposition in the plunge pool.

Riparian vegetation consists of giant horsetail, red alder, Himalayan blackberry, bigleaf maple, reed canarygrass, and Scotch broom. Ebright Creek is associated with Wetland 25F.

Ecology (1994) identified an erosion problem in Ebright Creek upstream from East Lake Sammamish Parkway to the impassable barrier at RM 0.45. Bed and bank erosion in the upper and middle reaches of the stream result in sedimentation of salmonid spawning and rearing habitat in lower reaches and of culverts under East Lake Sammamish Parkway (Ecology 1994). The WDFW Fish Passage and Diversion Screening Inventory Database identifies the culvert under East Lake Sammamish Parkway as a partial barrier to fish passage.

Ebright Creek is classified as a Type F stream with a required buffer width of 150 feet (SMC 21A.50.330).

### *Zackuse Creek*

Subbasin: Monohon

Stream Classification: Type F

Station: 424+60

---

Zackuse Creek lies in the Monohon subbasin (see Figure 3-2f). WDFW (2016a) indicates that coho salmon have been documented in the stream, and the presence of winter steelhead, sockeye, and fall Chinook is modeled. The stream likely supports cutthroat trout (spawning and rearing), and it may support late-run kokanee salmon and coho salmon spawning near the stream mouth. The stream is 1.18 miles in length, but only 0.05 mile is accessible to anadromous or adfluvial fish (King County 1990). There is a culvert barrier at East Lake Sammamish Parkway (King County 1990). At one time, this stream may have supported coho, kokanee, and/or sockeye salmon in the lower reaches prior to the creation of fish barrier(s) near the mouth. During the large run of Lake Sammamish kokanee in 2012-13, up to 60 mature adults were observed in Zackuse Creek, although it is unclear whether most of the fish spawned in the creek or moved to another tributary to spawn (Lake Sammamish Kokanee Work Group 2014). During stream surveys in 1999, no fish were observed within 100 feet of the Interim Use Trail.

The Lake Sammamish Kokanee Work Group (2014) identifies Zackuse Creek as a small secondary stream that has the potential for kokanee spawning. Replacement or improvement of the culverts under East Lake Sammamish Shore Lane, the Interim Use Trail, and East Lake Sammamish Parkway is included on a list of suggested stream restoration and enhancement projects needed to improve the health of native kokanee populations (Lake Sammamish Kokanee Work Group 2014).

Downstream of the Interim Use Trail, channel morphology is a riffle/glide combination. Substrate composition in this downstream reach consists of 40 percent cobble and 60 percent sand and gravel, which is suitable for salmonid spawning. The stream banks appear to be stable, with no evidence of deep erosional sides or soil sloughing.

No LWD is present in the downstream reach of Zackuse Creek. A broken clay pipe lies across the channel approximately 50 feet downstream of the Interim Use Trail. The stream passes through a bridge under a private driveway before entering a culvert that runs underneath a residence. Eventually, the stream emerges and flows into Lake Sammamish.

The stream flows underneath the Interim Use Trail in a 36-inch concrete culvert, which is in good condition. There is no sediment in the culvert or culvert outlet blockage. The stream experiences 25- and 100-year flood flows of 28 and 43 cfs, respectively. Flow depth in the culvert averages 2.5 inches. The culvert beneath the Interim Use Trail may act as a partial fish barrier (White 1999). The WDFW Fish Passage and Diversion Screening Inventory Database identifies this culvert as a partial barrier to fish passage. At the culvert outlet, the stream has created a plunge pool. From the culvert, the stream drops 12 to 18 inches into a 3-foot by 10-foot plunge pool. This is the only pool within 100 feet of the corridor.

EXIST 10  
SSDP2016-00415

000785

Riparian vegetation consists of giant horsetail, Himalayan blackberry, reed canarygrass, and red alder, which are typical of a disturbed riparian zone. Bigleaf maple and Scotch broom are also present. Upstream from the Interim Use Trail, the stream channel is choked with Himalayan blackberry and forms a part of Wetland 26A. East Lake Sammamish Parkway lies 75 feet east of the Interim Use Trail and slightly uphill. Beyond East Lake Sammamish Parkway is another large wetland. In this wetland, the stream channel is braided and choked with vegetation. The culvert beneath East Lake Sammamish Parkway is partially blocked with sediment and vegetation. The WDFW Fish Passage and Diversion Screening Inventory Database identifies the culvert under East Lake Sammamish Parkway as a partial barrier to fish passage.

Zackuse Creek is classified as a Type F stream with a required buffer width of 150 feet (SMC 21A.50.330).

### *Unnamed Stream 9*

Subbasin: Monohon

Stream Classification: Type F / Type Np

Station: 432+80

---

Unnamed Stream 9 is located in the vicinity of the intersection between East Lake Sammamish Parkway SE and Louis Thompson Road NE, south of George Davis Creek (see Figure 3-2f). This stream receives off-site flow from adjacent hillside properties and roadways, including East Lake Sammamish Parkway SE and Louis Thompson Road NE to the east. The stream enters the project area from the east and flows over a quarry spall-lined slope (no defined channel) to the Interim Use Trail, where it is piped under the trail into Wetland 26D west of the trail. Unnamed Stream 9 flows out of the pipe under the trail at the northeast corner of the wetland, then flows south along the eastern boundary before turning west in the southeast corner and continuing to Lake Sammamish. West of the trail, this stream is part of a wetland/stream restoration site with LWD, recent plantings, and irrigation. The riparian buffer to the northwest has also been planted between the wetland and nearby house. Riparian vegetation east of the trail is primarily Himalayan blackberry. Unnamed Stream 9 meets the criteria for presumed fish presence downgradient of the trail and is therefore classified as a Type F stream. Upgradient of the trail the stream lacks a defined channel on the steep quarry spall slope and is classified as Type Np. The required buffer width for Type F streams in the city of Sammamish is 150 feet, and the buffer for Type Np streams is 75 feet (SMC 21A.50.330).

### *George Davis Creek*

Subbasin: Inglewood

Stream Classification: Type F

Stations: 441+35, 441+40

---

George Davis Creek lies in the Inglewood subbasin (see Figure 3-2f). This stream is also known locally as Inglewood Creek or Eden Creek (King County 1994). WDFW (2016a) indicates coho and winter steelhead have been documented in the stream, and the presence of sockeye and fall Chinook is modeled. The stream is believed to support late-run kokanee salmon, coho salmon (rearing), cutthroat trout (spawning and rearing), and rainbow trout (spawning and rearing) (Williams et al. 1975; King County 1990). The Lake Sammamish Kokanee Work Group (2014) identifies George Davis Creek as a small secondary stream that has the potential for kokanee spawning. Adult kokanee have occasionally been observed in George Davis Creek since 2009, following a project that restored approximately 100 feet at the mouth of Lake Sammamish. Approximately 15 kokanee were observed spawning in the stream (Lake Sammamish Kokanee Work Group 2014).

The stream is 3.46 miles in length, but only about 100 feet is accessible to anadromous or adfluvial fish (Lake Sammamish Kokanee Work Group 2014). At one time, this stream likely supported coho, kokanee, and/or sockeye salmon in the lower reaches prior to the creation of fish barriers near its mouth. Sedimentation and the stream culvert under an adjacent residence severely limit the amount of usable salmonid habitat in the portion downstream of the Interim Use Trail.

A section of the stream downstream of the Interim Use Trail has been piped under a private driveway and a house. This culvert also acts as a partial barrier to fish passage (Ecology 1994). Underneath the Interim Use Trail, there are two concrete culverts, 24 and 36 inches in diameter, which are 50 percent blocked by sediment. The WDFW Fish Passage and Diversion Screening Inventory Database identifies these culverts as a potential but unevaluated barrier to fish passage. Pool quality and quantity are poor. Because of restricted access, no survey was performed in the reach downstream of King County right-of-way. However, lakeshore spawning by kokanee salmon may occur near the outlet of the stream (Ecology 1994).

Upstream of the Interim Use Trail, a culvert under East Lake Sammamish Parkway also creates a barrier to salmonid migration, as does a second culvert at RM 0.81 (King County 1990). The WDFW Fish Passage and Diversion Screening Inventory Database identifies the culvert under East Lake Sammamish Parkway as a total barrier to fish passage. Upstream of the Parkway, between RMs 0.2 and 0.8, the stream channel contains sufficient amounts of LWD and habitat conditions that are generally favorable for salmonids (Ecology 1994). In general, the upper tributary streams in the Inglewood Basin all have some rearing habitat available for resident cutthroat trout and some limited spawning areas (Ecology 1994).

The stream reach upstream of East Lake Sammamish Parkway (beyond the impassable barriers) has been identified as a problem area for erosion/sedimentation and water quality (Ecology 1994). Salmonid habitat on the Sammamish Plateau has been degraded by past agricultural practices, such as ditching, clearing, and poor pasture management; only short reaches have not been straightened or dredged to drain fields more rapidly or to eliminate wetlands. The stream above RM 2.0 has been grossly modified through channelization and dredging (King County 1990).

The 25- and 100-year flood flows for this stream are 35 and 42 cfs, respectively. Near the Interim Use Trail, the channel has been deeply eroded (greater than 10 feet), exposing tree roots on the bank. Riparian vegetation is dominated by bigleaf maple and Himalayan blackberry. Other species observed include Douglas fir, Portuguese laurel, English laurel, hedge false bindweed, English ivy, beaked hazelnut, thimbleberry, and western swordfern. The stream has downcut its channel and exposed a gravel/cobble substrate in the streambed near the Interim Use Trail.

George Davis Creek is classified as a Type F stream with a required buffer width of 150 feet (SMC 21A.50.330).

### *Unnamed Stream 10*

Subbasin: Panhandle

Stream Classification: Type F

Station: 449+95

---

Unnamed Stream 10 is located south of the intersection between East Lake Sammamish Parkway SE and NE Inglewood Hill Road, north of George Davis Creek (see Figures 3-2f and 3-2g). This stream receives off-site flow from adjacent hillside properties and roadways, including East Lake Sammamish Parkway SE to the east. The stream enters the project area from the east and flows into Wetland 28A, where it turns north and enters a pipe under the Interim Use Trail. West of the trail, the stream flows through a quarry spall-lined channel with some gravel, then enters a plastic pipe under a walkway associated with the adjacent residential property before its outlet to Lake Sammamish. The riparian area east of the trail is

**Exhibit 16**  
**SSDP2016-00415**

**000787** 3-73



dominated by wetland vegetation associated with Wetland 28A, and improved areas for parking used by adjacent residential properties. The riparian area west of the trail consists of improved areas associated with the adjacent residential property (i.e., structures, sport court, and landscaped yard). Unnamed Stream 10 meets the criteria for presumed fish presence and is therefore classified as a Type F stream. The required buffer width for Type F streams in the city of Sammamish is 150 feet (SMC 21A.50.330).

#### *Unnamed Stream 11*

Subbasin: Panhandle

Stream Classification: Type F

Station: 452+95

---

Unnamed Stream 11 is located south of the intersection between East Lake Sammamish Parkway SE and NE Inglewood Hill Road (see Figure 3-2g). This stream receives off-site flow from adjacent hillside properties and roadways, including East Lake Sammamish Parkway SE to the east. The stream enters the project area from the east and continues west. It is associated with Wetlands 28D and 29C. Much of the riparian area is developed as part of the adjacent residential properties with little native vegetation. Unnamed Stream 11 meets the criteria for presumed fish presence and is therefore classified as a Type F stream. The required buffer width for Type F streams in the city of Sammamish is 150 feet (SMC 21A.50.330).

#### *Unnamed Stream 13*

Subbasin: Panhandle

Stream Classification: Type F

Station: 455+80

---

Unnamed Stream 13 is located south of the intersection between East Lake Sammamish Parkway SE and NE Inglewood Hill Road, south of Stream 0143L (see Figure 3-2g). This stream receives off-site flow from adjacent hillside properties and roadways, including East Lake Sammamish Parkway SE to the east. The stream enters the project area from the east and continues west. It is associated with Wetland 28C. Much of the riparian area is developed as part of the adjacent residential properties and little native vegetation is present. Unnamed Stream 13 meets the criteria for presumed fish presence and is therefore classified as a Type F stream. The required buffer width for Type F streams in the city of Sammamish is 150 feet (SMC 21A.50.330).

#### *Stream 0143L (South Fork, North Fork)*

Subbasin: Panhandle

Stream Classification: Type F

Stations: 460+25, 464+25

---

Stream 0143L is located south of the intersection of East Lake Sammamish Parkway SE and NE Inglewood Hill Road, near the northern terminus of the project area (see Figure 3-2g). WDFW (2016a) does not identify this as a fish-bearing stream. The Lake Sammamish Kokanee Work Group (2014) identifies Stream 0143L as likely to have limited potential for kokanee spawning. The stream receives off-site flow from adjacent hillside properties and roadways, including East Lake Sammamish Parkway SE and NE Inglewood Hill Road to the east. The stream enters the project area from the east and hits a dissipating rock structure that splits the stream into two channels, the South Fork and North Fork. The South Fork flows south along the Interim Use Trail for a short distance before crossing under the trail in a pipe to the west side, where it continues in an incised channel to Lake Sammamish. Riparian habitat along the South Fork is dominated by upland forest with a disturbed understory and developed residential areas farther south. The North Fork flows north adjacent to the trail and along Wetland 30B

before turning west to a pipe under the Interim Use Trail. The stream continues in an incised channel west of the trail through an area used as a community beach. Riparian habitat along the North Fork consists mostly of native forest with wetland vegetation (Wetland 30B) on the east side of the trail and upland forest with a disturbed understory west of the trail. Stream 0143L meets the criteria for presumed fish presence and is therefore classified as a Type F stream. The required buffer width for Type F streams in the city of Sammamish is 150 feet (SMC 21A.50.330).

### 3.4 Lake Sammamish

Lake Sammamish, with a surface area of approximately 4,900 acres, is one of the largest lakes in the Puget Sound Basin (King County 1990). The lake receives flow primarily from Issaquah Creek and discharges north through the Sammamish River to Lake Washington, Lake Union, and Puget Sound. Most of the watershed is located within the King County urban growth area boundary and is (or is proposed to be) developed with high-density residential and commercial land uses (King County 1994; KCCFM 2000). Within the project area residential development has been concentrated between the East Lake Sammamish Parkway and the lakeshore.

Lake Sammamish serves as a rearing environment and migratory pathway for both resident and anadromous salmonids, with Chinook, coho, sockeye, and kokanee salmon; steelhead; and coastal cutthroat trout likely to be found in the lake and its tributaries (King County 1990; Pfeifer 1992). Other than one unconfirmed anecdotal account, there is no documentation of bull trout presence in the Lake Sammamish Watershed. Tributary thermal regimes are unsuitable for reproduction by this species, and there is no known local spawning population in low-elevation tributaries of either Lake Washington or Lake Sammamish (WDFW 1998). Lake Sammamish also contains a diverse population of resident non-salmonid species, including largemouth bass (*Micropterus salmoides*), yellow perch (*Perca flavescens*), brown bullhead (*Ameiurus nebulosus*), and black crappie (*Pomoxis nigromaculatus*) (King County 1990).

Lake Sammamish is a shoreline of the state, regulated under the City of Sammamish SMP (effective August 31, 2011). The project area has a Shoreline Residential shoreline designation. According to SMP 25.06.020(9), Lake Sammamish has a 50-foot shoreline setback. Residential structures and associated landscaping cover the majority of the setback in the project area, with a small area of native forest and a disturbed understory near the northern terminus.

### 3.5 Fish and Wildlife Habitat Conservation Areas

Based on a review of existing information and site conditions, the following areas with which state or federally designated endangered, threatened, or sensitive species have a primary association are present in the project area:

- Pine Lake Creek, Ebright Creek, and George Davis Creek, where steelhead (listed as threatened under the Endangered Species Act [ESA]) have been documented

Please note that, since the submittal of the CAS, in December 2016, the Washington Fish and Wildlife Commission removed the bald eagle from the list of state sensitive species (WAC 232-12-011). As a result, bald eagles are no longer among the species for which FWHCAs are established in the City of Sammamish, per SMC 21A.15.468.

No other areas with which state or federally designated endangered, threatened, or sensitive species have a primary association are present in the project area. There are no state natural area preserves, natural resource conservation areas, or wildlife habitat corridors in the project area.

According to SMC 21A.50.325(1), if a fish and wildlife habitat conservation area is also classified as a stream, lake, pond, or a wetland, then the appropriate protection standards for the stream, lake, pond, or wetland shall apply and habitat management shall be addressed as part of the stream, lake, pond, or wetland review. The protection standards for Pine Lake Creek, Ebright Creek, and George Davis Creek (which are designated as fish and wildlife habitat conservation areas based on the documented presence of steelhead) are specified in the pertinent discussions in Section 3.3, above. Habitat conservation areas that are lakes are governed by the requirements of the Sammamish SMP (SMC 21A.50.325(3)). See Sections 3.2, 3.3, and 3.4 for information on wetlands, streams, and Lake Sammamish.

Pileated woodpeckers use forested habitats in the project area and have been observed in the northern portion of the trail corridor (TWC 2017). However, WDFW (2016b) has not identified any pileated woodpecker breeding areas in the project area. Although the City code (SMC 21A.15.468) does not establish FWHCAs for pileated woodpeckers, the City has directed the County to add pileated woodpecker to the FWHCA sections of the CAS and to protect pileated woodpecker habitat.

WDFW has developed recommendations for the management of habitat for pileated woodpeckers in urban and suburban areas, such as the project area. Recommendations applicable to the proposed project include (1) targeting larger forest patches with large trees and snags for conservation during the planning process and (2) retaining or creating snags and retaining live trees in the largest size classes available. Areas that provide opportunities for the implementation of these recommendations are available in the northern portion of the trail corridor.

### 3.6 Critical Aquifer Recharge Areas

City of Sammamish CARA maps identify Class 3 wellhead protection zones in the southern portion of the project area (see Figure 3-2a).

## 4. IMPACT ASSESSMENT

This section describes the extent and type of permanent and temporary impacts on critical areas and associated buffers that will occur as a result of the proposed project. Wetland buffers, stream buffers, and the shoreline setback often overlap in the project area. Where overlap occurs, impacts are calculated and presented in descending order of priority from wetland buffer, stream buffer, and lastly shoreline setback.

### 4.1 Wetlands

Permanent and temporary impacts on wetlands and buffers are unavoidable (Table 4-1; Appendix D). This section describes the extent and type of temporary and permanent impacts on wetland and wetland buffers that will occur as a result of constructing the proposed trail project. Only impacts on areas that are defined solely as wetland buffers are reported in this section.

**Table 4-1. Summary of Impacts on Wetlands and Buffers**

Wetland	Ecology/ Sammamish Rating <sup>a</sup>	Wetland		Buffer	
		Perm. Impacts acres (SF)	Temp. Impacts acres (SF)	Perm. Impacts acres (SF)	Temp. Impacts acres (SF)
15A	III	-	0.02 (679)	0.04 (1,807)	0.04 (1,828)
15BC	IV	-	0.01 (216)	0.05 (2,099)	0.08 (3,667)
15D	IV	-	0.03 (1,247)	0.03 (1,169)	0.07 (3,048)
15E <sup>b</sup>	IV	0.05 (2,022)	-	-	-
18C	III	-	-	0.03 (1,193)	0.04 (1,622)
19A <sup>b</sup>	IV	0.01 (278)	-	-	-
19B	III	-	0.01 (532)	0.07 (3,228)	0.10 (4,307)
20A <sup>b</sup>	III	0.05 (2,087)	-	-	-
21AC	III	-	0.01 (574)	0.10 (4,298)	0.09 (3,913)
21B	III	-	<0.01 (52)	<0.01 (7)	0.02 (825)
21D	IV	-	-	< 0.01 (99)	0.03 (1,440)
22AB	III	-	0.03 (1,426)	0.14 (5,941)	0.11 (4,949)
22CD	IV	-	0.01 (286)	0.06 (2,752)	0.07 (3,156)
22E <sup>b</sup>	IV	<0.01 (191)	-	-	-
23A	IV	-	0.01 (265)	0.01 (285)	0.03 (1,130)
23B	III	<0.01 (65)	0.01 (626)	0.04 (1,830)	0.03 (1,410)
23C	III	-	0.01 (383)	0.03 (1,299)	0.05 (2,341)
24A	III	-	0.06 (2,583)	0.01 (593)	0.04 (1,937)
24B	III	0.05 (2,301)	0.11 (4,840)	0.09 (4,096)	0.02 (1,027)
24C	III	-	0.02 (992)	0.08 (3,496)	0.29 (12,811)
25A	III	-	0.04 (1,617)	0.08 (3,306)	0.18 (7,709)
25B	III	-	0.02 (679)	0.08 (3,293)	0.13 (5,765)
25C	III	-	0.02 (790)	0.08 (3,440)	0.11 (4,988)
25F	III	-	<0.01 (244)	0.02 (1,061)	0.07 (2,963)
26A	III	<0.01 (9)	0.09 (4,100)	0.14 (6,086)	0.35 (15,434)
26B	IV	-	<0.01 (99)	0.02 (744)	0.03 (1,444)
26C	IV	0.01 (455)	0.01 (497)	0.03 (1,102)	0.05 (2,233)

**Exhibit 16**  
**SSDP2016-00415**  
**000791**

**Table 4-1. Summary of Impacts on Wetlands and Buffers**

Wetland	Ecology/ Sammamish Rating <sup>a</sup>	Wetland		Buffer	
		Perm. Impacts acres (SF)	Temp. Impacts acres (SF)	Perm. Impacts acres (SF)	Temp. Impacts acres (SF)
26D	III	-	<0.01 (186)	0.06 (2,753)	0.11 (4,708)
28A	IV	0.01 (175)	0.01 (382)	0.04 (1,779)	0.07 (2,998)
28B	IV	-	<0.01 (156)	0.03 (1,133)	0.02 (882)
28C <sup>b</sup>	IV	0.02 (837)	-	-	-
28D <sup>b</sup>	IV	<0.01 (201)	-	-	-
28E	III	-	0.01 (323)	0.04 (1,588)	0.04 (1,803)
29B	IV	0.01 (295)	0.01 (477)	0.02 (931)	0.02 (775)
29C	III	-	<0.01 (27)	0.01 (581)	0.04 (1,687)
29D	IV	0.01 (464)	0.03 (1,105)	0.01 (600)	0.01 (485)
30B	III	-	0.01 (218)	0.07 (2,908)	0.09 (4,045)
<b>Total</b>		<b>0.22 (9,380)</b>	<b>0.59 (25,581)</b>	<b>1.51 (65,596)</b>	<b>2.46 (107,320)</b>

<sup>a</sup> Hruby (2004), as specified in SMC 21A.15.1415

<sup>b</sup> Wetland impacted in entirety

Perm. = Permanent, Temp. = Temporary, SF = square feet. Note that the sums of individual acre values may not match total values due to rounding errors.

### 4.1.1 Permanent Wetland Impacts

Permanent impacts to wetlands occur when there is a permanent loss of wetland area, typically as a result of paving or grading. Thirteen wetlands will be permanently affected by the proposed project, totaling 0.22 acre (see Table 4-1 and Appendix D). Six of these wetlands will be affected in their entirety (Wetlands 15E, 19A, 20A, 22E, 28C, and 28D), all of which are 0.05 acre or less. The majority of impacts to wetland are to palustrine emergent wetlands that are near the Interim Use Trail and are currently maintained as part of current trail activities, or are maintained by adjacent property owners as yard. Four of these are Category III wetlands with the other nine being Category IV wetlands.

### 4.1.2 Temporary Wetland Impacts

Construction activities that will result in temporary wetland impacts include culvert replacements, associated stormwater drainage facilities, construction access, and installation of silt and construction fencing. A total of 29 wetlands will be temporarily affected during construction. The net impact area is 0.59 acre, with impacts ranging from less than 0.01 acre to 0.11 acre. Vegetation in these areas often consists of reed canarygrass, giant horsetail, Himalayan blackberry, disturbance-tolerant herbaceous species, native shrubs, or maintained yard. Temporarily disturbed wetlands will be restored by reseeded or replanting with appropriate native species when construction activities are completed.

### 4.1.3 Permanent Wetland Buffer Impacts

Permanent impacts occur when there is a permanent loss of wetland buffer area, typically as a result of paving or permanent clearing. Construction activities that will result in permanent wetland buffer impacts include trail widening, driveway reconfigurations, stair replacements, culvert replacements, and stormwater drainage features. The project will permanently affect portions of 31 wetland buffers (see Table 4-1). Approximately 1.51 acres of wetland buffer will be eliminated as a result of trail widening and realignment. The buffers of Wetlands 22AB and 26A have the largest affected area (0.14 acre each),

Exhibit 16

SSDP2016-00415

000793

which accounts for approximately 19 percent of the total permanent buffer impacts. The remaining affected wetland buffer areas are 0.10 acre or less. The majority of the wetland buffers to be affected by the project are narrow linear swathes immediately adjacent to the Interim Use Trail vegetated with herbaceous species that are currently disturbed by routine trail maintenance activities, landscaped plants associated with adjacent residences, Himalayan blackberry, and native trees and shrubs. Minimal effects on wetland buffer functions are anticipated.

#### 4.1.4 Temporary Wetland Buffer Impacts

The buffer of 31 wetlands will be temporarily affected during construction. In total, construction will temporarily affect 2.46 acres of wetland buffer (see Table 4-1). Temporary impacts on wetland buffers consist of minor clearing and grading outside of the trail footprint to enable project construction. These construction work areas along the edge of the proposed trail have been conservatively estimated for this project. Once construction is complete, regrowth is expected relatively quickly from the seeds, roots, tubers, stems, and other propagules in the soil under the temporary impact areas. The majority of the wetland buffers to be cleared and graded are primarily vegetated with herbaceous species that are currently disturbed by routine trail maintenance activities, landscaped plants associated with adjacent residences, Himalayan blackberry, and native trees and shrubs. Temporarily disturbed buffers will be restored by reseeding or replanting with appropriate native species when construction activities are completed.

## 4.2 Streams

Although the project was designed with specific features to avoid and minimize impacts on critical areas, some unavoidable impacts on streams and stream buffers will result from the trail widening, realignment, and drainage improvements (Table 4-2; Appendix D). Stream buffers, wetland buffers, and the shoreline setback overlap in the project area at many locations. Where overlap occurs, impacts are calculated in descending order of priority from wetland buffer, stream buffer, and lastly shoreline setback. Only impacts on areas that are defined solely as stream buffers are reported in this section.

Stream channel and stream buffer impacts can be classified as either permanent or temporary:

- Permanent impacts occur when fill is placed in a stream or a stream is piped, or when a designated stream buffer area is permanently cleared, resulting in a net loss of open stream channel or buffer.
- Stream impacts are considered temporary when a stream is temporarily diverted or relocated to accommodate construction, a stream channel is regraded, or when a designated stream buffer area is temporarily cleared to allow for project construction activities.

Stream channel loss results in permanent loss of instream habitat. Instream habitat directly supports fish and other aquatic life by providing specific physical and biological elements for the rearing, feeding, spawning, and migration of aquatic species.

Stream buffers are also important, contributing both directly and indirectly to the health of streams and the fish that inhabit those streams. Properly functioning stream buffers provide shade and a source of LWD, contribute organic debris to the stream, stabilize stream banks, reduce fine sediment input into streams, filter nutrients and pollutants, and reduce and detain flood waters (Beschta et al. 1987; McDade et al. 1990; Sedell and Beschta 1991). The effectiveness of a stream buffer is dependent on three primary factors: the type of vegetation within the buffer, the density of the vegetation, and the width of the buffer. Mature forest provides the highest level of riparian functions; mature conifer forest provides greater riparian function than mature hardwood forest, particularly LWD recruitment (McDade et al. 1990). Riparian communities dominated by immature forest or shrubs can support some riparian

functions (stream bank stabilization, nutrient input, filtration of fine sediment), although these functions are provided at a significantly lower level than in mature forested systems, and some functions (e.g., LWD recruitment) are almost completely lacking. Likewise, riparian systems consisting of herbaceous vegetation (e.g., grasses) provide minimal riparian functions, particularly in regards to supporting habitat needs of salmonids (cold, clear water; habitat complexity; and instream cover).

#### 4.2.1 Stream Channel Impacts

Stream channels are permanently affected at locations where a stream passes under the trail in a culvert that requires lengthening, or where a stream falls within the footprint of the proposed trail. Based on current design, 24 linear feet (114 square feet) of three streams (Unnamed Streams 7, 8 [South Fork], and 13, all classified as Type F will be permanently lost due to culvert extensions (Table 4-2).

The replacement of culverts on six Type F streams (Pine Lake Creek, Stream 0155, Ebright Creek, Zackuse Creek, George Davis Creek, and Stream 0143L [North Fork]) at six trail crossings will result in a gain of 93 linear feet (681 square feet) of stream channel in those streams. The other eight streams in the project area will have no gain or loss of channel (see Table 4-2). Details on specific culvert replacements are provided below. Detailed depictions of proposed culvert replacements will be included in the engineering design drawings for this project.

Temporary impacts on channels will occur on some streams where regrading is needed for culvert replacements. Regrading of the channel (upstream and downstream) at culvert replacement areas will improve stream profile and slope. Temporary stream bypasses will be used during construction of the new culverts. A small portion (158 square feet) of Unnamed Stream # 10 will be temporarily graded for trail construction. The stream waters will be bypassed in a pipe until construction is complete. After construction the channel will be reconstructed in its current location.

##### Pine Lake Creek (at the trail) (Sta. 379+14)

The existing twin 36-inch concrete culverts are each 32 feet long. The culverts will be replaced by a precast reinforced split box culvert. Pine Lake Creek has an average measured bankfull width of 10.2 feet, and the stream has slopes of approximately 2.5 percent downstream of the culvert. The new culvert will be 14 feet wide, 7 feet high, and 19 feet long. The reduced length of the new culvert will increase the length of open channel stream by 13 feet. The invert of the culvert will be countersunk, and the streambed slope will be approximately 1.5 percent through the culvert. Replacing these two culverts near the mouth of Lake Sammamish will enhance access to approximately 30 feet of upstream habitat between the Interim Use Trail and East Lake Sammamish Parkway, with the potential for access to an additional 10,330 feet of habitat in Pine Lake Creek upstream of East Lake Sammamish Parkway.

##### Pine Lake Creek (downstream of trail)

This segment of the stream is on private property and is not within the trail corridor. The existing culvert is a single 36-inch-diameter concrete culvert that is 41 feet long with a slope of 0.76 percent. The culvert will be replaced by a 32-foot-long box culvert with a 14-foot span and a height of 7 feet. The reduced culvert length of the new culvert will increase the length of open-channel stream by 9 feet. The invert of the culvert will be countersunk, and the streambed slope will transition from 2.91 percent at the culvert inlet to 0.22 percent through the culvert until the slope matches existing grade approximately 20 feet downstream of the culvert outlet.

**Table 4-2. Summary of Impacts on Stream Channels and Buffers**

Stream	City of Sammamish Rating <sup>a</sup>	Stream Channel Perm. Loss		Stream Channel Perm. Gain		Stream Channel Temp. Impact		Stream Buffer	
		Linear Feet	Square Feet	Linear Feet	Square Feet	Linear Feet	Square Feet	Perm. Impact acres (SF)	Temp. Impact acres (SF)
Unnamed 4	F	-	-	-	-	-	-	0.01 (233)	0.01 (640)
Unnamed 5	F	-	-	-	-	-	-	-	-
Unnamed 6	F	-	-	-	-	-	-	-	-
Unnamed 7	F	10	50	-	-	-	-	0.01 (279)	<0.01 (101)
Pine Lake Creek	F	-	-	22	202	-	-	-	-
Unnamed 8 (SF)	F	8	40	-	-	-	-	-	-
Unnamed 8 (NF)	F	-	-	-	-	-	-	-	-
0155	F	-	-	19	95	-	-	-	<0.01 (107)
Ebright Creek	F	-	-	18	160	13	116	0.02 (854)	0.06 (2,752)
Zackuse Creek	F	-	-	15 <sup>b</sup>	90 <sup>b</sup>	80	480	-	-
Unnamed 9	Np	-	-	-	-	-	-	0.04 (1,565)	0.07 (2,901)
George Davis Creek	F	-	-	5	50	10	100	0.04 (1,732)	0.07 (2,870)
Unnamed 10	F	-	-	-	-	45	158	0.01 (513)	0.01 (313)
Unnamed 11	F	-	-	-	-	-	-	<0.01 (85)	0.01 (601)
Unnamed 13	F	6	24	-	-	-	-	0.05 (2,035)	0.06 (2,776)
0143L (SF)	F	-	-	-	-	-	-	0.01 (394)	0.01 (648)
0143L (NF)	F	-	-	14	84	-	-	0.03 (1,450)	0.06 (2,639)
<b>Total</b>		<b>24</b>	<b>114</b>	<b>93</b>	<b>681</b>	<b>148</b>	<b>854</b>	<b>0.21 (9,314)</b>	<b>0.41 (17,705)</b>

<sup>a</sup> SMC 21A.15.1240

<sup>b</sup> Stream channel gains on Zackuse Creek will be offset slightly by the loss of approximately 2.5 linear feet (15 square feet) of stream channel due to a culvert replacement downstream of the project area, for a net gain of 15 feet. Perm. = Permanent, Temp. = Temporary, SF = square feet, NA = not applicable



There are two 6-foot-diameter redwood trees flanking either side of the existing culvert on the downstream end. These two trees will be preserved at the request of the homeowners. As a result, the new culvert will shift to the east of its existing location approximately 6 feet on the upstream end. The downstream side will open up approximately 15 feet of new channel, for a net gain of 9 feet; however, because of the proximity of the trees, the channel will not be full width. Replacing this culvert will improve connectivity to approximately 150 feet of habitat between East Lake Sammamish Shore Lane and the Interim Use Trail.

#### Stream 0155 (Sta. 401+75)

The existing culvert that conveys Stream 0155 under the trail is a 16-inch corrugated plastic pipe. On the east side of the trail, water flows into the top of a type 2 catch basin with a birdcage lid. On the west side of the trail, the pipe connects into a type 2 catch basin with a solid lid. From there, the stream is conveyed to the lake through a 20-inch pipe. The proposed fish passage box culvert will be 19 feet long. The two catch basin structures on either side of the trail will be removed. The catch basin rim on the east side provides a constant overflow elevation for the adjacent wetland. This function will be replaced by adding a rock weir around the entrance to the new culvert. Approximately 9 feet of channel will be opened on the east side. On the west side, the channel will be opened approximately 10 feet to the adjacent driveway. A short retaining wall will be installed along the edge of the driveway to protect the embankment and allow for the short section of open channel between the trail and the driveway.

The bankfull width of Stream 0155 is approximately 5 feet and the proposed box culvert will be 8 feet wide by 8 feet high. The streambed slope through the culvert is approximately 2.8 percent, matching the stream channel elevation on the east end and the assumed pipe invert on the west end. Replacement of the existing culvert will improve connectivity to approximately 130 feet of upstream habitat between the Interim Use Trail and East Lake Sammamish Parkway, with the potential for access to an additional 2,550 feet of habitat upstream of East Lake Sammamish Parkway.

#### Ebright Creek (Sta. 411+90)

Ebright Creek currently crosses under the trail in twin 36-inch concrete culverts, one 34 feet long and the other 37 feet long. Ebright Creek has an average measured bankfull width of 8.9 feet with an average slope downstream of the trail of 2.7 percent. The new box culvert will have a 14-foot span, a height of 7 feet, and a length of 19 feet, thereby increasing the length of open channel by 18 feet. Additionally, approximately 13 feet of stream will be regraded at the culvert outfall. The short regrade will improve the stream profile by allowing the culvert slope to remain similar to existing conditions, and removing the potential of a perched culvert end. The streambed slope will be 1.8 percent through the culvert. Replacing the twin culverts under the trail will improve connectivity to approximately 60 feet of upstream habitat between the Interim Use Trail and East Lake Sammamish Parkway, with the potential for access to an additional 11,200 feet of habitat upstream of East Lake Sammamish Parkway.

#### Zackuse Creek (Sta. 424+60)

The existing culvert that conveys Zackuse Creek under the trail is a 34-foot-long, 36-inch-diameter concrete pipe. Consistent with specifications proposed by R2 Resource Consultants, Inc. (2012), the new box culvert will have a 10-foot span, a height of 8 feet, and a length of 19 feet, thereby increasing the length of open channel by 15 feet. Additionally, approximately 45 feet of open channel will be regraded from the East Lake Sammamish Parkway culvert outlet to the inlet of the trail box culvert, and approximately 35 feet of open channel will be regraded from the outlet of the trail box culvert to the inlet of the East Lake Sammamish Shore Lane box culvert. The regraded stream will have an average slope of approximately 3.4 percent. Replacement of the existing culvert will improve connectivity to approximately 40 feet of upstream habitat between the Interim Use Trail and East Lake Sammamish

Parkway, with the potential for access to an additional 3,320 feet of habitat upstream of East Lake Sammamish Parkway.

#### Zackuse Creek (downstream of trail at East Lake Sammamish Shore Lane)

This segment of the stream is on private property at East Lake Sammamish Shore Lane and is not within the trail corridor. The existing culvert is a small bottomless concrete box that is approximately 2 feet wide by 3 feet tall by 9.5 feet long.

The culvert will be replaced by a 12-foot-long box culvert with a 10-foot span and a height of 5 feet. The extended length of the new culvert will slightly decrease the length of open channel at this crossing, but will allow the road to continue to accommodate vehicular access to private properties. The invert of the culvert will be countersunk, and the streambed slope will continue at the regraded slope of 3.4 percent. Replacing this culvert will improve connectivity to approximately 50 feet of habitat between East Lake Sammamish Shore Lane and the Interim Use Trail.

#### George Davis Creek (Sta. 441+40)

George Davis Creek currently crosses under the trail in a 36-inch concrete culvert that is 24 feet long, and an 18-inch concrete culvert that is 18 feet long. After the first 100 feet of open channel, the stream enters an enclosed system that navigates steep slopes beneath two private properties and East Lake Sammamish Shore Lane for approximately 180 feet before daylighting west of the trail.

The stream has an average measured bankfull width of 10 feet, with moderate slopes upstream of East Lake Sammamish Parkway averaging 3.5 percent, and steeper slopes downstream of East Lake Sammamish Shore Lane estimated up to 12 percent, where the stream is located in an enclosed pipe. The proposed design will install a 19-foot-long, 14-foot-span, 7-foot-rise concrete culvert. The culvert bed will be countersunk, and the streambed slope will be 1.2 percent through the culvert. The reduced culvert length will increase the length of open channel stream by 5 feet. Additionally, approximately 10 feet of stream will be regraded at both the culvert inlet and outfall. The regrade will provide a consistent channel section through the culvert crossing beneath the trail. Replacing the twin culverts under the trail will improve connectivity to approximately 40 feet of upstream habitat between the Interim Use Trail and East Lake Sammamish Parkway, with the potential for access to an additional 17,300 feet of habitat upstream of East Lake Sammamish Parkway.

#### Stream 0143L (Sta. 464+28)

The existing culvert that conveys Stream 0143L under the trail is a 34-foot-long, 36-inch-diameter concrete pipe. On the east side of the trail, water flows north in an open channel for approximately 320 feet at an average slope of 3 percent, before turning west and entering the existing concrete culvert. The existing culvert slope is approximately 6.9 percent, and the open channel downstream of the culvert averages 10 percent for approximately 50 feet before entering the lake.

The bankfull width of Stream 0143L is approximately 6 feet and the proposed box culvert will be 10 feet wide by 7 feet tall. The culvert bed will be countersunk, and the streambed slope will be approximately 5.9 percent.

The proposed fish passage box culvert will be 19 feet long. Approximately 9 feet of channel will be opened on the east side and approximately 5 feet of channel will be opened on the west side. Replacement of the existing culvert will improve connectivity to approximately 360 feet of upstream habitat between the Interim Use Trail and East Lake Sammamish Parkway, with the potential for access to an additional 1,750 feet of habitat upstream of East Lake Sammamish Parkway.

## 4.2.2 Permanent Stream Buffer Impacts

In addition to effects on stream channels, the trail improvements will result in a permanent loss of stream buffers. Similar to permanent impacts on wetland buffers, permanent impacts on stream buffers occur when there is a permanent loss of stream buffer area, typically as a result of paving or permanent clearing. Construction activities that will result in permanent stream buffer impacts include trail widening, driveway reconfigurations, stair replacement, culvert replacements, and stormwater drainage features.

The project will permanently affect portions of 10 stream buffers (see Table 4-2). Approximately 0.21 acre of stream buffer will be eliminated as a result of trail widening and realignment. Impacts on buffers of each individual stream will be 0.05 acre or less. The majority of the stream buffers to be affected by the project are narrow linear swathes immediately adjacent to the Interim Use Trail vegetated with herbaceous species that are currently disturbed by routine trail maintenance activities, landscaped plants associated with adjacent residences, Himalayan blackberry, and native trees and shrubs. Minimal effects on stream buffer functions are anticipated.

## 4.2.3 Temporary Stream Buffer Impacts

The buffers of 11 streams will be temporarily affected during construction. In total, construction will temporarily affect 0.41 acre of stream buffer (see Table 4-2). Temporary impacts on stream buffers consist of minor clearing and grading outside of the trail footprint and around culvert replacement sites to enable project construction. These construction work areas have been conservatively estimated for this project. Once construction is complete, regrowth is expected relatively quickly from the seeds, roots, tubers, stems, and other propagules in the soil under the temporary impact areas. The majority of the stream buffers to be cleared and graded are primarily vegetated with herbaceous species that are currently disturbed by routine trail maintenance activities, landscaped plants associated with adjacent residences, Himalayan blackberry, and native trees and shrubs. Temporarily disturbed buffers will be restored by reseeding or replanting with appropriate native species when construction activities are completed.

## 4.3 Lake Sammamish

Lake Sammamish is outside the project area and will not be permanently or temporarily affected by construction of the proposed trail. However, some permanent and temporary impacts on the outermost portion of the 50-foot shoreline setback are unavoidable (see Appendix D). Wetland buffers, stream buffers, and the shoreline setback often overlap in the project area. Where overlap occurs, impacts are prioritized by wetland buffer, stream buffer, and then shoreline setback. Only impacts on areas that are defined solely as shoreline setback are reported in this section.

### 4.3.1 Shoreline Setback Impacts

The proposed trail crosses the shoreline setback in a few locations, permanently clearing 0.09 acre (4,115 square feet). An additional 0.17 acre (7,372 square feet) will be temporarily cleared or graded outside of the trail footprint for construction. Temporarily disturbed shoreline setback areas will be restored by reseeding or replanting with appropriate native species when construction activities are completed.

## 4.4 Fish and Wildlife Conservation Areas

In accordance with the SMP as described in Section 3.5, impacts to fish and wildlife conservation areas that fall within wetlands, streams, or lakes are described in Sections 4.1, 4.2, and 4.3 above.

In December 2016, after the CAS was completed, the USFWS established new rules and procedures for obtaining permits for the incidental take of bald eagles due to disturbance near nest sites. The County will review the permit requirements and apply for a permit and consult with USFWS if necessary. Also in December 2016, the Washington Fish and Wildlife Commission removed the bald eagle from the list of state sensitive species (WAC 232-12-011). As a result, bald eagles are no longer among the species for which FWHCAs are established in the City of Sammamish, per SMC 21A.15.468.

Management guidelines developed by USFWS (2007) are intended to help minimize impacts to bald eagles, including impacts that constitute disturbance. Recommended measures for minimizing the risk of disturbance include (1) keeping a distance between the activity and the nest (disturbance buffers), (2) maintaining preferably forested (or natural) areas between the activity and around nest trees (landscape buffers), and (3) avoiding certain activities within 660 feet of bald eagle nests during the breeding season (typically January 1 through August 15 in Washington State).

King County does not expect trail construction activities within 660 feet of the bald eagle nest to result in substantial disturbance to bald eagles based on current surrounding land uses and activities. The nest is surrounded by residential development with approximately 4 single-family dwellings within 330 feet, and approximately 24 single-family dwellings (7 of which are on the Lake Sammamish waterfront) within 660 feet. Activities associated with the residences include yard and house maintenance (e.g., lawn mowing, leaf blowing), as well as social gatherings and recreational activities. East Lake Sammamish Parkway and local neighborhood roads with vehicular and bicycle traffic are also within the 330-foot and 660-foot distances, and pedestrians and bicyclists currently use the Interim Use Trail.

Typical construction activities that will occur within 660 feet of the nest include site preparation and temporary erosion and sedimentation control installation, clearing and grubbing, and removals; drainage structure replacement; earthwork; trail and driveway crushed surfacing and paving; and finishing work (planting, striping, signing, fencing). Work that generates levels of noise and human activity substantially greater than current conditions will be conducted outside of the bald eagle breeding season (January 1 through August 15) to the extent practicable. Measures implemented to minimize noise to adjacent residents are also expected to avoid or minimize the risk of disturbance to bald eagles. Where practical, native evergreen vegetation will be incorporated into the landscape plan for year-round screening within 660 feet of the nest.

Tree clearing for trail construction may reduce the availability of trees used for nesting or foraging by pileated woodpeckers. The project is consistent with WDFW management recommendations for pileated woodpecker habitat, however. By following the existing cleared area of the rail corridor, trail construction will not result in any new disturbance in large forest patches. Forested areas with the greatest potential to support breeding territories of pileated woodpeckers are upslope of the project area, away from the trail.

In addition, most trees larger than 24 inches diameter at breast height (dbh) will be retained. Almost 900 trees were assessed for the tree preservation study for this project. Approximately 190 of those are larger than 24 inches dbh. Of those, only 38 (20 percent) will need to be removed for trail construction. At the northern end of the project area, where pileated woodpecker habitat is most prevalent, only 4 trees larger than 24 inches dbh will be removed.

## 4.5 Critical Aquifer Recharge Areas

The city code provides groundwater quality and quantity protection standards for development within CARAs (SMC 21A.50.280). The new trail surface will be non-pollution generating impervious surface; therefore, water quality treatment facilities are not required. Although the project proposes driveway reconfigurations, there are no target areas within the project requiring water quality treatment (Parametrix 2016). More than 50 threshold discharge areas<sup>5</sup> (TDAs) were identified within the project area (Parametrix 2016). Project TDAs are delineated in three ways: areas that runoff directly to the lake via overland flow or manmade conveyance, areas that runoff directly to streams that cross the trail and flow into Lake Sammamish, and areas that runoff to adjacent private property landscaping. The trail has qualified for an exemption for the flow control facilities in 50 of the 56 TDAs (Parametrix 2016). Of the six remaining TDAs, five meet the direct discharge exemption requirements to Lake Sammamish, and an infiltration facility will be used to meet flow control requirements in one (Parametrix 2016).

The trail has qualified for an exception from the flow control facilities and flow control best management practice (BMP) requirements (Parametrix 2016). While there are no flow control facilities proposed for the project, infiltration trenches are proposed in a few areas to infiltrate runoff from the trail. There are no target areas within the project requiring water quality treatment (Parametrix 2016). The new trail surface will be non-pollution generating impervious surface; therefore, water quality treatment facilities are not required. No impacts to critical aquifer recharge areas will occur as a result of the project.

---

<sup>5</sup> Threshold discharge area is defined as an on-site area draining to a single natural discharge location, or to multiple natural discharge locations that combine within one-quarter mile downstream, as determined by the shortest flowpath (SMC 24.06.040).

## 5. MITIGATION APPROACH

This section describes the sequencing approach used for mitigating project impacts. The mitigation sequencing approach is based on a hierarchy of avoiding and minimizing adverse impacts through careful design, rectifying temporary impacts, and compensating for unavoidable adverse impacts (Ecology et al. 2006). Permanent and temporary impacts on wetlands, wetland buffers, streams, stream buffers, and the Lake Sammamish shoreline setback are shown in Appendix D. Mitigation for project impacts is shown in Appendix E.

### 5.1 Avoidance and Minimization

The avoidance and minimization of critical area impacts was a guiding principle in the preliminary design of this project. It started with the general alignment of the trail. King County worked diligently to avoid and minimize permanently affecting wetlands and streams. Design refinements were also considered and incorporated, where feasible, to reduce the potential loss of existing wetland and stream habitat. The design incorporates the following design strategies to avoid and minimize critical area and buffer impacts:

- **Utilize an alignment that follows the existing Interim Use Trail.** The alignment is also the location of a former railbed. With this alignment, most wetlands will be avoided and buffer and shoreline setback impacts will be limited to the area needed to widen the existing trail.
- **Apply the narrowest typical trail section when adjacent to critical areas.** In the environmental documentation for the proposed trail, King County envisioned a trail as wide as 27 feet in some areas, which incorporated a separate soft-surface trail for pedestrian use. Based on the amount of impacts that resulted from this configuration and subsequent discussions with the City of Sammamish, King County has narrowed the proposed width of the trail to 18 feet (the narrowest typical section) throughout Sammamish. This includes 12 feet of pavement, two 2-foot shoulders, and two 1-foot clear zones.
- **Use retaining walls to narrow the trail section where critical areas are adjacent or crossed.** This includes adding 27 retaining walls for a total of 7,784 linear feet adjacent to wetlands, streams, and buffers.
- **Shift alignments away from critical areas.** Throughout Sammamish, the proposed configuration of the trail encompasses the existing gravel trail. Slight shifts in the center line and adjustments to the profile were closely examined and incorporated, where practicable, to minimize critical area impacts.
- **Reduce potential for human intrusion through the use of fencing and signage.** King County typically uses split-rail fence between the trail and an adjacent critical area, unless an edge hazard warrants a different kind of fence (e.g., chain link).

In addition, BMPs will be implemented to avoid or reduce adverse impacts on critical areas during construction. BMPs will be implemented for pollution control, erosion control, and stormwater management. Measures used may include mulching, matting, and netting; filter fabric fencing; quarry rock entrance mats; sediment traps and ponds; and surface water interceptor swales and ditches. Significant water quality impacts are not expected if erosion control BMPs, stormwater, and spill containment measures are properly implemented, monitored, and maintained during construction. A temporary erosion and sedimentation control plan and construction stormwater pollution prevention plan will be implemented to minimize and control pollution and erosion from stormwater.

## 5.2 Restoration of Temporary Impacts

Temporary impacts on wetlands (0.59 acre), wetland buffers (2.46 acres), stream (<0.01 acre), stream buffers (0.41 acre), and the shoreline setback (0.17 acre) will be restored on site at the affected locations along the project corridor after construction. These temporarily disturbed areas will be reseeded or replanted with appropriate native species when construction activities are completed. Temporary impacts on stream channels will be regraded and substrate will be restored with gravel and rounded cobble.

## 5.3 Compensatory Mitigation

Even with the implementation of the avoidance and minimization effort above, permanent impacts on wetlands, streams, wetland buffers, stream buffers, and the Lake Sammamish shoreline setback are unavoidable. King County will replace the area and functions lost through compensatory mitigation. Mitigation areas are shown on the plans in Appendix E.

### 5.3.1 Summary of Proposed Mitigation

King County is proposing to complete compensatory mitigation at a total of 26 sites in the Master Plan Trail right-of-way (Table 5-1; Appendix E). The proposed mitigation will include a minimum of 0.22 acre of wetland creation/restoration credits at an off-site mitigation bank, 0.65 acre of wetland enhancement, 1.53 acres of wetland buffer addition, 0.77 acre of wetland buffer enhancement, 0.24 acre of stream buffer enhancement, and 0.09 acre of shoreline setback enhancement.

Generally, the proposed mitigation sites are currently dominated by invasive species (e.g., Himalayan blackberry, reed canarygrass, and Scotch broom) and maintained lawn or yard with small structures, but are devoid of native trees and shrubs. The proposed compensatory mitigation will include removing invasive vegetation, lawn, landscaped yard, and structures; tilling and amending soil; adding mulch; and planting native vegetation. Deciduous and coniferous tree species and shrubs will be planted to increase plant diversity, increase vegetation complexity, offer visual and aural screening, improve fish and wildlife habitat, and provide shade, leaf litter, future snags, and woody debris. Habitat features (including habitat logs and brush piles) will be added to the mitigation areas. Existing desirable vegetation will be protected where feasible. Fencing will be installed and maintained along the trail adjacent to all mitigation areas to minimize intrusion and disturbance.

**Table 5-1. Proposed Mitigation Locations and Type**

Station	Wetland/Stream Name	Wetland Creation/ Restoration (Acres <sup>a</sup> )	Wetland Enhancement (Acres)	Wetland Buffer Addition Area (Acres)	Wetland Buffer Enhancement (Acres)	Stream Buffer Enhancement (Acres)	Culvert Replacement	Shoreline Setback Enhancement (Acres)
329+00 to 333+50	Wetland 18C			0.27	0.18			
339+25 to 342+25	Shoreline Setback							0.03
365+50 to 366+00	Wetland 22AB		0.05					
367+00 to 371+50	Wetland 22CD		0.07	0.01	0.24			
367+50 to 367+75	Unnamed Stream 7					0.03		
371+75 to 374+75	Wetland 23A			0.15				
373+00 to 374+75	Shoreline Setback							0.04
373+00 to 374+75	Wetland 23B		0.03					0.01
374+75 to 378+75	Wetland 23C		0.08	0.16	0.09			
379+14	Pine Lake Creek						Y	
379+25 to 380+25	Wetland 24B		0.03		0.03			
383+75 to 384+75	Wetland 24B		0.05					
385+50 to 391+75	Wetland 24C							
396+50 to 400+00	Wetland 25A			0.27	0.04			
401+75	Stream 0155						Y	
403+50 to 405+75	Wetland 25B		0.14		0.02			
410+50 to 413+25	Ebright Creek					0.19	Y	
418+75 to 422+25	Wetland 26A		0.09	0.15	0.04			
423+00 to 424+00	Wetland 26C		0.02		<0.01			
424+00 to 424+75	Zackuse Creek					0.02	Y	
424+75 to 426+25	Wetland 26A		0.08					
434+25 to 438+75	Wetland 28B		0.01	0.30	0.09			
441+40	George Davis Creek						Y	
464+28	Stream 0143L						Y	
462+50 to 465+75	Shoreline Setback							0.01
465+70 to 468+00	Wetland 29D			0.22				
	<b>TOTAL</b>	<b>0.22<sup>a</sup></b>	<b>0.65</b>	<b>1.53</b>	<b>0.75</b>	<b>0.24</b>		<b>0.09</b>

<sup>a</sup> Off-site at mitigation bank

## 5.3.2 Wetlands, Wetland Buffers, Stream Buffers, and Shoreline Setback

### 5.3.2.1 Wetland Regulatory Requirements

The City of Sammamish requires compensatory mitigation for alteration to wetlands to achieve equivalent or greater biological functions, as well as a no net loss of area (SMC 21A.50.310). Mitigation actions shall also provide equivalent or greater functions and values compared to conditions existing prior to the proposed alteration. Wetland compensatory mitigation may consist of wetland reestablishment or creation, rehabilitation, or reestablishment or creation and enhancement. To determine the area required for wetland compensatory mitigation, project staff reviewed and compared the regulatory requirements of the City of Sammamish critical areas regulations (SMC 21A.50) and the



guidelines established in Wetland Mitigation in Washington State (Ecology et al. 2006). Tables 5-2 and 5-3 show the recommended mitigation ratios for Category III and IV wetlands as established in those two documents.

The proposed mitigation type for this project is a combination of wetland reestablishment or creation and enhancement. The City of Sammamish and Ecology have similar ratios for this type, except the enhancement component ratio is 4:1 for Category III wetlands under Ecology, and 2:1 under the City requirements. King County will apply the most stringent mitigation ratios (Ecology's) to compensate for wetland loss. The results of applying the recommended mitigation ratios are shown in Table 5-4. King County will provide a minimum of 0.22-acre wetland reestablishment or creation credits (off-site) and 0.65-acre wetland enhancement (on-site).

**Table 5-2. City of Sammamish Wetland Mitigation Ratios <sup>a</sup>**

Category and Type of Wetland	Wetland Reestablishment or Creation	Wetland Rehabilitation	Wetland Reestablishment or Creation (R/C) and Enhancement (E)
Category III	2:1	4:1	1:1 R/C and 2:1 E
Category IV	1.5:1	3:1	1:1 R/C and 2:1 E

<sup>a</sup> SMC 21A.50.310

**Table 5-3. Ecology-Recommended Wetland Mitigation Ratios for Projects in Western Washington <sup>a</sup>**

Category of Wetland Impacts	Wetland Reestablishment or Creation	Wetland Rehabilitation Only	Wetland Reestablishment or Creation (R/C) and Rehabilitation (RH)	Reestablishment or Creation (R/C) and Enhancement (E)	Enhancement Only
Category III	2:1	4:1	1:1 R/C and 2:1 RH	1:1 R/C and 4:1 E	8:1
Category IV	1.5:1	3:1	1:1 R/C and 1:1 RH	1:1 R/C and 2:1 E	6:1

<sup>a</sup> Ecology et al. (2006).

**Table 5-4. Wetland Mitigation Area Required Applying the Ecology-Recommended Mitigation Ratios for Projects in Western Washington for Reestablishment or Creation and Enhancement <sup>a</sup>**

Wetland Category	Impact (SF)	Reestablishment or Creation		Enhancement	
		Mitigation Ratio	Mitigation Area (SF)	Mitigation Ratio	Mitigation Area (SF)
Category III	4,462	1:1	4,462	4:1	17,848
Category IV	4,918	1:1	4,918	2:1	9,936
<b>Total</b>	<b>9,380</b>		<b>9,380</b> <b>(0.22 acre)</b>		<b>27,784</b> <b>(0.64 acre)</b>

### 5.3.2.2 Wetland Buffer Regulatory Requirements

The City of Sammamish requires compensatory mitigation for alteration to wetland buffers to achieve equivalent or greater biological functions, as well as a no net loss of area (SMC 21A.50.310). Mitigation actions shall also provide equivalent or greater functions and values compared to conditions existing prior to the proposed alteration. King County is proposing a minimum 1:1 mitigation ratio for permanent loss of wetland buffers by increasing the buffer around one wetland and enhancing this area where feasible. For this project, King County will add a minimum of 1.53 acres of wetland buffer.

### 5.3.2.3 Site Selection

The City of Sammamish has a preference that mitigation actions shall be in-kind and conducted within the same subbasin and on the same site as the alteration. The right-of-way consists of a long, linear corridor that abuts small portions of several wetlands and wetland buffers; the possibility was considered that mitigation areas in the trail corridor would be small and fragmented. However, the project team was able to identify on-site mitigation areas with available acreage and the opportunity to increase the ecological benefits at 16 wetland and wetland buffer locations in the corridor (Table 5-1, Appendix E).

Sites adjacent to the trail also offer easy access for both construction and maintenance with minimal disturbance to other habitats. King County Parks has a formal maintenance program for all its trail projects. The program is directed at maintaining the trail corridors for recreational and aesthetic uses but it also includes many mitigation projects. The County understands that regular maintenance is necessary to achieve its mitigation commitments in public trail corridors. King County has successfully managed a large number of mitigation sites to achieve mitigation goals and standards.

On-site areas will provide an opportunity for visual and aural screening of the East Lake Sammamish Parkway for both wildlife and trail users. Specific mitigation areas are discussed in the following section.

### 5.3.2.4 Proposed Wetland Mitigation

King County is proposing compensatory mitigation for permanent wetland impacts at an approved mitigation bank. Mitigation credits will be secured to offset the loss of 0.22 acre of wetland in the trail corridor. Although there are four sites suitable for creating wetlands in the corridor (CAS October 2016) and providing some of the desired wetland functions, the ability for these created wetlands to provide habitat functions is limited by buffer availability. At these four sites, wetland buffers would have ranged from 5 feet to the trail to 25 feet to the East Lake Sammamish Parkway.

Wetland mitigation will also include enhancing 0.65 acre of existing wetlands at 11 sites in the trail corridor. Wetland enhancement areas will be planted with trees and shrubs adapted to wetland conditions.

Wetland buffer mitigation will include adding 1.53 acres of upland to existing wetland buffers and enhancing 0.75 acre of existing wetland buffer. In all buffer areas, invasive species will be removed and subsequently planted with native tree and shrub species. Landscape plans showing these areas are presented in Appendix E.

## 5.3.3 Streams

### 5.3.3.1 Regulatory Requirements

The City of Sammamish requires compensatory mitigation for alteration to streams in order to achieve equivalent or greater functions (SMC 21A.50.350).

### 5.3.3.2 Site Selection

The City of Sammamish has a preference that mitigation actions shall be in-kind and conducted within the same subbasin and on the same site as the alteration. Culvert replacement and stream regrading will occur on site as described in Section 4.2.1.

### 5.3.3.3 Proposed Stream Mitigation

King County is proposing a 1:1.15 mitigation ratio for impacts on stream buffers by applying enhancement. King County will provide a minimum of 0.24-acre stream buffer enhancement.

The project proposes to replace culverts on six streams (all of which are Type F) at six trail crossings, resulting in a net improvement to stream function and habitat. Additionally, two more culvert crossings will be replaced west of the trail. The additional culvert replacement sites are at the downstream road crossing (East Lake Sammamish Shore Lane SE) of Pine Lake Creek and the downstream road crossing (East Lake Sammamish Shore Lane NE) of Zackuse Creek. All but one of the new culverts will be wider and shorter than the existing culverts, resulting in a net gain of 69 linear feet (681 square feet) of open channel in the project area. Unnamed Streams 7, 8 (South Fork), and 13, all classified as Type F, are the only streams where a net loss of open channel will occur (24 linear feet [114 square feet] for the three streams combined). All Type F stream culvert replacements are designed to fish passage standards.

Replacement of the culverts at the six trail crossings will improve connectivity to approximately 660 feet of upstream habitat between the Interim Use Trail and East Lake Sammamish Parkway, with the potential for access to an additional 46,450 feet of habitat upstream of East Lake Sammamish Parkway. Replacement of the culverts on Pine Lake Creek and Zackuse Creek under East Lake Sammamish Shore Lane will improve connectivity to approximately 200 feet of habitat between Lake Sammamish and the trail crossings on those two streams. The culvert replacements are described in Section 4.2.1.

## 5.3.4 Review of Best Available Science

The City's current Environmental Critical Areas regulations are based on best available science (BAS). By complying with those regulations, the proposed mitigation plan for the ELST project is consistent with BAS.

Ordinance O2016-410 (ECA Amendments to SMP, Amendments to SMC Title 21A.50), approved by the Sammamish City Council on June 7, 2016, determined that the City's Environmental Critical Areas regulations, as amended, "provide protection for critical areas consistent with BAS" and "were developed through a review of the BAS literature," and that the City had followed requirements established in the Growth Management Act for "including and considering BAS in modification of the regulations for critical areas." The mitigation requirements incorporated into the City's Environmental Critical Areas regulations are thus supported by best available science, as required under SMC 21A.50.145(4). By complying with those requirements, the CAS is consistent with BAS.

The CAS complies with the impact avoidance, minimization, and mitigation requirements in the City's Environmental Critical Areas regulations by following the mitigation sequencing approach established in SMC 21A.50.135 and SMC 25.06.020. King County employed a rigorous approach to avoiding and minimizing impacts to critical areas in a manner consistent with the purpose, effectiveness, engineering feasibility, safety, and cost of the project.

Consistent with the requirements of SMC 21A.50.135 and SMC 21A.50.310, King County is compensating for unavoidable impacts by enhancing critical areas and their buffers and by creating replacement critical areas and buffers, thereby achieving no net loss of critical areas and their functions and values. By meeting or exceeding the impact mitigation ratios in SMC 21A.50.310, the project is consistent with the BAS approach for ensuring no net loss of ecological functions and values.

### 5.3.5 Shoreline Zone Mitigation

Similar to the City of Sammamish Environmentally Critical Areas Regulations, the City's SMP also applies the concept of no net loss of ecological functions (SMC 25.02.010(58)). King County is proposing a 1:1 mitigation ratio for impacts to the shoreline setback by applying enhancement. King County will provide a 0.09-acre shoreline setback enhancement.

The CAS demonstrates the project's compliance with the requirements of the City's Environmental Critical Areas regulations. The CAS is neither required nor intended to address all ecological functions of the shoreline environment; rather, the focus of the CAS is on critical areas. As stated in Sammamish Municipal Code (SMC) Section 21A.25.01, "The SMA [Shoreline Management Act] guidelines require that an SMP [Shoreline Master Program] result in "no net loss" of shoreline ecological functions. This SMP accomplishes that requirement through its goals, policies, and regulations noted above providing restoration program and enhancement incentives to offset the cumulative impacts of new shoreline uses and developments over time." " By complying with the City's development regulations, the East Lake Sammamish Trail will result in no net loss of shoreline ecological functions. No additional mitigation specific to shoreline ecological functions is described in this CAS.

### 5.3.6 Fish and Wildlife Habitat Conservation Areas Mitigation

The project has added high quality upland forest to already designated critical areas buffers near STA 462+50 to 465+75. In total, potential pileated woodpecker habitat has been protected in the form of designated wetland, wetland buffer, or stream buffer in the north end of the project from approximately STA 457 to 468. Only one private driveway and a set of stairs cross this block of habitat.

## 5.4 Mitigation Goals, Objectives, and Performance Standards

The overall goal of the mitigation effort is to replace the habitats and functions lost as a result of the project. The proposed mitigation will accomplish this by enhancing 0.65 acre of wetland, increasing the buffer of 8 wetlands by 1.53 acres, enhancing 0.75 acre of wetland buffer, enhancing 0.24 acre of stream buffer, replacing 8 fish barrier culverts on 6 Type F streams with pipes that are fish passable, and enhancing 0.09 acre of shoreline setback. In addition, mitigation for 0.22 acre of permanent wetland impacts will occur at an off-site approved mitigation bank, and thus, this mitigation will not be carried forward in the following sections. Specific goals and objectives formulated to achieve this result are presented below.

## 5.4.1 Mitigation Goals

The mitigation goals are:

- Enhance 0.65 acre of wetland.
- Increase and enhance the buffer of 8 wetlands by 1.53 acres.
- Enhance 0.75 acre of wetland buffer.
- Enhance 0.24 acre of stream buffer.
- Replace 8 fish barrier culverts on 6 Type F streams with fish passable culverts.
- Enhance 0.09 acre of shoreline setback.

Achievement of these goals is expected to provide the following improvements to wetland, stream, wetland buffer, stream buffer, and shoreline setback functions:

- Provide additional fish habitat by removing fish barriers, increasing open stream channel, and opening up available upstream habitat.
- Increase the production of organic matter by planting trees and shrubs in the created/restored wetland, enhanced wetland, increased wetland buffer, enhanced wetland buffer, enhanced stream buffer, and enhanced shoreline setback.
- Increase fish and wildlife habitat and improve biological diversity by planting with a variety of native wetland and buffer plant species and installing habitat features (habitat logs and brush piles).

## 5.4.2 Mitigation Objectives and Performance Standards

### 5.4.2.1 Wetlands

**Objective 1: Enhance by planting native species a minimum of 0.65-acre forested and scrub-shrub wetland at the enhanced wetland areas.**

**Performance Standards:**

Year 1	Survival of planted woody species in enhanced wetland areas will be at least 80 percent.
Year 2	Record percent cover of native woody species in enhanced wetland area to establish a baseline for areal cover.
Year 3	Native woody species will achieve a minimum of 25 percent areal cover, including desirable native volunteers, in the enhanced wetland areas.
Year 5	Native woody species will achieve a minimum of 50 percent areal cover, including desirable native volunteers, in the enhanced wetland areas.
Year 7	Native woody species will achieve a minimum of 70 percent areal cover in the enhanced wetland areas.
Year 10	Native woody species will achieve a minimum of 80 percent areal cover in the enhanced wetland area.

## 5.4.2.2 Streams

### *Instream Habitat*

**Objective 2:** Replace existing fish barrier culvert at the (six) trail crossings on Pine Lake Creek, Stream 0155, Ebright Creek, Zackuse Creek, George Davis Creek, Stream 0143L, and (two) downstream road crossings on Pine Lake Creek and Zackuse Creek with fish passage culvert to open up available upstream habitat.

#### **Performance Standards:**

Year 1, 2, 3, and 5 Constructed habitat elements including the new fish passable culverts, regraded channels, and streambed material will remain in place as constructed at all 8 culvert replacement sites.

## 5.4.2.3 Wetland and Stream Buffers Areas

**Objective 3:** Establish a minimum of 2.28-acre forested and scrub-shrub wetland buffer, and 0.24-acre forested stream buffer at the increased/enhanced wetland buffer and enhanced stream buffer areas.

#### **Performance Standards:**

Year 1 Survival of planted woody species in increased/enhanced wetland buffer and enhanced stream buffer areas will be at least 80 percent.

Year 2 Record percent cover of native woody species in increased/enhanced wetland buffer and enhanced stream buffer areas to establish a baseline for areal cover.

Year 3 Native woody species will achieve a minimum of 25 percent areal cover in the increased/enhanced wetland buffer and enhanced stream buffer areas.

Year 5 Native woody species will achieve a minimum of 50 percent areal cover in the increased/enhanced wetland buffer and enhanced stream buffer setback areas.

Year 7 Native woody species will achieve a minimum of 70 percent areal cover in the increased/enhanced wetland buffer and enhanced stream buffer areas.

Year 10 Native woody species will achieve a minimum of 80 percent areal cover in the increased/enhanced wetland buffer and enhanced stream buffer areas.

## 5.4.2.4 Shoreline Setback Areas

**Objective 3:** Establish a minimum of 0.09-acre forested habitat at the shoreline setback areas.

#### **Performance Standards:**

Year 1 Survival of planted woody species in enhanced shoreline setback areas will be at least 80 percent.

Year 2 Record percent cover of native woody species in enhanced shoreline setback areas to establish a baseline for areal cover.

Year 3 Native woody species will achieve a minimum of 25 percent areal cover in enhanced shoreline setback areas.

- Year 5 Native woody species will achieve a minimum of 50 percent areal cover in enhanced shoreline setback areas.
- Year 7 Native woody species will achieve a minimum of 70 percent areal cover in enhanced shoreline setback areas.
- Year 10 Native woody species will achieve a minimum of 80 percent areal cover in enhanced shoreline setback areas.

#### 5.4.2.5 Invasive Species

**Objective 4: Limit invasive non-native species throughout the mitigation site planting areas.**

**Performance Standards:**

- Year 1, 2, 3, 5, 7, and 10 Himalayan blackberry, cutleaf blackberry, Scotch broom, English ivy, reed canarygrass, and hedge false bindweed will not exceed 20 percent areal cover in all planting areas.
- Year 3 100 percent removal of Japanese knotweed by Year 3 in the Wetland 22CD buffer enhancement area.

#### 5.4.2.6 Wildlife Habitat

**Objective 5: Provide wildlife habitat.**

**Performance Standards:**

- Year 1, 2, 3, 5, 7, and 10 Increase in areal cover of native woody species in all mitigation areas, as measured in Objectives 1, 2, and 3, to be used as a surrogate to indicate increasing habitat functions.
- Year 1, 3, 5, 7, and 10 Increase in species richness of native species over preexisting conditions in all mitigation areas, as measured in Objectives 1, 2, and 3, to be used as a surrogate to indicate increased habitat functions.
- Year 1, 2, 3, 5, 7, and 10 Installed habitat features are present and functional.

#### 5.4.2.7 Anthropogenic Disturbance

**Objective 6: Protect the mitigation sites from anthropogenic disturbance.**

**Performance Standards:**

- Year 1 through 10 Conduct qualitative monitoring to assess the status of the sites yearly during the 10-year monitoring period to monitor for human disturbance, including but not limited to filling, trash, and vandalism.
- Year 1 through 10 Install and maintain fences and appropriate signs along the trail adjacent to each site to identify their protected status.

## 5.5 Record Drawings

Record drawings and/or a report documenting the as-built or installed conditions will be prepared after construction and plantings are complete. The report will include the following components: (1) drawings that clearly identify the boundaries of the mitigation areas; (2) locations of the sampling and monitoring sites (including photo-point locations); (3) locations of hydrology monitoring stations; (4) photographs of the mitigation sites; and (5) an analysis of any changes to the mitigation plan that occurred during construction. A copy of the as-built report will be sent to the City and USACE within 60 days of completion of construction and planting.

## 5.6 Monitoring

The mitigation areas will be monitored during and after construction. During construction, monitoring will ensure that the BMPs are observed to minimize impacts, and the on-site construction work (including grading and planting) will be coordinated to ensure that the sites are constructed as designed.

After construction is completed, long-term monitoring will be performed annually to ensure that the goals and objectives of the mitigation are being met. Monitoring of the mitigation areas will be performed over a 10-year period by a qualified professional (SMC 21A.50.145; 21A.50.300). A combination of quantitative and qualitative monitoring activities will be used to assess the management objectives and associated performance standards described in the mitigation plan. Activities will include site visits to monitor unnatural site disturbance, photographs to document site development, and data collection for the quantitative evaluation of performance standards. The results of the monitoring will be submitted to the permitting agencies.

Appropriate contingency measures will be developed, as needed, by a qualified professional to ensure that the sites develop healthy vegetation that meets the obligations described in this mitigation plan and the associated permits.

### 5.6.1 Quantitative Monitoring

The following bulleted items describe the methods to be used for the quantitative monitoring, monitoring schedule, and report deadlines.

- The planting sites will be assessed by an appropriate quantitative vegetative field assessment methodology. The line intercept method will be used for determining percent areal cover for woody and invasive species. Plant richness will be determined by a count of native tree and shrub species.
- Quantitative vegetation assessments will follow the same method in each consecutive monitoring year.
- Quantitative vegetation assessments will be performed between June 15 and September 15 of each monitoring year.
- Monitoring reports will be sent to agencies requiring monitoring reports by February 15 of the following year.
- Permanent photographic stations will be established to monitor the development of the sites. Photographs will be taken along transect lines and from vantage points that capture the general mitigation area. All photographs will be labeled to identify locations.



## 5.6.2 Qualitative Monitoring

Qualitative monitoring will be conducted as follows:

- A qualified professional will qualitatively assess the constructed habitat elements including the new fish passable culverts, regraded channels, and streambed material for the first 3 years.
- Qualitative assessment will be performed yearly to visually assess the health of plants and identify areas that may need control of non-native invasive species or other maintenance activities.
- During all qualitative monitoring years, photographic documentation of the sites will occur from permanent photograph stations.

## 5.7 Maintenance

The proposed mitigation is intended to achieve the performance standards with minimal ongoing maintenance. However, King County will manage and maintain the site for 10 years, or until all performance standards are met and the site is closed with the approval of permitting agencies.

As mentioned previously, King County Parks has a formal maintenance program for its trail mitigation projects. The County understands that regular maintenance is necessary to achieve its mitigation commitments in public trail corridors.

Planted vegetation species are adapted to varying site conditions in the Puget Sound lowland, although supplemental irrigation may be needed during the first two growing seasons after installation to ensure the long-term survival of the plants. The need for irrigation will be evaluated based on the conditions observed during the establishment period.

To ensure rapid establishment of the plant community, trees and shrubs will be planted closer together than would generally occur in natural mature stands. Some natural mortality is expected to occur during the monitoring period. All dead and downed woody material will be left in place to provide microhabitats for wildlife. Plants will be replaced as needed to meet performance standards.

Maintenance to control nuisance species in the mitigation areas will likely be necessary. During the monitoring period, if it becomes evident that invasive species are impeding establishment of desirable native plants, measures will be implemented to control nuisance species. A progressively aggressive approach will be used to control nuisance species. Control measures will first include hand cutting and/or grubbing and removal; if this fails, an environmentally sensitive herbicide (e.g., Rodeo or equivalent) may be applied.

## 5.8 Contingency Measures

Adaptive management is driven by the monitoring results and the performance standards. If the performance standards are not met, adaptive management activities will be implemented to achieve the desired condition. Management activities may include implementation of contingencies described in Table 5-5, or other appropriate measures. Site conditions will be evaluated to determine the cause of the problem and the most appropriate countermeasure.

Information from the annual monitoring program will be used to identify any maintenance and/or corrective actions. If problems are identified in monitoring, King County biologists will determine the cause of the problem and implement proper maintenance or corrective activities. These activities will be discussed in the annual monitoring report.

## 5.9 Performance Security/Financial Assurance

This mitigation project will be sponsored by King County. The County will implement a suitable mechanism to ensure that the project is implemented successfully and monitored for a minimum of 10 years, or until the project mitigation is deemed a success by achieving its performance standards.

### 5.10 Site Protection

The County owns the property underlying the mitigation sites. They will protect the mitigation sites in perpetuity through a legal mechanism that permits maintenance and monitoring of the mitigation area. This mechanism shall be retained by the County and may be submitted to the USACE after permit issuance, if required. In addition, permanent fencing and/or signs indicating that the area is a natural or sensitive or critical area to be protected from disturbance will be posted along the boundaries of each mitigation area.

**Table 5-5. Contingency Measures for the Mitigation Sites**

Problem	Contingency Measure
Less than 80% of planted woody species survive in Year 1	King County biologists (or other qualified biologist) will assess the sites to determine what conditions are preventing the plants from thriving. Appropriate measures will be taken to correct any conditions that are limiting growth. Plants will be replaced with appropriate native species to achieve the Year 1 standard. Additional measures (such as providing additional protection) will be considered if necessary.
Percent cover for woody species not met during Years 3, 5, or 7	King County biologists (or other qualified biologist) will assess the sites to determine what conditions are preventing the plants from thriving. Appropriate measures, such as increased weed control or extra plantings, will be taken to correct any conditions that are limiting growth.
Invasive species exceed percent cover threshold	Implement/revise invasive species control plan.
Performance standards not met at Year 10	Continue the monitoring regime for 1 additional year. The sites will continue to be evaluated every year until each site has met the stated performance standards associated with management objectives. Other contingency measures may be implemented during this period.

### 5.11 Long-term Management Plan

The mitigation sites are located on King County property. After attainment of performance standards and acceptance of the mitigation project by the USACE, the County will implement a long-term management plan for the sites as part of trail operations, if required.

Site management activities will include noxious weed control, damage repair from vandalism, trash removal, and signage maintenance.

Monitoring reports or technical memoranda will document annual management activities and identify key issues and actions needed for the following year. Reports are anticipated to be submitted every year to the USACE, by the end of the calendar year, for the first 10 years following attainment of performance standards.

The County will issue a letter of assurance to cover long-term management costs of the mitigation site to the USACE ensuring the County’s compliance with the long-term management plan.

**Exhibit 16**  
**SSDP2016-00415**

**000813**<sub>5-13</sub>

## 6. REFERENCES

- Berge, H.B., and K. Higgins. 2003. The current status of kokanee in the greater Lake Washington Watershed. King County Department of Natural Resources and Parks, Water and Land Resources Division, Seattle, Washington.
- Beschta, R.L., R.E. Bilby, G.W. Brown, L.B. Holtby, and T.D. Hofstra. 1987. Stream temperature and aquatic habitat: fisheries and forestry interactions. *In*: E.O. Salo and T.W. Cundy, eds. Streamside management: forestry and fishery interactions. University of Washington, Seattle, Washington.
- Brinson, M.M. 1993. A Hydrogeomorphic Classification for Wetlands. Wetlands Research Program Technical Report WRP-DE-4. U.S. Army Corps of Engineers Waterways Experiment Station, Vicksburg, Mississippi.
- Cowardin, L.M., V. Carter, F.C. Golet, and E.T. LaRoe. 1979. Classification of Wetlands and Deepwater Habitats of the United States. FWS/OBS-70/31, U.S. Fish and Wildlife Service, Washington, D.C.
- Ecology (Washington State Department of Ecology). 1994. East Lake Sammamish Basin—Watershed Management Committee, Basin and Nonpoint Action Plan. Olympia, WA.
- Ecology (Washington State Department of Ecology). 1997. Washington State Wetland Identification and Delineation Manual. Publication #96-94. Olympia, Washington.
- Ecology (Washington State Department of Ecology). 2008. Washington Water Resource Inventory (WRIA) Maps. <http://www.ecy.wa.gov/services/gis/maps/wria/wria.htm>.
- Ecology (Washington State Department of Ecology), U.S. Army Corps of Engineers Seattle District, and U.S. Environmental Protection Agency Region 10. 2006. Wetland Mitigation in Washington State – Part 1: Agency Policies and Guidance (Version 1). Washington State Department of Ecology. Publication #06-06-011a. Olympia, Washington. March 2006.
- Environmental Laboratory. 1987. Corps of Engineers Wetland Delineation Manual. Technical Report Y-87-1, Environmental Laboratory, Department of the Army, Waterways Experiment Station, Vicksburg, Mississippi.
- GretagMacbeth. 2000. Munsell soil color charts. New Windsor, New York.
- Hruby, T. 2004. Washington State Wetland Rating System for Western Washington – Revised. Washington State Department of Ecology. Publication #04-06-025. Olympia, Washington.
- Kerwin, J. 2001. Salmon and Steelhead Habitat Limiting Factors Report for the Cedar-Sammamish Basin (Water Resource Inventory Area 8). September 2001. Washington Conservation Commission. Olympia, Washington.
- King County. 1990. East Lake Sammamish Basin Conditions Report—Preliminary Analysis. King County Department of Public Works, Surface Water Management Division. Seattle, Washington.
- King County. 1994. Final East Lake Sammamish Basin and Nonpoint Action Plan. December 1994. Seattle, Washington.

- King County. 2010. NEPA/SEPA Final Environmental Impact Statement, Volume I, East Lake Sammamish Master Plan Trail. Prepared for Federal Highway Administration, Washington State Department of Transportation, and King County Facilities Management Division. Seattle, Washington. April 2010.
- KCCFM (King County Department of Construction and Facilities Management). 2000. East Lake Sammamish Interim Use Trail and Resource Protection Plan. Draft EIS. Prepared for KCCFM by Parametrix, Inc., Adolfson Associates, Inc., and associated firms.
- Lake Sammamish Kokanee Work Group. 2014. Blueprint for Restoration and Enhancement of Lake Sammamish Kokanee Tributaries. King County, Washington.
- Lichvar, R.W., M. Butterwick, N.C. Melvin, and W.N. Kirchner. 2014. The National Wetland Plant List: 2014 Update of Wetland Ratings. *Phytoneuron* 2014-41:1-42.  
<http://rsgisias.crrel.usace.army.mil/NWPL/>.
- McDade, M.H., F.J. Swanson, W.A. McKee, J.F. Franklin, and J. Van Sickle. 1990. Source distances for coarse woody debris entering small streams in western Oregon and Washington. *Canadian Journal of Forest Research* 20:326-330.
- Null, W.S., G. Skinner, and W. Leonard. 2000. Wetland Functions Characterization Tool for Linear Projects. Washington State Department of Transportation, Environmental Affairs Office, Olympia, Washington.
- Parametrix. 2005. East Lake Sammamish Master Plan Trail Wetland Biology Discipline Report. Prepared for King County Facilities Management Division. Bellevue, Washington. October 2005.
- Parametrix. 2006. East Lake Sammamish Master Plan Trail Fish and Fish Habitat Technical Report. Prepared for King County Facilities Management Division. Bellevue, Washington. October 2006.
- Parametrix. 2007. Draft Biological Assessment for the East Lake Sammamish Trail Master Plan. Prepared for King County Facilities Management Division and Federal Highway Administration. Bellevue, Washington. April 2007.
- Parametrix. 2015. Evaluation of Existing Drainage Structures for Replacement in the South Sammamish Segment. Technical Memorandum from Paul Fendt to King County. Seattle, Washington. February 26, 2015.
- Parametrix. 2016. East Lake Sammamish Master Plan Trail—South Sammamish Segment B. Draft Technical Information Report. Prepared for King County Facilities Management Division. Seattle, Washington. July 2016.
- Pfeifer, B. 1992. Fisheries Investigations of Lakes Washington and Sammamish—1980-1990. Part V. Wild Cutthroat and Kokanee in Lakes Washington and Sammamish (draft document). Wash. Dep. Game. 210p. (Available from West Coast Sockeye Salmon Administrative Record, Environmental and Technical Services Division, National Marine Fisheries Service, 525 N.E. Oregon Street, Portland, OR 97232.)

- R2 Resource Consultants, Inc. 2012. Technical memorandum re: replacement of the three culverts and realignment of approximately 200 feet of stream channel upstream of East Lake Sammamish Parkway. June 18, 2012.
- Sedell, J.R., and R.L. Beschta. 1991. Bringing back the “bio” in bioengineering. *In: Fisheries Bioengineering: Proceedings of a Symposium*. M.D. Bethesda, J. Colt, and S. Dendall, eds. Pgs. 160-175. American Fisheries Society Publication 10. Bethesda, Maryland.
- Snyder, D., P. Gale, and R. Pringle. 1973. Soil Survey of King County Area, Washington. U.S. Department of Agriculture, Soil Conservation Service, Washington, D.C.
- USACE (U.S. Army Corps of Engineers). 2010. Regional Supplement to the Corps of Engineers Wetland Delineation Manual: Western Mountains, Valleys, and Coast Region (Version 2.0). U.S. Army Engineer Research and Development Center Environmental Laboratory. Vicksburg, Mississippi. May 2010.
- USFWS (U.S. Fish and Wildlife Service). 2013. National Wetlands Inventory (NWI), online wetlands mapper. U.S. Department of the Interior, Fish and Wildlife Service, Washington D.C.  
<http://www.fws.gov/wetlands/Data/Mapper.html>.
- USFWS (U.S. Fish and Wildlife Service). 2007. National Bald Eagle Management Guidelines. May 2007. 23 pp.
- The Watershed Company (TWC). 2017. East Lake Sammamish Trail Segment B – Environmental Peer Review. March 2017.
- Vanderhoof, J. 2002. 2001 Volunteer Salmon Watcher Program in the Lake Washington Watershed and Central Puget Sound Drainages. Report prepared for King County Water and Land Resources Division, in cooperation with Lake Washington/Cedar/Sammamish Watershed Forum, Central Puget Sound Forum, King Conservation District, Snohomish County Surface Water Management, Bellevue Stream Team, Cities of Issaquah, Kirkland, Redmond, Renton, Seattle, and Woodinville. June 2002.
- WDFW (Washington Department of Fish and Wildlife). 1998. 1998 Washington State salmonid stock inventory. Appendix: Bull trout and Dolly Varden. Washington Department of Fish and Wildlife, Olympia, Washington.
- WDFW (Washington Department of Fish and Wildlife). 2016a. SalmonScape online mapping tool. Olympia, Washington.
- WDFW (Washington Department of Fish and Wildlife). 2016b. Priority and Habitat Species on the web. Olympia, Washington.
- WDNR (Washington State Department of Natural Resources). 2016. List of Sections that Contain Natural Heritage Features. Data Current as of August 1, 2016. Olympia, Washington.
- White, R.J. 1999. An inspection of salmonid stream crossings on the proposed East Lake Sammamish Trail. Provided in public scoping comments for the EIS. Edmonds, Washington.
- Williams, R.W., R.M. Laramie, and J.J. Ames. 1975. A Catalog of Washington Streams and Salmon Utilization, Volume 1, Puget Sound. Washington Department of Fisheries, Olympia, Washington.

# APPENDIX A

## Wetland Determination Data Forms

Data Plot #: 15A-SP1  
 Wetland: 15A

## WETLAND DETERMINATION (Modified from: 1987 ACOE Wetlands Delineation Manual)

Project/Site: ELST Re-delineation Date: 10/30/2007 Revisited 03-11-14  
 Applicant/Owner: King County County: King County  
 Investigator: Linda Krippner/Michael Muscari State: WA  
 1987 Method  1997 WA St. Method Community ID: PFO/PSS 03-11-14 - PFO  
 Do Normal Circumstances exist on the site? Yes X No \_\_\_\_\_ Field Plot ID: 15A-SP1  
 Is the site significantly disturbed (Atypical Situation)? Yes \_\_\_\_\_ No X  
 Is the area a potential Problem Area? Yes \_\_\_\_\_ No X

**Remarks** (Explain sample location, disturbances, problem areas):  
*This sample plot is located approximately 6' west of flag 15A-3.*

### VEGETATION (✓ Dominant species are checked)

Plant Species	% Cover	Stratum	Indicator
✓ 1. <u>Agrostis spp.</u>	<u>80</u>	<u>Herb</u>	<u>FAC</u>
✓ 2. <u>Equisetum telmateia</u>	<u>40</u>	<u>Herb</u>	<u>FACW</u>
✓ 3. <u>Phalaris arundinacea</u>	<u>30</u>	<u>Herb</u>	<u>FACW</u>
4. <u>Scirpus microcarpus</u>	<u>10</u>	<u>Herb</u>	<u>OBL</u>
✓ 5. <u>Rubus spectabilis</u>	<u>30</u>	<u>Shrub</u>	<u>FAC+</u>
✓ 6. <u>Alnus rubra</u>	<u>30</u>	<u>Tree</u>	<u>FAC</u>
7. <u>Thuja plicata</u>	<u>10</u>	<u>Tree</u>	<u>FAC</u>

### 03-11-14 Observations

Agrostis spp. 40%  
 Equisetum telmateia 40%  
 Phalaris arundinacea 30%  
 Hedera helix 5%  
 Rubus armeniacus 2%  
 Rubus spectabilis 30%  
 Alnus rubra 30%  
 Fraxinus latifolia 5%  
 Thuja plicata 10%  
 moss 60%

Percent of **Dominant Species** that are OBL, FACW, or FAC (except FAC-). Include species noted (\*) as showing morphological adaptations to wetlands. "T" indicates trace. 100

**Remarks** (Describe disturbances, relevant local variations, seasonal effects, etc.):  
*Grasses and shrubs had been mowed. The area is lawn interspersed with shrubs and trees. The percent of dominant species that are hydrophytic is greater than 50 percent. Hydrophytic vegetation criterion is satisfied.*

### HYDROLOGY

#### Recorded Data (Describe in Remarks):

\_\_\_\_\_ Stream, Lake, or Tide Gage  
 \_\_\_\_\_ Aerial Photograph  
 \_\_\_\_\_ Other  
X No Recorded Data Available

#### Wetland Hydrology Indicators (Describe in Remarks):

Primary Indicators:  
 \_\_\_\_\_ Inundated  
X Saturated in Upper 12 inches  
 \_\_\_\_\_ Water Marks  
 \_\_\_\_\_ Drift Lines  
 \_\_\_\_\_ Sediment Deposits  
 \_\_\_\_\_ Drainage Patterns in Wetlands

#### Field Observations:

Depth of Surface Water: none (in.)  
 Depth to Free Water in Pit: 15 (in.)  
 Depth to Saturated Soil: 6 (in.)

Secondary Indicators (2 or more required):  
 \_\_\_\_\_ Oxidized Rhizospheres in Upper 12 inches  
 \_\_\_\_\_ Water-Stained Leaves  
 \_\_\_\_\_ Local Soil Survey Data  
 \_\_\_\_\_ Other (Explain in Remarks)

**Remarks** (As relevant, describe recent precipitation, hydrologic modifications, local variations, etc.):  
*Water collecting in pit at 15" after 5 min.  
 Soil saturation in the upper 12 inches satisfies wetland hydrology criterion.*

**03-11-14 Observations** - No surface water. Soil saturated at surface. No free water in pit.

# Parametrix

Data Plot #: 15A-SP1  
Wetland: 15A

Project/Site: ELST Re-delineation Date: 10/30/2007 Revised 03-11-14

## SOIL

### Soil Survey Data:

Map Unit Name: Alderwood gravelly sandy loam, 6 to 15 % slopes Drainage Class: Moderately well drained  
Field Observations Confirm Mapped Type?

Taxonomy (Subgroup): Entic Durochrepts Yes  No  NA

### Profile Description:

Depth (Inches)	Horizon Designation	Matrix Color (Munsell Moist)	Mottle Color (Munsell Moist)	Mottle Abundance/Contrast	Texture, Concretions, Rhizospheres, etc.
0-14	O	10YR 2/1	none	none	mucky sand
14-16	A	10YR 3/1	none	none	sandy gravel

### Hydric Soil Indicators:

- |   |   |
|---|---|
| <input type="checkbox"/> Histosol                               | <input type="checkbox"/> Listed on Hydric Soils List      |
| <input type="checkbox"/> Histic Epipedon                        | <input type="checkbox"/> Fe/Mn Concretions                |
| <input type="checkbox"/> Sulfidic Odor                          | <input type="checkbox"/> Organic Streaking in Sandy Soils |
| <input type="checkbox"/> Aquic or Peraguc Moisture Regime       | <input type="checkbox"/> Mottles (Redoximorphic Features) |
| <input type="checkbox"/> Reducing Conditions                    | <input type="checkbox"/> Other (Explain in Remarks)       |
| <input checked="" type="checkbox"/> Gleyed or Low-Chroma Colors |   |
| <input type="checkbox"/> High Organic Content in Surface Layer  |   |

03-11-14 Observations -					
0-14	10YR 2/1 (100%)	none	none	silt loam w. gravel	
14-18	10YR 2/1 (100%)	none	none	silt loam	

Remarks (Describe soil disturbances, local variations, etc.):

**Remarks** - High organic content throughout profile.

*Lots of roots mixed in with 0 layer. Low chroma muck indicates hydric soils.*

## WETLAND DETERMINATION

Hydrophytic Vegetation Present? Yes  No  Is this Sampling Point Within a Wetland?  
Hydric Soils Present? Yes  No  Yes  No   
Wetland Hydrology Present? Yes  No

### Remarks

*Wetland vegetation, hydrology, and soil criteria are met. Therefore, the sample plot is located in a wetland.*



Data Plot #: 15A-SP2  
 Wetland: Upland near 15A

## WETLAND DETERMINATION (Modified from: 1987 ACOE Wetlands Delineation Manual)

Project/Site: ELST Re-delineation Date: 10/30/2007 Revised 03-11-14  
 Applicant/Owner: King County County: King County  
 Investigator: Linda Krippner/Michael Muscari State: WA  
 1987 Method  1977 WA St. Method Community ID: Upland Forest/Herb  
 Do Normal Circumstances exist on the site? Yes X No \_\_\_\_\_ Field Plot ID: 15A-SP2  
 Is the site significantly disturbed (Atypical Situation)? Yes \_\_\_\_\_ No X  
 Is the area a potential Problem Area? Yes \_\_\_\_\_ No X

**Remarks** (Explain sample location, disturbances, problem areas):  
*This sample plot is located several feet northeast of flag 1.*

**03-11-14 Observations** - This sample plot vicinity has been disturbed with clearing, cutting, and landscaping at edge.

### VEGETATION (✓ Dominant species are checked)

Plant Species	% Cover	Stratum	Indicator
✓ 1. <u>Equisetum telmateia</u>	<u>20</u>	<u>Herb</u>	<u>FACW</u>
✓ 2. <u>Phalaris arundinacea</u>	<u>30</u>	<u>Herb</u>	<u>FACW</u>
3. <u>Rubus armeniacus</u>	<u>10</u>	<u>Shrub</u>	<u>FACU</u>
✓ 4. <u>Alnus rubra</u>	<u>20</u>	<u>Tree</u>	<u>FAC</u>

**03-11-14 Observations**  
 Equisetum telmateia 70%  
 Calystegia sepium 15%  
 Oemleria cerasiformis 15%  
 Rubus armeniacus 20%  
 Appears that the Alnus rubra have been cut down. There is a pile of wood in corner of ROW.

Percent of **Dominant Species** that are OBL, FACW, or FAC (except FAC-). Include species noted (\*) as showing morphological adaptations to wetlands. "T" indicates trace. 100

**Remarks** (Describe disturbances, relevant local variations, seasonal effects, etc.):  
*The percent of dominant species that are hydrophytic is greater than 50 percent. Hydrophytic vegetation criterion is satisfied.*

### HYDROLOGY

**Recorded Data** (Describe in Remarks):  
 \_\_\_\_\_ Stream, Lake, or Tide Gage  
 \_\_\_\_\_ Aerial Photograph  
 \_\_\_\_\_ Other  
X No Recorded Data Available

**Wetland Hydrology Indicators** (Describe in Remarks):  
 Primary Indicators:  
 \_\_\_\_\_ Inundated  
 \_\_\_\_\_ Saturated in Upper 12 inches  
 \_\_\_\_\_ Water Marks  
 \_\_\_\_\_ Drift Lines  
 \_\_\_\_\_ Sediment Deposits  
 \_\_\_\_\_ Drainage Patterns in Wetlands

**Field Observations:**

Depth of Surface Water: none (in.)  
 Depth to Free Water in Pit: none (in.)  
 Depth to Saturated Soil: none (in.)

Secondary Indicators (2 or more required):  
 \_\_\_\_\_ Oxidized Rhizospheres in Upper 12 inches  
 \_\_\_\_\_ Water-Stained Leaves  
 \_\_\_\_\_ Local Soil Survey Data  
 \_\_\_\_\_ Other (Explain in Remarks)

**Remarks** (As relevant, describe recent precipitation, hydrologic modifications, local variations, etc.):  
*Soils moist but not saturated. No primary or secondary indicators of hydrology are present. Wetland hydrology criterion is not satisfied.*

# Parametrix

Data Plot #: 15A-SP2  
Wetland: Upland near 15A

Project/Site: ELST Re-delineation Date: 10/30/2007 Revisited 03-11-14

## SOIL

### Soil Survey Data:

Map Unit Name: Alderwood gravelly sandy loam 6 to 15% slopes Drainage Class: Moderately well drained  
Field Observations Confirm Mapped Type?

Taxonomy (Subgroup): Entic Durochrepts Yes  No  NA

### Profile Description:

Depth (Inches)	Horizon Designation	Matrix Color (Munsell Moist)	Mottle Color (Munsell Moist)	Mottle Abundance/Contrast	Texture, Concretions, Rhizospheres, etc.
0-12	A	10YR 2/1	none	none	rock fill sand

**03-11-14 Observations -**  
0-18 10YR 2/1 (100%) none none gravelly sandy loam  
**Remarks -** Edge of fill material/slope.

### Hydric Soil Indicators:

- |   |   |
|---|---|
| <input type="checkbox"/> Histosol                               | <input type="checkbox"/> Listed on Hydric Soils List      |
| <input type="checkbox"/> Histic Epipedon                        | <input type="checkbox"/> Fe/Mn Concretions                |
| <input type="checkbox"/> Sulfidic Odor                          | <input type="checkbox"/> Organic Streaking in Sandy Soils |
| <input type="checkbox"/> Aquic or Peraguc Moisture Regime       | <input type="checkbox"/> Mottles (Redoximorphic Features) |
| <input type="checkbox"/> Reducing Conditions                    | <input type="checkbox"/> Other (Explain in Remarks)       |
| <input checked="" type="checkbox"/> Gleyed or Low-Chroma Colors |   |
| <input type="checkbox"/> High Organic Content in Surface Layer  |   |

**Remarks** (Describe soil disturbances, local variations, etc.):  
*Low chroma soil matrix indicates hydric soil. Fill material exists on the wetland boundary.*

## WETLAND DETERMINATION

Hydrophytic Vegetation Present?	Yes <input checked="" type="checkbox"/> No <input type="checkbox"/>	Is this Sampling Point Within a Wetland? Yes <input type="checkbox"/> No <input checked="" type="checkbox"/>
Hydric Soils Present?	Yes <input checked="" type="checkbox"/> No <input type="checkbox"/>	
Wetland Hydrology Present?	Yes <input type="checkbox"/> No <input checked="" type="checkbox"/>	

**Remarks**  
*Wetland hydrology criterion is not satisfied. Therefore, the sample plot is not located in a wetland.*

Data Plot #: 15C-SP1  
 Wetland: 15C

## WETLAND DETERMINATION (Modified from: 1987 ACOE Wetlands Delineation Manual)

Project/Site: ELST Re-delineation Date: 10/31/2007 Revisited 03-11-14  
 Applicant/Owner: King County County: King  
 Investigator: Chip Maney State: WA

1987 Method  1997 WA St. Method Community ID: PEM/PFO 03-11-14 - PFO  
 Do Normal Circumstances exist on the site? Yes X No \_\_\_\_\_ Field Plot ID: 15C-SP1  
 Is the site significantly disturbed (Atypical Situation)? Yes \_\_\_\_\_ No X  
 Is the area a potential Problem Area? Yes \_\_\_\_\_ No X

**Remarks** (Explain sample location, disturbances, problem areas):

*This plot is located 2 feet east of ~~the ditch~~ and 25 feet north of the end of a laurel hedge, just outside of the red alder canopy. No access to an upland plot exists.*

Unnamed Stream 5

**VEGETATION** (✓ Dominant species are checked)

Plant Species	% Cover	Stratum	Indicator
1. <u>Cardamine oligosperma</u>	<u>trace</u>	<u>H</u>	<u>FAC</u>
2. <u>Carex obnupta</u>	<u>trace</u>	<u>H</u>	<u>OBL</u>
3. <u>Convolvulus spp.</u>	<u>trace</u>	<u>H</u>	<u></u>
4. <u>Juncus effusus</u>	<u>10</u>	<u>H</u>	<u>FACW+</u>
5. <u>Lythrum salicaria</u>	<u>10</u>	<u>H</u>	<u>OBL</u>
✓ 6. <u>Phalaris arundinacea</u>	<u>60</u>	<u>H</u>	<u>FACW</u>
✓ 7. <u>Rosa nutkana</u>	<u>35</u>	<u>S</u>	<u>FAC</u>
8. <u>Rubus spectabilis</u>	<u>10</u>	<u>S</u>	<u>FAC+</u>
9. <u>Alnus rubra</u>	<u>15</u>	<u>T</u>	<u>FAC</u>

**03-11-14 Observations**

Athyrium filix-femina 10%  
 Cardamine oligosperma 2%  
 Carex obnupta 2%  
 Calystegia sp. 2%  
 Equisetm telmateia 40%  
 Juncus effusus 10%  
 Lythrum salicaria 10%  
 Phalaris arundinacea 60%  
 ornamental shrub/tree 35%  
 Rubus armeniacus 8%  
 Rubus spectabilis 10%  
 Alnus rubra 15%  
 Fraxinus latifolia 10%

Percent of **Dominant Species** that are OBL, FACW, or FAC (except FAC-). Include species noted (\*) as showing morphological adaptations to wetlands. "T" indicates trace. 100

**Remarks** (Describe disturbances, relevant local variations, seasonal effects, etc.):

*The percent of dominant species that are hydrophytic is greater than 50 percent. Hydrophytic vegetation criterion is satisfied.*

**HYDROLOGY**

**Recorded Data** (Describe in Remarks):

\_\_\_\_\_ Stream, Lake, or Tide Gage  
 \_\_\_\_\_ Aerial Photograph  
 \_\_\_\_\_ Other  
X No Recorded Data Available

**Wetland Hydrology Indicators** (Describe in Remarks):

Primary Indicators:

\_\_\_\_\_ Inundated  
X Saturated in Upper 12 inches  
 \_\_\_\_\_ Water Marks  
 \_\_\_\_\_ Drift Lines  
 \_\_\_\_\_ Sediment Deposits  
 \_\_\_\_\_ Drainage Patterns in Wetlands

Secondary Indicators (2 or more required):

\_\_\_\_\_ Oxidized Rhizospheres in Upper 12 inches  
 \_\_\_\_\_ Water-Stained Leaves  
 \_\_\_\_\_ Local Soil Survey Data  
 \_\_\_\_\_ Other (Explain in Remarks)

**Field Observations:**

Depth of Surface Water: none (in.)  
 Depth to Free Water in Pit: 9 (in.)  
 Depth to Saturated Soil: surface (in.)

**Remarks** (As relevant, describe recent precipitation, hydrologic modifications, local variations, etc.):

*Saturation in the upper 12 inches satisfies wetland hydrology criterion.*

03-11-14 Observations - Soil saturated at surface.

# Parametrix

Data Plot #: 15C-SP1  
Wetland: 15C

Project/Site: ELST Re-delineation Date: 10/31/2007 Revisited 03-11-14

## SOIL

### Soil Survey Data:

Map Unit Name: Alderwood gravelly sandy loam 6 to 15% slopes Drainage Class: Moderately well drained  
Field Observations Confirm Mapped Type?

Taxonomy (Subgroup): Entic Durochrepts Yes  No  NA

### Profile Description:

Depth (Inches)	Horizon Designation	Matrix Color (Munsell Moist)	Mottle Color (Munsell Moist)	Mottle Abundance/Contrast	Texture, Concretions, Rhizospheres, etc.
0-17	A	10YR 3/1	none	none	silt loam

### Hydric Soil Indicators:

- |   |   |
|---|---|
| <input type="checkbox"/> Histosol                               | <input type="checkbox"/> Listed on Hydric Soils List      |
| <input type="checkbox"/> Histic Epipedon                        | <input type="checkbox"/> Fe/Mn Concretions                |
| <input type="checkbox"/> Sulfidic Odor                          | <input type="checkbox"/> Organic Streaking in Sandy Soils |
| <input type="checkbox"/> Aquic or Peraguc Moisture Regime       | <input type="checkbox"/> Mottles (Redoximorphic Features) |
| <input type="checkbox"/> Reducing Conditions                    | <input type="checkbox"/> Other (Explain in Remarks)       |
| <input checked="" type="checkbox"/> Gleyed or Low-Chroma Colors |   |
| <input type="checkbox"/> High Organic Content in Surface Layer  |   |

Remarks (Describe soil disturbances, local variations, etc.):  
*Low chroma soil matrix color indicates hydric soils.*

## WETLAND DETERMINATION

Hydrophytic Vegetation Present? Yes  No  Is this Sampling Point Within a Wetland?  
Hydric Soils Present? Yes  No  Yes  No   
Wetland Hydrology Present? Yes  No

### Remarks

*Wetland vegetation, hydrology, and soil criteria are met. Therefore, the sample plot is located in a wetland.*

**WETLAND DETERMINATION DATA FORM**  
**Western Mountains, Valleys, and Coast Supplement to the**  
**1987 COE Wetlands Delineation Manual**

Project Site: <u>ELST – Re-delineation</u>	Sampling Date: <u>01-30-09</u> <span style="border: 1px solid red; padding: 2px;">Revisited 09-12-13</span>
Applicant/Owner: <u>King County</u>	Sampling Point: <u>W15D-SP1</u>
Investigator: <u>M. Maynard; C. Worsley</u>	City/County: <u>City of Sammamish</u>
Section, Township, Range: <u>S07, T24N, R06E</u>	State: <u>WA</u>
Landform (hillslope, terrace, etc) <u>ditch bottom</u> Slope (%) <u>0%</u>	Local relief (concave, convex, none) <u>none</u>
Subregion (LRR) <u>A</u> Lat _____	Long _____      Datum _____
Soil Map Unit Name <u>Alderwood gravelly sandy loam, 6 to 15 percent slopes</u>	NWI classification <u>PEM</u>
Are climatic/hydrologic conditions on the site typical for this time of year? <input checked="" type="checkbox"/> Yes <input type="checkbox"/> No	(If no, explain in remarks.)
Are "Normal Circumstances" present on the site? <input checked="" type="checkbox"/> Yes <input type="checkbox"/> No	
Are Vegetation <input checked="" type="checkbox"/> , Soil, <input type="checkbox"/> , or Hydrology <input type="checkbox"/> significantly disturbed? Yes	(If needed, explain any answers in Remarks.)
Are Vegetation <input type="checkbox"/> , Soil, <input type="checkbox"/> , or Hydrology <input type="checkbox"/> naturally problematic? No	

**SUMMARY OF FINDINGS – Attach site map showing sampling point locations, transects, important features, etc.**

Hydrophytic Vegetation Present? <input checked="" type="checkbox"/> Yes <input type="checkbox"/> No	<b>Is this Sampling Point within a Wetland?</b> <input checked="" type="checkbox"/> Yes <input type="checkbox"/> No
Hydric Soils Present? <input checked="" type="checkbox"/> Yes <input type="checkbox"/> No	
Wetland Hydrology Present? <input checked="" type="checkbox"/> Yes <input type="checkbox"/> No	
<i>Remarks:</i> Wetland 15D is located immediately north of SE 26th Street and east of the trail. Sample plot is near the south end of a split rail fence in the bottom of a ditch, approximately 6 feet NNE of flag W15D-20 and 2 feet E of split rail fence. The ditch in the wetland is maintained (vegetation cleared and sediment dredged). All three wetland criteria are satisfied indicating this area is wetland.	

**VEGETATION – Use scientific names of plants.**

Tree Stratum (Plot size <u>NA</u> )	Absolute % Cover	Dominant Species?	Indicator Status	Dominance Test Worksheet	
1.				Number of Dominant Species that are OBL, FACW, or FAC:	2 (A)
2.				Total Number of Dominant Species Across All Strata:	2 (B)
3.				Percent of Dominant Species that are OBL, FACW, or FAC:	100 (A/B)
4.					
_____ = Total Cover					
Sapling/Shrub Stratum (Plot size <u>NA</u> )				Prevalence Index Worksheet	
1.				Total % Cover of	
2.				Multiply by	
3.				OBL species	x 1 =
4.				FACW species	x 2 =
5.				FAC species	x 3 =
_____ = Total Cover				FACU species	x 4 =
				UPL species	x 5 =
				Column totals	(A)      (B)
				Prevalence Index = B / A =	
Herb Stratum (Plot size 5 feet, confined to wetland boundary)				Hydrophytic Vegetation Indicators	
1. Callitriche heterophylla	40	Yes	OBL	Yes	Dominance test is > 50%
2. Ranunculus repens	15	Yes	FACW		Prevalence test is ≤ 3.0 *
3. Lemna minor	10	No	OBL		Morphological Adaptations * (provide supporting data in remarks or on a separate sheet)
4. Cardamine oligosperma	10	No	FAC		Wetland Non-Vascular Plants *
5. Scirpus microcarpus	5	No	OBL		Problematic Hydrophytic Vegetation * (explain)
6. Nasturtium officinale	2	No	OBL		
7. Phalaris arundinacea	2	No	FACW		
8.					
9.					
10.					
11.					
50% = 42; 20% = 16.8				* Indicators of hydric soil and wetland hydrology must be present, unless disturbed or problematic	
_____ = Total Cover					
Woody Vine Stratum (Plot size <u>NA</u> )				Hydrophytic Vegetation Present?	
1.				Yes	<input checked="" type="checkbox"/>
2.				No	<input type="checkbox"/>
_____ = Total Cover					
% Bare Ground in Herb Stratum <u>30</u>					
<i>Remarks:</i> Hedera helix present along boundary edge, rooted in adjacent upland. 100% of the dominant species are hydrophytic. This satisfies the hydrophytic vegetation criterion.					

**Exhibit 16**  
**SSDP2016-00415**

**000824**

**Profile Description: (Describe to the depth needed to document the indicator or confirm the absence of indicators.)**

Depth (inches)	Matrix		Redox Features				Texture	Remarks
	Color (moist)	%	Color (moist)	%	Type <sup>1</sup>	Loc <sup>2</sup>		
0-18	N 2.5/1	100	-	-	-	-	Loamy sand	Some gravels and cobbles
18-20	10Y 3/1	100	-	-	-	-	sand	Some gravels and cobbles

<sup>1</sup>Type: C=Concentration, D=Depletion, RM=Reduced Matrix, CS=Covered or Coated Sand Grains    <sup>2</sup>Loc: PL=Pore Lining, M=Matrix

**Hydric Soil Indicators: (Applicable to all LRRs, unless otherwise noted.)**

- |  |   |
|--|---|
| <input type="checkbox"/> Histosol (A1)                       | <input type="checkbox"/> Sandy Redox (S5)                         |
| <input type="checkbox"/> Histic Epipedon (A2)                | <input type="checkbox"/> Stripped Matrix (S6)                     |
| <input type="checkbox"/> Black Histic (A3)                   | <input type="checkbox"/> Loamy Mucky Mineral (F1) (except MLRA 1) |
| <input type="checkbox"/> Hydrogen Sulfide (A4)               | <input type="checkbox"/> Loamy Gleyed Matrix (F2)                 |
| <input type="checkbox"/> Depleted Below Dark Surface (A11)   | <input type="checkbox"/> Depleted Matrix (F3)                     |
| <input checked="" type="checkbox"/> Thick Dark Surface (A12) | <input type="checkbox"/> Redox Dark Surface (F6)                  |
| <input type="checkbox"/> Sandy Mucky Mineral (S1)            | <input type="checkbox"/> Depleted Dark Surface (F7)               |
| <input type="checkbox"/> Sandy Gleyed Matrix (S4)            | <input type="checkbox"/> Redox Depressions (F8)                   |

**Indicators for Problematic Hydric Soils<sup>3</sup>**

- |   |
|---|
| <input type="checkbox"/> 2cm Muck (A10)             |
| <input type="checkbox"/> Red Parent Material (TF2)  |
| <input type="checkbox"/> Other (explain in remarks) |
| <input type="checkbox"/>                            |

<sup>3</sup> Indicators of hydrophytic vegetation and wetland hydrology must be present, unless disturbed or problematic

Restrictive Layer (if present):

Type: \_\_\_\_\_

Depth (inches): \_\_\_\_\_

Hydric soil present?

Yes

No

Remarks: A thick dark surface satisfies the hydric soil criterion.

**HYDROLOGY**

**Wetland Hydrology Indicators:**

Primary Indicators (minimum of one required; check all that apply):

- |  |  |
|--|--|
| <input checked="" type="checkbox"/> Surface water (A1)             | <input type="checkbox"/> Sparsely Vegetated Concave Surface (B8)               |
| <input checked="" type="checkbox"/> High Water Table (A2)          | <input type="checkbox"/> Water-Stained Leaves (except MLRA 1, 2, 4A & 4B) (B9) |
| <input checked="" type="checkbox"/> Saturation (A3)                | <input type="checkbox"/> Salt Crust (B11)                                      |
| <input type="checkbox"/> Water Marks (B1)                          | <input type="checkbox"/> Aquatic Invertebrates (B13)                           |
| <input type="checkbox"/> Sediment Deposits (B2)                    | <input type="checkbox"/> Hydrogen Sulfide Odor (C1)                            |
| <input type="checkbox"/> Drift Deposits (B3)                       | <input type="checkbox"/> Oxidized Rhizospheres along Living Roots (C3)         |
| <input type="checkbox"/> Algal Mat or Crust (B4)                   | <input type="checkbox"/> Presence of Reduced Iron (C4)                         |
| <input type="checkbox"/> Iron Deposits (B5)                        | <input type="checkbox"/> Recent Iron Reduction in Tilled Soils (C6)            |
| <input type="checkbox"/> Surface Soil Cracks (B6)                  | <input type="checkbox"/> Stunted or Stressed Plants (D1) (LRR A)               |
| <input type="checkbox"/> Inundation Visible on Aerial Imagery (B7) | <input type="checkbox"/> Other (explain in remarks)                            |

Secondary Indicators (2 or more required):

- |   |
|---|
| <input type="checkbox"/> Water-Stained Leaves (B9) (MLRA 1, 2, 4A & 4B) |
| <input type="checkbox"/> Drainage Patterns (B10)                        |
| <input type="checkbox"/> Dry-Season Water Table (C2)                    |
| <input type="checkbox"/> Saturation Visible on Aerial Imagery (C9)      |
| <input type="checkbox"/> Geomorphic Position (D2)                       |
| <input type="checkbox"/> Shallow Aquitard (D3)                          |
| <input type="checkbox"/> FAC-Neutral Test (D5)                          |
| <input type="checkbox"/> Raised Ant Mounds (D6) (LRR A)                 |
| <input type="checkbox"/> Frost-Heave Hummocks                           |

**Field Observations**

- |  |   |                             |                     |
|--|---|-----------------------------|---------------------|
| Surface Water Present?                             | <input checked="" type="checkbox"/> Yes | <input type="checkbox"/> No | Depth (in): 2       |
| Water Table Present?                               | <input checked="" type="checkbox"/> Yes | <input type="checkbox"/> No | Depth (in): NA      |
| Saturation Present?<br>(includes capillary fringe) | <input checked="" type="checkbox"/> Yes | <input type="checkbox"/> No | Depth (in): surface |

Wetland Hydrology Present?

Yes

No

Describe Recorded Data (stream gauge, monitoring well, aerial photos, previous inspections), if available:

Remarks: The presence of surface water satisfies the wetland hydrology criterion.

**WETLAND DETERMINATION DATA FORM**  
**Western Mountains, Valleys, and Coast Supplement to the**  
**1987 COE Wetlands Delineation Manual**

Project Site: <u>ELST – Re-delineation</u>	Sampling Date: <u>01-30-09</u> <span style="border: 1px solid red; padding: 2px;">Revised 09-12-13</span>
Applicant/Owner: <u>King County</u>	Sampling Point: <u>W15D-SP2</u>
Investigator: <u>M. Maynard; C. Worsley</u>	City/County: <u>City of Sammamish</u>
Section, Township, Range: <u>S07, T24N, R06E</u>	State: <u>WA</u>
Landform (hillslope, terrace, etc) <u>hillslope</u> Slope (%) <u>100%</u>	Local relief (concave, convex, none) <u>convex</u>
Subregion (LRR) <u>A</u> Lat _____	Long _____      Datum _____
Soil Map Unit Name <u>Alderwood gravelly sandy loam, 6 to 15 percent slopes</u>	NWI classification <u>NA</u>
Are climatic/hydrologic conditions on the site typical for this time of year? <input checked="" type="checkbox"/> Yes <input type="checkbox"/> No	(If no, explain in remarks.)
Are "Normal Circumstances" present on the site? <input checked="" type="checkbox"/> Yes <input type="checkbox"/> No	
Are Vegetation <input type="checkbox"/> , Soil, <input type="checkbox"/> , or Hydrology <input type="checkbox"/> significantly disturbed? No	(If needed, explain any answers in Remarks.)
Are Vegetation <input type="checkbox"/> , Soil, <input type="checkbox"/> , or Hydrology <input type="checkbox"/> naturally problematic? No	

**SUMMARY OF FINDINGS – Attach site map showing sampling point locations, transects, important features, etc.**

Hydrophytic Vegetation Present? <input type="checkbox"/> Yes <input checked="" type="checkbox"/> No	<b>Is this Sampling Point within a Wetland?</b> <input type="checkbox"/> Yes <input checked="" type="checkbox"/> No
Hydric Soils Present? <input checked="" type="checkbox"/> Yes <input type="checkbox"/> No	
Wetland Hydrology Present? <input type="checkbox"/> Yes <input checked="" type="checkbox"/> No	
<i>Remarks:</i> Wetland 15D is located immediately north of SE 26th Street and east of the trail. This paired upland sample plot is approximately 12 feet northeast of wetland flag W15D-20 on slope with ivy. Northeast of south end of split rail fence with wetland sign. Only one of the wetland criteria are satisfied indicating this area is not wetland.	

**VEGETATION – Use scientific names of plants.**

Tree Stratum (Plot size <u>NA</u> )	Absolute % Cover	Dominant Species?	Indicator Status	Dominance Test Worksheet	
1.				Number of Dominant Species that are OBL, FACW, or FAC:	1 (A)
2.				Total Number of Dominant Species Across All Strata:	2 (B)
3.				Percent of Dominant Species that are OBL, FACW, or FAC:	50 (A/B)
4.					
_____ = Total Cover					
Sapling/Shrub Stratum (Plot size <u>NA</u> )				Prevalence Index Worksheet	
1.				Total % Cover of	
2.				Multiply by	
3.				OBL species	x 1 =
4.				FACW species	x 2 =
5.				FAC species	x 3 =
_____ = Total Cover				FACU species	x 4 =
				UPL species	x 5 =
				Column totals	(A)      (B)
Herb Stratum (Plot size <u>5 feet</u> )				Prevalence Index = B / A =	
1. Cardamine oligosperma	5	Yes	FAC		
2.					
3.					
4.					
5.					
6.					
7.					
8.					
9.					
10.					
11.					
50% = 2.5; 20% = 1					
_____ 5 _____ = Total Cover					
Woody Vine Stratum (Plot size <u>30 feet, outside wetland boundary</u> )				* Indicators of hydric soil and wetland hydrology must be present, unless disturbed or problematic	
1. Hedera helix	80	NA	NL		
2. Rubus armeniacus	2	Yes	FACU		
50% = 1; 20% = 0.4					
_____ 2 _____ = Total Cover					
% Bare Ground in Herb Stratum					
<i>Remarks:</i> Only 50% of the dominant species are hydrophytic, and wetland hydrology is not present. The hydrophytic vegetation criterion is not satisfied.				Hydrophytic Vegetation Present?      Yes <input type="checkbox"/> No <input checked="" type="checkbox"/>	

**Exhibit 16**  
**SSDP2016-00415**

**Profile Description: (Describe to the depth needed to document the indicator or confirm the absence of indicators.)**

Depth (inches)	Matrix		Redox Features				Texture	Remarks
	Color (moist)	%	Color (moist)	%	Type <sup>1</sup>	Loc <sup>2</sup>		
0-20	10YR 4/1+	100	7.5YR 5/8	10	C	M	Silt loam and sand loam	Textures are mixed

<sup>1</sup>Type: C=Concentration, D=Depletion, RM=Reduced Matrix, CS=Covered or Coated Sand Grains    <sup>2</sup>Loc: PL=Pore Lining, M=Matrix

**Hydric Soil Indicators: (Applicable to all LRRs, unless otherwise noted.)**

- |  |   |
|--|---|
| <input type="checkbox"/> Histosol (A1)                     | <input type="checkbox"/> Sandy Redox (S5)                         |
| <input type="checkbox"/> Histic Epipedon (A2)              | <input type="checkbox"/> Stripped Matrix (S6)                     |
| <input type="checkbox"/> Black Histic (A3)                 | <input type="checkbox"/> Loamy Mucky Mineral (F1) (except MLRA 1) |
| <input type="checkbox"/> Hydrogen Sulfide (A4)             | <input type="checkbox"/> Loamy Gleyed Matrix (F2)                 |
| <input type="checkbox"/> Depleted Below Dark Surface (A11) | <input checked="" type="checkbox"/> Depleted Matrix (F3)          |
| <input type="checkbox"/> Thick Dark Surface (A12)          | <input type="checkbox"/> Redox Dark Surface (F6)                  |
| <input type="checkbox"/> Sandy Mucky Mineral (S1)          | <input type="checkbox"/> Depleted Dark Surface (F7)               |
| <input type="checkbox"/> Sandy Gleyed Matrix (S4)          | <input type="checkbox"/> Redox Depressions (F8)                   |

**Indicators for Problematic Hydric Soils<sup>3</sup>**

- 2cm Muck (A10)
- Red Parent Material (TF2)
- Other (explain in remarks)
- 

<sup>3</sup> Indicators of hydrophytic vegetation and wetland hydrology must be present, unless disturbed or problematic

Restrictive Layer (if present):

Type: \_\_\_\_\_

Depth (inches): \_\_\_\_\_

Hydric soil present?

Yes

No

Remarks: 10YR 3/2 inclusions (30%). The presence of a depleted matrix satisfies the hydric soil criterion.

**HYDROLOGY**

**Wetland Hydrology Indicators:**

Primary Indicators (minimum of one required; check all that apply):

- |  |  |
|--|--|
| <input type="checkbox"/> Surface water (A1)                        | <input type="checkbox"/> Sparsely Vegetated Concave Surface (B8)               |
| <input type="checkbox"/> High Water Table (A2)                     | <input type="checkbox"/> Water-Stained Leaves (except MLRA 1, 2, 4A & 4B) (B9) |
| <input type="checkbox"/> Saturation (A3)                           | <input type="checkbox"/> Salt Crust (B11)                                      |
| <input type="checkbox"/> Water Marks (B1)                          | <input type="checkbox"/> Aquatic Invertebrates (B13)                           |
| <input type="checkbox"/> Sediment Deposits (B2)                    | <input type="checkbox"/> Hydrogen Sulfide Odor (C1)                            |
| <input type="checkbox"/> Drift Deposits (B3)                       | <input type="checkbox"/> Oxidized Rhizospheres along Living Roots (C3)         |
| <input type="checkbox"/> Algal Mat or Crust (B4)                   | <input type="checkbox"/> Presence of Reduced Iron (C4)                         |
| <input type="checkbox"/> Iron Deposits (B5)                        | <input type="checkbox"/> Recent Iron Reduction in Tilled Soils (C6)            |
| <input type="checkbox"/> Surface Soil Cracks (B6)                  | <input type="checkbox"/> Stunted or Stressed Plants (D1) (LRR A)               |
| <input type="checkbox"/> Inundation Visible on Aerial Imagery (B7) | <input type="checkbox"/> Other (explain in remarks)                            |

Secondary Indicators (2 or more required):

- Water-Stained Leaves (B9) (MLRA 1, 2, 4A & 4B)
- Drainage Patterns (B10)
- Dry-Season Water Table (C2)
- Saturation Visible on Aerial Imagery (C9)
- Geomorphic Position (D2)
- Shallow Aquitard (D3)
- FAC-Neutral Test (D5)
- Raised Ant Mounds (D6) (LRR A)
- Frost-Heave Hummocks

**Field Observations**

- |  |                              |  |             |      |
|--|------------------------------|--|-------------|------|
| Surface Water Present?                             | <input type="checkbox"/> Yes | <input checked="" type="checkbox"/> No | Depth (in): |      |
| Water Table Present?                               | <input type="checkbox"/> Yes | <input checked="" type="checkbox"/> No | Depth (in): | none |
| Saturation Present?<br>(includes capillary fringe) | <input type="checkbox"/> Yes | <input checked="" type="checkbox"/> No | Depth (in): | none |

Wetland Hydrology Present?

Yes

No

Describe Recorded Data (stream gauge, monitoring well, aerial photos, previous inspections), if available:

Remarks: No primary or secondary indicators of wetland hydrology are present.



**WETLAND DETERMINATION DATA FORM**  
**Western Mountains, Valleys, and Coast Supplement to the**  
**1987 COE Wetlands Delineation Manual**

Project Site: <u>ELST – Re-delineation</u>	Sampling Date: <u>01-30-09</u> <span style="border: 1px solid red; padding: 2px;">Revised 09-12-13</span>
Applicant/Owner: <u>King County</u>	Sampling Point: <u>W15E-SP1</u>
Investigator: <u>M. Maynard; C. Worsley</u>	City/County: <u>City of Sammamish</u>
Section, Township, Range: <u>S07, T24N, R06E</u>	State: <u>WA</u>
Landform (hillslope, terrace, etc) <u>ditch bottom</u> Slope (%) <u>0%</u>	Local relief (concave, convex, none) <u>none</u>
Subregion (LRR) <u>A</u> Lat _____	Long _____      Datum _____
Soil Map Unit Name <u>Alderwood gravelly sandy loam, 6 to 15 percent slopes</u>	NWI classification <u>PEM</u>
Are climatic/hydrologic conditions on the site typical for this time of year? <input checked="" type="checkbox"/> Yes <input type="checkbox"/> No	(If no, explain in remarks.)
Are "Normal Circumstances" present on the site? <input checked="" type="checkbox"/> Yes <input type="checkbox"/> No	
Are Vegetation <input checked="" type="checkbox"/> , Soil, <input type="checkbox"/> , or Hydrology <input type="checkbox"/> significantly disturbed? Yes	(If needed, explain any answers in Remarks.)
Are Vegetation <input type="checkbox"/> , Soil, <input type="checkbox"/> , or Hydrology <input type="checkbox"/> naturally problematic? No	

**SUMMARY OF FINDINGS – Attach site map showing sampling point locations, transects, important features, etc.**

Hydrophytic Vegetation Present? <input checked="" type="checkbox"/> Yes <input type="checkbox"/> No	Is this Sampling Point within a Wetland? <input checked="" type="checkbox"/> Yes <input type="checkbox"/> No
Hydric Soils Present? <input checked="" type="checkbox"/> Yes <input type="checkbox"/> No	
Wetland Hydrology Present? <input checked="" type="checkbox"/> Yes <input type="checkbox"/> No	
<i>Remarks:</i> Wetland 15E is located immediately north of SE 26th Street and west of the trail. Sample plot is approximately 6 feet SSE of wetland flag W15E-7 in middle of ditch, east of Douglas-firs on slope. The ditch in the wetland is maintained (vegetation cleared and sediment dredged). All three wetland criteria are satisfied indicating this area is wetland.	

**VEGETATION – Use scientific names of plants.**

Tree Stratum (Plot size <u>NA</u> )	Absolute % Cover	Dominant Species?	Indicator Status	Dominance Test Worksheet			
1.				Number of Dominant Species that are OBL, FACW, or FAC:	5 (A)		
2.							
3.				Total Number of Dominant Species Across All Strata:	5 (B)		
4.							
_____ = Total Cover				Percent of Dominant Species that are OBL, FACW, or FAC:	100 (A/B)		
Sapling/Shrub Stratum (Plot size <u>NA</u> )				Prevalence Index Worksheet			
1.				Total % Cover of			
2.				Multiply by			
3.				OBL species	x 1 =		
4.				FACW species	x 2 =		
5.				FAC species	x 3 =		
_____ = Total Cover				FACU species	x 4 =		
				UPL species	x 5 =		
				Column totals	(A)      (B)		
Herb Stratum (Plot size <u>5 feet, confined to wetland boundary</u> )				Prevalence Index = B / A =			
1. <u>Nasturtium officinale</u>	<u>15</u>	<u>Yes</u>	<u>OBL</u>	<b>Hydrophytic Vegetation Indicators</b> Yes      Dominance test is > 50% Prevalence test is ≤ 3.0 * Morphological Adaptations * (provide supporting data in remarks or on a separate sheet) Wetland Non-Vascular Plants * Problematic Hydrophytic Vegetation * (explain)			
2. <u>Equisetum hyemale</u>	<u>15</u>	<u>Yes</u>	<u>FACW</u>				
3. <u>Ranunculus repens</u>	<u>10</u>	<u>Yes</u>	<u>FACW</u>				
4. <u>Lemna minor</u>	<u>10</u>	<u>Yes</u>	<u>OBL</u>				
5. <u>Poa trivialis</u>	<u>10</u>	<u>Yes</u>	<u>FACW</u>				
6. <u>Veronica americana</u>	<u>5</u>	<u>No</u>	<u>OBL</u>				
7. <u>Holcus lanatus</u>	<u>2</u>	<u>No</u>	<u>FAC</u>				
8.							
9.							
10.							
11.							
50% = 33.5; 20% = 13.4	<u>67</u>	_____ = Total Cover		* Indicators of hydric soil and wetland hydrology must be present, unless disturbed or problematic			
Woody Vine Stratum (Plot size <u>NA</u> )						<b>Hydrophytic Vegetation Present?</b> Yes <input checked="" type="checkbox"/> No <input type="checkbox"/>	
1.							
2.	_____ = Total Cover						
% Bare Ground in Herb Stratum <u>50</u>							
<i>Remarks:</i> 100% of the dominant species are hydrophytic. This satisfies the hydrophytic vegetation criterion.							

**Exhibit 16**  
**SSDP2016-00415**

**Profile Description: (Describe to the depth needed to document the indicator or confirm the absence of indicators.)**

Depth (inches)	Matrix		Redox Features				Texture	Remarks
	Color (moist)	%	Color (moist)	%	Type <sup>1</sup>	Loc <sup>2</sup>		
0-20	10YR 2/1	100	-	-	-	-	Sandy silt loam	See below

<sup>1</sup>Type: C=Concentration, D=Depletion, RM=Reduced Matrix, CS=Covered or Coated Sand Grains    <sup>2</sup>Loc: PL=Pore Lining, M=Matrix

**Hydric Soil Indicators: (Applicable to all LRRs, unless otherwise noted.)**

- |  |  |
|--|--|
| <input type="checkbox"/> Histosol (A1)                       | <input type="checkbox"/> Sandy Redox (S5)                                |
| <input type="checkbox"/> Histic Epipedon (A2)                | <input type="checkbox"/> Stripped Matrix (S6)                            |
| <input type="checkbox"/> Black Histic (A3)                   | <input type="checkbox"/> Loamy Mucky Mineral (F1) <b>(except MLRA 1)</b> |
| <input type="checkbox"/> Hydrogen Sulfide (A4)               | <input type="checkbox"/> Loamy Gleyed Matrix (F2)                        |
| <input type="checkbox"/> Depleted Below Dark Surface (A11)   | <input type="checkbox"/> Depleted Matrix (F3)                            |
| <input checked="" type="checkbox"/> Thick Dark Surface (A12) | <input type="checkbox"/> Redox Dark Surface (F6)                         |
| <input type="checkbox"/> Sandy Mucky Mineral (S1)            | <input type="checkbox"/> Depleted Dark Surface (F7)                      |
| <input type="checkbox"/> Sandy Gleyed Matrix (S4)            | <input type="checkbox"/> Redox Depressions (F8)                          |

**Indicators for Problematic Hydric Soils<sup>3</sup>**

- 2cm Muck (A10)
- Red Parent Material (TF2)
- Other (explain in remarks)

<sup>3</sup> Indicators of hydrophytic vegetation and wetland hydrology must be present, unless disturbed or problematic

Restrictive Layer (if present):

Type: \_\_\_\_\_

Depth (inches): \_\_\_\_\_

Hydric soil present?

Yes

No

Remarks: Decomposing organic matter and gravel throughout profile. A thick dark surface satisfies the hydric soil criterion.

**HYDROLOGY**

**Wetland Hydrology Indicators:**

Primary Indicators (minimum of one required; check all that apply):

- |  |   |
|--|---|
| <input checked="" type="checkbox"/> Surface water (A1)             | <input type="checkbox"/> Sparsely Vegetated Concave Surface (B8)                          |
| <input checked="" type="checkbox"/> High Water Table (A2)          | <input type="checkbox"/> Water-Stained Leaves <b>(except MLRA 1, 2, 4A &amp; 4B)</b> (B9) |
| <input checked="" type="checkbox"/> Saturation (A3)                | <input type="checkbox"/> Salt Crust (B11)   |
| <input type="checkbox"/> Water Marks (B1)                          | <input type="checkbox"/> Aquatic Invertebrates (B13)                                      |
| <input type="checkbox"/> Sediment Deposits (B2)                    | <input type="checkbox"/> Hydrogen Sulfide Odor (C1)                                       |
| <input type="checkbox"/> Drift Deposits (B3)                       | <input type="checkbox"/> Oxidized Rhizospheres along Living Roots (C3)                    |
| <input type="checkbox"/> Algal Mat or Crust (B4)                   | <input type="checkbox"/> Presence of Reduced Iron (C4)                                    |
| <input type="checkbox"/> Iron Deposits (B5)                        | <input type="checkbox"/> Recent Iron Reduction in Tilled Soils (C6)                       |
| <input type="checkbox"/> Surface Soil Cracks (B6)                  | <input type="checkbox"/> Stunted or Stressed Plants (D1) <b>(LRR A)</b>                   |
| <input type="checkbox"/> Inundation Visible on Aerial Imagery (B7) | <input type="checkbox"/> Other (explain in remarks)                                       |

Secondary Indicators (2 or more required):

- Water-Stained Leaves (B9) **(MLRA 1, 2, 4A & 4B)**
- Drainage Patterns (B10)
- Dry-Season Water Table (C2)
- Saturation Visible on Aerial Imagery (C9)
- Geomorphic Position (D2)
- Shallow Aquitard (D3)
- FAC-Neutral Test (D5)
- Raised Ant Mounds (D6) **(LRR A)**
- Frost-Heave Hummocks

**Field Observations**

- |  |   |                             |             |         |
|--|---|-----------------------------|-------------|---------|
| Surface Water Present?                             | <input checked="" type="checkbox"/> Yes | <input type="checkbox"/> No | Depth (in): | 3       |
| Water Table Present?                               | <input checked="" type="checkbox"/> Yes | <input type="checkbox"/> No | Depth (in): | NA      |
| Saturation Present?<br>(includes capillary fringe) | <input checked="" type="checkbox"/> Yes | <input type="checkbox"/> No | Depth (in): | surface |

Wetland Hydrology Present?

Yes

No

Describe Recorded Data (stream gauge, monitoring well, aerial photos, previous inspections), if available:

Remarks: The presence of surface water satisfies the wetland hydrology criterion.

**WETLAND DETERMINATION DATA FORM**  
**Western Mountains, Valleys, and Coast Supplement to the**  
**1987 COE Wetlands Delineation Manual**

Project Site: <u>ELST – Re-delineation</u>	Sampling Date: <u>01-30-09</u> <span style="border: 1px solid red; padding: 2px;">Revised 09-12-13</span>
Applicant/Owner: <u>King County</u>	Sampling Point: <u>W15E-SP2</u>
Investigator: <u>M. Maynard; C. Worsley</u>	City/County: <u>City of Sammamish</u>
Section, Township, Range: <u>S07, T24N, R06E</u>	State: <u>WA</u>
Landform (hillslope, terrace, etc) <u>hillslope</u> Slope (%) <u>100%</u>	Local relief (concave, convex, none) <u>convex</u>
Subregion (LRR) <u>A</u> Lat _____	Long _____      Datum _____
Soil Map Unit Name <u>Alderwood gravelly sandy loam, 6 to 15 percent slopes</u>	NWI classification <u>NA</u>
Are climatic/hydrologic conditions on the site typical for this time of year? <input checked="" type="checkbox"/> Yes <input type="checkbox"/> No	(If no, explain in remarks.)
Are "Normal Circumstances" present on the site? <input checked="" type="checkbox"/> Yes <input type="checkbox"/> No	
Are Vegetation <input type="checkbox"/> , Soil, <input type="checkbox"/> , or Hydrology <input type="checkbox"/> significantly disturbed? No	(If needed, explain any answers in Remarks.)
Are Vegetation <input type="checkbox"/> , Soil, <input type="checkbox"/> , or Hydrology <input type="checkbox"/> naturally problematic? No	

**SUMMARY OF FINDINGS – Attach site map showing sampling point locations, transects, important features, etc.**

Hydrophytic Vegetation Present? <input type="checkbox"/> Yes <input checked="" type="checkbox"/> No	<b>Is this Sampling Point within a Wetland?</b> <input type="checkbox"/> Yes <input checked="" type="checkbox"/> No
Hydric Soils Present? <input type="checkbox"/> Yes <input checked="" type="checkbox"/> No	
Wetland Hydrology Present? <input type="checkbox"/> Yes <input checked="" type="checkbox"/> No	
<i>Remarks:</i> Wetland 15E is located immediately north of SE 26th Street and west of the trail. This paired upland sample plot is approximately 15 feet SSW of wetland flag W15E-7 on slope under Douglas-firs. None of the wetland criteria are satisfied indicating this area is not wetland.	

**VEGETATION – Use scientific names of plants.**

Tree Stratum (Plot size 30 feet, outside wetland boundary)	Absolute % Cover	Dominant Species?	Indicator Status	Dominance Test Worksheet	
1. Pseudotsuga menziesii	95	Yes	FACU	Number of Dominant Species that are OBL, FACW, or FAC: _____	0 (A)
2.				Total Number of Dominant Species Across All Strata: _____	6 (B)
3.				Percent of Dominant Species that are OBL, FACW, or FAC: _____	0 (A/B)
4.	<u>95</u> = Total Cover				
Sapling/Shrub Stratum (Plot size 5 feet)				Prevalence Index Worksheet	
1. Corylus cornuta	20	Yes	FACU	Total % Cover of	
2. Arbutus menziesii	5	NA	NL	OBL species	Multiply by
3. Gaultheria shallon	5	Yes	FACU	FACW species	x 1 =
4.				FAC species	x 2 =
5.				FACU species	x 3 =
50% = 12.5; 20% = 5	<u>25</u> = Total Cover			UPL species	x 4 =
				Column totals	(A)      (B)
Herb Stratum (Plot size 5 feet)				Prevalence Index = B / A =	
1. Polystichum munitum	2	Yes	FACU	<b>Hydrophytic Vegetation Indicators</b>	
2.				No	Dominance test is > 50%
3.					Prevalence test is ≤ 3.0 *
4.					Morphological Adaptations * (provide supporting data in remarks or on a separate sheet)
5.					Wetland Non-Vascular Plants *
6.					Problematic Hydrophytic Vegetation * (explain)
7.					
8.					
9.					
10.					
11.	<u>2</u> = Total Cover			* Indicators of hydric soil and wetland hydrology must be present, unless disturbed or problematic	
Woody Vine Stratum (Plot size 30 feet, outside wetland boundary)				Hydrophytic Vegetation Present?      Yes <input type="checkbox"/> No <input checked="" type="checkbox"/>	
1. Rubus ursinus	15	Yes	FACU		
2. Rubus armeniacus	5	Yes	FACU		
3. Hedera helix	2	NA	NL		
50% = 10; 20% = 4	<u>20</u> = Total Cover				
% Bare Ground in Herb Stratum					
<i>Remarks:</i> None of the dominant species are hydrophytic, and hydric soil and wetland hydrology are not present. The hydrophytic vegetation criterion is not satisfied.					

**Exhibit 16**  
**SSDP2016-00415**

Profile Description: (Describe to the depth needed to document the indicator or confirm the absence of indicators.)								
Depth (inches)	Matrix		Redox Features				Texture	Remarks
	Color (moist)	%	Color (moist)	%	Type <sup>1</sup>	Loc <sup>2</sup>		
0-20	10YR 3/2	100	7.5YR 5/8	10	C	M	Gravelly sandy loam	

<sup>1</sup>Type: C=Concentration, D=Depletion, RM=Reduced Matrix, CS=Covered or Coated Sand Grains    <sup>2</sup>Loc: PL=Pore Lining, M=Matrix

**Hydric Soil Indicators: (Applicable to all LRRs, unless otherwise noted.)**

- |  |   |
|--|---|
| <input type="checkbox"/> Histosol (A1)                     | <input type="checkbox"/> Sandy Redox (S5)                         |
| <input type="checkbox"/> Histic Epipedon (A2)              | <input type="checkbox"/> Stripped Matrix (S6)                     |
| <input type="checkbox"/> Black Histic (A3)                 | <input type="checkbox"/> Loamy Mucky Mineral (F1) (except MLRA 1) |
| <input type="checkbox"/> Hydrogen Sulfide (A4)             | <input type="checkbox"/> Loamy Gleyed Matrix (F2)                 |
| <input type="checkbox"/> Depleted Below Dark Surface (A11) | <input type="checkbox"/> Depleted Matrix (F3)                     |
| <input type="checkbox"/> Thick Dark Surface (A12)          | <input type="checkbox"/> Redox Dark Surface (F6)                  |
| <input type="checkbox"/> Sandy Mucky Mineral (S1)          | <input type="checkbox"/> Depleted Dark Surface (F7)               |
| <input type="checkbox"/> Sandy Gleyed Matrix (S4)          | <input type="checkbox"/> Redox Depressions (F8)                   |

**Indicators for Problematic Hydric Soils<sup>3</sup>**

- 2cm Muck (A10)
- Red Parent Material (TF2)
- Other (explain in remarks)

<sup>3</sup> Indicators of hydrophytic vegetation and wetland hydrology must be present, unless disturbed or problematic

Restrictive Layer (if present):  
 Type: \_\_\_\_\_  
 Depth (inches): \_\_\_\_\_

**Hydric soil present?**    Yes     No

Remarks: Charcoal below 12 inches. No hydric soil indicators are present.

**HYDROLOGY**

**Wetland Hydrology Indicators:**

Primary Indicators (minimum of one required; check all that apply):

- |  |  |
|--|--|
| <input type="checkbox"/> Surface water (A1)                        | <input type="checkbox"/> Sparsely Vegetated Concave Surface (B8)               |
| <input type="checkbox"/> High Water Table (A2)                     | <input type="checkbox"/> Water-Stained Leaves (except MLRA 1, 2, 4A & 4B) (B9) |
| <input type="checkbox"/> Saturation (A3)                           | <input type="checkbox"/> Salt Crust (B11)                                      |
| <input type="checkbox"/> Water Marks (B1)                          | <input type="checkbox"/> Aquatic Invertebrates (B13)                           |
| <input type="checkbox"/> Sediment Deposits (B2)                    | <input type="checkbox"/> Hydrogen Sulfide Odor (C1)                            |
| <input type="checkbox"/> Drift Deposits (B3)                       | <input type="checkbox"/> Oxidized Rhizospheres along Living Roots (C3)         |
| <input type="checkbox"/> Algal Mat or Crust (B4)                   | <input type="checkbox"/> Presence of Reduced Iron (C4)                         |
| <input type="checkbox"/> Iron Deposits (B5)                        | <input type="checkbox"/> Recent Iron Reduction in Tilled Soils (C6)            |
| <input type="checkbox"/> Surface Soil Cracks (B6)                  | <input type="checkbox"/> Stunted or Stressed Plants (D1) (LRR A)               |
| <input type="checkbox"/> Inundation Visible on Aerial Imagery (B7) | <input type="checkbox"/> Other (explain in remarks)                            |

Secondary Indicators (2 or more required):

- Water-Stained Leaves (B9) (MLRA 1, 2, 4A & 4B)
- Drainage Patterns (B10)
- Dry-Season Water Table (C2)
- Saturation Visible on Aerial Imagery (C9)
- Geomorphic Position (D2)
- Shallow Aquitard (D3)
- FAC-Neutral Test (D5)
- Raised Ant Mounds (D6) (LRR A)
- Frost-Heave Hummocks

**Field Observations**

Surface Water Present?	<input type="checkbox"/> Yes	<input checked="" type="checkbox"/> No	Depth (in):	
Water Table Present?	<input type="checkbox"/> Yes	<input checked="" type="checkbox"/> No	Depth (in):	none
Saturation Present? (includes capillary fringe)	<input type="checkbox"/> Yes	<input checked="" type="checkbox"/> No	Depth (in):	none

**Wetland Hydrology Present?**    Yes     No

Describe Recorded Data (stream gauge, monitoring well, aerial photos, previous inspections), if available:

Remarks: No primary or secondary indicators of wetland hydrology are present.

# Parametrix

Data Plot #: 18C-SP1  
Wetland: 18C

## WETLAND DETERMINATION (Modified from: 1987 ACOE Wetlands Delineation Manual)

Project/Site: ELST Re-delineation Date: 10/31/2007 Revised 03-11-14  
Applicant/Owner: King County County: King  
Investigator: Matt Maynard, Chip Maney State: WA  
 1987 Method  1977 WA St. Method Community ID: PSS  
Do Normal Circumstances exist on the site? Yes X No \_\_\_\_\_ Field Plot ID: 18C-SP1  
Is the site significantly disturbed (Atypical Situation)? Yes \_\_\_\_\_ No X  
Is the area a potential Problem Area? Yes \_\_\_\_\_ No X

**Remarks** (Explain sample location, disturbances, problem areas):  
*This sample plot is located approximately 15 feet east of flag 18C-1.*

### VEGETATION (✓ Dominant species are checked)

	Plant Species	% Cover	Stratum	Indicator
1.	<u>Carex obnupta</u>	<u>5</u>	<u>H</u>	<u>OBL</u>
✓ 2.	<u>Cornus sericea</u>	<u>50</u>	<u>S</u>	<u>FACW</u>
3.	<u>Rubus armeniacus</u>	<u>trace</u>	<u>S</u>	<u>FACU</u>
✓ 4.	<u>Fraxinus latifolia</u>	<u>35</u>	<u>T</u>	<u>FACW</u>

Percent of **Dominant Species** that are OBL, FACW, or FAC (except FAC-). Include species noted (\*) as showing morphological adaptations to wetlands. "T" indicates trace. 100

**Remarks** (Describe disturbances, relevant local variations, seasonal effects, etc.):  
*The percent of dominant species that are hydrophytic is greater than 50 percent. Hydrophytic vegetation criterion is satisfied.*

### HYDROLOGY

**Recorded Data** (Describe in Remarks):

\_\_\_\_\_  
Stream, Lake, or Tide Gage  
\_\_\_\_\_  
Aerial Photograph  
\_\_\_\_\_  
Other  
X  
No Recorded Data Available

**Field Observations:**

Depth of Surface Water: none (in.)  
Depth to Free Water in Pit: 11 (in.)  
Depth to Saturated Soil: 6 (in.)

**Wetland Hydrology Indicators** (Describe in Remarks):

Primary Indicators:

\_\_\_\_\_  
Inundated  
X  
Saturated in Upper 12 inches  
\_\_\_\_\_  
Water Marks  
\_\_\_\_\_  
Drift Lines  
\_\_\_\_\_  
Sediment Deposits  
\_\_\_\_\_  
Drainage Patterns in Wetlands

Secondary Indicators (2 or more required):

\_\_\_\_\_  
Oxidized Rhizospheres in Upper 12 inches  
\_\_\_\_\_  
Water-Stained Leaves  
\_\_\_\_\_  
Local Soil Survey Data  
\_\_\_\_\_  
Other (Explain in Remarks)

**Remarks** (As relevant, describe recent precipitation, hydrologic modifications, local variations, etc.):  
*Saturation in the upper 12 inches satisfies wetland hydrology criterion.*

**03-11-14 Observations** - Inundation at 8 inches above the surface.

# Parametrix

Data Plot #: 18C-SP1  
Wetland: 18C

Project/Site: ELST Re-delineation Date: 10/31/2007 Revised 03-11-14

## SOIL

### Soil Survey Data:

Map Unit Name: Mixed Alluvial Land Drainage Class: Well drained to very poorly drained  
Field Observations Confirm Mapped Type?

Taxonomy (Subgroup): N/A Yes  No  NA

### Profile Description:

Depth (Inches)	Horizon Designation	Matrix Color (Munsell Moist)	Mottle Color (Munsell Moist)	Mottle Abundance/Contrast	Texture, Concretions, Rhizospheres, etc.
0-6	A	10YR 3/1	none	none	silt loam
6-12	A2	10YR 3/1	2.5Y 6/6	few, fine, prominent	gravelly silt loam
12-18	B	10YR 4/1	none	none	gravelly sandy loam

### Hydric Soil Indicators:

- |   |  |
|---|--|
| <input type="checkbox"/> Histosol                               | <input type="checkbox"/> Listed on Hydric Soils List                 |
| <input type="checkbox"/> Histic Epipedon                        | <input type="checkbox"/> Fe/Mn Concretions                           |
| <input type="checkbox"/> Sulfidic Odor                          | <input type="checkbox"/> Organic Streaking in Sandy Soils            |
| <input type="checkbox"/> Aquic or Peraguic Moisture Regime      | <input checked="" type="checkbox"/> Mottles (Redoximorphic Features) |
| <input type="checkbox"/> Reducing Conditions                    | <input type="checkbox"/> Other (Explain in Remarks)                  |
| <input checked="" type="checkbox"/> Gleyed or Low-Chroma Colors |  |
| <input type="checkbox"/> High Organic Content in Surface Layer  |  |

Remarks (Describe soil disturbances, local variations, etc.):  
*Chroma 1 soil and redoximorphic features indicate hydric soils.*

## WETLAND DETERMINATION

Hydrophytic Vegetation Present? Yes  No  Is this Sampling Point Within a Wetland?  
Hydric Soils Present? Yes  No  Yes  No   
Wetland Hydrology Present? Yes  No

### Remarks

*Wetland vegetation, hydrology, and soil criteria are met. Therefore, the sample plot is located in a wetland.*

Exhibit 16  
SSDP2016-00415  
000833

Data Plot #: 18C-SP2  
Wetland: Upland near 18C

## WETLAND DETERMINATION (Modified from: 1987 ACOE Wetlands Delineation Manual)

Project/Site: ELST Re-delineation Date: 10/31/2007 Revisited 03-11-14  
Applicant/Owner: King County County: King  
Investigator: Matt Maynard, Erik Christensen State: WA  
 1987 Method  1997 WA St. Method Community ID: Upland shrub  
Do Normal Circumstances exist on the site? Yes X No \_\_\_\_\_ Field Plot ID: 18C-SP2  
Is the site significantly disturbed (Atypical Situation)? Yes \_\_\_\_\_ No X  
Is the area a potential Problem Area? Yes \_\_\_\_\_ No X

**Remarks** (Explain sample location, disturbances, problem areas):

*This sample plot is located approximately 10 feet ~~south~~ of flag 18C-1.*

west

### VEGETATION (✓ Dominant species are checked)

Plant Species	% Cover	Stratum	Indicator
1. <u>Polystichum munitum</u>	<u>trace</u>	<u>H</u>	<u>FACU</u>
✓ 2. <u>Corylus cornuta</u>	<u>75</u>	<u>S</u>	<u>FACU</u>
3. <u>Gaultheria shallon</u>	<u>trace</u>	<u>S</u>	<u>FACU</u>
✓ 4. <u>Rubus armeniacus</u>	<u>45</u>	<u>S</u>	<u>FACU</u>
5. <u>Rubus laciniatus</u>	<u>trace</u>	<u>S</u>	<u>FACU+</u>
✓ 6. <u>Alnus rubra</u>	<u>25</u>	<u>T</u>	<u>FAC</u>

### 03-11-14 Observations

Polystichum munitum 2%  
Corylus cornuta 75%  
Gaultheria shallon 2%  
Rubus armeniacus 45%  
Rubus laciniatus 2%  
Acer macrophyllum 25%

Percent of **Dominant Species** that are OBL, FACW, or FAC (except FAC-). Include species noted (\*) as showing morphological adaptations to wetlands. "T" indicates trace. 33

**Remarks** (Describe disturbances, relevant local variations, seasonal effects, etc.):

*The percent of dominant species that are hydrophytic is not greater than 50 percent. Hydrophytic vegetation criterion is not satisfied.*

### HYDROLOGY

**Recorded Data** (Describe in Remarks):

\_\_\_\_\_ Stream, Lake, or Tide Gage  
\_\_\_\_\_ Aerial Photograph  
\_\_\_\_\_ Other  
X No Recorded Data Available

**Wetland Hydrology Indicators** (Describe in Remarks):

Primary Indicators:

\_\_\_\_\_ Inundated  
\_\_\_\_\_ Saturated in Upper 12 inches  
\_\_\_\_\_ Water Marks  
\_\_\_\_\_ Drift Lines  
\_\_\_\_\_ Sediment Deposits  
\_\_\_\_\_ Drainage Patterns in Wetlands

Secondary Indicators (2 or more required):

\_\_\_\_\_ Oxidized Rhizospheres in Upper 12 inches  
\_\_\_\_\_ Water-Stained Leaves  
\_\_\_\_\_ Local Soil Survey Data  
\_\_\_\_\_ Other (Explain in Remarks)

**Field Observations:**

Depth of Surface Water: none (in.)  
Depth to Free Water in Pit: none (in.)  
Depth to Saturated Soil: none (in.)

**Remarks** (As relevant, describe recent precipitation, hydrologic modifications, local variations, etc.):

*No primary or secondary indicators of hydrology are present. Wetland hydrology criterion is not satisfied.*

# Parametrix

Data Plot #: 18C-SP2  
Wetland: Upland near 18C

Project/Site: ELST Re-delineation Date: 10/31/2007 Revisited 03-11-14

## SOIL

### Soil Survey Data:

Map Unit Name: Mixed Alluvial Land Drainage Class: Well drained to very poorly drained  
Field Observations Confirm Mapped Type?

Taxonomy (Subgroup): N/A Yes  No  NA

### Profile Description:

Depth (Inches)	Horizon Designation	Matrix Color (Munsell Moist)	Mottle Color (Munsell Moist)	Mottle Abundance/Contrast	Texture, Concretions, Rhizospheres, etc.
0-5	A	10YR 2/1	none	none	sandy loam
5-17	B	2.5Y 4/2	none	none	sandy loam

### Hydric Soil Indicators:

- |  |   |
|--|---|
| <input type="checkbox"/> Histosol                              | <input type="checkbox"/> Listed on Hydric Soils List      |
| <input type="checkbox"/> Histic Epipedon                       | <input type="checkbox"/> Fe/Mn Concretions                |
| <input type="checkbox"/> Sulfidic Odor                         | <input type="checkbox"/> Organic Streaking in Sandy Soils |
| <input type="checkbox"/> Aquic or Peraguc Moisture Regime      | <input type="checkbox"/> Mottles (Redoximorphic Features) |
| <input type="checkbox"/> Reducing Conditions                   | <input type="checkbox"/> Other (Explain in Remarks)       |
| <input type="checkbox"/> Gleyed or Low-Chroma Colors           |   |
| <input type="checkbox"/> High Organic Content in Surface Layer |   |

Remarks (Describe soil disturbances, local variations, etc.):  
*No hydric soil indicators are present.*

## WETLAND DETERMINATION

Hydrophytic Vegetation Present? Yes  No  Is this Sampling Point Within a Wetland?  
Hydric Soils Present? Yes  No  Yes  No   
Wetland Hydrology Present? Yes  No

Remarks  
*Wetland vegetation, hydrology, and soil criteria are not met. Therefore, the sample plot is not located in a wetland.*



Data Plot #: 19A-SP1  
 Wetland: 19A

## WETLAND DETERMINATION (Modified from: 1987 ACOE Wetlands Delineation Manual)

Project/Site: ELST Re-delineation Date: 11/1/2007 Revised 09-12-13  
 Applicant/Owner: King County County: King  
 Investigator: Chip Maney, Chrissy Bailey State: WA  
 1987 Method  1997 WA St. Method Community ID: PEM  
 Do Normal Circumstances exist on the site? Yes X No \_\_\_\_\_ Field Plot ID: 19A-SP1  
 Is the site significantly disturbed (Atypical Situation)? Yes \_\_\_\_\_ No X  
 Is the area a potential Problem Area? Yes \_\_\_\_\_ No X

**Remarks** (Explain sample location, disturbances, problem areas):

*This sample plot is located 1 foot north of the stairway up to the lawn in a ditch even with the split fence post. It is thin and narrow. New gravel has recently been placed for fill for the stairs.*

### VEGETATION (✓ Dominant species are checked)

	Plant Species	% Cover	Stratum	Indicator
✓ 1.	<u>Juncus effusus</u>	<u>30</u>	<u>H</u>	<u>FACW+</u>
2.	<u>Lotus corniculatus</u>	<u>trace</u>	<u>H</u>	<u>FAC</u>
✓ 3.	<u>mowed lawn</u>	<u>30</u>	<u>H</u>	
✓ 4.	<u>Phalaris arundinacea</u>	<u>20</u>	<u>H</u>	<u>FACW</u>
5.	<u>Polystichum munitum</u>	<u>trace</u>	<u>H</u>	<u>FACU</u>
✓ 6.	<u>Gaultheria shallon</u>	<u>30</u>	<u>S</u>	<u>FACU</u>
7.	<u>Ilex aquifolium</u>	<u>trace</u>	<u>S</u>	<u>NL</u>
8.	<u>Rubus armeniacus</u>	<u>10</u>	<u>S</u>	<u>FACU</u>
9.	<u>Fraxinus latifolia</u>	<u>10</u>	<u>T</u>	<u>FACW</u>

Percent of **Dominant Species** that are OBL, FACW, or FAC (except FAC-). Include species noted (\*) as showing morphological adaptations to wetlands. "T" indicates trace. 67

**Remarks** (Describe disturbances, relevant local variations, seasonal effects, etc.):

*The percent of dominant species that are hydrophytic is greater than 50 percent. Hydrophytic vegetation criterion is satisfied.*

### HYDROLOGY

**Recorded Data** (Describe in Remarks):

\_\_\_\_\_  
 Stream, Lake, or Tide Gage  
 \_\_\_\_\_  
 Aerial Photograph  
 \_\_\_\_\_  
 Other  
 \_\_\_\_\_  
 X No Recorded Data Available

**Wetland Hydrology Indicators** (Describe in Remarks):

Primary Indicators:  
 \_\_\_\_\_ X Inundated  
 \_\_\_\_\_ X Saturated in Upper 12 inches  
 \_\_\_\_\_  
 Water Marks  
 \_\_\_\_\_  
 Drift Lines  
 \_\_\_\_\_  
 Sediment Deposits  
 \_\_\_\_\_  
 Drainage Patterns in Wetlands

**Field Observations:**

Depth of Surface Water: 4.5 (in.)  
 Depth to Free Water in Pit: na (in.)  
 Depth to Saturated Soil: surface (in.)

Secondary Indicators (2 or more required):  
 \_\_\_\_\_  
 Oxidized Rhizospheres in Upper 12 inches  
 \_\_\_\_\_  
 Water-Stained Leaves  
 \_\_\_\_\_  
 Local Soil Survey Data  
 \_\_\_\_\_  
 Other (Explain in Remarks)

**Remarks** (As relevant, describe recent precipitation, hydrologic modifications, local variations, etc.):

*Inundation to a depth of 4.5 inches satisfies wetland hydrology criterion.*

**09-12-13 Observations** - Saturated at 6 inches below surface. Free water in pit at 11 inches below surface.

# Parametrix

Data Plot #: 19A-SP1

Wetland: 19A

Project/Site: ELST Re-delineation

Date: 11/1/2007

Revisited 09-12-13

## SOIL

### Soil Survey Data:

Map Unit Name: Alderwood gravelly sandy loam 6 to 15 % slopes

Drainage Class: moderately well drained

Field Observations Confirm Mapped Type?

Taxonomy (Subgroup): Dystric Durochrepts

Yes  No  NA

### Profile Description:

Depth (Inches)	Horizon Designation	Matrix Color (Munsell Moist)	Mottle Color (Munsell Moist)	Mottle Abundance/Contrast	Texture, Concretions, Rhizospheres, etc.
0-19	A	6/5 BG	7.5YR 5/8	many, coarse, prominent	silt loam

### 09-12-13 Observations -

0-10	7.5YR 3/1 (100%)	none	none	silt loam
10-18	2.5Y 4/1 (98%)	2.5Y 5/6	2%	silt loam

### Hydric Soil Indicators:

<input type="checkbox"/> Histosol	<input type="checkbox"/> Listed on Hydric Soils List
<input type="checkbox"/> Histic Epipedon	<input type="checkbox"/> Fe/Mn Concretions
<input type="checkbox"/> Sulfidic Odor	<input type="checkbox"/> Organic Streaking in Sandy Soils
<input type="checkbox"/> Aquic or Peraguc Moisture Regime	<input checked="" type="checkbox"/> Mottles (Redoximorphic Features)
<input type="checkbox"/> Reducing Conditions	<input type="checkbox"/> Other (Explain in Remarks)
<input checked="" type="checkbox"/> Gleyed or Low-Chroma Colors	
<input type="checkbox"/> High Organic Content in Surface Layer	

Remarks (Describe soil disturbances, local variations, etc.):

*Gleyed soil and redoximorphic features indicate hydric soils.*

## WETLAND DETERMINATION

Hydrophytic Vegetation Present?

Yes  No

Is this Sampling Point Within a Wetland?

Hydric Soils Present?

Yes  No

Yes  No

Wetland Hydrology Present?

Yes  No

### Remarks

*Wetland vegetation, hydrology, and soil criteria are met. Therefore, the sample plot is located in a wetland.*

Exhibit 16  
SSDP2016-00415  
000837

# WETLAND DETERMINATION DATA FORM – Western Mountains, Valleys, and Coast Region

Project Site: ELST - South Sammamish Segment City/County: Sammamish/King Sampling Date: 03-11-14  
 Applicant/Owner: King County State: WA Sampling Point: W19B-SP1 (rev)  
 Investigator(s): C. Worsley; M. Maynard Section, Township, Range: S06, T24N, R06E  
 Landform (hillslope, terrace, etc.): Slope Local relief (concave, convex, none): none Slope (%): 8%  
 Subregion (LRR): A Lat: \_\_\_\_\_ Long: \_\_\_\_\_ Datum: \_\_\_\_\_  
 Soil Map Unit Name: Alderwood gravelly sandy loam, 15 to 30% slopes NWI classification: PSS/PEM edge  
 Are climatic / hydrologic conditions on the site typical for this time of year? Yes  No  (If no, explain in Remarks.)  
 Are Vegetation , Soil , or Hydrology , significantly disturbed? Are "Normal Circumstances" present? Yes  No   
 Are Vegetation , Soil , or Hydrology , naturally problematic? (If needed, explain any answers in Remarks.)

### SUMMARY OF FINDINGS – Attach site map showing sampling point locations, transects, important features, etc.

Hydrophytic Vegetation Present?	Yes <input checked="" type="checkbox"/>	No <input type="checkbox"/>	<b>Is the Sampled Area within a Wetland?</b>	Yes <input checked="" type="checkbox"/>	No <input type="checkbox"/>
Hydric Soil Present?	Yes <input checked="" type="checkbox"/>	No <input type="checkbox"/>		Yes <input checked="" type="checkbox"/>	No <input type="checkbox"/>
Wetland Hydrology Present?	Yes <input checked="" type="checkbox"/>	No <input type="checkbox"/>		Yes <input checked="" type="checkbox"/>	No <input type="checkbox"/>
Remarks: Sample plot is located at maintained lawn / Himalayan blackberry edge, approximately 30 feet north of south structure in wetland. The old sample plot location has been filled, landscaped, and terraced. Data from this revised sample plot replaces data previously collected from the old sample plot.					

### VEGETATION – Use scientific names of plants

Tree Stratum (Plot size: <u>NA</u> )	Absolute % Cover	Dominant Species?	Indicator Status	Dominance Test Worksheet:																
1. _____	_____	_____	_____	Number of Dominant Species That Are OBL, FACW, or FAC: <u>1</u> (A)  Total Number of Dominant Species Across All Strata: <u>2</u> (B)  Percent of Dominant Species That Are OBL, FACW, or FAC: <u>50</u> (A/B)																
2. _____	_____	_____	_____																	
3. _____	_____	_____	_____																	
4. _____	_____	_____	_____																	
50% = _____, 20% = _____	_____	= Total Cover		<b>Prevalence Index worksheet:</b>  <table style="width: 100%; border: none;"> <tr> <td style="text-align: center;">Total % Cover of:</td> <td style="text-align: center;">Multiply by:</td> </tr> <tr> <td>OBL species _____</td> <td>x1 = _____</td> </tr> <tr> <td>FACW species _____</td> <td>x2 = _____</td> </tr> <tr> <td>FAC species _____</td> <td>x3 = _____</td> </tr> <tr> <td>FACU species _____</td> <td>x4 = _____</td> </tr> <tr> <td>UPL species _____</td> <td>x5 = _____</td> </tr> <tr> <td>Column Totals: _____ (A)</td> <td>_____ (B)</td> </tr> <tr> <td colspan="2" style="text-align: center;">Prevalence Index = B/A = _____</td> </tr> </table>	Total % Cover of:	Multiply by:	OBL species _____	x1 = _____	FACW species _____	x2 = _____	FAC species _____	x3 = _____	FACU species _____	x4 = _____	UPL species _____	x5 = _____	Column Totals: _____ (A)	_____ (B)	Prevalence Index = B/A = _____	
Total % Cover of:	Multiply by:																			
OBL species _____	x1 = _____																			
FACW species _____	x2 = _____																			
FAC species _____	x3 = _____																			
FACU species _____	x4 = _____																			
UPL species _____	x5 = _____																			
Column Totals: _____ (A)	_____ (B)																			
Prevalence Index = B/A = _____																				
<b>Sapling/Shrub Stratum (Plot size: <u>NA</u>)</b>																				
1. _____	_____	_____	_____																	
2. _____	_____	_____	_____																	
3. _____	_____	_____	_____																	
4. _____	_____	_____	_____																	
5. _____	_____	_____	_____																	
50% = _____, 20% = _____	_____	= Total Cover																		
<b>Herb Stratum (Plot size: <u>3 feet</u>)</b>																				
1. <u>maintained lawn</u>	<u>50</u>	<u>yes</u>	<u>:</u>																	
2. <u>Calystegia sepium</u>	<u>30</u>	<u>yes</u>	<u>FAC</u>																	
3. _____	_____	_____	_____																	
4. _____	_____	_____	_____																	
5. _____	_____	_____	_____																	
6. _____	_____	_____	_____																	
7. _____	_____	_____	_____																	
8. _____	_____	_____	_____																	
9. _____	_____	_____	_____																	
10. _____	_____	_____	_____																	
11. _____	_____	_____	_____																	
50% = <u>40</u> , 20% = <u>16</u>	<u>80</u>	= Total Cover																		
<b>Woody Vine Stratum (Plot size: <u>10 feet</u>)</b>																				
1. <u>Rubus armeniacus</u>	<u>50</u>	<u>yes</u>	<u>FACU</u>																	
2. _____	_____	_____	_____																	
50% = <u>25</u> , 20% = <u>10</u>	<u>50</u>	= Total Cover																		
% Bare Ground in Herb Stratum _____																				
<b>Hydrophytic Vegetation Present?</b> Yes <input checked="" type="checkbox"/> No <input type="checkbox"/>																				

Remarks: Vegetation has been altered as part of disturbance and landscaping from residence. The wetland vegetation criterion is satisfied based on the presence of wetland hydrology and hydric soils.

**SOIL**

Profile Description: (Describe to the depth needed to document the indicator or confirm the absence of indicators.)										
Depth (inches)	Matrix		Redox Features				Texture	Remarks		
	Color (moist)	%	Color (moist)	%	Type <sup>1</sup>	Loc <sup>2</sup>				
0-14	10YR 2/1	100	-	-	-	-	gr sa loam			
14-19	10YR 4/1	90	10YR 5/8	10	C	M	gr clay loam			
<sup>1</sup> Type: C= Concentration, D=Depletion, RM=Reduced Matrix, CS=Covered or Coated Sand Grains. <sup>2</sup> Location: PL=Pore Lining, M=Matrix										
<b>Hydric Soil Indicators: (Applicable to all LRRs, unless otherwise noted.)</b>						<b>Indicators for Problematic Hydric Soils<sup>3</sup>:</b>				
<input type="checkbox"/>	Histosol (A1)	<input type="checkbox"/>	Sandy Redox (S5)	<input type="checkbox"/>	2 cm Muck (A10)					
<input type="checkbox"/>	Histic Epipedon (A2)	<input type="checkbox"/>	Stripped Matrix (S6)	<input type="checkbox"/>	Red Parent Material (TF2)					
<input type="checkbox"/>	Black Histic (A3)	<input type="checkbox"/>	Loamy Mucky Mineral (F1) (except MLRA 1)	<input type="checkbox"/>	Very Shallow Dark Surface (TF12)					
<input type="checkbox"/>	Hydrogen Sulfide (A4)	<input type="checkbox"/>	Loamy Gleyed Matrix (F2)	<input type="checkbox"/>	Other (Explain in Remarks)					
<input type="checkbox"/>	Depleted Below Dark Surface (A11)	<input type="checkbox"/>	Depleted Matrix (F3)							
<input checked="" type="checkbox"/>	Thick Dark Surface (A12)	<input type="checkbox"/>	Redox Dark Surface (F6)							
<input type="checkbox"/>	Sandy Mucky Mineral (S1)	<input type="checkbox"/>	Depleted Dark Surface (F7)				<sup>3</sup> Indicators of hydrophytic vegetation and wetland hydrology must be present, unless disturbed or problematic.			
<input type="checkbox"/>	Sandy Gleyed Matrix (S4)	<input type="checkbox"/>	Redox Depressions (F8)							
<b>Restrictive Layer (if present):</b>										
Type:	_____									
Depth (inches):	_____	<b>Hydric Soils Present?</b>					Yes	<input checked="" type="checkbox"/>	No	<input type="checkbox"/>
Remarks:										

**HYDROLOGY**

<b>Wetland Hydrology Indicators:</b>								
Primary Indicators (minimum of one required; check all that apply)			Secondary Indicators (2 or more required)					
<input type="checkbox"/>	Surface Water (A1)	<input type="checkbox"/>	Water-Stained Leaves (B9)	<input type="checkbox"/>	Water-Stained Leaves (B9)			
<input checked="" type="checkbox"/>	High Water Table (A2)	<input type="checkbox"/>	(except MLRA 1, 2, 4A, and 4B)	<input type="checkbox"/>	(MLRA 1, 2, 4A, and 4B)			
<input checked="" type="checkbox"/>	Saturation (A3)	<input type="checkbox"/>	Salt Crust (B11)	<input type="checkbox"/>	Drainage Patterns (B10)			
<input type="checkbox"/>	Water Marks (B1)	<input type="checkbox"/>	Aquatic Invertebrates (B13)	<input type="checkbox"/>	Dry-Season Water Table (C2)			
<input type="checkbox"/>	Sediment Deposits (B2)	<input type="checkbox"/>	Hydrogen Sulfide Odor (C1)	<input type="checkbox"/>	Saturation Visible on Aerial Imagery (C9)			
<input type="checkbox"/>	Drift Deposits (B3)	<input type="checkbox"/>	Oxidized Rhizospheres along Living Roots (C3)	<input type="checkbox"/>	Geomorphic Position (D2)			
<input type="checkbox"/>	Algal Mat or Crust (B4)	<input type="checkbox"/>	Presence of Reduced Iron (C4)	<input type="checkbox"/>	Shallow Aquitard (D3)			
<input type="checkbox"/>	Iron Deposits (B5)	<input type="checkbox"/>	Recent Iron Reduction in Tilled Soils (C6)	<input type="checkbox"/>	FAC-Neutral Test (D5)			
<input type="checkbox"/>	Surface Soil Cracks (B6)	<input type="checkbox"/>	Stunted or Stresses Plants (D1) (LRR A)	<input type="checkbox"/>	Raised Ant Mounds (D6) (LRR A)			
<input type="checkbox"/>	Inundation Visible on Aerial Imagery (B7)	<input type="checkbox"/>	Other (Explain in Remarks)	<input type="checkbox"/>	Frost-Heave Hummocks (D7)			
<input type="checkbox"/>	Sparsely Vegetated Concave Surface (B8)							
<b>Field Observations:</b>								
Surface Water Present?	Yes	<input type="checkbox"/>	No	<input checked="" type="checkbox"/>	Depth (inches): _____			
Water Table Present?	Yes	<input checked="" type="checkbox"/>	No	<input type="checkbox"/>	Depth (inches): <u>3</u>			
Saturation Present? (includes capillary fringe)	Yes	<input checked="" type="checkbox"/>	No	<input type="checkbox"/>	Depth (inches): <u>surface</u>			
<b>Wetland Hydrology Present?</b>					Yes	<input checked="" type="checkbox"/>	No	<input type="checkbox"/>
Describe Recorded Data (stream gauge, monitoring well, aerial photos, previous inspections), if available:								
Remarks:								

**Exhibit 16**  
**SSDP2016-00415**

Data Plot #: 19B-SP2  
 Wetland: Upland near 19B

## WETLAND DETERMINATION (Modified from: 1987 ACOE Wetlands Delineation Manual)

Project/Site: ELST Re-delineation Date: 10/31/2007 Revisited 03-11-14  
 Applicant/Owner: King County County: King County  
 Investigator: Michael Muscari/Laura Brock State: WA  
 1987 Method  1997 WA St. Method Community ID: Upland Shrub  
 Do Normal Circumstances exist on the site? Yes X No \_\_\_\_\_ Field Plot ID: 19B-SP2  
 Is the site significantly disturbed (Atypical Situation)? Yes \_\_\_\_\_ No X  
 Is the area a potential Problem Area? Yes \_\_\_\_\_ No X

**Remarks** (Explain sample location, disturbances, problem areas):  
*This sample plot is located approximately 10' south of flag 19B-8.*

### VEGETATION (✓ Dominant species are checked)

Plant Species	% Cover	Stratum	Indicator
1. <u>Equisetum telmateia</u>	<u>trace</u>	<u>Herb</u>	<u>FACW</u>
✓ 2. <u>Hedera helix</u>	<u>100</u>	<u>Herb</u>	<u>NL</u>
3. <u>Polystichum munitum</u>	<u>5</u>	<u>Herb</u>	<u>FACU</u>
✓ 4. <u>Rubus armeniacus</u>	<u>40</u>	<u>Shrub</u>	<u>FACU</u>
5. <u>Symphoricarpos albus</u>	<u>15</u>	<u>Shrub</u>	<u>FACU</u>

**03-11-14 Observations**  
 Calystegia sepium 50%  
 Corylus cornuta 20%  
 Gaultheria shallon 35%  
 Oemleria cerasiformis 5%  
 Rubus armeniacus 80%  
 Sambucus racemosa 2%

Percent of **Dominant Species** that are OBL, FACW, or FAC (except FAC-). Include species noted (\*) as showing morphological adaptations to wetlands. "T" indicates trace. 0

**Remarks** (Describe disturbances, relevant local variations, seasonal effects, etc.):  
*Rubus armeniacus and English Ivy are dominant. The percent of dominant species that are hydrophytic is not greater than 50 percent. Hydrophytic vegetation criterion is not satisfied.*

### HYDROLOGY

**Recorded Data** (Describe in Remarks):  
 \_\_\_\_\_ Stream, Lake, or Tide Gage  
 \_\_\_\_\_ Aerial Photograph  
 \_\_\_\_\_ Other  
X No Recorded Data Available

**Wetland Hydrology Indicators** (Describe in Remarks):  
 Primary Indicators:  
 \_\_\_\_\_ Inundated  
 \_\_\_\_\_ Saturated in Upper 12 inches  
 \_\_\_\_\_ Water Marks  
 \_\_\_\_\_ Drift Lines  
 \_\_\_\_\_ Sediment Deposits  
 \_\_\_\_\_ Drainage Patterns in Wetlands

**Field Observations:**

Depth of Surface Water: none (in.)  
 Depth to Free Water in Pit: none (in.)  
 Depth to Saturated Soil: none (in.)

Secondary Indicators (2 or more required):  
 \_\_\_\_\_ Oxidized Rhizospheres in Upper 12 inches  
 \_\_\_\_\_ Water-Stained Leaves  
 \_\_\_\_\_ Local Soil Survey Data  
 \_\_\_\_\_ Other (Explain in Remarks)

**Remarks** (As relevant, describe recent precipitation, hydrologic modifications, local variations, etc.):  
*Soils dry to 14". No primary or secondary indicators of hydrology are present. Wetland hydrology criterion is not satisfied.*

# Parametrix

Data Plot #: 19B-SP2  
Wetland: Upland near 19B

Project/Site: ELST Re-delineation Date: 10/31/2007 Revisited 03-11-14

## SOIL

### Soil Survey Data:

Map Unit Name: Alderwood gravelly sandy loam, 15 to 30 % slopes Drainage Class: Moderately well drained  
Field Observations Confirm Mapped Type?

Taxonomy (Subgroup): Dystric Durochrepts Yes  No  NA

### Profile Description:

Depth (Inches)	Horizon Designation	Matrix Color (Munsell Moist)	Mottle Color (Munsell Moist)	Mottle Abundance/Contrast	Texture, Concretions, Rhizospheres, etc.
0-14+	A	10YR 2/2	none	none	loam

### Hydric Soil Indicators:

- |  |   |
|--|---|
| <input type="checkbox"/> Histosol                              | <input type="checkbox"/> Listed on Hydric Soils List      |
| <input type="checkbox"/> Histic Epipedon                       | <input type="checkbox"/> Fe/Mn Concretions                |
| <input type="checkbox"/> Sulfidic Odor                         | <input type="checkbox"/> Organic Streaking in Sandy Soils |
| <input type="checkbox"/> Aquic or Peraguc Moisture Regime      | <input type="checkbox"/> Mottles (Redoximorphic Features) |
| <input type="checkbox"/> Reducing Conditions                   | <input type="checkbox"/> Other (Explain in Remarks)       |
| <input type="checkbox"/> Gleyed or Low-Chroma Colors           |   |
| <input type="checkbox"/> High Organic Content in Surface Layer |   |

Remarks (Describe soil disturbances, local variations, etc.):  
*No hydric soil indicators are present. Hydric soil criterion is not satisfied.*

## WETLAND DETERMINATION

Hydrophytic Vegetation Present? Yes  No  Is this Sampling Point Within a Wetland?  
Hydric Soils Present? Yes  No  Yes  No   
Wetland Hydrology Present? Yes  No

Remarks  
*Hydrophytic vegetation, hydric soil, and wetland hydrology criteria are not satisfied. Therefore, the sample plot is not located in a wetland.*

Data Plot #: 20A-SP1  
 Wetland: 20A

## WETLAND DETERMINATION (Modified from: 1987 ACOE Wetlands Delineation Manual)

Project/Site: ELST Re-delineation Date: 11/1/2007 Revisited 09-12-13  
 Applicant/Owner: King County County: King  
 Investigator: Chrissy Bailey State: WA  
 1987 Method  1977 WA St. Method Community ID: PEM  
 Do Normal Circumstances exist on the site? Yes X No \_\_\_\_\_ Field Plot ID: 20A-SP1  
 Is the site significantly disturbed (Atypical Situation)? Yes \_\_\_\_\_ No X  
 Is the area a potential Problem Area? Yes \_\_\_\_\_ No X

**Remarks** (Explain sample location, disturbances, problem areas):

*This sample plot is located approximately 2 feet east of the edge of the trail just east of the edge of the ditch, approximately 150 feet south of the driveway crossing, across from the 3rd garage door bay on the brown house #1631.*

### VEGETATION (✓ Dominant species are checked)

	Plant Species	% Cover	Stratum	Indicator
1.	<u>Epilobium ciliatum</u>	<u>trace</u>	<u>H</u>	<u>FACW-</u>
2.	<u>Equisetum arvense</u>	<u>10</u>	<u>H</u>	<u>FAC</u>
✓ 3.	<u>Phalaris arundinacea</u>	<u>90</u>	<u>H</u>	<u>FACW</u>
4.	<u>Rubus armeniacus</u>	<u>5</u>	<u>S</u>	<u>FACU</u>

Percent of **Dominant Species** that are OBL, FACW, or FAC (except FAC-). Include species noted (\*) as showing morphological adaptations to wetlands. "T" indicates trace. 100

**Remarks** (Describe disturbances, relevant local variations, seasonal effects, etc.):

*The percent of dominant species that are hydrophytic is greater than 50 percent. Hydrophytic vegetation criterion is satisfied.*

### HYDROLOGY

**Recorded Data** (Describe in Remarks):

\_\_\_\_\_ Stream, Lake, or Tide Gage  
 \_\_\_\_\_ Aerial Photograph  
 \_\_\_\_\_ Other  
X No Recorded Data Available

**Field Observations:**

Depth of Surface Water: none (in.)  
 Depth to Free Water in Pit: none (in.)  
 Depth to Saturated Soil: 5 (in.)

**Wetland Hydrology Indicators** (Describe in Remarks):

Primary Indicators:

\_\_\_\_\_ Inundated  
X Saturated in Upper 12 inches  
 \_\_\_\_\_ Water Marks  
 \_\_\_\_\_ Drift Lines  
 \_\_\_\_\_ Sediment Deposits  
 \_\_\_\_\_ Drainage Patterns in Wetlands

Secondary Indicators (2 or more required):

\_\_\_\_\_ Oxidized Rhizospheres in Upper 12 inches  
 \_\_\_\_\_ Water-Stained Leaves  
 \_\_\_\_\_ Local Soil Survey Data  
 \_\_\_\_\_ Other (Explain in Remarks)

**Remarks** (As relevant, describe recent precipitation, hydrologic modifications, local variations, etc.):

*Saturation in the upper 12 inches satisfies wetland hydrology criterion.*

**09-12-13 Observations** - Saturated at 3 inches below surface.

# Parametrix

Data Plot #: 20A-SP1  
Wetland: 20A

Project/Site: ELST Re-delineation Date: 11/1/2007 Revisited 09-12-13

## SOIL

### Soil Survey Data:

Map Unit Name: Alderwood gravelly sandy loam 6 to 15% slopes Drainage Class: Moderately well drained  
Field Observations Confirm Mapped Type?

Taxonomy (Subgroup): Entic Durochrepts Yes  No  NA

### Profile Description:

Depth (Inches)	Horizon Designation	Matrix Color (Munsell Moist)	Mottle Color (Munsell Moist)	Mottle Abundance/Contrast	Texture, Concretions, Rhizospheres, etc.
0-6	A	10YR 3/1	none	none	silt loam
6-18	A2	10YR 3/1	none	none	gravelly sandy loam

### Hydric Soil Indicators:

- |   |   |
|---|---|
| <input type="checkbox"/> Histosol                               | <input type="checkbox"/> Listed on Hydric Soils List      |
| <input type="checkbox"/> Histic Epipedon                        | <input type="checkbox"/> Fe/Mn Concretions                |
| <input type="checkbox"/> Sulfidic Odor                          | <input type="checkbox"/> Organic Streaking in Sandy Soils |
| <input type="checkbox"/> Aquic or Peraguc Moisture Regime       | <input type="checkbox"/> Mottles (Redoximorphic Features) |
| <input type="checkbox"/> Reducing Conditions                    | <input type="checkbox"/> Other (Explain in Remarks)       |
| <input checked="" type="checkbox"/> Gleyed or Low-Chroma Colors |   |
| <input type="checkbox"/> High Organic Content in Surface Layer  |   |

Remarks (Describe soil disturbances, local variations, etc.):  
*Chroma 1 soil indicate hydric soils.*

## WETLAND DETERMINATION

Hydrophytic Vegetation Present? Yes  No  Is this Sampling Point Within a Wetland?  
Hydric Soils Present? Yes  No  Yes  No   
Wetland Hydrology Present? Yes  No

Remarks  
*Wetland vegetation, hydrology, and soil criteria are met. Therefore, the sample plot is located in a wetland.*



Data Plot #: 20A-SP2  
Wetland: Upland near 20A

## WETLAND DETERMINATION (Modified from: 1987 ACOE Wetlands Delineation Manual)

Project/Site: ELST Re-delineation Date: 11/1/2007 Revisited 09-12-13  
Applicant/Owner: King County County: King  
Investigator: Matt Maynard, Chrissy Bailey State: WA  
 1987 Method  1997 WA St. Method Community ID: Upland Shrub  
Do Normal Circumstances exist on the site? Yes X No \_\_\_\_\_ Field Plot ID: 20A-SP2  
Is the site significantly disturbed (Atypical Situation)? Yes \_\_\_\_\_ No X  
Is the area a potential Problem Area? Yes \_\_\_\_\_ No X

**Remarks** (Explain sample location, disturbances, problem areas):  
*This sample plot is located approximately 20 feet northeast of flag 20A-13.*

### VEGETATION (✓ Dominant species are checked)

Plant Species	% Cover	Stratum	Indicator
1. <u>Phalaris arundinacea</u>	<u>10</u>	<u>H</u>	<u>FACW</u>
✓ 2. <u>Rubus armeniacus</u>	<u>70</u>	<u>S</u>	<u>FACU</u>
✓ 3. <u>Gleditsia triacanthos</u>	<u>45</u>	<u>T</u>	<u>NO</u>

**09-11-13 Observations**  
Phalaris arundinacea 10%  
Rubus armeniacus 70%  
Robinia pseudoacacia 90%  
Rubus ursinus 15%

Percent of **Dominant Species** that are OBL, FACW, or FAC (except FAC-). Include species noted (\*) as showing morphological adaptations to wetlands. "T" indicates trace. 0

**Remarks** (Describe disturbances, relevant local variations, seasonal effects, etc.):  
*The percent of dominant species that are hydrophytic is not greater than 50 percent. Hydrophytic vegetation criterion is not satisfied.*

### HYDROLOGY

**Recorded Data** (Describe in Remarks):

\_\_\_\_\_  
Stream, Lake, or Tide Gage  
\_\_\_\_\_  
Aerial Photograph  
\_\_\_\_\_  
Other  
X  
No Recorded Data Available

**Wetland Hydrology Indicators** (Describe in Remarks):

Primary Indicators:  
\_\_\_\_\_  
Inundated  
\_\_\_\_\_  
Saturated in Upper 12 inches  
\_\_\_\_\_  
Water Marks  
\_\_\_\_\_  
Drift Lines  
\_\_\_\_\_  
Sediment Deposits  
\_\_\_\_\_  
Drainage Patterns in Wetlands

**Field Observations:**

Depth of Surface Water: none (in.)  
Depth to Free Water in Pit: none (in.)  
Depth to Saturated Soil: none (in.)

Secondary Indicators (2 or more required):  
\_\_\_\_\_  
Oxidized Rhizospheres in Upper 12 inches  
\_\_\_\_\_  
Water-Stained Leaves  
\_\_\_\_\_  
Local Soil Survey Data  
\_\_\_\_\_  
Other (Explain in Remarks)

**Remarks** (As relevant, describe recent precipitation, hydrologic modifications, local variations, etc.):  
*No primary or secondary indicators of hydrology are present. Wetland hydrology criterion is not satisfied.*

# Parametrix

Data Plot #: 20A-SP2  
Wetland: Upland near 20A

Project/Site: ELST Re-delineation Date: 11/1/2007 Revisited 09-12-13

## SOIL

### Soil Survey Data:

Map Unit Name: Alderwood gravelly sandy loam 6 to 15% slopes Drainage Class: Moderately well drained  
Field Observations Confirm Mapped Type?

Taxonomy (Subgroup): Entic Durochrepts Yes  No  NA

### Profile Description:

Depth (Inches)	Horizon Designation	Matrix Color (Munsell Moist)	Mottle Color (Munsell Moist)	Mottle Abundance/Contrast	Texture, Concretions, Rhizospheres, etc.
0-7	A	10YR 3/3	none	none	sandy loam
7-18	B	10YR 4/2	none	none	sandy loam

### Hydric Soil Indicators:

- |  |   |
|--|---|
| <input type="checkbox"/> Histosol                              | <input type="checkbox"/> Listed on Hydric Soils List      |
| <input type="checkbox"/> Histic Epipedon                       | <input type="checkbox"/> Fe/Mn Concretions                |
| <input type="checkbox"/> Sulfidic Odor                         | <input type="checkbox"/> Organic Streaking in Sandy Soils |
| <input type="checkbox"/> Aquic or Peraguc Moisture Regime      | <input type="checkbox"/> Mottles (Redoximorphic Features) |
| <input type="checkbox"/> Reducing Conditions                   | <input type="checkbox"/> Other (Explain in Remarks)       |
| <input type="checkbox"/> Gleyed or Low-Chroma Colors           |   |
| <input type="checkbox"/> High Organic Content in Surface Layer |   |

Remarks (Describe soil disturbances, local variations, etc.):  
*No hydric soil indicators are present. Hydric soil criterion is not satisfied.*

## WETLAND DETERMINATION

Hydrophytic Vegetation Present? Yes  No  Is this Sampling Point Within a Wetland?  
Hydric Soils Present? Yes  No  Yes  No   
Wetland Hydrology Present? Yes  No

Remarks  
*Hydrophytic vegetation, hydric soil, and wetland hydrology criteria are not satisfied. Therefore, the sample plot is not located in a wetland.*

# WETLAND DETERMINATION DATA FORM – Western Mountains, Valleys, and Coast Region

Project Site: ELST - South Sammamish Segment City/County: Sammamish/King Sampling Date: 03-19-14  
 Applicant/Owner: King County State: WA Sampling Point: W20B-SP1 (rev)  
 Investigator(s): C. Worsley; K. Seckel Section, Township, Range: S06, T24N, R06E  
 Landform (hillslope, terrace, etc.): flat Local relief (concave, convex, none): none Slope (%): 0%  
 Subregion (LRR): A Lat: \_\_\_\_\_ Long: \_\_\_\_\_ Datum: \_\_\_\_\_  
 Soil Map Unit Name: Alderwood gravelly sandy loam NWI classification: Upland  
 Are climatic / hydrologic conditions on the site typical for this time of year? Yes  No  (If no, explain in Remarks.)  
 Are Vegetation , Soil , or Hydrology , significantly disturbed? Are "Normal Circumstances" present? Yes  No   
 Are Vegetation , Soil , or Hydrology , naturally problematic? (If needed, explain any answers in Remarks.)

### SUMMARY OF FINDINGS – Attach site map showing sampling point locations, transects, important features, etc.

Hydrophytic Vegetation Present?	Yes <input type="checkbox"/>	No <input checked="" type="checkbox"/>	<b>Is the Sampled Area within a Wetland?</b>	Yes <input type="checkbox"/>	No <input checked="" type="checkbox"/>
Hydric Soil Present?	Yes <input checked="" type="checkbox"/>	No <input type="checkbox"/>		Yes <input type="checkbox"/>	No <input checked="" type="checkbox"/>
Wetland Hydrology Present?	Yes <input type="checkbox"/>	No <input checked="" type="checkbox"/>		Yes <input type="checkbox"/>	No <input checked="" type="checkbox"/>
Remarks: Area was previously identified and documented as wetland. Wetland is no longer present with area regraded, landscaped, and hydrologic source (pipe from under trail that conveys water from Wetland 20A and ditches on east side of trail) altered. The outlet to this pipe is no longer visible or apparent. The upgradient side of the pipe (inlet on east side of trail) has a smaller 4-inch white PVC pipe slipped inside. It appears this water is now piped to the lake. New sample plot is located in maintained/landscaped yard approximately 35 feet north (17 deg) of large Douglas fir at north edge of lawn, north of fire pit.					

### VEGETATION – Use scientific names of plants

Tree Stratum (Plot size: <u>30 feet</u> )	Absolute % Cover	Dominant Species?	Indicator Status	Dominance Test Worksheet:																
1. _____	_____	_____	_____	Number of Dominant Species That Are OBL, FACW, or FAC: _____ (A)  Total Number of Dominant Species Across All Strata: _____ (B)  Percent of Dominant Species That Are OBL, FACW, or FAC: _____ (A/B)																
2. _____	_____	_____	_____																	
3. _____	_____	_____	_____																	
4. _____	_____	_____	_____																	
50% = _____, 20% = _____	_____	= Total Cover		<b>Prevalence Index worksheet:</b>  <table style="width: 100%; border: none;"> <tr> <td style="text-align: center;"><u>Total % Cover of:</u></td> <td style="text-align: center;"><u>Multiply by:</u></td> </tr> <tr> <td>OBL species _____</td> <td>x1 = _____</td> </tr> <tr> <td>FACW species _____</td> <td>x2 = _____</td> </tr> <tr> <td>FAC species _____</td> <td>x3 = <b>!! FORMTEXT</b></td> </tr> <tr> <td>FACU species _____</td> <td>x4 = _____</td> </tr> <tr> <td>UPL species _____</td> <td>x5 = _____</td> </tr> <tr> <td>Column Totals: _____ (A)</td> <td>_____ (B)</td> </tr> <tr> <td colspan="2" style="text-align: center;">Prevalence Index = B/A = _____</td> </tr> </table>	<u>Total % Cover of:</u>	<u>Multiply by:</u>	OBL species _____	x1 = _____	FACW species _____	x2 = _____	FAC species _____	x3 = <b>!! FORMTEXT</b>	FACU species _____	x4 = _____	UPL species _____	x5 = _____	Column Totals: _____ (A)	_____ (B)	Prevalence Index = B/A = _____	
<u>Total % Cover of:</u>	<u>Multiply by:</u>																			
OBL species _____	x1 = _____																			
FACW species _____	x2 = _____																			
FAC species _____	x3 = <b>!! FORMTEXT</b>																			
FACU species _____	x4 = _____																			
UPL species _____	x5 = _____																			
Column Totals: _____ (A)	_____ (B)																			
Prevalence Index = B/A = _____																				
<u>Sapling/Shrub Stratum</u> (Plot size: <u>15 feet</u> )																				
1. <u>arbor vitae</u>	<u>15</u>	_____	_____																	
2. <u>boxwood</u>	<u>10</u>	_____	_____																	
3. _____	_____	_____	_____																	
4. _____	_____	_____	_____																	
5. _____	_____	_____	_____																	
50% = _____, 20% = _____	<u>25</u>	= Total Cover																		
<u>Herb Stratum</u> (Plot size: <u>3 feet</u> )																				
1. <u>maintained lawn</u>	<u>60</u>	_____	_____																	
2. _____	_____	_____	_____																	
3. _____	_____	_____	_____																	
4. _____	_____	_____	_____																	
5. _____	_____	_____	_____																	
6. _____	_____	_____	_____																	
7. _____	_____	_____	_____																	
8. _____	_____	_____	_____																	
9. _____	_____	_____	_____																	
10. _____	_____	_____	_____																	
11. _____	_____	_____	_____																	
50% = _____, 20% = _____	<u>60</u>	= Total Cover																		
<u>Woody Vine Stratum</u> (Plot size: <u>NA</u> )																				
1. _____	_____	_____	_____																	
2. _____	_____	_____	_____																	
50% = _____, 20% = _____	_____	= Total Cover																		
% Bare Ground in Herb Stratum <u>30 (bark)</u>																				

**Hydrophytic Vegetation Indicators:**

1 – Rapid Test for Hydrophytic Vegetation

2 - Dominance Test is >50%

3 - Prevalence Index is ≤3.0<sup>1</sup>

4 - Morphological Adaptations<sup>1</sup> (Provide supporting data in Remarks or on a separate sheet)

5 - Wetland Non-Vascular Plants<sup>1</sup>

Problematic Hydrophytic Vegetation<sup>1</sup> (Explain)

<sup>1</sup>Indicators of hydric soil and wetland hydrology must be present, unless disturbed or problematic.

**Hydrophytic Vegetation Present?** Yes  No

Remarks: Area is a landscaped yard, not naturally occurring vegetation.

**SOIL**

Profile Description: (Describe to the depth needed to document the indicator or confirm the absence of indicators.)								
Depth (inches)	Matrix		Redox Features				Texture	Remarks
	Color (moist)	%	Color (moist)	%	Type <sup>1</sup>	Loc <sup>2</sup>		
0-10	10YR 3/2	100					gr. sa. loam	
10-18	10G 6/1	99	10YR 4/4	1	C	M	lo. sand	some gravel
—	—	—	—	—	—	—	—	—
—	—	—	—	—	—	—	—	—
—	—	—	—	—	—	—	—	—
—	—	—	—	—	—	—	—	—
—	—	—	—	—	—	—	—	—

<sup>1</sup>Type: C= Concentration, D=Depletion, RM=Reduced Matrix, CS=Covered or Coated Sand Grains.      <sup>2</sup>Location: PL=Pore Lining, M=Matrix

<b>Hydric Soil Indicators: (Applicable to all LRRs, unless otherwise noted.)</b>			<b>Indicators for Problematic Hydric Soils<sup>3</sup>:</b>		
<input type="checkbox"/> Histosol (A1)	<input type="checkbox"/> Sandy Redox (S5)	<input type="checkbox"/> 2 cm Muck (A10)			
<input type="checkbox"/> Histic Epipedon (A2)	<input type="checkbox"/> Stripped Matrix (S6)	<input type="checkbox"/> Red Parent Material (TF2)			
<input type="checkbox"/> Black Histic (A3)	<input type="checkbox"/> Loamy Mucky Mineral (F1) <b>(except MLRA 1)</b>	<input type="checkbox"/> Very Shallow Dark Surface (TF12)			
<input type="checkbox"/> Hydrogen Sulfide (A4)	<input type="checkbox"/> Loamy Gleyed Matrix (F2)	<input type="checkbox"/> Other (Explain in Remarks)			
<input type="checkbox"/> Depleted Below Dark Surface (A11)	<input type="checkbox"/> Depleted Matrix (F3)				
<input type="checkbox"/> Thick Dark Surface (A12)	<input type="checkbox"/> Redox Dark Surface (F6)				
<input type="checkbox"/> Sandy Mucky Mineral (S1)	<input type="checkbox"/> Depleted Dark Surface (F7)				
<input checked="" type="checkbox"/> Sandy Gleyed Matrix (S4)	<input type="checkbox"/> Redox Depressions (F8)				

<sup>3</sup>Indicators of hydrophytic vegetation and wetland hydrology must be present, unless disturbed or problematic.

<b>Restrictive Layer (if present):</b>	<b>Hydric Soils Present?</b>	Yes	<input checked="" type="checkbox"/>	No	<input type="checkbox"/>
Type: _____					
Depth (inches): _____					

Remarks:

**HYDROLOGY**

<b>Wetland Hydrology Indicators:</b>			
Primary Indicators (minimum of one required; check all that apply)		Secondary Indicators (2 or more required)	
<input type="checkbox"/> Surface Water (A1)	<input type="checkbox"/> Water-Stained Leaves (B9)	<input type="checkbox"/> Water-Stained Leaves (B9)	
<input type="checkbox"/> High Water Table (A2)	<b>(except MLRA 1, 2, 4A, and 4B)</b>	<b>(MLRA 1, 2, 4A, and 4B)</b>	
<input type="checkbox"/> Saturation (A3)	<input type="checkbox"/> Salt Crust (B11)	<input type="checkbox"/> Drainage Patterns (B10)	
<input type="checkbox"/> Water Marks (B1)	<input type="checkbox"/> Aquatic Invertebrates (B13)	<input type="checkbox"/> Dry-Season Water Table (C2)	
<input type="checkbox"/> Sediment Deposits (B2)	<input type="checkbox"/> Hydrogen Sulfide Odor (C1)	<input type="checkbox"/> Saturation Visible on Aerial Imagery (C9)	
<input type="checkbox"/> Drift Deposits (B3)	<input type="checkbox"/> Oxidized Rhizospheres along Living Roots (C3)	<input type="checkbox"/> Geomorphic Position (D2)	
<input type="checkbox"/> Algal Mat or Crust (B4)	<input type="checkbox"/> Presence of Reduced Iron (C4)	<input type="checkbox"/> Shallow Aquitard (D3)	
<input type="checkbox"/> Iron Deposits (B5)	<input type="checkbox"/> Recent Iron Reduction in Tilled Soils (C6)	<input type="checkbox"/> FAC-Neutral Test (D5)	
<input type="checkbox"/> Surface Soil Cracks (B6)	<input type="checkbox"/> Stunted or Stresses Plants (D1) <b>(LRR A)</b>	<input type="checkbox"/> Raised Ant Mounds (D6) <b>(LRR A)</b>	
<input type="checkbox"/> Inundation Visible on Aerial Imagery (B7)	<input type="checkbox"/> Other (Explain in Remarks)	<input type="checkbox"/> Frost-Heave Hummocks (D7)	
<input type="checkbox"/> Sparsely Vegetated Concave Surface (B8)			

<b>Field Observations:</b>			
Surface Water Present?	Yes <input type="checkbox"/> No <input checked="" type="checkbox"/>	Depth (inches): _____	<b>Wetland Hydrology Present?</b> Yes <input type="checkbox"/> No <input checked="" type="checkbox"/>
Water Table Present?	Yes <input type="checkbox"/> No <input checked="" type="checkbox"/>	Depth (inches): _____	
Saturation Present? (includes capillary fringe)	Yes <input type="checkbox"/> No <input checked="" type="checkbox"/>	Depth (inches): _____	

Describe Recorded Data (stream gauge, monitoring well, aerial photos, previous inspections), if available:

Remarks:      No primary or secondary indicators of wetland hydrology observed.

**Exhibit 16**  
**SSDP2016-00415**

Data Plot #: 21A-SP1  
 Wetland: 21A

## WETLAND DETERMINATION (Modified from: 1987 ACOE Wetlands Delineation Manual)

Project/Site: ELST Re-delineation Date: 10/31/2007 Revisited 03-19-14  
 Applicant/Owner: King County County: King County  
 Investigator: Michael Muscari/Laura Brock State: WA  
 1987 Method  1997 WA St. Method Community ID: PEM  
 Do Normal Circumstances exist on the site? Yes X No        Field Plot ID: 21A-SP1  
 Is the site significantly disturbed (Atypical Situation)? Yes X No         
 Is the area a potential Problem Area? Yes        No X

**Remarks** (Explain sample location, disturbances, problem areas):

*Combined wetlands 21A with 21C. This sample plot is located near the toe of slope between shrubs and mowed lawn, approximately 5' north of flag 4.*  
*Flags W21A 1-15.* Concave, approximately 8% slope

**VEGETATION** (✓ Dominant species are checked)

Plant Species	% Cover	Stratum	Indicator
1. <u>Cornus sericea</u>	<u>5</u>	<u>Herb</u>	<u>FACW</u>
2. <u>Holcus lanatus</u>	<u>2</u>	<u>Herb</u>	<u>FAC</u>
✓ 3. <u>lawn grass (mowed)</u>	<u>40</u>	<u>Herb</u>	<u>UNK</u>
4. <u>Myosotis scorpioides</u>	<u>10</u>	<u>Herb</u>	<u>FACW</u>
✓ 5. <u>Ranunculus repens</u>	<u>30</u>	<u>Herb</u>	<u>FACW</u>
6. <u>Rubus spectabilis</u>	<u>10</u>	<u>Herb</u>	<u>FAC+</u>

**03-19-14 Observations**

Cornus sericea 5%  
 Oemleria cerasiformis 10%  
 Rubus spectabilis 10%  
 Holcus lanatus 2%  
 lawn grass (mowed) 40%  
 Myosotis scorpioides 10%  
 Ranunculus repens 30%  
 Hedera helix 2%  
 Athyrium filix-femina 15%  
 Equisetum telmateia 2%  
 moss 30%

Percent of **Dominant Species** that are OBL, FACW, or FAC (except FAC-). Include species noted (\*) as showing morphological adaptations to wetlands. "T" indicates trace. 100

**Remarks** (Describe disturbances, relevant local variations, seasonal effects, etc.):

*Scirpus microcarpus is interspersed and mowed in lawn. A small aquatic bed is present in the lake. The percent of dominant species that are hydrophytic is greater than 50 percent. Hydrophytic vegetation criterion is satisfied.*

**HYDROLOGY**

**Recorded Data** (Describe in Remarks):

       Stream, Lake, or Tide Gage  
       Aerial Photograph  
       Other  
X No Recorded Data Available

**Wetland Hydrology Indicators** (Describe in Remarks):

Primary Indicators:  
       Inundated  
X Saturated in Upper 12 inches  
       Water Marks  
       Drift Lines  
       Sediment Deposits  
       Drainage Patterns in Wetlands

**Field Observations:**

Depth of Surface Water: none (in.)  
 Depth to Free Water in Pit: none (in.)  
 Depth to Saturated Soil: 4 (in.)

Secondary Indicators (2 or more required):  
       Oxidized Rhizospheres in Upper 12 inches  
       Water-Stained Leaves  
       Local Soil Survey Data  
       Other (Explain in Remarks)

**Remarks** (As relevant, describe recent precipitation, hydrologic modifications, local variations, etc.):

*Soil saturation in the upper 12 inches satisfies wetland hydrology criterion.*

**03-19-14 Observations** - Saturated at surface. Free water in pit at 12 inches below surface.

# Parametrix

Data Plot #: 21A-SP1  
 Wetland: 21A

Project/Site: ELST Re-delineation Date: 10/31/2007 Revisited 03-19-14

## SOIL

### Soil Survey Data:

Map Unit Name: Alderwood gravelly sandy loam, 15 to 30 % slopes Drainage Class: Moderately well drained  
 Field Observations Confirm Mapped Type?

Taxonomy (Subgroup): Entic Durochrepts Yes  No  NA

### Profile Description:

Depth (Inches)	Horizon Designation	Matrix Color (Munsell Moist)	Mottle Color (Munsell Moist)	Mottle Abundance/Contrast	Texture, Concretions, Rhizospheres, etc.
0-4	A	10YR 3/1	none	none	sandy loam
4-10	B1	10YR 5/1	7.5YR 4/6	many, prominent	loamy sand
10-16	B2	gley	none	none	sand

### Hydric Soil Indicators:

- |  |  |
|--|--|
| <input type="checkbox"/> Histosol                          | <input type="checkbox"/> Listed on Hydric Soils List                 |
| <input type="checkbox"/> Histic Epipedon                   | <input type="checkbox"/> Fe/Mn Concretions                           |
| <input type="checkbox"/> Sulfidic Odor                     | <input type="checkbox"/> Organic Streaking in Sandy Soils            |
| <input type="checkbox"/> Aquic or Peraguic Moisture Regime | <input checked="" type="checkbox"/> Mottles (Redoximorphic Features) |
| <input type="checkbox"/> Reducing Conditions               | <input type="checkbox"/> Other (Explain in Remarks)                  |

<input checked="" type="checkbox"/> Gleyed or Low-Chroma Colors	<b>03-19-14 Observations</b> -	0-4	10YR 3/1	none	none	sa. loam
<input type="checkbox"/> High Organic Content in Surface Layer		4-9	10YR 5/1	7.5YR 4/6		lo. sand
		9-16	10Y 4/1	none	none	gr. sand

Remarks (Describe soil disturbances, local variations, etc.):

*Low chroma soil matrix with redoximorphic features is present below the A-horizon. Hydric soils criterion is satisfied.*

## WETLAND DETERMINATION

Hydrophytic Vegetation Present? Yes  No  Is this Sampling Point Within a Wetland?  
 Hydric Soils Present? Yes  No  Yes  No   
 Wetland Hydrology Present? Yes  No

### Remarks

*Wetland vegetation, hydrology, and soil criteria are satisfied. Therefore, the sample plot is located in a wetland.*

Data Plot #: 21A-SP2  
 Wetland: Upland near 21A

## WETLAND DETERMINATION (Modified from: 1987 ACOE Wetlands Delineation Manual)

Project/Site: ELST Re-delineation Date: 10/31/2007 Revisited 03-19-14  
 Applicant/Owner: King County County: King County  
 Investigator: Michael Muscari, Laura Brock State: WA  
 1987 Method  1997 WA St. Method Community ID: Upland Shrub  
 Do Normal Circumstances exist on the site? Yes X No \_\_\_\_\_ Field Plot ID: 21A-SP2  
 Is the site significantly disturbed (Atypical Situation)? Yes \_\_\_\_\_ No X  
 Is the area a potential Problem Area? Yes \_\_\_\_\_ No X

**Remarks** (Explain sample location, disturbances, problem areas):  
*This sample plot is approximately 5' south of flag 4 and 3 feet higher in elevation than 21A-SP-1*

### VEGETATION (✓ Dominant species are checked)

Plant Species	% Cover	Stratum	Indicator
1. <u>Equisetum telmateia</u>	<u>5</u>	<u>Herb</u>	<u>FACW</u>
2. <u>Geranium robertianum</u>	<u>2</u>	<u>Herb</u>	<u>NL</u>
✓ 3. <u>Polystichum munitum</u>	<u>20</u>	<u>Herb</u>	<u>FACU</u>
4. <u>Pteridium aquilinum</u>	<u>5</u>	<u>Herb</u>	<u>FACU</u>
5. <u>Urtica dioica</u>	<u>2</u>	<u>Herb</u>	<u>FAC+</u>
✓ 6. <u>Corylus cornuta</u>	<u>75</u>	<u>Shrub</u>	<u>FACU</u>
✓ 7. <u>Rubus spectabilis</u>	<u>40</u>	<u>Shrub</u>	<u>FAC+</u>
8. <u>Rubus ursinus</u>	<u>10</u>	<u>Shrub</u>	<u>FACU</u>

**03-19-14 Observations**  
 Corylus cornuta 75%  
 Oemleria cerasiformis 5%  
 Rubus spectabilis 40%  
 Rubus ursinus 10%  
 Equisetum telmateia 5%  
 Geranium robertianum 2%  
 Polystichum munitum 20%  
 Pteridium aquilinum 5%  
 Urtica dioica 2%

Percent of **Dominant Species** that are OBL, FACW, or FAC (except FAC-). Include species noted (\*) as showing morphological adaptations to wetlands. "T" indicates trace. 33

**Remarks** (Describe disturbances, relevant local variations, seasonal effects, etc.):  
*Corylus cornuta, Rubus spectabilis are dominant in undisturbed upland areas. Adjacent uplands are mowed, maintained lawn. The percent of dominant species that are hydrophytic is not greater than 50 percent. Hydrophytic vegetation criterion is not satisfied.*

### HYDROLOGY

**Recorded Data** (Describe in Remarks):  
 \_\_\_\_\_ Stream, Lake, or Tide Gage  
 \_\_\_\_\_ Aerial Photograph  
 \_\_\_\_\_ Other  
X No Recorded Data Available

**Wetland Hydrology Indicators** (Describe in Remarks):  
 Primary Indicators:

- \_\_\_\_\_ Inundated
- \_\_\_\_\_ Saturated in Upper 12 inches
- \_\_\_\_\_ Water Marks
- \_\_\_\_\_ Drift Lines
- \_\_\_\_\_ Sediment Deposits
- \_\_\_\_\_ Drainage Patterns in Wetlands

**Field Observations:**

Depth of Surface Water: none (in.)  
 Depth to Free Water in Pit: none (in.)  
 Depth to Saturated Soil: none (in.)

- Secondary Indicators (2 or more required):
- \_\_\_\_\_ Oxidized Rhizospheres in Upper 12 inches
  - \_\_\_\_\_ Water-Stained Leaves
  - \_\_\_\_\_ Local Soil Survey Data
  - \_\_\_\_\_ Other (Explain in Remarks)

**Remarks** (As relevant, describe recent precipitation, hydrologic modifications, local variations, etc.):  
*Dry to 16". No primary or secondary indicators of hydrology are present. Wetland hydrology criterion is not satisfied.*

**03-19-14 Observations** - No primary or secondary hydrology indicators observed.

# Parametrix

Data Plot #: 21A-SP2  
Wetland: Upland near 21A

Project/Site: ELST Re-delineation Date: 10/31/2007 Revisited 03-19-14

## SOIL

### Soil Survey Data:

Map Unit Name: Alderwood gravelly sandy loam, 15 to 30 % slopes Drainage Class: Moderately well drained  
Field Observations Confirm Mapped Type?

Taxonomy (Subgroup): Entic Durochrepts Yes  No  NA

### Profile Description:

Depth (Inches)	Horizon Designation	Matrix Color (Munsell Moist)	Mottle Color (Munsell Moist)	Mottle Abundance/Contrast	Texture, Concretions, Rhizospheres, etc.
0-15	A	10YR 2/1	none	none	gravelly sandy loam
15-16	B	10YR 4/3	none	none	loamy sand

**03-19-14 Observations - 0-18**    10YR 3/2    none    none    gr. sa. loam

### Hydric Soil Indicators:

- |   |   |
|---|---|
| <input type="checkbox"/> Histosol                               | <input type="checkbox"/> Listed on Hydric Soils List      |
| <input type="checkbox"/> Histic Epipedon                        | <input type="checkbox"/> Fe/Mn Concretions                |
| <input type="checkbox"/> Sulfidic Odor                          | <input type="checkbox"/> Organic Streaking in Sandy Soils |
| <input type="checkbox"/> Aquic or Peraguc Moisture Regime       | <input type="checkbox"/> Mottles (Redoximorphic Features) |
| <input type="checkbox"/> Reducing Conditions                    | <input type="checkbox"/> Other (Explain in Remarks)       |
| <input checked="" type="checkbox"/> Gleyed or Low-Chroma Colors |   |
| <input type="checkbox"/> High Organic Content in Surface Layer  |   |

**Remarks** (Describe soil disturbances, local variations, etc.):  
*Low chroma soil matrix indicates hydric soil. Hydric soil criterion is satisfied.*

## WETLAND DETERMINATION

Hydrophytic Vegetation Present?    Yes  No     **Is this Sampling Point Within a Wetland?**  
Hydric Soils Present?    Yes  No     Yes  No   
Wetland Hydrology Present?    Yes  No

**Remarks**  
*Hydrophytic vegetation and wetland hydrology criteria are not satisfied. The sample plot is not located in a wetland.*



Data Plot #: 21B-SP1  
 Wetland: 21B

## WETLAND DETERMINATION (Modified from: 1987 ACOE Wetlands Delineation Manual)

Project/Site: ELST Re-delineation Date: 11/1/2007 Revisited 09-12-13  
 Applicant/Owner: King County County: King  
 Investigator: Matt Maynard, Chrissy Bailey State: WA  
 1987 Method  1997 WA St. Method Community ID: PFO  
 Do Normal Circumstances exist on the site? Yes X No \_\_\_\_\_ Field Plot ID: 21B-SP1  
 Is the site significantly disturbed (Atypical Situation)? Yes \_\_\_\_\_ No X  
 Is the area a potential Problem Area? Yes \_\_\_\_\_ No X

**Remarks** (Explain sample location, disturbances, problem areas):  
*This sample plot is located in the center of the wetland approximately 20 feet southeast of flag 21B-9*

### VEGETATION (✓ Dominant species are checked)

	Plant Species	% Cover	Stratum	Indicator
1.	<u>Equisetum telmateia</u>	<u>trace</u>	<u>H</u>	<u>FACW</u>
2.	<u>Phalaris arundinacea</u>	<u>5</u>	<u>H</u>	<u>FACW</u>
3.	<u>Solanum dulcamara</u>	<u>10</u>	<u>H</u>	<u>FAC+</u>
4.	<u>Urtica dioica</u>	<u>10</u>	<u>H</u>	<u>FAC+</u>
✓ 5.	<u>Corylus cornuta</u>	<u>20</u>	<u>S</u>	<u>FACU</u>
6.	<u>Ribes divaricatum</u>	<u>5</u>	<u>S</u>	<u>NI</u>
7.	<u>Rubus armeniacus</u>	<u>10</u>	<u>S</u>	<u>FACU</u>
✓ 8.	<u>Rubus spectabilis</u>	<u>60</u>	<u>S</u>	<u>FAC+</u>
✓ 9.	<u>Alnus rubra</u>	<u>40</u>	<u>T</u>	<u>FAC</u>

Percent of **Dominant Species** that are OBL, FACW, or FAC (except FAC-). Include species noted (\*) as showing morphological adaptations to wetlands. "T" indicates trace. 67

**Remarks** (Describe disturbances, relevant local variations, seasonal effects, etc.):  
*The percent of dominant species that are hydrophytic is greater than 50 percent. Hydrophytic vegetation criterion is satisfied.*

### HYDROLOGY

**Recorded Data** (Describe in Remarks):  
 \_\_\_\_\_ Stream, Lake, or Tide Gage  
 \_\_\_\_\_ Aerial Photograph  
 \_\_\_\_\_ Other  
X No Recorded Data Available

**Wetland Hydrology Indicators** (Describe in Remarks):

Primary Indicators:  
 \_\_\_\_\_ Inundated  
X Saturated in Upper 12 inches  
 \_\_\_\_\_ Water Marks  
 \_\_\_\_\_ Drift Lines  
 \_\_\_\_\_ Sediment Deposits  
 \_\_\_\_\_ Drainage Patterns in Wetlands

**Field Observations:**

Depth of Surface Water: none (in.)  
 Depth to Free Water in Pit: none (in.)  
 Depth to Saturated Soil: surface (in.)

Secondary Indicators (2 or more required):  
 \_\_\_\_\_ Oxidized Rhizospheres in Upper 12 inches  
 \_\_\_\_\_ Water-Stained Leaves  
 \_\_\_\_\_ Local Soil Survey Data  
 \_\_\_\_\_ Other (Explain in Remarks)

**Remarks** (As relevant, describe recent precipitation, hydrologic modifications, local variations, etc.):  
*Saturation in the upper 12 inches satisfies wetland hydrology criterion.*

**09-12-13 Observations** - Inundation observed in ditch within wetland.

# Parametrix

Data Plot #: 21B-SP1  
Wetland: 21B

Project/Site: ELST Re-delineation Date: 11/1/2007 Revisited 09-12-13

## SOIL

### Soil Survey Data:

Map Unit Name: Alderwood gravelly sandy loam 6 to 15% slopes Drainage Class: Moderately well drained  
Field Observations Confirm Mapped Type?

Taxonomy (Subgroup): Entic Durochrepts Yes  No  NA

### Profile Description:

Depth (Inches)	Horizon Designation	Matrix Color (Munsell Moist)	Mottle Color (Munsell Moist)	Mottle Abundance/Contrast	Texture, Concretions, Rhizospheres, etc.
0-18	A	10YR 2/1	none	none	silt loam

### Hydric Soil Indicators:

- |   |   |
|---|---|
| <input type="checkbox"/> Histosol                               | <input type="checkbox"/> Listed on Hydric Soils List      |
| <input type="checkbox"/> Histic Epipedon                        | <input type="checkbox"/> Fe/Mn Concretions                |
| <input type="checkbox"/> Sulfidic Odor                          | <input type="checkbox"/> Organic Streaking in Sandy Soils |
| <input type="checkbox"/> Aquic or Peraguc Moisture Regime       | <input type="checkbox"/> Mottles (Redoximorphic Features) |
| <input type="checkbox"/> Reducing Conditions                    | <input type="checkbox"/> Other (Explain in Remarks)       |
| <input checked="" type="checkbox"/> Gleyed or Low-Chroma Colors |   |
| <input type="checkbox"/> High Organic Content in Surface Layer  |   |

Remarks (Describe soil disturbances, local variations, etc.):  
*Chroma 1 soil indicate hydric soils.*

## WETLAND DETERMINATION

Hydrophytic Vegetation Present? Yes  No  Is this Sampling Point Within a Wetland?  
Hydric Soils Present? Yes  No  Yes  No   
Wetland Hydrology Present? Yes  No

### Remarks

*Wetland vegetation, hydrology, and soil criteria are met. Therefore, the sample plot is located in a wetland.*

Data Plot #: 21B-SP2  
Wetland: Upland near 21B

## WETLAND DETERMINATION (Modified from: 1987 ACOE Wetlands Delineation Manual)

Project/Site: ELST Re-delineation Date: 11/1/2007 Revisited 09-12-13  
Applicant/Owner: King County County: King  
Investigator: Matt Maynard, Chrissy Bailey State: WA  
 1987 Method  1997 WA St. Method Community ID: Upland Forest  
Do Normal Circumstances exist on the site? Yes X No \_\_\_\_\_ Field Plot ID: 21B-SP2  
Is the site significantly disturbed (Atypical Situation)? Yes \_\_\_\_\_ No X  
Is the area a potential Problem Area? Yes \_\_\_\_\_ No X

**Remarks** (Explain sample location, disturbances, problem areas):  
*This sample plot is located approximately 6 feet southeast of flag 21B-1.*

### VEGETATION (✓ Dominant species are checked)

	Plant Species	% Cover	Stratum	Indicator
1.	<u>Equisetum telmateia</u>	<u>trace</u>	<u>H</u>	<u>FACW</u>
2.	<u>Geranium robertianum</u>	<u>trace</u>	<u>H</u>	<u>NL</u>
✓ 3.	<u>Polystichum munitum</u>	<u>40</u>	<u>H</u>	<u>FACU</u>
4.	<u>Rubus ursinus</u>	<u>trace</u>	<u>H</u>	<u>FACU</u>
5.	<u>Urtica dioica</u>	<u>trace</u>	<u>H</u>	<u>FAC+</u>
✓ 6.	<u>Corylus cornuta</u>	<u>55</u>	<u>S</u>	<u>FACU</u>
7.	<u>Rubus spectabilis</u>	<u>10</u>	<u>S</u>	<u>FAC+</u>
✓ 8.	<u>Fraxinus latifolia</u>	<u>75</u>	<u>T</u>	<u>FACW</u>

Percent of **Dominant Species** that are OBL, FACW, or FAC (except FAC-). Include species noted (\*) as showing morphological adaptations to wetlands. "T" indicates trace. 33

**Remarks** (Describe disturbances, relevant local variations, seasonal effects, etc.):  
*The percent of dominant species that are hydrophytic is not greater than 50 percent. Hydrophytic vegetation criterion is not satisfied.*

### HYDROLOGY

**Recorded Data** (Describe in Remarks):

\_\_\_\_\_  
Stream, Lake, or Tide Gage  
\_\_\_\_\_  
Aerial Photograph  
\_\_\_\_\_  
Other  
X  
No Recorded Data Available

**Field Observations:**

Depth of Surface Water: none (in.)  
Depth to Free Water in Pit: none (in.)  
Depth to Saturated Soil: 11 (in.)

**Wetland Hydrology Indicators** (Describe in Remarks):

Primary Indicators:

\_\_\_\_\_  
Inundated  
X  
Saturated in Upper 12 inches  
\_\_\_\_\_  
Water Marks  
\_\_\_\_\_  
Drift Lines  
\_\_\_\_\_  
Sediment Deposits  
\_\_\_\_\_  
Drainage Patterns in Wetlands

Secondary Indicators (2 or more required):

\_\_\_\_\_  
Oxidized Rhizospheres in Upper 12 inches  
\_\_\_\_\_  
Water-Stained Leaves  
\_\_\_\_\_  
Local Soil Survey Data  
\_\_\_\_\_  
Other (Explain in Remarks)

**Remarks** (As relevant, describe recent precipitation, hydrologic modifications, local variations, etc.):  
*Saturation in the upper 12 inches satisfies wetland hydrology criterion.*

# Parametrix

Data Plot #: 21B-SP2  
Wetland: Upland near 21B

Project/Site: ELST Re-delineation Date: 11/1/2007 Revisited 09-12-13

## SOIL

### Soil Survey Data:

Map Unit Name: Alderwood gravelly sandy loam 6 to 15% slopes Drainage Class: Moderately well drained  
Field Observations Confirm Mapped Type?

Taxonomy (Subgroup): Entic Durochrepts Yes  No  NA

### Profile Description:

Depth (Inches)	Horizon Designation	Matrix Color (Munsell Moist)	Mottle Color (Munsell Moist)	Mottle Abundance/Contrast	Texture, Concretions, Rhizospheres, etc.
0-16	A	10YR 2/1	none	none	silt loam

### Hydric Soil Indicators:

- |   |   |
|---|---|
| <input type="checkbox"/> Histosol                               | <input type="checkbox"/> Listed on Hydric Soils List      |
| <input type="checkbox"/> Histic Epipedon                        | <input type="checkbox"/> Fe/Mn Concretions                |
| <input type="checkbox"/> Sulfidic Odor                          | <input type="checkbox"/> Organic Streaking in Sandy Soils |
| <input type="checkbox"/> Aquic or Peraguc Moisture Regime       | <input type="checkbox"/> Mottles (Redoximorphic Features) |
| <input type="checkbox"/> Reducing Conditions                    | <input type="checkbox"/> Other (Explain in Remarks)       |
| <input checked="" type="checkbox"/> Gleyed or Low-Chroma Colors |   |
| <input type="checkbox"/> High Organic Content in Surface Layer  |   |

Remarks (Describe soil disturbances, local variations, etc.):  
*Chroma 1 soil indicate hydric soils.*

## WETLAND DETERMINATION

Hydrophytic Vegetation Present? Yes  No  Is this Sampling Point Within a Wetland?  
Hydric Soils Present? Yes  No  Yes  No   
Wetland Hydrology Present? Yes  No

### Remarks

*Hydrophytic vegetation criterion is not satisfied. Therefore, the sample plot is not located in a wetland.*

# WETLAND DETERMINATION DATA FORM – Western Mountains, Valleys, and Coast Region

Project Site: ELST - South Sammamish Segment City/County: Sammamish/King Sampling Date: 03-19-14  
 Applicant/Owner: King County State: WA Sampling Point: W21D-SP1 (rev)  
 Investigator(s): C. Worsley; K. Seckel Section, Township, Range: S06, T24N, R06E  
 Landform (hillslope, terrace, etc.): gradual slope Local relief (concave, convex, none): convex Slope (%): 5%  
 Subregion (LRR): A Lat: \_\_\_\_\_ Long: \_\_\_\_\_ Datum: \_\_\_\_\_  
 Soil Map Unit Name: Alderwood gravelly sandy loam NWI classification: PEM  
 Are climatic / hydrologic conditions on the site typical for this time of year? Yes  No  (If no, explain in Remarks.)  
 Are Vegetation , Soil , or Hydrology , significantly disturbed? Are "Normal Circumstances" present? Yes  No   
 Are Vegetation , Soil , or Hydrology , naturally problematic? (If needed, explain any answers in Remarks.)

### SUMMARY OF FINDINGS – Attach site map showing sampling point locations, transects, important features, etc.

Hydrophytic Vegetation Present?	Yes <input checked="" type="checkbox"/>	No <input type="checkbox"/>	<b>Is the Sampled Area within a Wetland?</b>	Yes <input checked="" type="checkbox"/>	No <input type="checkbox"/>
Hydric Soil Present?	Yes <input checked="" type="checkbox"/>	No <input type="checkbox"/>		Yes <input checked="" type="checkbox"/>	No <input type="checkbox"/>
Wetland Hydrology Present?	Yes <input checked="" type="checkbox"/>	No <input type="checkbox"/>		Yes <input checked="" type="checkbox"/>	No <input type="checkbox"/>
Remarks: New sample plot was documented because the old location for SP1 has been landscaped. This sample plot is located in maintained lawn approximately 8 feet north (10 deg) from north end of row of lilac and 3 feet sotheast of ditch.					

### VEGETATION – Use scientific names of plants

Tree Stratum (Plot size: 30 feet)	Absolute % Cover	Dominant Species?	Indicator Status	Dominance Test Worksheet:																
1. _____	_____	_____	_____	Number of Dominant Species That Are OBL, FACW, or FAC: _____ (A)  Total Number of Dominant Species Across All Strata: _____ (B)  Percent of Dominant Species That Are OBL, FACW, or FAC: _____ (A/B)																
2. _____	_____	_____	_____																	
3. _____	_____	_____	_____																	
4. _____	_____	_____	_____																	
50% = _____, 20% = _____	_____	= Total Cover		<b>Prevalence Index worksheet:</b>  <table style="width: 100%; border: none;"> <tr> <td style="text-align: center;">Total % Cover of:</td> <td style="text-align: center;">Multiply by:</td> </tr> <tr> <td>OBL species _____</td> <td>x1 = _____</td> </tr> <tr> <td>FACW species _____</td> <td>x2 = _____</td> </tr> <tr> <td>FAC species _____</td> <td>x3 = _____</td> </tr> <tr> <td>FACU species _____</td> <td>x4 = _____</td> </tr> <tr> <td>UPL species _____</td> <td>x5 = _____</td> </tr> <tr> <td>Column Totals: _____ (A)</td> <td>_____ (B)</td> </tr> <tr> <td colspan="2" style="text-align: center;">Prevalence Index = B/A = _____</td> </tr> </table>	Total % Cover of:	Multiply by:	OBL species _____	x1 = _____	FACW species _____	x2 = _____	FAC species _____	x3 = _____	FACU species _____	x4 = _____	UPL species _____	x5 = _____	Column Totals: _____ (A)	_____ (B)	Prevalence Index = B/A = _____	
Total % Cover of:	Multiply by:																			
OBL species _____	x1 = _____																			
FACW species _____	x2 = _____																			
FAC species _____	x3 = _____																			
FACU species _____	x4 = _____																			
UPL species _____	x5 = _____																			
Column Totals: _____ (A)	_____ (B)																			
Prevalence Index = B/A = _____																				
<b>Sapling/Shrub Stratum (Plot size: 15 feet)</b>																				
1. _____	_____	_____	_____																	
2. _____	_____	_____	_____																	
3. _____	_____	_____	_____																	
4. _____	_____	_____	_____																	
5. _____	_____	_____	_____																	
50% = _____, 20% = _____	_____	= Total Cover																		
<b>Herb Stratum (Plot size: 3 feet)</b>																				
1. <u>maintained lawn</u>	<u>95</u>	<u>yes</u>	<u>:</u>																	
2. <u>Scirpus microcarpus</u>	<u>15</u>	<u>no</u>	<u>OBL</u>																	
3. <u>Phalaris arundinacea</u>	<u>10</u>	<u>no</u>	<u>FACW</u>																	
4. <u>Ranunculus repens</u>	<u>5</u>	<u>no</u>	<u>FAC</u>																	
5. _____	_____	_____	_____																	
6. _____	_____	_____	_____																	
7. _____	_____	_____	_____																	
8. _____	_____	_____	_____																	
9. _____	_____	_____	_____																	
10. _____	_____	_____	_____																	
11. _____	_____	_____	_____																	
50% = <u>62.5</u> , 20% = <u>25</u>	<u>125</u>	= Total Cover																		
<b>Woody Vine Stratum (Plot size: NA)</b>																				
1. _____	_____	_____	_____																	
2. _____	_____	_____	_____																	
50% = _____, 20% = _____	_____	= Total Cover																		
<table style="width: 100%; border: none;"> <tr> <td style="width: 35%;"><b>Hydrophytic Vegetation Present?</b></td> <td style="width: 10%;">Yes <input checked="" type="checkbox"/></td> <td style="width: 10%;">No <input type="checkbox"/></td> </tr> </table>				<b>Hydrophytic Vegetation Present?</b>	Yes <input checked="" type="checkbox"/>	No <input type="checkbox"/>														
<b>Hydrophytic Vegetation Present?</b>	Yes <input checked="" type="checkbox"/>	No <input type="checkbox"/>																		
<table style="width: 100%; border: none;"> <tr> <td style="width: 35%;"><b>Hydrophytic Vegetation Present?</b></td> <td style="width: 10%;">Yes <input checked="" type="checkbox"/></td> <td style="width: 10%;">No <input type="checkbox"/></td> </tr> </table>				<b>Hydrophytic Vegetation Present?</b>	Yes <input checked="" type="checkbox"/>	No <input type="checkbox"/>														
<b>Hydrophytic Vegetation Present?</b>	Yes <input checked="" type="checkbox"/>	No <input type="checkbox"/>																		
% Bare Ground in Herb Stratum <u>0</u>																				

Remarks: Although not dominant, naturally occurring vegetation identified within the lawn are all wetland plants with a FAC or wetter indicator status. Observed grass species in the lawn include Agrostis sp., Poa sp., and Festuca rubra. Both hydric soils and wetland hydrology criteria are met.

**SOIL**

**Profile Description: (Describe to the depth needed to document the indicator or confirm the absence of indicators.)**

Depth (inches)	Matrix		Redox Features				Texture	Remarks
	Color (moist)	%	Color (moist)	%	Type <sup>1</sup>	Loc <sup>2</sup>		
0-6	10YR 3/2	75	2.5YR 4/6	25	C	M	loam	
6-12	2.5Y 4/2	70	2.5 YR 4/3	30	C	M	sa. loam	
12-16	2.5Y 4/1	75	2.5YR 2.5/4	25	C	M	lo. sand	
_____	_____	_____	_____	_____	_____	_____	_____	_____
_____	_____	_____	_____	_____	_____	_____	_____	_____
_____	_____	_____	_____	_____	_____	_____	_____	_____
_____	_____	_____	_____	_____	_____	_____	_____	_____

<sup>1</sup>Type: C= Concentration, D=Depletion, RM=Reduced Matrix, CS=Covered or Coated Sand Grains. <sup>2</sup>Location: PL=Pore Lining, M=Matrix

**Hydric Soil Indicators: (Applicable to all LRRs, unless otherwise noted.)**

**Indicators for Problematic Hydric Soils<sup>3</sup>:**

- |  |  |   |
|--|--|---|
| <input type="checkbox"/> Histosol (A1)                     | <input type="checkbox"/> Sandy Redox (S5)                                | <input type="checkbox"/> 2 cm Muck (A10)                  |
| <input type="checkbox"/> Histic Epipedon (A2)              | <input type="checkbox"/> Stripped Matrix (S6)                            | <input type="checkbox"/> Red Parent Material (TF2)        |
| <input type="checkbox"/> Black Histic (A3)                 | <input type="checkbox"/> Loamy Mucky Mineral (F1) <b>(except MLRA 1)</b> | <input type="checkbox"/> Very Shallow Dark Surface (TF12) |
| <input type="checkbox"/> Hydrogen Sulfide (A4)             | <input type="checkbox"/> Loamy Gleyed Matrix (F2)                        | <input type="checkbox"/> Other (Explain in Remarks)       |
| <input type="checkbox"/> Depleted Below Dark Surface (A11) | <input type="checkbox"/> Depleted Matrix (F3)                            |   |
| <input type="checkbox"/> Thick Dark Surface (A12)          | <input checked="" type="checkbox"/> Redox Dark Surface (F6)              |   |
| <input type="checkbox"/> Sandy Mucky Mineral (S1)          | <input type="checkbox"/> Depleted Dark Surface (F7)                      |   |
| <input type="checkbox"/> Sandy Gleyed Matrix (S4)          | <input type="checkbox"/> Redox Depressions (F8)                          |   |

<sup>3</sup>Indicators of hydrophytic vegetation and wetland hydrology must be present, unless disturbed or problematic.

**Restrictive Layer (if present):**

Type: \_\_\_\_\_  
Depth (inches): \_\_\_\_\_

**Hydric Soils Present?** Yes  No

Remarks:

**HYDROLOGY**

**Wetland Hydrology Indicators:**

Primary Indicators (minimum of one required; check all that apply)

Secondary Indicators (2 or more required)

- |  |   |  |
|--|---|--|
| <input type="checkbox"/> Surface Water (A1)                        | <input type="checkbox"/> Water-Stained Leaves (B9)                      | <input type="checkbox"/> Water-Stained Leaves (B9)                 |
| <input type="checkbox"/> High Water Table (A2)                     | <b>(except MLRA 1, 2, 4A, and 4B)</b>                                   | <b>(MLRA 1, 2, 4A, and 4B)</b>                                     |
| <input checked="" type="checkbox"/> Saturation (A3)                | <input type="checkbox"/> Salt Crust (B11)                               | <input type="checkbox"/> Drainage Patterns (B10)                   |
| <input type="checkbox"/> Water Marks (B1)                          | <input type="checkbox"/> Aquatic Invertebrates (B13)                    | <input type="checkbox"/> Dry-Season Water Table (C2)               |
| <input type="checkbox"/> Sediment Deposits (B2)                    | <input type="checkbox"/> Hydrogen Sulfide Odor (C1)                     | <input type="checkbox"/> Saturation Visible on Aerial Imagery (C9) |
| <input type="checkbox"/> Drift Deposits (B3)                       | <input type="checkbox"/> Oxidized Rhizospheres along Living Roots (C3)  | <input type="checkbox"/> Geomorphic Position (D2)                  |
| <input type="checkbox"/> Algal Mat or Crust (B4)                   | <input type="checkbox"/> Presence of Reduced Iron (C4)                  | <input type="checkbox"/> Shallow Aquitard (D3)                     |
| <input type="checkbox"/> Iron Deposits (B5)                        | <input type="checkbox"/> Recent Iron Reduction in Tilled Soils (C6)     | <input type="checkbox"/> FAC-Neutral Test (D5)                     |
| <input type="checkbox"/> Surface Soil Cracks (B6)                  | <input type="checkbox"/> Stunted or Stresses Plants (D1) <b>(LRR A)</b> | <input type="checkbox"/> Raised Ant Mounds (D6) <b>(LRR A)</b>     |
| <input type="checkbox"/> Inundation Visible on Aerial Imagery (B7) | <input type="checkbox"/> Other (Explain in Remarks)                     | <input type="checkbox"/> Frost-Heave Hummocks (D7)                 |
| <input type="checkbox"/> Sparsely Vegetated Concave Surface (B8)   |   |  |

**Field Observations:**

Surface Water Present? Yes  No  Depth (inches): \_\_\_\_\_  
 Water Table Present? Yes  No  Depth (inches): 13  
 Saturation Present? (includes capillary fringe) Yes  No  Depth (inches): 10

**Wetland Hydrology Present?** Yes  No

Describe Recorded Data (stream gauge, monitoring well, aerial photos, previous inspections), if available:

Remarks: Flowing water observed in adjacent ditch.

**Exhibit 16**  
**SSDP2016-00415**

Data Plot #: 22AB-SP1  
 Wetland: 22AB

## WETLAND DETERMINATION (Modified from: 1987 ACOE Wetlands Delineation Manual)

Project/Site: ELST Re-delineation Date: 4/4/2008 Revisited 09-20-13  
 Applicant/Owner: King County County: King  
 Investigator: Erik Christensen, Colin Worsley State: WA  
 1987 Method  1997 WA St. Method Community ID: PFO  
 Do Normal Circumstances exist on the site? Yes X No \_\_\_\_\_ Field Plot ID: 22AB-SP1  
 Is the site significantly disturbed (Atypical Situation)? Yes \_\_\_\_\_ No X  
 Is the area a potential Problem Area? Yes \_\_\_\_\_ No X

**Remarks** (Explain sample location, disturbances, problem areas):  
*This sample plot is located approximately 25 feet east of flag W22B-13 and the trail. The sample plot is located in the willow forested area.*

### VEGETATION (✓ Dominant species are checked)

Plant Species	% Cover	Stratum	Indicator
✓ 1. <u>Athyrium filix-femina</u>	<u>35</u>	<u>Herb</u>	<u>FAC</u>
2. <u>Cardamine oligosperma</u>	<u>5</u>	<u>Herb</u>	<u>FAC</u>
3. <u>Epilobium ciliatum</u>	<u>trace</u>	<u>Herb</u>	<u>FACW-</u>
4. <u>Geranium robertianum</u>	<u>15</u>	<u>Herb</u>	<u>NL</u>
5. <u>Lysichiton americanus</u>	<u>trace</u>	<u>Herb</u>	<u>OBL</u>
6. <u>Polystichum munitum</u>	<u>15</u>	<u>Herb</u>	<u>FACU</u>
✓ 7. <u>Cornus sericea</u>	<u>80</u>	<u>Shrub</u>	<u>FACW</u>
8. <u>Rubus armeniacus</u>	<u>5</u>	<u>Shrub</u>	<u>FACU</u>
9. <u>Alnus rubra</u>	<u>10</u>	<u>Tree</u>	<u>FAC</u>
✓ 10. <u>Salix lucida</u>	<u>30</u>	<u>Tree</u>	<u>FACW+</u>

### 09-20-13 Observations

Athyrium filix-femina 35%  
 Cardamine oligosperma 5%  
 Epilobium ciliatum trace  
 Geranium robertianum 15%  
 Lysichiton americanus trace  
 Polystichum munitum 15%  
 Cornus sericea 80%  
 Rubus armeniacus 5%  
 Alnus rubra 10%  
 Salix lucida 30%  
 Rubus parviflorus 10%

Percent of **Dominant Species** that are OBL, FACW, or FAC (except FAC-). Include species noted (\*) as showing morphological adaptations to wetlands. "T" indicates trace. 100

**Remarks** (Describe disturbances, relevant local variations, seasonal effects, etc.):  
*The percent of dominant vegetation that is hydrophytic is greater than 50%. Hydrophytic vegetation criterion is satisfied.*

### HYDROLOGY

**Recorded Data** (Describe in Remarks):  
 \_\_\_\_\_ Stream, Lake, or Tide Gage  
 \_\_\_\_\_ Aerial Photograph  
 \_\_\_\_\_ Other  
X No Recorded Data Available

**Wetland Hydrology Indicators** (Describe in Remarks):  
 Primary Indicators:  
 \_\_\_\_\_ Inundated  
X Saturated in Upper 12 inches  
 \_\_\_\_\_ Water Marks  
 \_\_\_\_\_ Drift Lines  
 \_\_\_\_\_ Sediment Deposits  
 \_\_\_\_\_ Drainage Patterns in Wetlands

#### Field Observations:

Depth of Surface Water: none (in.)  
 Depth to Free Water in Pit: 2 (in.)  
 Depth to Saturated Soil: surface (in.)

Secondary Indicators (2 or more required):  
 \_\_\_\_\_ Oxidized Rhizospheres in Upper 12 inches  
 \_\_\_\_\_ Water-Stained Leaves  
 \_\_\_\_\_ Local Soil Survey Data  
 \_\_\_\_\_ Other (Explain in Remarks)

**Remarks** (As relevant, describe recent precipitation, hydrologic modifications, local variations, etc.):  
*Soil saturation in the upper 12 inches satisfies wetland hydrology criterion.*

**09-20-13 Observations** - Soil saturated at 12 inches below the surface. Areas are saturated to the surface in vicinity.

# Parametrix

Data Plot #: 22AB-SP1  
Wetland: 22AB

Project/Site: ELST Re-delineation Date: 4/4/2008 Revisited 09-20-13

## SOIL

### Soil Survey Data:

Map Unit Name: Alderwood gravelly sandy loam, 6 to 15 % slopes Drainage Class: Moderately well drained  
Field Observations Confirm Mapped Type?

Taxonomy (Subgroup): Entic Durochrepts Yes  No  NA

### Profile Description:

Depth (Inches)	Horizon Designation	Matrix Color (Munsell Moist)	Mottle Color (Munsell Moist)	Mottle Abundance/Contrast	Texture, Concretions, Rhizospheres, etc.
0-18	A	10YR 2/1	none	none	sandy muck

**09-20-13 Observations** - Gravel present in layer.

### Hydric Soil Indicators:

- |   |   |
|---|---|
| <input type="checkbox"/> Histosol   | <input type="checkbox"/> Listed on Hydric Soils List      |
| <input type="checkbox"/> Histic Epipedon                                  | <input type="checkbox"/> Fe/Mn Concretions                |
| <input type="checkbox"/> Sulfidic Odor                                    | <input type="checkbox"/> Organic Streaking in Sandy Soils |
| <input type="checkbox"/> Aquic or Peraguc Moisture Regime                 | <input type="checkbox"/> Mottles (Redoximorphic Features) |
| <input type="checkbox"/> Reducing Conditions                              | <input type="checkbox"/> Other (Explain in Remarks)       |
| <input checked="" type="checkbox"/> Gleyed or Low-Chroma Colors           |   |
| <input checked="" type="checkbox"/> High Organic Content in Surface Layer |   |

### Remarks (Describe soil disturbances, local variations, etc.):

*Low soil chroma and high organic content in the surface layer indicate hydric soils. Hydric soil criterion is satisfied.*

## WETLAND DETERMINATION

Hydrophytic Vegetation Present?	Yes <input checked="" type="checkbox"/> No <input type="checkbox"/>	Is this Sampling Point Within a Wetland?
Hydric Soils Present?	Yes <input checked="" type="checkbox"/> No <input type="checkbox"/>	Yes <input checked="" type="checkbox"/> No <input type="checkbox"/>
Wetland Hydrology Present?	Yes <input checked="" type="checkbox"/> No <input type="checkbox"/>	

### Remarks

*Wetland vegetation, hydrology, and soil criteria are met. Therefore, the sample plot is located in a wetland.*

**Exhibit 16**  
**SSDP2016-00415**  
**000859**



Data Plot #: 22AB-SP2  
 Wetland: 22AB

## WETLAND DETERMINATION (Modified from: 1987 ACOE Wetlands Delineation Manual)

Project/Site: ELST Re-delineation Date: 4/4/2008 Revisited 09-20-13  
 Applicant/Owner: King County County: King  
 Investigator: Erik Christensen, Colin Worsley State: WA

1987 Method  1997 WA St. Method Community ID: PSS  
 Do Normal Circumstances exist on the site? Yes X No \_\_\_\_\_ Field Plot ID: 22AB-SP2  
 Is the site significantly disturbed (Atypical Situation)? Yes \_\_\_\_\_ No X  
 Is the area a potential Problem Area? Yes \_\_\_\_\_ No X

**Remarks** (Explain sample location, disturbances, problem areas):  
*This sample plot is located approximately 13.5 feet at 300 degrees northwest of flag W22B-29.*

### VEGETATION (✓ Dominant species are checked)

Plant Species	% Cover	Stratum	Indicator
✓ 1. <u>Athyrium filix-femina</u>	<u>20</u>	<u>Herb</u>	<u>FAC</u>
✓ 2. <u>Phalaris arundinacea</u>	<u>20</u>	<u>Herb</u>	<u>FACW</u>
✓ 3. <u>Scirpus microcarpus</u>	<u>30</u>	<u>Herb</u>	<u>OBL</u>
4. <u>Typha latifolia</u>	<u>15</u>	<u>Herb</u>	<u>OBL</u>
✓ 5. <u>Cornus sericea</u>	<u>40</u>	<u>Shrub</u>	<u>FACW</u>
6. <u>Physocarpus capitatus</u>	<u>5</u>	<u>Shrub</u>	<u>FACW-</u>
✓ 7. <u>Rubus armeniacus</u>	<u>30</u>	<u>Shrub</u>	<u>FACU</u>
8. <u>Rubus spectabilis</u>	<u>5</u>	<u>Shrub</u>	<u>FAC+</u>

### 09-20-13 Observations

Athyrium filix-femina 20%  
 Phalaris arundinacea 20%  
 Cornus sericea 40%  
 Rubus armeniacus 30%  
 Rubus spectabilis 5%  
 Rubus parviflorus 5%

Percent of **Dominant Species** that are OBL, FACW, or FAC (except FAC-). Include species noted (\*) as showing morphological adaptations to wetlands. "T" indicates trace. 80

**Remarks** (Describe disturbances, relevant local variations, seasonal effects, etc.):  
*More than 50% of dominant vegetation is hydrophytic. Hydrophytic vegetation criterion is satisfied.*

### HYDROLOGY

**Recorded Data** (Describe in Remarks):  
 \_\_\_\_\_ Stream, Lake, or Tide Gage  
 \_\_\_\_\_ Aerial Photograph  
 \_\_\_\_\_ Other  
X No Recorded Data Available

**Wetland Hydrology Indicators** (Describe in Remarks):

Primary Indicators:  
 \_\_\_\_\_ Inundated  
X Saturated in Upper 12 inches  
 \_\_\_\_\_ Water Marks  
 \_\_\_\_\_ Drift Lines  
 \_\_\_\_\_ Sediment Deposits  
 \_\_\_\_\_ Drainage Patterns in Wetlands

#### Field Observations:

Depth of Surface Water: none (in.)  
 Depth to Free Water in Pit: 11 (in.)  
 Depth to Saturated Soil: surface (in.)

Secondary Indicators (2 or more required):  
 \_\_\_\_\_ Oxidized Rhizospheres in Upper 12 inches  
 \_\_\_\_\_ Water-Stained Leaves  
 \_\_\_\_\_ Local Soil Survey Data  
 \_\_\_\_\_ Other (Explain in Remarks)

**Remarks** (As relevant, describe recent precipitation, hydrologic modifications, local variations, etc.):  
*Soil saturation in the upper 12 inches satisfies wetland hydrology criterion.*

# Parametrix

Data Plot #: 22AB-SP2  
Wetland: 22AB

Project/Site: ELST Re-delineation

Date: 4/4/2008

Revisited 09-20-13

## SOIL

### Soil Survey Data:

Map Unit Name: Alderwood gravelly sandy loam, 6 to 15 % slopes

Drainage Class: Moderately well drained

Field Observations Confirm Mapped Type?

Taxonomy (Subgroup): Entic Durochrepts

Yes  No  NA

### Profile Description:

Depth (Inches)	Horizon Designation	Matrix Color (Munsell Moist)	Mottle Color (Munsell Moist)	Mottle Abundance/Contrast	Texture, Concretions, Rhizospheres, etc.
0-6	A	10YR 2/1	none	none	mucky loam
6-8	A2	10YR 2/1	none	none	mucky sandy loam
8-18	A3	2.5Y 2.5/1	none	none	mucky loam

### Hydric Soil Indicators:

- |   |   |
|---|---|
| <input type="checkbox"/> Histosol   | <input type="checkbox"/> Listed on Hydric Soils List      |
| <input type="checkbox"/> Histic Epipedon                                  | <input type="checkbox"/> Fe/Mn Concretions                |
| <input type="checkbox"/> Sulfidic Odor                                    | <input type="checkbox"/> Organic Streaking in Sandy Soils |
| <input type="checkbox"/> Aquic or Peraguic Moisture Regime                | <input type="checkbox"/> Mottles (Redoximorphic Features) |
| <input type="checkbox"/> Reducing Conditions                              | <input type="checkbox"/> Other (Explain in Remarks)       |
| <input checked="" type="checkbox"/> Gleyed or Low-Chroma Colors           |   |
| <input checked="" type="checkbox"/> High Organic Content in Surface Layer |   |

### Remarks (Describe soil disturbances, local variations, etc.):

*Low soil chroma and high organic content in the surface layer indicate hydric soils. Hydric soil criterion is satisfied.*

## WETLAND DETERMINATION

Hydrophytic Vegetation Present? Yes  No

Hydric Soils Present? Yes  No

Wetland Hydrology Present? Yes  No

Is this Sampling Point Within a Wetland?

Yes  No

### Remarks

*Wetland vegetation, hydrology, and soil criteria are met. Therefore, the sample plot is located in a wetland.*

Exhibit 16  
SSDP2016-00415  
000861

# WETLAND DETERMINATION DATA FORM – Western Mountains, Valleys, and Coast Region

Project Site: ELST - South Sammamish Segment City/County: Sammamish/King Sampling Date: 10-25-13  
 Applicant/Owner: King County State: WA Sampling Point: W22CD-SP1 (rev)  
 Investigator(s): C. Worsley; M. Maynard Section, Township, Range: S06, T24N, R06E  
 Landform (hillslope, terrace, etc.): Ditch Local relief (concave, convex, none): concave Slope (%): 0  
 Subregion (LRR): A Lat: \_\_\_\_\_ Long: \_\_\_\_\_ Datum: \_\_\_\_\_  
 Soil Map Unit Name: Alderwood gravelly sandy loam, 6 to 15 % slopes NWI classification: PEM  
 Are climatic / hydrologic conditions on the site typical for this time of year? Yes  No  (If no, explain in Remarks.)  
 Are Vegetation , Soil , or Hydrology , significantly disturbed? Are "Normal Circumstances" present? Yes  No   
 Are Vegetation , Soil , or Hydrology , naturally problematic? (If needed, explain any answers in Remarks.)

### SUMMARY OF FINDINGS – Attach site map showing sampling point locations, transects, important features, etc.

Hydrophytic Vegetation Present?	Yes <input checked="" type="checkbox"/>	No <input type="checkbox"/>	<b>Is the Sampled Area within a Wetland?</b>	Yes <input checked="" type="checkbox"/>	No <input type="checkbox"/>
Hydric Soil Present?	Yes <input checked="" type="checkbox"/>	No <input type="checkbox"/>		Yes <input checked="" type="checkbox"/>	No <input type="checkbox"/>
Wetland Hydrology Present?	Yes <input checked="" type="checkbox"/>	No <input type="checkbox"/>		Yes <input checked="" type="checkbox"/>	No <input type="checkbox"/>
Remarks: Sample plot is located at south end of Wetland 22CD, approximately 5 feet east of existing trail edge, across from post with two signs ("Please Stay On Improved Surfaces" and "Leash Pets Obey Scoop Laws"). At edge of ditch bottom.					

### VEGETATION – Use scientific names of plants

Tree Stratum (Plot size: <u>NA</u> )	Absolute % Cover	Dominant Species?	Indicator Status	Dominance Test Worksheet:																
1. _____	_____	_____	_____	Number of Dominant Species That Are OBL, FACW, or FAC: <u>2</u> (A)  Total Number of Dominant Species Across All Strata: <u>3</u> (B)  Percent of Dominant Species That Are OBL, FACW, or FAC: <u>67</u> (A/B)																
2. _____	_____	_____	_____																	
3. _____	_____	_____	_____																	
4. _____	_____	_____	_____																	
50% = _____, 20% = _____	_____	= Total Cover		<b>Prevalence Index worksheet:</b>  <table style="width: 100%; border: none;"> <tr> <td style="text-align: center;">Total % Cover of:</td> <td style="text-align: center;">Multiply by:</td> </tr> <tr> <td>OBL species _____</td> <td>x1 = _____</td> </tr> <tr> <td>FACW species _____</td> <td>x2 = _____</td> </tr> <tr> <td>FAC species _____</td> <td>x3 = _____</td> </tr> <tr> <td>FACU species _____</td> <td>x4 = _____</td> </tr> <tr> <td>UPL species _____</td> <td>x5 = _____</td> </tr> <tr> <td>Column Totals: _____ (A)</td> <td>_____ (B)</td> </tr> <tr> <td colspan="2" style="text-align: center;">Prevalence Index = B/A = _____</td> </tr> </table>	Total % Cover of:	Multiply by:	OBL species _____	x1 = _____	FACW species _____	x2 = _____	FAC species _____	x3 = _____	FACU species _____	x4 = _____	UPL species _____	x5 = _____	Column Totals: _____ (A)	_____ (B)	Prevalence Index = B/A = _____	
Total % Cover of:	Multiply by:																			
OBL species _____	x1 = _____																			
FACW species _____	x2 = _____																			
FAC species _____	x3 = _____																			
FACU species _____	x4 = _____																			
UPL species _____	x5 = _____																			
Column Totals: _____ (A)	_____ (B)																			
Prevalence Index = B/A = _____																				
<b>Sapling/Shrub Stratum (Plot size: <u>NA</u>)</b>																				
1. _____	_____	_____	_____																	
2. _____	_____	_____	_____																	
3. _____	_____	_____	_____																	
4. _____	_____	_____	_____																	
5. _____	_____	_____	_____																	
50% = _____, 20% = _____	_____	= Total Cover																		
<b>Herb Stratum (Plot size: <u>3 feet</u>)</b>																				
1. <u>Scirpus microcarpus</u>	<u>40</u>	<u>yes</u>	<u>OBL</u>																	
2. <u>Holcus lanatus</u>	<u>20</u>	<u>yes</u>	<u>FAC</u>																	
3. <u>Ranunculus repens</u>	<u>10</u>	<u>no</u>	<u>FAC</u>																	
4. <u>Lotus corniculatus</u>	<u>5</u>	<u>no</u>	<u>FAC</u>																	
5. <u>Veronica americana</u>	<u>5</u>	<u>no</u>	<u>OBL</u>																	
6. <u>Glyceria elata</u>	<u>2</u>	<u>no</u>	<u>FACW</u>																	
7. <u>Convolvulus arvensis</u>	<u>2</u>	<u>no</u>	<u>NL (UPL)</u>																	
8. _____	_____	_____	_____																	
9. _____	_____	_____	_____																	
10. _____	_____	_____	_____																	
11. _____	_____	_____	_____																	
50% = <u>42</u> , 20% = <u>17</u>	<u>84</u>	= Total Cover																		
<b>Woody Vine Stratum (Plot size: <u>10 feet</u>)</b>																				
1. <u>Rubus armeniacus</u>	<u>10</u>	<u>yes</u>	<u>FACU</u>																	
2. _____	_____	_____	_____																	
50% = _____, 20% = _____	<u>10</u>	= Total Cover																		
% Bare Ground in Herb Stratum <u>5</u>																				
<b>Hydrophytic Vegetation Indicators:</b> <input type="checkbox"/> 1 – Rapid Test for Hydrophytic Vegetation <input checked="" type="checkbox"/> 2 - Dominance Test is >50% <input type="checkbox"/> 3 - Prevalence Index is ≤3.0 <sup>1</sup> <input type="checkbox"/> 4 - Morphological Adaptations <sup>1</sup> (Provide supporting data in Remarks or on a separate sheet) <input type="checkbox"/> 5 - Wetland Non-Vascular Plants <sup>1</sup> <input type="checkbox"/> Problematic Hydrophytic Vegetation <sup>1</sup> (Explain)																				
<b>Hydrophytic Vegetation Present?</b> Yes <input checked="" type="checkbox"/> No <input type="checkbox"/>																				

Remarks: Species with less than 5% cover are not considered dominant. Greater than 50% of the dominant species are hydrophytic. This satisfies the hydrophytic vegetation criterion.

**SOIL**

Profile Description: (Describe to the depth needed to document the indicator or confirm the absence of indicators.)								
Depth (inches)	Matrix		Redox Features				Texture	Remarks
	Color (moist)	%	Color (moist)	%	Type <sup>1</sup>	Loc <sup>2</sup>		
0-16	10YR 2/1	100	-	-	-	-	gr. sa. loam	
16-20	N 3/-	100	-	-	-	-	sa. loam	
_____	_____	_____	_____	_____	_____	_____	_____	_____
_____	_____	_____	_____	_____	_____	_____	_____	_____
_____	_____	_____	_____	_____	_____	_____	_____	_____
_____	_____	_____	_____	_____	_____	_____	_____	_____
_____	_____	_____	_____	_____	_____	_____	_____	_____

<sup>1</sup>Type: C= Concentration, D=Depletion, RM=Reduced Matrix, CS=Covered or Coated Sand Grains.      <sup>2</sup>Location: PL=Pore Lining, M=Matrix

<b>Hydric Soil Indicators: (Applicable to all LRRs, unless otherwise noted.)</b>			<b>Indicators for Problematic Hydric Soils<sup>3</sup>:</b>		
<input type="checkbox"/> Histosol (A1)	<input type="checkbox"/> Sandy Redox (S5)	<input type="checkbox"/> 2 cm Muck (A10)			
<input type="checkbox"/> Histic Epipedon (A2)	<input type="checkbox"/> Stripped Matrix (S6)	<input type="checkbox"/> Red Parent Material (TF2)			
<input type="checkbox"/> Black Histic (A3)	<input type="checkbox"/> Loamy Mucky Mineral (F1) <b>(except MLRA 1)</b>	<input type="checkbox"/> Very Shallow Dark Surface (TF12)			
<input type="checkbox"/> Hydrogen Sulfide (A4)	<input type="checkbox"/> Loamy Gleyed Matrix (F2)	<input checked="" type="checkbox"/> Other (Explain in Remarks)			
<input type="checkbox"/> Depleted Below Dark Surface (A11)	<input type="checkbox"/> Depleted Matrix (F3)				
<input type="checkbox"/> Thick Dark Surface (A12)	<input type="checkbox"/> Redox Dark Surface (F6)				
<input type="checkbox"/> Sandy Mucky Mineral (S1)	<input type="checkbox"/> Depleted Dark Surface (F7)				
<input type="checkbox"/> Sandy Gleyed Matrix (S4)	<input type="checkbox"/> Redox Depressions (F8)				

<sup>3</sup>Indicators of hydrophytic vegetation and wetland hydrology must be present, unless disturbed or problematic.

<b>Restrictive Layer (if present):</b>	<b>Hydric Soils Present?</b>
Type: _____	Yes <input checked="" type="checkbox"/> No <input type="checkbox"/>
Depth (inches): _____	

Remarks: The upper layer has small cobbles and organic debris in various stages of decomposition. The presence of hydrophytic vegetation and wetland hydrology, and a dark matrix with organic material, indicate the hydric soil criterion is satisfied.

**HYDROLOGY**

<b>Wetland Hydrology Indicators:</b>	
Primary Indicators (minimum of one required; check all that apply)	Secondary Indicators (2 or more required)
<input type="checkbox"/> Surface Water (A1) <input type="checkbox"/> Water-Stained Leaves (B9) <input checked="" type="checkbox"/> High Water Table (A2) <b>(except MLRA 1, 2, 4A, and 4B)</b> <input checked="" type="checkbox"/> Saturation (A3) <input type="checkbox"/> Salt Crust (B11) <input type="checkbox"/> Water Marks (B1) <input type="checkbox"/> Aquatic Invertebrates (B13) <input type="checkbox"/> Sediment Deposits (B2) <input type="checkbox"/> Hydrogen Sulfide Odor (C1) <input type="checkbox"/> Drift Deposits (B3) <input type="checkbox"/> Oxidized Rhizospheres along Living Roots (C3) <input type="checkbox"/> Algal Mat or Crust (B4) <input type="checkbox"/> Presence of Reduced Iron (C4) <input type="checkbox"/> Iron Deposits (B5) <input type="checkbox"/> Recent Iron Reduction in Tilled Soils (C6) <input type="checkbox"/> Surface Soil Cracks (B6) <input type="checkbox"/> Stunted or Stresses Plants (D1) <b>(LRR A)</b> <input type="checkbox"/> Inundation Visible on Aerial Imagery (B7) <input type="checkbox"/> Other (Explain in Remarks) <input type="checkbox"/> Sparsely Vegetated Concave Surface (B8)	<input type="checkbox"/> Water-Stained Leaves (B9) <b>(MLRA 1, 2, 4A, and 4B)</b> <input type="checkbox"/> Drainage Patterns (B10) <input type="checkbox"/> Dry-Season Water Table (C2) <input type="checkbox"/> Saturation Visible on Aerial Imagery (C9) <input type="checkbox"/> Geomorphic Position (D2) <input type="checkbox"/> Shallow Aquitard (D3) <input type="checkbox"/> FAC-Neutral Test (D5) <input type="checkbox"/> Raised Ant Mounds (D6) <b>(LRR A)</b> <input type="checkbox"/> Frost-Heave Hummocks (D7)
<b>Field Observations:</b>	<b>Wetland Hydrology Present?</b>
Surface Water Present?    Yes <input type="checkbox"/> No <input checked="" type="checkbox"/> Depth (inches): _____ Water Table Present?    Yes <input checked="" type="checkbox"/> No <input type="checkbox"/> Depth (inches): <u>  7  </u> Saturation Present?    Yes <input checked="" type="checkbox"/> No <input type="checkbox"/> Depth (inches): <u>  surface  </u>	Yes <input checked="" type="checkbox"/> No <input type="checkbox"/>
Describe Recorded Data (stream gauge, monitoring well, aerial photos, previous inspections), if available:	
Remarks: 3 inches inundation in bottom of ditch present immediately adjacent to soil pit. Soil saturation to the surface satisfies the wetland hydrology criterion.	

**Exhibit 16**  
**SSDP2016-00415**

# WETLAND DETERMINATION DATA FORM – Western Mountains, Valleys, and Coast Region

Project Site: ELST - South Sammamish Segment City/County: Sammamish/King Sampling Date: 10-25-13  
 Applicant/Owner: King County State: WA Sampling Point: W22CD-SP2 (rev)  
 Investigator(s): C. Worsley; M. Maynard Section, Township, Range: S06, T24N, R06E  
 Landform (hillslope, terrace, etc.): hillslope Local relief (concave, convex, none): convex Slope (%): 2  
 Subregion (LRR): A Lat: \_\_\_\_\_ Long: \_\_\_\_\_ Datum: \_\_\_\_\_  
 Soil Map Unit Name: Alderwood gravelly sandy loam, 6 to 15 % slopes NWI classification: NA  
 Are climatic / hydrologic conditions on the site typical for this time of year? Yes  No  (If no, explain in Remarks.)  
 Are Vegetation , Soil , or Hydrology , significantly disturbed? Are "Normal Circumstances" present? Yes  No   
 Are Vegetation , Soil , or Hydrology , naturally problematic? (If needed, explain any answers in Remarks.)

### SUMMARY OF FINDINGS – Attach site map showing sampling point locations, transects, important features, etc.

Hydrophytic Vegetation Present?	Yes <input checked="" type="checkbox"/>	No <input type="checkbox"/>	<b>Is the Sampled Area within a Wetland?</b>	Yes <input type="checkbox"/>	No <input checked="" type="checkbox"/>
Hydric Soil Present?	Yes <input type="checkbox"/>	No <input checked="" type="checkbox"/>		Yes <input type="checkbox"/>	No <input checked="" type="checkbox"/>
Wetland Hydrology Present?	Yes <input type="checkbox"/>	No <input checked="" type="checkbox"/>		Yes <input type="checkbox"/>	No <input checked="" type="checkbox"/>
Remarks: Sample plot is located approximately 15 feet east of wetland boundary flag W22CD-4, in <i>Rubus armeniacus</i> , just west of <i>Thuja plicata</i> . Near south end of W22CD.					

### VEGETATION – Use scientific names of plants

Tree Stratum (Plot size: 30 feet)	Absolute % Cover	Dominant Species?	Indicator Status	Dominance Test Worksheet:
1. <u><i>Thuja plicata</i></u>	<u>15</u>	<u>yes</u>	<u>FAC</u>	Number of Dominant Species That Are OBL, FACW, or FAC: <u>4</u> (A) Total Number of Dominant Species Across All Strata: <u>5</u> (B) Percent of Dominant Species That Are OBL, FACW, or FAC: <u>80</u> (A/B)
2. _____	_____	_____	_____	
3. _____	_____	_____	_____	
4. _____	_____	_____	_____	
50% = _____, 20% = _____	<u>15</u>	= Total Cover		
<u>Sapling/Shrub Stratum (Plot size: 10 feet)</u>				<b>Prevalence Index worksheet:</b> Total % Cover of: _____ Multiply by: OBL species _____ x1 = _____ FACW species _____ x2 = _____ FAC species _____ x3 = _____ FACU species _____ x4 = _____ UPL species _____ x5 = _____ Column Totals: _____ (A) _____ (B) Prevalence Index = B/A = _____
1. <u><i>Cornus alba (Cornus sericea)</i></u>	<u>10</u>	<u>yes</u>	<u>FACW</u>	
2. _____	_____	_____	_____	
3. _____	_____	_____	_____	
4. _____	_____	_____	_____	
5. _____	_____	_____	_____	
50% = _____, 20% = _____	<u>10</u>	= Total Cover		
<u>Herb Stratum (Plot size: 3 feet)</u>				<b>Hydrophytic Vegetation Indicators:</b> <input type="checkbox"/> 1 – Rapid Test for Hydrophytic Vegetation <input checked="" type="checkbox"/> 2 - Dominance Test is >50% <input type="checkbox"/> 3 - Prevalence Index is ≤3.0 <sup>1</sup> <input type="checkbox"/> 4 - Morphological Adaptations <sup>1</sup> (Provide supporting data in Remarks or on a separate sheet) <input type="checkbox"/> 5 - Wetland Non-Vascular Plants <sup>1</sup> <input type="checkbox"/> Problematic Hydrophytic Vegetation <sup>1</sup> (Explain)  <sup>1</sup> Indicators of hydric soil and wetland hydrology must be present, unless disturbed or problematic.
1. <u><i>Scirpus microcarpus</i></u>	<u>2</u>	<u>no</u>	<u>OBL</u>	
2. <u><i>Equisetum telmateia</i></u>	<u>15</u>	<u>yes</u>	<u>FACW</u>	
3. <u><i>Ranunculus repens</i></u>	<u>2</u>	<u>no</u>	<u>FAC</u>	
4. <u><i>Phalaris arundinacea</i></u>	<u>10</u>	<u>yes</u>	<u>FACW</u>	
5. _____	_____	_____	_____	
6. _____	_____	_____	_____	
7. _____	_____	_____	_____	
8. _____	_____	_____	_____	
9. _____	_____	_____	_____	
10. _____	_____	_____	_____	
11. _____	_____	_____	_____	
50% = <u>15</u> , 20% = <u>6</u>	<u>29</u>	= Total Cover		
<u>Woody Vine Stratum (Plot size: 10 feet)</u>				<b>Hydrophytic Vegetation Present?</b> Yes <input checked="" type="checkbox"/> No <input type="checkbox"/>
1. <u><i>Rubus armeniacus</i></u>	<u>60</u>	<u>yes</u>	<u>FACU</u>	
2. _____	_____	_____	_____	
50% = _____, 20% = _____	<u>60</u>	= Total Cover		
% Bare Ground in Herb Stratum <u>5</u>				

Remarks: Species with less than 5% cover are not considered dominant. Greater than 50% of the dominant species are hydrophytic. This satisfies the hydrophytic vegetation criterion.

**SOIL**

**Profile Description: (Describe to the depth needed to document the indicator or confirm the absence of indicators.)**

Depth (inches)	Matrix		Redox Features				Texture	Remarks
	Color (moist)	%	Color (moist)	%	Type <sup>1</sup>	Loc <sup>2</sup>		
0-20	10YR 2/1	100	-	-	-	-	gr. sa. loam	
_____	_____	_____	_____	_____	_____	_____	_____	_____
_____	_____	_____	_____	_____	_____	_____	_____	_____
_____	_____	_____	_____	_____	_____	_____	_____	_____
_____	_____	_____	_____	_____	_____	_____	_____	_____
_____	_____	_____	_____	_____	_____	_____	_____	_____

<sup>1</sup>Type: C= Concentration, D=Depletion, RM=Reduced Matrix, CS=Covered or Coated Sand Grains. <sup>2</sup>Location: PL=Pore Lining, M=Matrix

**Hydric Soil Indicators: (Applicable to all LRRs, unless otherwise noted.)**

- Histic Epipedon (A2)
- Black Histic (A3)
- Hydrogen Sulfide (A4)
- Depleted Below Dark Surface (A11)
- Thick Dark Surface (A12)
- Sandy Mucky Mineral (S1)
- Sandy Gleyed Matrix (S4)
- Sandy Redox (S5)
- Stripped Matrix (S6)
- Loamy Mucky Mineral (F1) **(except MLRA 1)**
- Loamy Gleyed Matrix (F2)
- Depleted Matrix (F3)
- Redox Dark Surface (F6)
- Depleted Dark Surface (F7)
- Redox Depressions (F8)

**Indicators for Problematic Hydric Soils<sup>3</sup>:**

- 2 cm Muck (A10)
- Red Parent Material (TF2)
- Very Shallow Dark Surface (TF12)
- Other (Explain in Remarks)

<sup>3</sup>Indicators of hydrophytic vegetation and wetland hydrology must be present, unless disturbed or problematic.

**Restrictive Layer (if present):**

Type: \_\_\_\_\_  
 Depth (inches): \_\_\_\_\_

**Hydric Soils Present?** Yes  No

Remarks: \_\_\_\_\_

**HYDROLOGY**

**Wetland Hydrology Indicators:**

Primary Indicators (minimum of one required; check all that apply)

- Surface Water (A1)
- High Water Table (A2)
- Saturation (A3)
- Water Marks (B1)
- Sediment Deposits (B2)
- Drift Deposits (B3)
- Algal Mat or Crust (B4)
- Iron Deposits (B5)
- Surface Soil Cracks (B6)
- Inundation Visible on Aerial Imagery (B7)
- Sparsely Vegetated Concave Surface (B8)
- Water-Stained Leaves (B9) **(except MLRA 1, 2, 4A, and 4B)**
- Salt Crust (B11)
- Aquatic Invertebrates (B13)
- Hydrogen Sulfide Odor (C1)
- Oxidized Rhizospheres along Living Roots (C3)
- Presence of Reduced Iron (C4)
- Recent Iron Reduction in Tilled Soils (C6)
- Stunted or Stresses Plants (D1) **(LRR A)**
- Other (Explain in Remarks)

Secondary Indicators (2 or more required)

- Water-Stained Leaves (B9) **(MLRA 1, 2, 4A, and 4B)**
- Drainage Patterns (B10)
- Dry-Season Water Table (C2)
- Saturation Visible on Aerial Imagery (C9)
- Geomorphic Position (D2)
- Shallow Aquitard (D3)
- FAC-Neutral Test (D5)
- Raised Ant Mounds (D6) **(LRR A)**
- Frost-Heave Hummocks (D7)

**Field Observations:**

Surface Water Present? Yes  No  Depth (inches): \_\_\_\_\_  
 Water Table Present? Yes  No  Depth (inches): \_\_\_\_\_  
 Saturation Present? (includes capillary fringe) Yes  No  Depth (inches): \_\_\_\_\_

**Wetland Hydrology Present?** Yes  No

Describe Recorded Data (stream gauge, monitoring well, aerial photos, previous inspections), if available:

Remarks: \_\_\_\_\_

**Exhibit 16**  
**SSDP2016-00415**

# WETLAND DETERMINATION DATA FORM – Western Mountains, Valleys, and Coast Region

Project Site: ELST - South Sammamish Segment City/County: Sammamish/King Sampling Date: 10-25-13  
 Applicant/Owner: King County State: WA Sampling Point: W22E-SP1  
 Investigator(s): C. Worsley, M. Maynard Section, Township, Range: S06, T24N, R06E  
 Landform (hillslope, terrace, etc.): Ditch/Swale Local relief (concave, convex, none): concave Slope (%): 0  
 Subregion (LRR): A Lat: \_\_\_\_\_ Long: \_\_\_\_\_ Datum: \_\_\_\_\_  
 Soil Map Unit Name: Alderwood gravelly sandy loam, 6 to 15 % slopes NWI classification: PEM  
 Are climatic / hydrologic conditions on the site typical for this time of year? Yes  No  (If no, explain in Remarks.)  
 Are Vegetation , Soil , or Hydrology , significantly disturbed? Are "Normal Circumstances" present? Yes  No   
 Are Vegetation , Soil , or Hydrology , naturally problematic? (If needed, explain any answers in Remarks.)

### SUMMARY OF FINDINGS – Attach site map showing sampling point locations, transects, important features, etc.

Hydrophytic Vegetation Present?	Yes <input checked="" type="checkbox"/>	No <input type="checkbox"/>	<b>Is the Sampled Area within a Wetland?</b>	Yes <input checked="" type="checkbox"/>	No <input type="checkbox"/>
Hydric Soil Present?	Yes <input checked="" type="checkbox"/>	No <input type="checkbox"/>		Yes <input checked="" type="checkbox"/>	No <input type="checkbox"/>
Wetland Hydrology Present?	Yes <input checked="" type="checkbox"/>	No <input type="checkbox"/>		Yes <input checked="" type="checkbox"/>	No <input type="checkbox"/>
Remarks: Sample plot is located approximately 3 feet west of trail in ditch/swale. Toward south end of Wetland 22E.					

### VEGETATION – Use scientific names of plants

Tree Stratum (Plot size: <u>NA</u> )	Absolute % Cover	Dominant Species?	Indicator Status	Dominance Test Worksheet:																
1. _____	_____	_____	_____	Number of Dominant Species That Are OBL, FACW, or FAC: <u>3</u> (A) Total Number of Dominant Species Across All Strata: <u>3</u> (B) Percent of Dominant Species That Are OBL, FACW, or FAC: <u>100</u> (A/B)																
2. _____	_____	_____	_____																	
3. _____	_____	_____	_____																	
4. _____	_____	_____	_____																	
50% = _____, 20% = _____	_____	= Total Cover		<b>Prevalence Index worksheet:</b> <table style="width: 100%; border: none;"> <tr> <td style="text-align: center;"><u>Total % Cover of:</u></td> <td style="text-align: center;"><u>Multiply by:</u></td> </tr> <tr> <td>OBL species _____</td> <td>x1 = _____</td> </tr> <tr> <td>FACW species _____</td> <td>x2 = _____</td> </tr> <tr> <td>FAC species _____</td> <td>x3 = _____</td> </tr> <tr> <td>FACU species _____</td> <td>x4 = _____</td> </tr> <tr> <td>UPL species _____</td> <td>x5 = _____</td> </tr> <tr> <td>Column Totals: _____ (A)</td> <td>_____ (B)</td> </tr> <tr> <td colspan="2" style="text-align: center;">Prevalence Index = B/A = _____</td> </tr> </table>	<u>Total % Cover of:</u>	<u>Multiply by:</u>	OBL species _____	x1 = _____	FACW species _____	x2 = _____	FAC species _____	x3 = _____	FACU species _____	x4 = _____	UPL species _____	x5 = _____	Column Totals: _____ (A)	_____ (B)	Prevalence Index = B/A = _____	
<u>Total % Cover of:</u>	<u>Multiply by:</u>																			
OBL species _____	x1 = _____																			
FACW species _____	x2 = _____																			
FAC species _____	x3 = _____																			
FACU species _____	x4 = _____																			
UPL species _____	x5 = _____																			
Column Totals: _____ (A)	_____ (B)																			
Prevalence Index = B/A = _____																				
<u>Sapling/Shrub Stratum (Plot size: NA)</u>																				
1. _____	_____	_____	_____																	
2. _____	_____	_____	_____																	
3. _____	_____	_____	_____																	
4. _____	_____	_____	_____																	
5. _____	_____	_____	_____																	
50% = _____, 20% = _____	_____	= Total Cover																		
<u>Herb Stratum (Plot size: 3 feet, confined to wetland boundary)</u>																				
1. <u><i>Equisetum telmateia</i></u>	<u>80</u>	<u>yes</u>	<u>FACW</u>																	
2. <u><i>Scirpus microcarpus</i></u>	<u>30</u>	<u>yes</u>	<u>OBL</u>																	
3. <u><i>Phalaris arundinacea</i></u>	<u>30</u>	<u>yes</u>	<u>FACW</u>																	
4. <u><i>Holcus lanatus</i></u>	<u>10</u>	<u>no</u>	<u>FAC</u>																	
5. <u><i>Ranunculus repens</i></u>	<u>5</u>	<u>no</u>	<u>FAC</u>																	
6. <u><i>Lysichiton americanus</i></u>	<u>5</u>	<u>no</u>	<u>OBL</u>																	
7. <u><i>Stachys chamissonis</i></u>	<u>2</u>	<u>no</u>	<u>FACW</u>																	
8. _____	_____	_____	_____																	
9. _____	_____	_____	_____																	
10. _____	_____	_____	_____																	
11. _____	_____	_____	_____																	
50% = <u>66</u> , 20% = <u>26</u>	<u>132</u>	= Total Cover																		
<u>Woody Vine Stratum (Plot size: 10 feet)</u>																				
1. <u><i>Rubus armeniacus</i></u>	<u>5</u>	<u>n/a*</u>	<u>FACU</u>																	
2. <u><i>Solanum dulcamara</i></u>	<u>2</u>	<u>no</u>	<u>FAC</u>																	
50% = <u>4</u> , 20% = <u>1</u>	<u>7</u>	= Total Cover																		
% Bare Ground in Herb Stratum <u>0</u>																				
<table style="width: 100%; border: none;"> <tr> <td style="width: 30%;"><b>Hydrophytic Vegetation Present?</b></td> <td style="width: 10%;">Yes</td> <td style="width: 10%;">No</td> <td style="width: 10%;"><input checked="" type="checkbox"/></td> <td style="width: 10%;"><input type="checkbox"/></td> </tr> </table>				<b>Hydrophytic Vegetation Present?</b>	Yes	No	<input checked="" type="checkbox"/>	<input type="checkbox"/>												
<b>Hydrophytic Vegetation Present?</b>	Yes	No	<input checked="" type="checkbox"/>	<input type="checkbox"/>																

Remarks: \*excluded from calculations per chapter 2 guidance Species with less than 5% cover are not considered dominant. 100% of the dominant species are hydrophytic. This satisfies the hydrophytic vegetation criterion.

**Exhibit 16**

**SSDP2016-00415**

**000866**

**SOIL**

**Profile Description: (Describe to the depth needed to document the indicator or confirm the absence of indicators.)**

Depth (inches)	Matrix		Redox Features				Texture	Remarks
	Color (moist)	%	Color (moist)	%	Type <sup>1</sup>	Loc <sup>2</sup>		
0-13	<u>10YR 2/2</u>	<u>100</u>	-	-	-	-	<u>silt loam</u>	<u>with some organics</u>
13-20	<u>10Y 4/1</u>	<u>90</u>	<u>10YR 4/6</u>	<u>10</u>	<u>C</u>	<u>M</u>	<u>gr. sa. loam</u>	<u>with small cobbles</u>
_____	_____	_____	_____	_____	_____	_____	_____	_____
_____	_____	_____	_____	_____	_____	_____	_____	_____
_____	_____	_____	_____	_____	_____	_____	_____	_____
_____	_____	_____	_____	_____	_____	_____	_____	_____
_____	_____	_____	_____	_____	_____	_____	_____	_____

<sup>1</sup>Type: C= Concentration, D=Depletion, RM=Reduced Matrix, CS=Covered or Coated Sand Grains. <sup>2</sup>Location: PL=Pore Lining, M=Matrix

**Hydric Soil Indicators: (Applicable to all LRRs, unless otherwise noted.)**

- Histosol (A1)
- Histic Epipedon (A2)
- Black Histic (A3)
- Hydrogen Sulfide (A4)
- Depleted Below Dark Surface (A11)
- Thick Dark Surface (A12)
- Sandy Mucky Mineral (S1)
- Sandy Gleyed Matrix (S4)
- Sandy Redox (S5)
- Stripped Matrix (S6)
- Loamy Mucky Mineral (F1) **(except MLRA 1)**
- Loamy Gleyed Matrix (F2)
- Depleted Matrix (F3)
- Redox Dark Surface (F6)
- Depleted Dark Surface (F7)
- Redox Depressions (F8)

**Indicators for Problematic Hydric Soils<sup>3</sup>:**

- 2 cm Muck (A10)
- Red Parent Material (TF2)
- Very Shallow Dark Surface (TF12)
- Other (Explain in Remarks)

<sup>3</sup>Indicators of hydrophytic vegetation and wetland hydrology must be present, unless disturbed or problematic.

**Restrictive Layer (if present):**

Type: \_\_\_\_\_  
 Depth (inches): \_\_\_\_\_

**Hydric Soils Present?** Yes  No

Remarks: Organics in upper layer are likely from mowed vegetation and arbor vitae detritus. Soils are commonly disturbed along trail corridor. The presence of hydrophytic vegetation and wetland hydrology, and a gleyed matrix just below 12 inches in an area prone to disturbance, indicate the hydric soil criterion is satisfied.

**HYDROLOGY**

**Wetland Hydrology Indicators:**

Primary Indicators (minimum of one required; check all that apply)

- Surface Water (A1)
- High Water Table (A2)
- Saturation (A3)
- Water Marks (B1)
- Sediment Deposits (B2)
- Drift Deposits (B3)
- Algal Mat or Crust (B4)
- Iron Deposits (B5)
- Surface Soil Cracks (B6)
- Inundation Visible on Aerial Imagery (B7)
- Sparsely Vegetated Concave Surface (B8)
- Water-Stained Leaves (B9) **(except MLRA 1, 2, 4A, and 4B)**
- Salt Crust (B11)
- Aquatic Invertebrates (B13)
- Hydrogen Sulfide Odor (C1)
- Oxidized Rhizospheres along Living Roots (C3)
- Presence of Reduced Iron (C4)
- Recent Iron Reduction in Tilled Soils (C6)
- Stunted or Stresses Plants (D1) **(LRR A)**
- Other (Explain in Remarks)

Secondary Indicators (2 or more required)

- Water-Stained Leaves (B9) **(MLRA 1, 2, 4A, and 4B)**
- Drainage Patterns (B10)
- Dry-Season Water Table (C2)
- Saturation Visible on Aerial Imagery (C9)
- Geomorphic Position (D2)
- Shallow Aquitard (D3)
- FAC-Neutral Test (D5)
- Raised Ant Mounds (D6) **(LRR A)**
- Frost-Heave Hummocks (D7)

**Field Observations:**

Surface Water Present? Yes  No  Depth (inches): \_\_\_\_\_  
 Water Table Present? Yes  No  Depth (inches): 11  
 Saturation Present? (includes capillary fringe) Yes  No  Depth (inches): surface

**Wetland Hydrology Present?** Yes  No

Describe Recorded Data (stream gauge, monitoring well, aerial photos, previous inspections), if available:

Remarks: Soil saturation to the surface satisfies the wetland hydrology criterion.

**Exhibit 16**  
**SSDP2016-00415**



# WETLAND DETERMINATION DATA FORM – Western Mountains, Valleys, and Coast Region

Project Site: ELST - South Sammamish Segment City/County: Sammamish/King Sampling Date: 10-25-13  
 Applicant/Owner: King County State: WA Sampling Point: W23A-SP1 (rev)  
 Investigator(s): C. Worsley; M. Maynard Section, Township, Range: S06, T24N, R06E  
 Landform (hillslope, terrace, etc.): slope Local relief (concave, convex, none): convex Slope (%): 2  
 Subregion (LRR): A Lat: \_\_\_\_\_ Long: \_\_\_\_\_ Datum: \_\_\_\_\_  
 Soil Map Unit Name: Alderwood gravelly sandy loam, 15 to 30% slopes NWI classification: PEM  
 Are climatic / hydrologic conditions on the site typical for this time of year? Yes  No  (If no, explain in Remarks.)  
 Are Vegetation , Soil , or Hydrology , significantly disturbed? Are "Normal Circumstances" present? Yes  No   
 Are Vegetation , Soil , or Hydrology , naturally problematic? (If needed, explain any answers in Remarks.)

### SUMMARY OF FINDINGS – Attach site map showing sampling point locations, transects, important features, etc.

Hydrophytic Vegetation Present?	Yes <input checked="" type="checkbox"/>	No <input type="checkbox"/>	<b>Is the Sampled Area within a Wetland?</b>	Yes <input checked="" type="checkbox"/>	No <input type="checkbox"/>
Hydric Soil Present?	Yes <input checked="" type="checkbox"/>	No <input type="checkbox"/>		Yes <input checked="" type="checkbox"/>	No <input type="checkbox"/>
Wetland Hydrology Present?	Yes <input checked="" type="checkbox"/>	No <input type="checkbox"/>		Yes <input checked="" type="checkbox"/>	No <input type="checkbox"/>
Remarks: Sample plot is located at northern end of wetland, approximately 8 feet east of trail, 3 feet east of ditch, and 20 feet south of wood stairs.					

### VEGETATION – Use scientific names of plants

Tree Stratum (Plot size: <u>NA</u> )	Absolute % Cover	Dominant Species?	Indicator Status	Dominance Test Worksheet:
1. _____	_____	_____	_____	Number of Dominant Species That Are OBL, FACW, or FAC: <u>3</u> (A)  Total Number of Dominant Species Across All Strata: <u>5</u> (B)  Percent of Dominant Species That Are OBL, FACW, or FAC: <u>60</u> (A/B)
2. _____	_____	_____	_____	
3. _____	_____	_____	_____	
4. _____	_____	_____	_____	
50% = _____, 20% = _____	_____	= Total Cover	_____	
<u>Sapling/Shrub Stratum (Plot size: 10 feet)</u>				<b>Prevalence Index worksheet:</b>  Total % Cover of: _____ Multiply by: OBL species _____ x1 = _____ FACW species _____ x2 = _____ FAC species _____ x3 = _____ FACU species _____ x4 = _____ UPL species _____ x5 = _____ Column Totals: _____ (A) _____ (B) Prevalence Index = B/A = _____
1. <u>Rosa pisocarpa</u>	<u>35</u>	<u>yes</u>	<u>FAC</u>	
2. _____	_____	_____	_____	
3. _____	_____	_____	_____	
4. _____	_____	_____	_____	
5. _____	_____	_____	_____	
50% = _____, 20% = _____	<u>35</u>	= Total Cover	_____	
<u>Herb Stratum (Plot size: 3 feet)</u>				<b>Hydrophytic Vegetation Indicators:</b> <input type="checkbox"/> 1 – Rapid Test for Hydrophytic Vegetation <input checked="" type="checkbox"/> 2 - Dominance Test is >50% <input type="checkbox"/> 3 - Prevalence Index is ≤3.0' <input type="checkbox"/> 4 - Morphological Adaptations <sup>1</sup> (Provide supporting data in Remarks or on a separate sheet) <input type="checkbox"/> 5 - Wetland Non-Vascular Plants <sup>1</sup> <input type="checkbox"/> Problematic Hydrophytic Vegetation <sup>1</sup> (Explain)  <sup>1</sup> Indicators of hydric soil and wetland hydrology must be present, unless disturbed or problematic.
1. <u>Scirpus microcarpus</u>	<u>20</u>	<u>yes</u>	<u>OBL</u>	
2. <u>Athyrium cyclosorum (Athyrium filix-femina)</u>	<u>25</u>	<u>yes</u>	<u>FAC</u>	
3. <u>Chamaenerion angustifolium (Epilobium a.)</u>	<u>30</u>	<u>yes</u>	<u>FACU</u>	
4. <u>Lotus corniculatus</u>	<u>10</u>	<u>no</u>	<u>FAC</u>	
5. <u>Phalaris arundinacea</u>	<u>10</u>	<u>no</u>	<u>FACW</u>	
6. <u>Juncus effusus</u>	<u>10</u>	<u>no</u>	<u>FACW</u>	
7. <u>Polystichum munitum</u>	<u>10</u>	<u>no</u>	<u>FACU</u>	
8. <u>Festuca rubra</u>	<u>10</u>	<u>no</u>	<u>FAC</u>	
9. <u>Veronica americana</u>	<u>8</u>	<u>no</u>	<u>OBL</u>	
10. <u>Equisetum telmateia</u>	<u>5</u>	<u>no</u>	<u>FACW</u>	
11. <u>Equisetum hyemale</u>	<u>2</u>	<u>no</u>	<u>FACW</u>	
50% = <u>70</u> , 20% = <u>28</u>	<u>140</u>	= Total Cover	_____	
<u>Woody Vine Stratum (Plot size: 10 feet)</u>				<b>Hydrophytic Vegetation Present?</b> Yes <input checked="" type="checkbox"/> No <input type="checkbox"/>
1. <u>Rubus armeniacus</u>	<u>15</u>	<u>yes</u>	<u>FACU</u>	
2. <u>Rubus ursinus</u>	<u>2</u>	<u>no</u>	<u>FACU</u>	
50% = <u>8</u> , 20% = <u>3</u>	<u>15</u>	= Total Cover	_____	
% Bare Ground in Herb Stratum <u>0</u>				

Remarks: Species with less than 5% cover are not considered dominant. Greater than 50% of the dominant species are hydrophytic. This satisfies the hydrophytic vegetation criterion.

**SOIL**

**Profile Description: (Describe to the depth needed to document the indicator or confirm the absence of indicators.)**

Depth (inches)	Matrix		Redox Features				Texture	Remarks
	Color (moist)	%	Color (moist)	%	Type <sup>1</sup>	Loc <sup>2</sup>		
0-10	10YR 2/1	100	-	-	-	-	gr. sa. loam	
10-18	2.5Y 3/1	98	10YR 4/6	2	C	M	gr. sa. loam	
_____	_____	_____	_____	_____	_____	_____	_____	_____
_____	_____	_____	_____	_____	_____	_____	_____	_____
_____	_____	_____	_____	_____	_____	_____	_____	_____
_____	_____	_____	_____	_____	_____	_____	_____	_____
_____	_____	_____	_____	_____	_____	_____	_____	_____

<sup>1</sup>Type: C= Concentration, D=Depletion, RM=Reduced Matrix, CS=Covered or Coated Sand Grains. <sup>2</sup>Location: PL=Pore Lining, M=Matrix

**Hydric Soil Indicators: (Applicable to all LRRs, unless otherwise noted.)**

- Histosol (A1)
- Histic Epipedon (A2)
- Black Histic (A3)
- Hydrogen Sulfide (A4)
- Depleted Below Dark Surface (A11)
- Thick Dark Surface (A12)
- Sandy Mucky Mineral (S1)
- Sandy Gleyed Matrix (S4)
- Sandy Redox (S5)
- Stripped Matrix (S6)
- Loamy Mucky Mineral (F1) **(except MLRA 1)**
- Loamy Gleyed Matrix (F2)
- Depleted Matrix (F3)
- Redox Dark Surface (F6)
- Depleted Dark Surface (F7)
- Redox Depressions (F8)

**Indicators for Problematic Hydric Soils<sup>3</sup>:**

- 2 cm Muck (A10)
- Red Parent Material (TF2)
- Very Shallow Dark Surface (TF12)
- Other (Explain in Remarks)

<sup>3</sup>Indicators of hydrophytic vegetation and wetland hydrology must be present, unless disturbed or problematic.

**Restrictive Layer (if present):**

Type: \_\_\_\_\_  
 Depth (inches): \_\_\_\_\_

**Hydric Soils Present?** Yes  No

Remarks: The presence of hydrophytic vegetation and wetland hydrology, and a dark matrix with redox concentrations, indicate the hydric soil criterion is satisfied.

**HYDROLOGY**

**Wetland Hydrology Indicators:**

Primary Indicators (minimum of one required; check all that apply)

- Surface Water (A1)
- High Water Table (A2)
- Saturation (A3)
- Water Marks (B1)
- Sediment Deposits (B2)
- Drift Deposits (B3)
- Algal Mat or Crust (B4)
- Iron Deposits (B5)
- Surface Soil Cracks (B6)
- Inundation Visible on Aerial Imagery (B7)
- Sparsely Vegetated Concave Surface (B8)
- Water-Stained Leaves (B9) **(except MLRA 1, 2, 4A, and 4B)**
- Salt Crust (B11)
- Aquatic Invertebrates (B13)
- Hydrogen Sulfide Odor (C1)
- Oxidized Rhizospheres along Living Roots (C3)
- Presence of Reduced Iron (C4)
- Recent Iron Reduction in Tilled Soils (C6)
- Stunted or Stresses Plants (D1) **(LRR A)**
- Other (Explain in Remarks)

Secondary Indicators (2 or more required)

- Water-Stained Leaves (B9) **(MLRA 1, 2, 4A, and 4B)**
- Drainage Patterns (B10)
- Dry-Season Water Table (C2)
- Saturation Visible on Aerial Imagery (C9)
- Geomorphic Position (D2)
- Shallow Aquitard (D3)
- FAC-Neutral Test (D5)
- Raised Ant Mounds (D6) **(LRR A)**
- Frost-Heave Hummocks (D7)

**Field Observations:**

Surface Water Present? Yes  No  Depth (inches): \_\_\_\_\_  
 Water Table Present? Yes  No  Depth (inches): \_\_\_\_\_  
 Saturation Present? (includes capillary fringe) Yes  No  Depth (inches): 9

**Wetland Hydrology Present?** Yes  No

Describe Recorded Data (stream gauge, monitoring well, aerial photos, previous inspections), if available:

Remarks: Soil saturation in the upper 12 inches satisfies the wetland hydrology criterion.

**Exhibit 16**  
**SSDP2016-00415**

Data Plot #: 23A-SP2  
 Wetland: Upland near 23A

## WETLAND DETERMINATION (Modified from: 1987 ACOE Wetlands Delineation Manual)

Project/Site: ELST Re-delineation Date: 11/7/2007 Revised 10-25-13  
 Applicant/Owner: King County County: King  
 Investigator: Erik Christensen, Chip Maney State: WA  
 1987 Method  1997 WA St. Method Community ID: Upland Herb  
 Do Normal Circumstances exist on the site? Yes X No \_\_\_\_\_ Field Plot ID: 23A-SP2  
 Is the site significantly disturbed (Atypical Situation)? Yes \_\_\_\_\_ No X  
 Is the area a potential Problem Area? Yes \_\_\_\_\_ No X

**Remarks** (Explain sample location, disturbances, problem areas):  
*This sample plot is located approximately 10 feet northeast of flag W23A-5.*

### VEGETATION (✓ Dominant species are checked)

Plant Species	% Cover	Stratum	Indicator
✓ 1. <u>Equisetum arvense</u>	<u>50</u>	<u>H</u>	<u>FAC</u>
2. <u>Polystichum munitum</u>	<u>trace</u>	<u>H</u>	<u>FACU</u>
✓ 3. <u>Pteridium aquilinum</u>	<u>90</u>	<u>H</u>	<u>FACU</u>
4. <u>Gaultheria shallon</u>	<u>trace</u>	<u>S</u>	<u>FACU</u>
5. <u>Rosa pisocarpa</u>	<u>5</u>	<u>S</u>	<u>FAC</u>
6. <u>Rubus armeniacus</u>	<u>5</u>	<u>S</u>	<u>FACU</u>
✓ 7. <u>Acer macrophyllum</u>	<u>20</u>	<u>T</u>	<u>FACU</u>

Percent of **Dominant Species** that are OBL, FACW, or FAC (except FAC-). Include species noted (\*) as showing morphological adaptations to wetlands. "T" indicates trace. 33

**Remarks** (Describe disturbances, relevant local variations, seasonal effects, etc.):  
*The percent of dominant species that are hydrophytic is not greater than 50 percent. Hydrophytic vegetation criterion is not satisfied.*

### HYDROLOGY

**Recorded Data** (Describe in Remarks):  
 \_\_\_\_\_ Stream, Lake, or Tide Gage  
 \_\_\_\_\_ Aerial Photograph  
 \_\_\_\_\_ Other  
X No Recorded Data Available

**Wetland Hydrology Indicators** (Describe in Remarks):

Primary Indicators:  
 \_\_\_\_\_ Inundated  
 \_\_\_\_\_ Saturated in Upper 12 inches  
 \_\_\_\_\_ Water Marks  
 \_\_\_\_\_ Drift Lines  
 \_\_\_\_\_ Sediment Deposits  
 \_\_\_\_\_ Drainage Patterns in Wetlands

**Field Observations:**

Depth of Surface Water: none (in.)  
 Depth to Free Water in Pit: none (in.)  
 Depth to Saturated Soil: 13 (in.)

Secondary Indicators (2 or more required):  
 \_\_\_\_\_ Oxidized Rhizospheres in Upper 12 inches  
 \_\_\_\_\_ Water-Stained Leaves  
 \_\_\_\_\_ Local Soil Survey Data  
 \_\_\_\_\_ Other (Explain in Remarks)

**Remarks** (As relevant, describe recent precipitation, hydrologic modifications, local variations, etc.):  
*Saturation in the upper 12 inches satisfies wetland hydrology criterion.*

# Parametrix

Data Plot #: 23A-SP2  
Wetland: Upland near 23A

Project/Site: ELST Re-delineation Date: 11/7/2007 Revisited 10-25-13

## SOIL

### Soil Survey Data:

Map Unit Name: Alderwood gravelly sandy loam 15 to 30% slopes Drainage Class: Moderately well drained  
Field Observations Confirm Mapped Type?

Taxonomy (Subgroup): Entic Durochrepts Yes  No  NA

### Profile Description:

Depth (Inches)	Horizon Designation	Matrix Color (Munsell Moist)	Mottle Color (Munsell Moist)	Mottle Abundance/Contrast	Texture, Concretions, Rhizospheres, etc.
0-12	A	10YR 3/2	5YR 4/6	few, fine, prominent	gravelly sandy loam
12-16	B	10YR 3/1	5YR 4/6	few, fine, prominent	gravelly sandy loam

### Hydric Soil Indicators:

- |   |  |
|---|--|
| <input type="checkbox"/> Histosol                               | <input type="checkbox"/> Listed on Hydric Soils List                 |
| <input type="checkbox"/> Histic Epipedon                        | <input type="checkbox"/> Fe/Mn Concretions                           |
| <input type="checkbox"/> Sulfidic Odor                          | <input type="checkbox"/> Organic Streaking in Sandy Soils            |
| <input type="checkbox"/> Aquic or Peraguc Moisture Regime       | <input checked="" type="checkbox"/> Mottles (Redoximorphic Features) |
| <input type="checkbox"/> Reducing Conditions                    | <input type="checkbox"/> Other (Explain in Remarks)                  |
| <input checked="" type="checkbox"/> Gleyed or Low-Chroma Colors |  |
| <input type="checkbox"/> High Organic Content in Surface Layer  |  |

Remarks (Describe soil disturbances, local variations, etc.):  
*Chroma 2 soil with redoximorphic features indicate hydric soils.*

## WETLAND DETERMINATION

Hydrophytic Vegetation Present?	Yes <input type="checkbox"/> No <input checked="" type="checkbox"/>	Is this Sampling Point Within a Wetland? Yes <input type="checkbox"/> No <input checked="" type="checkbox"/>
Hydric Soils Present?	Yes <input checked="" type="checkbox"/> No <input type="checkbox"/>	
Wetland Hydrology Present?	Yes <input type="checkbox"/> No <input checked="" type="checkbox"/>	

Remarks  
*Hydrophytic vegetation and wetland hydrology criteria are not satisfied. Therefore, the sample plot is not located in a wetland.*

Data Plot #: 23B-SP1  
 Wetland: 23B

## WETLAND DETERMINATION (Modified from: 1987 ACOE Wetlands Delineation Manual)

Project/Site: ELST Re-delineation Date: 10/31/2007 Revisited 09-20-13  
 Applicant/Owner: King County County: King County  
 Investigator: Michael Muscari/Laura Brock State: WA  
 1987 Method  1997 WA St. Method Community ID: PEM 09-20-13 - PSS  
 Do Normal Circumstances exist on the site? Yes X No \_\_\_\_\_ Field Plot ID: 23B-SP1  
 Is the site significantly disturbed (Atypical Situation)? Yes \_\_\_\_\_ No X  
 Is the area a potential Problem Area? Yes \_\_\_\_\_ No X

**Remarks** (Explain sample location, disturbances, problem areas):

*Sample plot showed hydro at bottom slope, we assumed slope had hydro based on wetland description. This sample plot is located approximately 10' west of flag 23B-3.*

09-20-13 Observations - Observed from trail.

**VEGETATION** (✓ Dominant species are checked)

Plant Species	% Cover	Stratum	Indicator
✓ 1. <u>Athyrium filix-femina</u>	<u>20</u>	<u>Herb</u>	<u>FAC</u>
✓ 2. <u>Equisetum arvense</u>	<u>30</u>	<u>Herb</u>	<u>FAC</u>
3. <u>Equisetum hyemale</u>	<u>10</u>	<u>Herb</u>	<u>FACW</u>
4. <u>loosestrife (yellow?)</u>	<u>5</u>	<u>Herb</u>	<u>FACW</u>
✓ 5. <u>Lotus corniculatus</u>	<u>30</u>	<u>Herb</u>	<u>FAC</u>
✓ 6. <u>Scirpus microcarpus</u>	<u>20</u>	<u>Herb</u>	<u>OBL</u>
7. <u>Alnus rubra (5' tall)</u>	<u>5</u>	<u>Shrub</u>	<u>FAC</u>
8. <u>Fraxinus latifolia (5' tall)</u>	<u>10</u>	<u>Shrub</u>	<u>FACW</u>
9. <u>Populus balsamifera (5' tall)</u>	<u>10</u>	<u>Shrub</u>	<u>FAC</u>
✓ 10. <u>Thuja plicata (15' tall)</u>	<u>25</u>	<u>Tree</u>	<u>FAC</u>

**09-20-13 Observations**

Athyrium filix-femina 20%  
 Equisetum arvense 30%  
 Equisetum hyemale 10%  
 loosestrife (yellow?) 5%  
 Lotus corniculatus 30%  
 Scirpus microcarpus 20%  
 Alnus rubra 15%  
 Fraxinus latifolia 15%  
 Populus balsamifera 30%  
 Thuja plicata 30%

Percent of **Dominant Species** that are OBL, FACW, or FAC (except FAC-). Include species noted (\*) as showing morphological adaptations to wetlands. "T" indicates trace. 100

**Remarks** (Describe disturbances, relevant local variations, seasonal effects, etc.):

*Somewhat undisturbed PEM on "bench" next to lake. The percent of dominant species that are hydrophytic is greater than 50 percent. Hydrophytic vegetation criterion is satisfied.*

**HYDROLOGY**

**Recorded Data** (Describe in Remarks):

\_\_\_\_\_ Stream, Lake, or Tide Gage  
 \_\_\_\_\_ Aerial Photograph  
 \_\_\_\_\_ Other  
X No Recorded Data Available

**Wetland Hydrology Indicators** (Describe in Remarks):

Primary Indicators:  
 \_\_\_\_\_ Inundated  
X Saturated in Upper 12 inches  
 \_\_\_\_\_ Water Marks  
 \_\_\_\_\_ Drift Lines  
 \_\_\_\_\_ Sediment Deposits  
 \_\_\_\_\_ Drainage Patterns in Wetlands

**Field Observations:**

Depth of Surface Water: none (in.)  
 Depth to Free Water in Pit: 11 (in.)  
 Depth to Saturated Soil: surface (in.)

Secondary Indicators (2 or more required):  
 \_\_\_\_\_ Oxidized Rhizospheres in Upper 12 inches  
 \_\_\_\_\_ Water-Stained Leaves  
 \_\_\_\_\_ Local Soil Survey Data  
 \_\_\_\_\_ Other (Explain in Remarks)

**Remarks** (As relevant, describe recent precipitation, hydrologic modifications, local variations, etc.):

*Saturation to the surface satisfies wetland hydrology criterion.*

# Parametrix

Data Plot #: 23B-SP1  
Wetland: 23B

Project/Site: ELST Re-delineation Date: 10/31/2007 Revisited 09-20-13

## SOIL

### Soil Survey Data:

Map Unit Name: Alderwood gravelly sandy loam, 6 to 15 % slopes Drainage Class: Moderately well drained  
Field Observations Confirm Mapped Type?

Taxonomy (Subgroup): Entic Durochrepts Yes  No  NA

### Profile Description:

Depth (Inches)	Horizon Designation	Matrix Color (Munsell Moist)	Mottle Color (Munsell Moist)	Mottle Abundance/Contrast	Texture, Concretions, Rhizospheres, etc.
0-10	A	10YR 2/1	none	none	mucky loam
10-16	B	2.5YR 4/1	none	none	gravelly sand

### Hydric Soil Indicators:

- |   |   |
|---|---|
| <input type="checkbox"/> Histosol   | <input type="checkbox"/> Listed on Hydric Soils List      |
| <input type="checkbox"/> Histic Epipedon                                  | <input type="checkbox"/> Fe/Mn Concretions                |
| <input checked="" type="checkbox"/> Sulfidic Odor                         | <input type="checkbox"/> Organic Streaking in Sandy Soils |
| <input type="checkbox"/> Aquic or Peraguc Moisture Regime                 | <input type="checkbox"/> Mottles (Redoximorphic Features) |
| <input type="checkbox"/> Reducing Conditions                              | <input type="checkbox"/> Other (Explain in Remarks)       |
| <input checked="" type="checkbox"/> Gleyed or Low-Chroma Colors           |   |
| <input checked="" type="checkbox"/> High Organic Content in Surface Layer |   |

Remarks (Describe soil disturbances, local variations, etc.):  
*Many undecomposed plant parts. A low chroma of 1 indicates hydric soil.*

## WETLAND DETERMINATION

Hydrophytic Vegetation Present? Yes  No  Is this Sampling Point Within a Wetland?  
Hydric Soils Present? Yes  No  Yes  No   
Wetland Hydrology Present? Yes  No

### Remarks

*Wetland vegetation, hydrology, and soil criteria are met. Therefore, the sample plot is located in a wetland.*

Exhibit 16  
SSDP2016-00415  
000873

# Parametrix

Data Plot #: 23B-SP2  
 Wetland: Upland near 23B

## WETLAND DETERMINATION (Modified from: 1987 ACOE Wetlands Delineation Manual)

Project/Site: ELST Re-delineation Date: 10/31/2007 Revisited 09-20-13  
 Applicant/Owner: King County County: King County  
 Investigator: Michael Muscari/Laura Brock State: WA  
 1987 Method  1977 WA St. Method Community ID: Upland Shrub  
 Do Normal Circumstances exist on the site? Yes X No \_\_\_\_\_ Field Plot ID: 23B-SP2  
 Is the site significantly disturbed (Atypical Situation)? Yes \_\_\_\_\_ No X  
 Is the area a potential Problem Area? Yes \_\_\_\_\_ No X

**Remarks** (Explain sample location, disturbances, problem areas):  
*This sample plot is located approximately 10' southeast of flag 3.*

**09-20-13 Observations** - Observed from trail.

### VEGETATION (✓ Dominant species are checked)

Plant Species	% Cover	Stratum	Indicator
1. _____	_____	_____	_____
✓ 2. <u>Convolvulus spp.</u>	<u>20</u>	<u>Herb</u>	<u>NL</u>
✓ 3. <u>Equisetum hyemale</u>	<u>30</u>	<u>Herb</u>	<u>FACW</u>
4. <u>Equisetum telmateia</u>	<u>15</u>	<u>Herb</u>	<u>FACW</u>
5. <u>Fraxinus latifolia</u>	<u>5</u>	<u>Shrub</u>	<u>FACW</u>
6. <u>Rosa pisocarpa</u>	<u>10</u>	<u>Shrub</u>	<u>FAC</u>
✓ 7. <u>Rubus armeniacus</u>	<u>70</u>	<u>Shrub</u>	<u>FACU</u>
✓ 8. <u>Rubus ursinus</u>	<u>30</u>	<u>Shrub</u>	<u>FACU</u>

### 09-20-13 Observations

Convolvulus spp. 10%  
 Equisetum hyemale 20%  
 Equisetum telmateia 15%  
 Fraxinus latifolia 5%  
 Rosa pisocarpa 10%  
 Rubus armeniacus 70%  
 Rubus ursinus 30%  
 Thuja plicata 5%

Percent of **Dominant Species** that are OBL, FACW, or FAC (except FAC-). Include species noted (\*) as showing morphological adaptations to wetlands. "T" indicates trace. 50

**Remarks** (Describe disturbances, relevant local variations, seasonal effects, etc.):  
*Equisetum hyemale, Rubus armeniacus, Rubus ursinus dominate upland vegetation in the vicinity of the plot. Rubus parviflorus, bracken fern, sword fern are also present along upland boundary. The percent of dominant species that are hydrophytic is not greater than 50 percent. Hydrophytic vegetation criterion is not satisfied.*

### HYDROLOGY

**Recorded Data** (Describe in Remarks):  
 \_\_\_\_\_ Stream, Lake, or Tide Gage  
 \_\_\_\_\_ Aerial Photograph  
 \_\_\_\_\_ Other  
X No Recorded Data Available

**Wetland Hydrology Indicators** (Describe in Remarks):  
 Primary Indicators:  
 \_\_\_\_\_ Inundated  
 \_\_\_\_\_ Saturated in Upper 12 inches  
 \_\_\_\_\_ Water Marks  
 \_\_\_\_\_ Drift Lines  
 \_\_\_\_\_ Sediment Deposits  
 \_\_\_\_\_ Drainage Patterns in Wetlands

**Field Observations:**

Depth of Surface Water: none (in.)  
 Depth to Free Water in Pit: none (in.)  
 Depth to Saturated Soil: none (in.)

Secondary Indicators (2 or more required):  
 \_\_\_\_\_ Oxidized Rhizospheres in Upper 12 inches  
 \_\_\_\_\_ Water-Stained Leaves  
 \_\_\_\_\_ Local Soil Survey Data  
 \_\_\_\_\_ Other (Explain in Remarks)

**Remarks** (As relevant, describe recent precipitation, hydrologic modifications, local variations, etc.):  
*No primary or secondary indicators of hydrology are present. Wetland hydrology criterion is not satisfied.*

# Parametrix

Data Plot #: 23B-SP2  
Wetland: Upland near 23B

Project/Site: ELST Re-delineation Date: 10/31/2007 Revised 09-20-13

## SOIL

### Soil Survey Data:

Map Unit Name: Alderwood gravelly sandy loam 6 to 15% slopes Drainage Class: Moderately well drained  
Field Observations Confirm Mapped Type?

Taxonomy (Subgroup): Entic Durochrepts Yes  No  NA

### Profile Description:

Depth (Inches)	Horizon Designation	Matrix Color (Munsell Moist)	Mottle Color (Munsell Moist)	Mottle Abundance/Contrast	Texture, Concretions, Rhizospheres, etc.
0-10	A	10YR 2/1	none	none	gravelly sandy loam
10-16	B	10YR 4/3	none	none	sandy loam

### Hydric Soil Indicators:

- |  |   |
|--|---|
| <input type="checkbox"/> Histosol                              | <input type="checkbox"/> Listed on Hydric Soils List      |
| <input type="checkbox"/> Histic Epipedon                       | <input type="checkbox"/> Fe/Mn Concretions                |
| <input type="checkbox"/> Sulfidic Odor                         | <input type="checkbox"/> Organic Streaking in Sandy Soils |
| <input type="checkbox"/> Aquic or Peraguc Moisture Regime      | <input type="checkbox"/> Mottles (Redoximorphic Features) |
| <input type="checkbox"/> Reducing Conditions                   | <input type="checkbox"/> Other (Explain in Remarks)       |
| <input type="checkbox"/> Gleyed or Low-Chroma Colors           |   |
| <input type="checkbox"/> High Organic Content in Surface Layer |   |

Remarks (Describe soil disturbances, local variations, etc.):  
*No indicators of hydric soil were present. Hydric soil criterion is not satisfied.*

## WETLAND DETERMINATION

Hydrophytic Vegetation Present? Yes  No  Is this Sampling Point Within a Wetland?  
Hydric Soils Present? Yes  No  Yes  No   
Wetland Hydrology Present? Yes  No

Remarks  
*Hydrophytic vegetation, wetland hydrology, and wetland soil criteria are not satisfied. The sample plot is not located in a wetland.*



Data Plot #: 23C-SP1  
Wetland: 23C

## WETLAND DETERMINATION (Modified from: 1987 ACOE Wetlands Delineation Manual)

Project/Site: ELST Re-delineation Date: 11/7/2007 Revisited 09-20-13  
Applicant/Owner: King County County: King  
Investigator: Erik Christensen, Chip Maney State: WA  
 1987 Method  1997 WA St. Method Community ID: PSS  
Do Normal Circumstances exist on the site? Yes X No \_\_\_\_\_ Field Plot ID: 23C-SP1  
Is the site significantly disturbed (Atypical Situation)? Yes \_\_\_\_\_ No X  
Is the area a potential Problem Area? Yes \_\_\_\_\_ No X

**Remarks** (Explain sample location, disturbances, problem areas):

*This sample plot is located 5 feet west of flag W23C-2 and 10 feet north of a cherry tree.*

**VEGETATION** (✓ Dominant species are checked)

Plant Species	% Cover	Stratum	Indicator
✓ 1. <u>Athyrium filix-femina</u>	<u>70</u>	<u>H</u>	<u>FAC</u>
✓ 2. <u>Lonicera involucrata</u>	<u>20</u>	<u>S</u>	<u>FAC</u>
3. <u>Rubus armeniacus</u>	<u>15</u>	<u>S</u>	<u>FACU</u>
✓ 4. <u>Rubus spectabilis</u>	<u>30</u>	<u>S</u>	<u>FAC+</u>

**09-20-13 Observations**

Athyrium filix-femina 70%  
Lonicera involucrata 50%  
Rubus armeniacus 30%  
Rubus spectabilis 15%

Percent of **Dominant Species** that are OBL, FACW, or FAC (except FAC-). Include species noted (\*) as showing morphological adaptations to wetlands. "T" indicates trace. 100

**Remarks** (Describe disturbances, relevant local variations, seasonal effects, etc.):

*A Prunus sp. was rooted outside of the wetland but was over hanging to provide 15 percent cover. The percent of dominant species that are hydrophytic is greater than 50 percent. Hydrophytic vegetation criterion is satisfied.*

## HYDROLOGY

**Recorded Data** (Describe in Remarks):

\_\_\_\_\_  
Stream, Lake, or Tide Gage  
\_\_\_\_\_  
Aerial Photograph  
\_\_\_\_\_  
Other  
X  
No Recorded Data Available

**Wetland Hydrology Indicators** (Describe in Remarks):

Primary Indicators:

\_\_\_\_\_  
Inundated  
X  
Saturated in Upper 12 inches  
\_\_\_\_\_  
Water Marks  
\_\_\_\_\_  
Drift Lines  
\_\_\_\_\_  
Sediment Deposits  
\_\_\_\_\_  
Drainage Patterns in Wetlands

Secondary Indicators (2 or more required):

\_\_\_\_\_  
Oxidized Rhizospheres in Upper 12 inches  
\_\_\_\_\_  
Water-Stained Leaves  
\_\_\_\_\_  
Local Soil Survey Data  
\_\_\_\_\_  
Other (Explain in Remarks)

**Field Observations:**

Depth of Surface Water: none (in.)  
Depth to Free Water in Pit: 12 (in.)  
Depth to Saturated Soil: 9 (in.)

**Remarks** (As relevant, describe recent precipitation, hydrologic modifications, local variations, etc.):

*Saturation in the upper 12 inches satisfies wetland hydrology criterion.*

**09-20-13 Observations** - No saturation. Standing water in trail-side ditch.

# Parametrix

Data Plot #: 23C-SP1  
Wetland: 23C

Project/Site: ELST Re-delineation Date: 11/7/2007 Revisited 09-20-13

## SOIL

### Soil Survey Data:

Map Unit Name: Alderwood gravelly sandy loam 6 to 15% slopes Drainage Class: Moderately well drained  
Field Observations Confirm Mapped Type?

Taxonomy (Subgroup): Entic Durochrepts Yes  No  NA

### Profile Description:

Depth (Inches)	Horizon Designation	Matrix Color (Munsell Moist)	Mottle Color (Munsell Moist)	Mottle Abundance/Contrast	Texture, Concretions, Rhizospheres, etc.
0-11	A	10YR 2/1	none	none	loam
11-18	B	5Y 4/1	7.5YR 4/6	common, medium, prominent	loamy clay <span style="border: 1px solid red; padding: 2px;">09-20-13 - clay loam</span>

### Hydric Soil Indicators:

- |   |   |
|---|---|
| <input type="checkbox"/> Histosol                               | <input type="checkbox"/> Listed on Hydric Soils List      |
| <input type="checkbox"/> Histic Epipedon                        | <input type="checkbox"/> Fe/Mn Concretions                |
| <input type="checkbox"/> Sulfidic Odor                          | <input type="checkbox"/> Organic Streaking in Sandy Soils |
| <input type="checkbox"/> Aquic or Peraguc Moisture Regime       | <input type="checkbox"/> Mottles (Redoximorphic Features) |
| <input type="checkbox"/> Reducing Conditions                    | <input type="checkbox"/> Other (Explain in Remarks)       |
| <input checked="" type="checkbox"/> Gleyed or Low-Chroma Colors |   |
| <input type="checkbox"/> High Organic Content in Surface Layer  |   |

Remarks (Describe soil disturbances, local variations, etc.): 09-20-13 Observations - Disturbed soil. Carbon/partially decomposed woody matter and gravel in lower layer.

*Chroma 1 soil matix indicates hydric soils. Hydric soil criterion is satisfied.*

## WETLAND DETERMINATION

Hydrophytic Vegetation Present?	Yes <input checked="" type="checkbox"/> No <input type="checkbox"/>	Is this Sampling Point Within a Wetland?
Hydric Soils Present?	Yes <input checked="" type="checkbox"/> No <input type="checkbox"/>	Yes <input checked="" type="checkbox"/> No <input type="checkbox"/>
Wetland Hydrology Present?	Yes <input checked="" type="checkbox"/> No <input type="checkbox"/>	

### Remarks

*Wetland vegetation, hydrology, and soil criteria are met. Therefore, the sample plot is located in a wetland.*

Data Plot #: 23C-SP2  
 Wetland: Upland near 23C

## WETLAND DETERMINATION (Modified from: 1987 ACOE Wetlands Delineation Manual)

Project/Site: ELST Re-delineation Date: 11/7/2007 Revisited 09-20-13  
 Applicant/Owner: King County County: King  
 Investigator: Erik Christensen, Chip Maney State: WA  
 1987 Method  1977 WA St. Method Community ID: Upland Forest  
 Do Normal Circumstances exist on the site? Yes X No        Field Plot ID: 23C-SP2  
 Is the site significantly disturbed (Atypical Situation)? Yes        No X  
 Is the area a potential Problem Area? Yes        No X

**Remarks** (Explain sample location, disturbances, problem areas):  
*This sample plot is located 15 feet south/southwest of flag W23C-1 and 12 feet north/northeast of the largest cherry tree.*

### VEGETATION (✓ Dominant species are checked)

	Plant Species	% Cover	Stratum	Indicator
1.	<u>Equisetum telmateia</u>	<u>15</u>	<u>H</u>	<u>FACW</u>
2.	<u>Polystichum munitum</u>	<u>10</u>	<u>H</u>	<u>FACU</u>
✓ 3.	<u>Rubus armeniacus</u>	<u>90</u>	<u>S</u>	<u>FACU</u>
✓ 4.	<u>Prunus spp.</u>	<u>66</u>	<u>T</u>	<u>      </u>

Percent of **Dominant Species** that are OBL, FACW, or FAC (except FAC-). Include species noted (\*) as showing morphological adaptations to wetlands. "T" indicates trace. 0

**Remarks** (Describe disturbances, relevant local variations, seasonal effects, etc.):  
*The percent of dominant species that are hydrophytic is not greater than 50 percent. Hydrophytic vegetation criterion is not satisfied.*

### HYDROLOGY

**Recorded Data** (Describe in Remarks):

       Stream, Lake, or Tide Gage  
       Aerial Photograph  
       Other  
  X   No Recorded Data Available

**Field Observations:**

Depth of Surface Water: none (in.)  
 Depth to Free Water in Pit: none (in.)  
 Depth to Saturated Soil: 14 (in.)

**Wetland Hydrology Indicators** (Describe in Remarks):

Primary Indicators:  
       Inundated  
       Saturated in Upper 12 inches  
       Water Marks  
       Drift Lines  
       Sediment Deposits  
       Drainage Patterns in Wetlands

Secondary Indicators (2 or more required):  
       Oxidized Rhizospheres in Upper 12 inches  
       Water-Stained Leaves  
       Local Soil Survey Data  
       Other (Explain in Remarks)

**Remarks** (As relevant, describe recent precipitation, hydrologic modifications, local variations, etc.):  
*No indicators of wetland hydrology present. Hydric soil criteria is not satisfied.*

# Parametrix

Data Plot #: 23C-SP2  
Wetland: Upland near 23C

Project/Site: ELST Re-delineation Date: 11/7/2007 Revisited 09-20-13

## SOIL

### Soil Survey Data:

Map Unit Name: Alderwood gravelly sandy loam 6 to 15% slopes Drainage Class: Moderately well drained  
Field Observations Confirm Mapped Type?

Taxonomy (Subgroup): Entic Durochrepts Yes  No  NA

### Profile Description:

Depth (Inches)	Horizon Designation	Matrix Color (Munsell Moist)	Mottle Color (Munsell Moist)	Mottle Abundance/Contrast	Texture, Concretions, Rhizospheres, etc.
0-9	A	10YR 2/1	none	none	loam
9-18	B	5Y 4/1	10YR 4/6	medium, common, prominent	sandy loam

### Hydric Soil Indicators:

- |   |  |
|---|--|
| <input type="checkbox"/> Histosol                               | <input type="checkbox"/> Listed on Hydric Soils List                 |
| <input type="checkbox"/> Histic Epipedon                        | <input type="checkbox"/> Fe/Mn Concretions                           |
| <input type="checkbox"/> Sulfidic Odor                          | <input type="checkbox"/> Organic Streaking in Sandy Soils            |
| <input type="checkbox"/> Aquic or Peraguc Moisture Regime       | <input checked="" type="checkbox"/> Mottles (Redoximorphic Features) |
| <input type="checkbox"/> Reducing Conditions                    | <input type="checkbox"/> Other (Explain in Remarks)                  |
| <input checked="" type="checkbox"/> Gleyed or Low-Chroma Colors |  |
| <input type="checkbox"/> High Organic Content in Surface Layer  |  |

Remarks (Describe soil disturbances, local variations, etc.):  
*Chroma 1 soil matrix and the presence of redoximorphic features indicate hydric soils.*

## WETLAND DETERMINATION

Hydrophytic Vegetation Present?	Yes <input type="checkbox"/> No <input checked="" type="checkbox"/>	Is this Sampling Point Within a Wetland? Yes <input type="checkbox"/> No <input checked="" type="checkbox"/>
Hydric Soils Present?	Yes <input checked="" type="checkbox"/> No <input type="checkbox"/>	
Wetland Hydrology Present?	Yes <input type="checkbox"/> No <input checked="" type="checkbox"/>	

Remarks  
*Hydrophytic vegetation and wetland hydrology criteria are not satisfied. Therefore, the sample plot is not located in a wetland.*

Data Plot #: 24A-SP1  
 Wetland: 24A

## WETLAND DETERMINATION (Modified from: 1987 ACOE Wetlands Delineation Manual)

Project/Site: ELST Re-delineation Date: 11/7/2007 Revised 09-20-13  
 Applicant/Owner: King County County: King  
 Investigator: Chip Maney State: WA  
 1987 Method  1997 WA St. Method Community ID: PSS  
 Do Normal Circumstances exist on the site? Yes X No \_\_\_\_\_ Field Plot ID: 24A-SP1  
 Is the site significantly disturbed (Atypical Situation)? Yes \_\_\_\_\_ No X  
 Is the area a potential Problem Area? Yes \_\_\_\_\_ No X

**Remarks** (Explain sample location, disturbances, problem areas):

*This sample plot is located 30 feet east from flag W24A-2 and 10 feet into a willow thicket. No location of upland plot is available for the wetland.*

### VEGETATION (✓ Dominant species are checked)

	Plant Species	% Cover	Stratum	Indicator
1.	<u>Equisetum telmateia</u>	<u>5</u>	<u>H</u>	<u>FACW</u>
2.	<u>Glyceria striata</u>	<u>5</u>	<u>H</u>	<u>OBL</u>
3.	<u>Phalaris arundinacea</u>	<u>trace</u>	<u>H</u>	<u>FACW</u>
✓ 4.	<u>Cornus sericea</u>	<u>20</u>	<u>S</u>	<u>FACW</u>
5.	<u>Rubus armeniacus</u>	<u>2</u>	<u>S</u>	<u>FACU</u>
✓ 6.	<u>Salix scouleriana</u>	<u>100</u>	<u>S</u>	<u>FAC</u>
7.	<u>Alnus rubra</u>	<u>10</u>	<u>T</u>	<u>FAC</u>

Percent of **Dominant Species** that are OBL, FACW, or FAC (except FAC-). Include species noted (\*) as showing morphological adaptations to wetlands. "T" indicates trace. 100

**Remarks** (Describe disturbances, relevant local variations, seasonal effects, etc.):

*The percent of dominant species that are hydrophytic is greater than 50 percent. Hydrophytic vegetation criterion is satisfied.*

### HYDROLOGY

**Recorded Data** (Describe in Remarks):

\_\_\_\_\_  
 Stream, Lake, or Tide Gage  
 \_\_\_\_\_  
 Aerial Photograph  
 \_\_\_\_\_  
 Other  
 \_\_\_\_\_  
 X No Recorded Data Available

**Wetland Hydrology Indicators** (Describe in Remarks):

Primary Indicators:  
 \_\_\_\_\_ Inundated  
 X \_\_\_\_\_ Saturated in Upper 12 inches  
 \_\_\_\_\_ Water Marks  
 \_\_\_\_\_ Drift Lines  
 \_\_\_\_\_ Sediment Deposits  
 \_\_\_\_\_ Drainage Patterns in Wetlands

**Field Observations:**

Depth of Surface Water: none (in.)  
 Depth to Free Water in Pit: 13 (in.)  
 Depth to Saturated Soil: 4 (in.)

Secondary Indicators (2 or more required):  
 \_\_\_\_\_ Oxidized Rhizospheres in Upper 12 inches  
 \_\_\_\_\_ Water-Stained Leaves  
 \_\_\_\_\_ Local Soil Survey Data  
 \_\_\_\_\_ Other (Explain in Remarks)

**Remarks** (As relevant, describe recent precipitation, hydrologic modifications, local variations, etc.):

*Saturation in the upper 12 inches satisfies wetland hydrology criterion.*

**09-20-13 Observations** - Shallow inundation.

# Parametrix

Data Plot #: 24A-SP1  
Wetland: 24A

Project/Site: ELST Re-delineation Date: 11/7/2007 Revisited 09-20-13

## SOIL

### Soil Survey Data:

Map Unit Name: Seattle muck Drainage Class: very poorly drained  
Field Observations Confirm Mapped Type?

Taxonomy (Subgroup): Typic Medihemists Yes  No  NA

### Profile Description:

Depth (Inches)	Horizon Designation	Matrix Color (Munsell Moist)	Mottle Color (Munsell Moist)	Mottle Abundance/Contrast	Texture, Concretions, Rhizospheres, etc.
0-12	A	10YR 2/1	none	none	silt loam
12-18	A2	10YR 3/1	none	none	sandy loam

### Hydric Soil Indicators:

- |   |   |
|---|---|
| <input type="checkbox"/> Histosol                               | <input type="checkbox"/> Listed on Hydric Soils List      |
| <input type="checkbox"/> Histic Epipedon                        | <input type="checkbox"/> Fe/Mn Concretions                |
| <input type="checkbox"/> Sulfidic Odor                          | <input type="checkbox"/> Organic Streaking in Sandy Soils |
| <input type="checkbox"/> Aquic or Peraguc Moisture Regime       | <input type="checkbox"/> Mottles (Redoximorphic Features) |
| <input type="checkbox"/> Reducing Conditions                    | <input type="checkbox"/> Other (Explain in Remarks)       |
| <input checked="" type="checkbox"/> Gleyed or Low-Chroma Colors |   |
| <input type="checkbox"/> High Organic Content in Surface Layer  |   |

Remarks (Describe soil disturbances, local variations, etc.):  
*Chroma 1 soil indicate hydric soils.*

## WETLAND DETERMINATION

Hydrophytic Vegetation Present? Yes  No  Is this Sampling Point Within a Wetland?  
Hydric Soils Present? Yes  No  Yes  No   
Wetland Hydrology Present? Yes  No

Remarks  
*Wetland vegetation, hydrology, and soil criteria are met. Therefore, the sample plot is located in a wetland.*

Data Plot #: 24B-SP1  
 Wetland: 24B

## WETLAND DETERMINATION (Modified from: 1987 ACOE Wetlands Delineation Manual)

Project/Site: ELST Re-delineation Date: 11/2/2007 Revisited 09-25-13  
 Applicant/Owner: King County County: King County  
 Investigator: Linda Krippner/Rachel Hulscher State: WA  
 1987 Method  1997 WA St. Method Community ID: PFO  
 Do Normal Circumstances exist on the site? Yes X No \_\_\_\_\_ Field Plot ID: 24B-SP1  
 Is the site significantly disturbed (Atypical Situation)? Yes \_\_\_\_\_ No X  
 Is the area a potential Problem Area? Yes \_\_\_\_\_ No X

**Remarks** (Explain sample location, disturbances, problem areas):  
*This sample plot is located approximately 10 feet northeast of Flag 24B-5.*

### VEGETATION (✓ Dominant species are checked)

Plant Species	% Cover	Stratum	Indicator
✓ 1. <u>Equisetum telmateia</u>	<u>30</u>	<u>Herb</u>	<u>FACW</u>
✓ 2. <u>Phalaris arundinacea</u>	<u>50</u>	<u>Herb</u>	<u>FACW</u>
✓ 3. <u>Urtica dioica</u>	<u>40</u>	<u>Herb</u>	<u>FAC+</u>
4. <u>Fraxinus latifolia</u>	<u>2</u>	<u>Shrub</u>	<u>FACW</u>
✓ 5. <u>Rubus armeniacus</u>	<u>40</u>	<u>Shrub</u>	<u>FACU</u>
6. <u>Rubus spectabilis</u>	<u>10</u>	<u>Shrub</u>	<u>FAC+</u>
7. <u>Alnus rubra</u>	<u>5</u>	<u>Tree</u>	<u>FAC</u>
✓ 8. <u>Salix sepulcralis</u>	<u>70</u>	<u>Tree</u>	<u>FAC+</u>

**09-25-13 Observations**  
 Equisetum telmateia 30%  
 Phalaris arundinacea 5%  
 Urtica dioica 40%  
 Fraxinus latifolia 2%  
 Rubus armeniacus 40%  
 Rubus spectabilis 10%  
 Alnus rubra 5%  
 Salix sepulcralis (fallen branches) 40%  
 Populus balsamifera 5%  
 Calystegia sepium 40%

Percent of **Dominant Species** that are OBL, FACW, or FAC (except FAC-). Include species noted (\*) as showing morphological adaptations to wetlands. "T" indicates trace. 80

**09-25-13 Observations** - Few, small, recently planted trees in vicinity (e.g., Thuja plicata, Cedrus deodora, and other conifers).

**Remarks** (Describe disturbances, relevant local variations, seasonal effects, etc.):  
*The percent of dominant species that are hydrophytic is greater than 50 percent. Hydrophytic vegetation criterion is satisfied.*

### HYDROLOGY

**Recorded Data** (Describe in Remarks):  
 \_\_\_\_\_ Stream, Lake, or Tide Gage  
 \_\_\_\_\_ Aerial Photograph  
 \_\_\_\_\_ Other  
X No Recorded Data Available

**Wetland Hydrology Indicators** (Describe in Remarks):

Primary Indicators:  
 \_\_\_\_\_ Inundated  
X Saturated in Upper 12 inches  
 \_\_\_\_\_ Water Marks  
 \_\_\_\_\_ Drift Lines  
 \_\_\_\_\_ Sediment Deposits  
 \_\_\_\_\_ Drainage Patterns in Wetlands

**Field Observations:**

Depth of Surface Water: none (in.)  
 Depth to Free Water in Pit: none (in.)  
 Depth to Saturated Soil: 10 (in.)

Secondary Indicators (2 or more required):  
 \_\_\_\_\_ Oxidized Rhizospheres in Upper 12 inches  
 \_\_\_\_\_ Water-Stained Leaves  
 \_\_\_\_\_ Local Soil Survey Data  
 \_\_\_\_\_ Other (Explain in Remarks)

**Remarks** (As relevant, describe recent precipitation, hydrologic modifications, local variations, etc.):  
*Soil saturation in the upper 12 inches satisfies wetland hydrology criterion. A ponded area is located approximately 25 feet to the southwest.*

**09-25-13 Observations** - No saturated soils to at least 20 inches below the surface.

# Parametrix

Data Plot #: 24B-SP1  
Wetland: 24B

Project/Site: ELST Re-delineation Date: 11/2/2007 Revisited 09-25-13

## SOIL

### Soil Survey Data:

Map Unit Name: Norma Sandy Loam Drainage Class: Poorly drained  
Field Observations Confirm Mapped Type?  
Taxonomy (Subgroup): Fluventic Humaquepts Yes  No  NA

### Profile Description:

Depth (Inches)	Horizon Designation	Matrix Color (Munsell Moist)	Mottle Color (Munsell Moist)	Mottle Abundance/Contrast	Texture, Concretions, Rhizospheres, etc.
0-16	A	10YR 2/1	none	none	silt loam

### Hydric Soil Indicators:

- |   |   |
|---|---|
| <input type="checkbox"/> Histosol                               | <input type="checkbox"/> Listed on Hydric Soils List      |
| <input type="checkbox"/> Histic Epipedon                        | <input type="checkbox"/> Fe/Mn Concretions                |
| <input type="checkbox"/> Sulfidic Odor                          | <input type="checkbox"/> Organic Streaking in Sandy Soils |
| <input type="checkbox"/> Aquic or Peraguc Moisture Regime       | <input type="checkbox"/> Mottles (Redoximorphic Features) |
| <input type="checkbox"/> Reducing Conditions                    | <input type="checkbox"/> Other (Explain in Remarks)       |
| <input checked="" type="checkbox"/> Gleyed or Low-Chroma Colors |   |
| <input type="checkbox"/> High Organic Content in Surface Layer  |   |

Remarks (Describe soil disturbances, local variations, etc.):  
*Low chroma soil matrix indicates hydric soils.*

## WETLAND DETERMINATION

Hydrophytic Vegetation Present? Yes  No  Is this Sampling Point Within a Wetland?  
Hydric Soils Present? Yes  No  Yes  No   
Wetland Hydrology Present? Yes  No

### Remarks

*Wetland vegetation, hydrology, and soil criteria are met. Therefore, the sample plot is located in a wetland.*

Exhibit 16  
SSDP2016-00415  
000883



Data Plot #: 24B-SP2  
 Wetland: Upland near 24B

## WETLAND DETERMINATION (Modified from: 1987 ACOE Wetlands Delineation Manual)

Project/Site: ELST Re-delineation Date: 11/2/2007 Revised 09-25-13  
 Applicant/Owner: King County County: King County  
 Investigator: Linda Krippner/Rachel Hulscher State: WA  
 1987 Method  1997 WA St. Method Community ID: Upland Forest  
 Do Normal Circumstances exist on the site? Yes X No        Field Plot ID: 24B-SP2  
 Is the site significantly disturbed (Atypical Situation)? Yes        No X  
 Is the area a potential Problem Area? Yes        No X

**Remarks** (Explain sample location, disturbances, problem areas):

*A large pond is located just east of Pine Lake Creek area, overall topography is sloped toward Lake Sammamish. This sample plot is located approximately 15 feet east of Flag 24B-6.*

**VEGETATION** (✓ Dominant species are checked)

Plant Species	% Cover	Stratum	Indicator
✓ 1. <u>Equisetum telmateia</u>	<u>30</u>	<u>Herb</u>	<u>FACW</u>
✓ 2. <u>Phalaris arundinacea</u>	<u>40</u>	<u>Herb</u>	<u>FACW</u>
✓ 3. <u>Physocarpus capitatus</u>	<u>30</u>	<u>Shrub</u>	<u>FACW-</u>
✓ 4. <u>Rubus armeniacus</u>	<u>50</u>	<u>Shrub</u>	<u>FACU</u>
✓ 5. <u>Rubus parviflorus</u>	<u>20</u>	<u>Shrub</u>	<u>FAC-</u>
✓ 6. <u>Alnus rubra</u>	<u>50</u>	<u>Tree</u>	<u>FAC</u>
✓ 7. <u>Populus balsamifera</u>	<u>20</u>	<u>Tree</u>	<u>FAC</u>

**09-25-13 Observations**

Equisetum telmateia 20%  
 Phalaris arundinacea 40%  
 Physocarpus capitatus 30%  
 Rubus armeniacus 50%  
 Rubus parviflorus 20%  
 Alnus rubra 50%  
 Populus balsamifera 20%  
 Corylus cornuta 30%  
 Symphoricarpos albus 20%  
 Urtica dioica 10%

Percent of **Dominant Species** that are OBL, FACW, or FAC (except FAC-). Include species noted (\*) as showing morphological adaptations to wetlands. "T" indicates trace. 71

**Remarks** (Describe disturbances, relevant local variations, seasonal effects, etc.):

*The percent of dominant species that are hydrophytic is greater than 50 percent. Hydrophytic vegetation criterion is satisfied.*

**HYDROLOGY**

**Recorded Data** (Describe in Remarks):

       Stream, Lake, or Tide Gage  
       Aerial Photograph  
       Other  
  X   No Recorded Data Available

**Wetland Hydrology Indicators** (Describe in Remarks):

Primary Indicators:  
       Inundated  
       Saturated in Upper 12 inches  
       Water Marks  
       Drift Lines  
       Sediment Deposits  
       Drainage Patterns in Wetlands

**Field Observations:**

Depth of Surface Water: none (in.)  
 Depth to Free Water in Pit: none (in.)  
 Depth to Saturated Soil: none (in.)

Secondary Indicators (2 or more required):  
       Oxidized Rhizospheres in Upper 12 inches  
       Water-Stained Leaves  
       Local Soil Survey Data  
       Other (Explain in Remarks)

**Remarks** (As relevant, describe recent precipitation, hydrologic modifications, local variations, etc.):

*Soils are dry. No primary or secondary indicators of hydrology are present. Wetland hydrology criterion is not satisfied.*

**09-25-13 Observations** - No saturated soils to at least 18 inches below the surface.

# Parametrix

Data Plot #: 24B-SP2  
Wetland: Upland near 24B

Project/Site: ELST Re-delineation Date: 11/2/2007 Revisited 09-25-13

## SOIL

### Soil Survey Data:

Map Unit Name: Seattle muck Drainage Class: very poorly drained  
Field Observations Confirm Mapped Type?

Taxonomy (Subgroup): Typic Medihemists Yes  No  NA

### Profile Description:

Depth (Inches)	Horizon Designation	Matrix Color (Munsell Moist)	Mottle Color (Munsell Moist)	Mottle Abundance/Contrast	Texture, Concretions, Rhizospheres, etc.
0-12	A	10YR 2/2	none	none	silt loam
12-16	B	10YR 5/2	none	none	silt loam

### Hydric Soil Indicators:

- |  |   |
|--|---|
| <input type="checkbox"/> Histosol                              | <input type="checkbox"/> Listed on Hydric Soils List      |
| <input type="checkbox"/> Histic Epipedon                       | <input type="checkbox"/> Fe/Mn Concretions                |
| <input type="checkbox"/> Sulfidic Odor                         | <input type="checkbox"/> Organic Streaking in Sandy Soils |
| <input type="checkbox"/> Aquic or Peraguc Moisture Regime      | <input type="checkbox"/> Mottles (Redoximorphic Features) |
| <input type="checkbox"/> Reducing Conditions                   | <input type="checkbox"/> Other (Explain in Remarks)       |
| <input type="checkbox"/> Gleyed or Low-Chroma Colors           |   |
| <input type="checkbox"/> High Organic Content in Surface Layer |   |

Remarks (Describe soil disturbances, local variations, etc.):  
*No hydric soil indicators are present. Hydric soil criterion is not satisfied.*

## WETLAND DETERMINATION

Hydrophytic Vegetation Present? Yes  No  Is this Sampling Point Within a Wetland?  
Hydric Soils Present? Yes  No  Yes  No   
Wetland Hydrology Present? Yes  No

Remarks  
*Hydric soil and wetland hydrology criteria are not met. Therefore, the sample plot is not located in a wetland.*

Data Plot #: 24C-SP1  
Wetland: 24C

## WETLAND DETERMINATION (Modified from: 1987 ACOE Wetlands Delineation Manual)

Project/Site: ELST Re-delineation Date: 11/7/2007 Revisited 09-25-13  
Applicant/Owner: King County County: King  
Investigator: Matt Maynard State: WA  
 1987 Method  1977 WA St. Method Community ID: PSS 09-25-13 - PEM  
Do Normal Circumstances exist on the site? Yes X No \_\_\_\_\_ Field Plot ID: 24C-SP1  
Is the site significantly disturbed (Atypical Situation)? Yes \_\_\_\_\_ No X  
Is the area a potential Problem Area? Yes \_\_\_\_\_ No X

**Remarks** (Explain sample location, disturbances, problem areas):  
*This sample plot is located 8 feet northeast of flag W24C-14.*

### VEGETATION (✓ Dominant species are checked)

	Plant Species	% Cover	Stratum	Indicator
1.	<u>Equisetum telmateia</u>	<u>15</u>	<u>H</u>	<u>FACW</u>
✓ 2.	<u>Phalaris arundinacea</u>	<u>90</u>	<u>H</u>	<u>FACW</u>
3.	<u>Solanum dulcamara</u>	<u>5</u>	<u>H</u>	<u>FAC+</u>
✓ 4.	<u>Rubus armeniacus</u>	<u>50</u>	<u>S</u>	<u>FACU</u>

Percent of **Dominant Species** that are OBL, FACW, or FAC (except FAC-). Include species noted (\*) as showing morphological adaptations to wetlands. "T" indicates trace. 50

**Remarks** (Describe disturbances, relevant local variations, seasonal effects, etc.):  
*Due to wetland hydrology and hydric soil observed at the sample plot, Rubus armeniacus is believed to be growing hydrophytically. Therefore, hydrophytic vegetation criterion is satisfied.*

### HYDROLOGY

**Recorded Data** (Describe in Remarks):

\_\_\_\_ Stream, Lake, or Tide Gage  
\_\_\_\_ Aerial Photograph  
\_\_\_\_ Other  
X No Recorded Data Available

**Field Observations:**

Depth of Surface Water: none (in.)  
Depth to Free Water in Pit: 11 (in.)  
Depth to Saturated Soil: surface (in.)

**Wetland Hydrology Indicators** (Describe in Remarks):

Primary Indicators:

\_\_\_\_ Inundated  
X Saturated in Upper 12 inches  
\_\_\_\_ Water Marks  
\_\_\_\_ Drift Lines  
\_\_\_\_ Sediment Deposits  
\_\_\_\_ Drainage Patterns in Wetlands

Secondary Indicators (2 or more required):

\_\_\_\_ Oxidized Rhizospheres in Upper 12 inches  
\_\_\_\_ Water-Stained Leaves  
\_\_\_\_ Local Soil Survey Data  
\_\_\_\_ Other (Explain in Remarks)

**Remarks** (As relevant, describe recent precipitation, hydrologic modifications, local variations, etc.):  
*Saturation in the upper 12 inches satisfies wetland hydrology criterion.*

# Parametrix

Data Plot #: 24C-SP1  
Wetland: 24C

Project/Site: ELST Re-delineation

Date: 11/7/2007

Revisited 09-25-13

## SOIL

### Soil Survey Data:

Map Unit Name: Seattle muck Drainage Class: very poorly drained

Field Observations Confirm Mapped Type?

Taxonomy (Subgroup): Typic Medihemists Yes  No  NA

### Profile Description:

Depth (Inches)	Horizon Designation	Matrix Color (Munsell Moist)	Mottle Color (Munsell Moist)	Mottle Abundance/Contrast	Texture, Concretions, Rhizospheres, etc.
0-6	A	10YR 2/1	none	none	loam
6-10	B1	10YR 3/1	none	none	gravelly sandy loam
10-16	B2	10YR 4/2	none	none	gravelly sandy loam
16-18	C	10YR 5/1	10YR 5/6	common, medium, prominent	silt

### Hydric Soil Indicators:

- |   |   |
|---|---|
| <input type="checkbox"/> Histosol                               | <input type="checkbox"/> Listed on Hydric Soils List      |
| <input type="checkbox"/> Histic Epipedon                        | <input type="checkbox"/> Fe/Mn Concretions                |
| <input type="checkbox"/> Sulfidic Odor                          | <input type="checkbox"/> Organic Streaking in Sandy Soils |
| <input type="checkbox"/> Aquic or Peraguc Moisture Regime       | <input type="checkbox"/> Mottles (Redoximorphic Features) |
| <input type="checkbox"/> Reducing Conditions                    | <input type="checkbox"/> Other (Explain in Remarks)       |
| <input checked="" type="checkbox"/> Gleyed or Low-Chroma Colors |   |
| <input type="checkbox"/> High Organic Content in Surface Layer  |   |

### Remarks (Describe soil disturbances, local variations, etc.):

*Chroma 1 soil indicate hydric soils.*

## WETLAND DETERMINATION

Hydrophytic Vegetation Present? Yes  No  Is this Sampling Point Within a Wetland?  
Hydric Soils Present? Yes  No  Yes  No   
Wetland Hydrology Present? Yes  No

### Remarks

*Wetland vegetation, hydrology, and soil criteria are met. Therefore, the sample plot is located in a wetland.*

Exhibit 16  
SSDP2016-00415  
000887

# Parametrix

Data Plot #: 24C-SP2  
Wetland: Upland near 24C

## WETLAND DETERMINATION (Modified from: 1987 ACOE Wetlands Delineation Manual)

Project/Site: ELST Re-delineation Date: 11/7/2007 Revisited 09-25-13  
Applicant/Owner: King County County: King  
Investigator: Chip Maney, Erik Christensen State: WA  
 1987 Method  1997 WA St. Method Community ID: Upland Forest  
Do Normal Circumstances exist on the site? Yes X No      Field Plot ID: 24C-SP2  
Is the site significantly disturbed (Atypical Situation)? Yes      No X  
Is the area a potential Problem Area? Yes      No X

**Remarks** (Explain sample location, disturbances, problem areas):

*This sample plot is located in a stand of alders approximately 5 feet north of flag W24C-11.*

### VEGETATION (✓ Dominant species are checked)

Plant Species	% Cover	Stratum	Indicator
✓ 1. <u>Rubus armeniacus</u>	<u>90</u>	<u>S</u>	<u>FACU</u>
✓ 2. <u>Alnus rubra</u>	<u>90</u>	<u>T</u>	<u>FAC</u>

Percent of **Dominant Species** that are OBL, FACW, or FAC (except FAC-). Include species noted (\*) as showing morphological adaptations to wetlands. "T" indicates trace. 50

**Remarks** (Describe disturbances, relevant local variations, seasonal effects, etc.):

*The percent of dominant species that are hydrophytic is not greater than 50 percent. Hydrophytic vegetation criterion is not satisfied.*

### HYDROLOGY

**Recorded Data** (Describe in Remarks):

     Stream, Lake, or Tide Gage  
     Aerial Photograph  
     Other  
X No Recorded Data Available

**Field Observations:**

Depth of Surface Water: none (in.)  
Depth to Free Water in Pit: none (in.)  
Depth to Saturated Soil: none (in.)

**Wetland Hydrology Indicators** (Describe in Remarks):

Primary Indicators:

     Inundated  
     Saturated in Upper 12 inches  
     Water Marks  
     Drift Lines  
     Sediment Deposits  
     Drainage Patterns in Wetlands

Secondary Indicators (2 or more required):

     Oxidized Rhizospheres in Upper 12 inches  
     Water-Stained Leaves  
     Local Soil Survey Data  
     Other (Explain in Remarks)

**Remarks** (As relevant, describe recent precipitation, hydrologic modifications, local variations, etc.):

*No primary or secondary indicators of hydrology are present. Wetland hydrology criterion is not satisfied.*

**Exhibit 16**  
**SSDP2016-00415**  
**000888**

# Parametrix

Data Plot #: 24C-SP2  
Wetland: Upland near 24C

Project/Site: ELST Re-delineation Date: 11/7/2007 Revisited 09-25-13

## SOIL

### Soil Survey Data:

Map Unit Name: Kitsap Silt Loam 2 to 8% slopes Drainage Class: Moderately well drained  
Field Observations Confirm Mapped Type?

Taxonomy (Subgroup): Dystric Xerochrepts Yes  No  NA

### Profile Description:

Depth (Inches)	Horizon Designation	Matrix Color (Munsell Moist)	Mottle Color (Munsell Moist)	Mottle Abundance/Contrast	Texture, Concretions, Rhizospheres, etc.
0-8	A	10YR 2/2	none	none	gravelly loam
8-16	B	10YR 5/2	7.5YR 5/6	few, fine, prominent	loam

### Hydric Soil Indicators:

- |  |  |
|--|--|
| <input type="checkbox"/> Histosol                              | <input type="checkbox"/> Listed on Hydric Soils List                 |
| <input type="checkbox"/> Histic Epipedon                       | <input type="checkbox"/> Fe/Mn Concretions                           |
| <input type="checkbox"/> Sulfidic Odor                         | <input type="checkbox"/> Organic Streaking in Sandy Soils            |
| <input type="checkbox"/> Aquic or Peraguc Moisture Regime      | <input checked="" type="checkbox"/> Mottles (Redoximorphic Features) |
| <input type="checkbox"/> Reducing Conditions                   | <input type="checkbox"/> Other (Explain in Remarks)                  |
| <input type="checkbox"/> Gleyed or Low-Chroma Colors           |  |
| <input type="checkbox"/> High Organic Content in Surface Layer |  |

Remarks (Describe soil disturbances, local variations, etc.):  
*Chroma 2 soil with redoximorphic features indicate hydric soils.*

## WETLAND DETERMINATION

Hydrophytic Vegetation Present? Yes  No  Is this Sampling Point Within a Wetland?  
Hydric Soils Present? Yes  No  Yes  No   
Wetland Hydrology Present? Yes  No

Remarks  
*Hydrophytic vegetation and wetland hydrology criteria are not satisfied. The sample plot is not located in a wetland.*

# WETLAND DETERMINATION DATA FORM – Western Mountains, Valleys, and Coast Region

Project Site: ELST - South Sammamish Segment City/County: Sammamish/King Sampling Date: 10-25-13  
 Applicant/Owner: King County State: WA Sampling Point: W24D-SP1 (rev)  
 Investigator(s): C. Worsley; M. Maynard Section, Township, Range: S31, T25N, R06E  
 Landform (hillslope, terrace, etc.): flat Local relief (concave, convex, none): none Slope (%): 0  
 Subregion (LRR): A Lat: \_\_\_\_\_ Long: \_\_\_\_\_ Datum: \_\_\_\_\_  
 Soil Map Unit Name: Kitsap silt loam, 2 to 8% slopes NWI classification: NA  
 Are climatic / hydrologic conditions on the site typical for this time of year? Yes  No  (If no, explain in Remarks.)  
 Are Vegetation , Soil , or Hydrology , significantly disturbed? Are "Normal Circumstances" present? Yes  No   
 Are Vegetation , Soil , or Hydrology , naturally problematic? (If needed, explain any answers in Remarks.)

### SUMMARY OF FINDINGS – Attach site map showing sampling point locations, transects, important features, etc.

Hydrophytic Vegetation Present?	Yes <input type="checkbox"/>	No <input checked="" type="checkbox"/>	<b>Is the Sampled Area within a Wetland?</b>	Yes <input type="checkbox"/>	No <input checked="" type="checkbox"/>
Hydric Soil Present?	Yes <input type="checkbox"/>	No <input checked="" type="checkbox"/>		Yes <input type="checkbox"/>	No <input checked="" type="checkbox"/>
Wetland Hydrology Present?	Yes <input type="checkbox"/>	No <input checked="" type="checkbox"/>		Yes <input type="checkbox"/>	No <input checked="" type="checkbox"/>
Remarks: Sample plot is located in what was previously identified as Wetland 24D. This area is no longer wetland as it does not meet the 3 wetland criteria. Sample plot is located 13 feet west of second chain link fence post north of split rail fence. Vegetation has been cleared mowed with some disturbance to soil.					

### VEGETATION – Use scientific names of plants

Tree Stratum (Plot size: <u>NA</u> )	Absolute % Cover	Dominant Species?	Indicator Status	Dominance Test Worksheet:																
1. _____	_____	_____	_____	Number of Dominant Species That Are OBL, FACW, or FAC: <u>1</u> (A)  Total Number of Dominant Species Across All Strata: <u>2</u> (B)  Percent of Dominant Species That Are OBL, FACW, or FAC: <u>50</u> (A/B)																
2. _____	_____	_____	_____																	
3. _____	_____	_____	_____																	
4. _____	_____	_____	_____																	
50% = _____, 20% = _____	_____	= Total Cover		<b>Prevalence Index worksheet:</b>  <table style="width: 100%; border: none;"> <tr> <td style="text-align: center;">Total % Cover of:</td> <td style="text-align: center;">Multiply by:</td> </tr> <tr> <td>OBL species _____</td> <td>x1 = _____</td> </tr> <tr> <td>FACW species _____</td> <td>x2 = _____</td> </tr> <tr> <td>FAC species _____</td> <td>x3 = _____</td> </tr> <tr> <td>FACU species _____</td> <td>x4 = _____</td> </tr> <tr> <td>UPL species _____</td> <td>x5 = _____</td> </tr> <tr> <td>Column Totals: _____ (A)</td> <td>_____ (B)</td> </tr> <tr> <td colspan="2" style="text-align: center;">Prevalence Index = B/A = _____</td> </tr> </table>	Total % Cover of:	Multiply by:	OBL species _____	x1 = _____	FACW species _____	x2 = _____	FAC species _____	x3 = _____	FACU species _____	x4 = _____	UPL species _____	x5 = _____	Column Totals: _____ (A)	_____ (B)	Prevalence Index = B/A = _____	
Total % Cover of:	Multiply by:																			
OBL species _____	x1 = _____																			
FACW species _____	x2 = _____																			
FAC species _____	x3 = _____																			
FACU species _____	x4 = _____																			
UPL species _____	x5 = _____																			
Column Totals: _____ (A)	_____ (B)																			
Prevalence Index = B/A = _____																				
<b>Sapling/Shrub Stratum (Plot size: <u>NA</u>)</b>																				
1. _____	_____	_____	_____																	
2. _____	_____	_____	_____																	
3. _____	_____	_____	_____																	
4. _____	_____	_____	_____																	
5. _____	_____	_____	_____																	
50% = _____, 20% = _____	_____	= Total Cover																		
<b>Herb Stratum (Plot size: <u>3 feet</u>)</b>																				
1. <u><i>Phalaris arundinacea</i></u>	<u>50</u>	<u>yes</u>	<u>FACW</u>																	
2. <u><i>Convolvulus arvensis</i></u>	<u>10</u>	<u>no</u>	<u>NL (UPL)</u>																	
3. <u><i>Epilobium ciliatum</i></u>	<u>2</u>	<u>no</u>	<u>FACW</u>																	
4. <u><i>Cardamine oligosperma</i></u>	<u>2</u>	<u>no</u>	<u>FAC</u>																	
5. _____	_____	_____	_____																	
6. _____	_____	_____	_____																	
7. _____	_____	_____	_____																	
8. _____	_____	_____	_____																	
9. _____	_____	_____	_____																	
10. _____	_____	_____	_____																	
11. _____	_____	_____	_____																	
50% = <u>32</u> , 20% = <u>13</u>	<u>64</u>	= Total Cover																		
<b>Woody Vine Stratum (Plot size: <u>10 feet</u>)</b>																				
1. <u><i>Rubus armeniacus</i></u>	<u>35</u>	<u>yes</u>	<u>FACU</u>																	
2. _____	_____	_____	_____																	
50% = _____, 20% = _____	<u>35</u>	= Total Cover																		
% Bare Ground in Herb Stratum <u>20</u>																				
<b>Hydrophytic Vegetation Indicators:</b> <input type="checkbox"/> 1 – Rapid Test for Hydrophytic Vegetation <input type="checkbox"/> 2 - Dominance Test is >50% <input type="checkbox"/> 3 - Prevalence Index is ≤3.0' <input type="checkbox"/> 4 - Morphological Adaptations <sup>1</sup> (Provide supporting data in Remarks or on a separate sheet) <input type="checkbox"/> 5 - Wetland Non-Vascular Plants <sup>1</sup> <input type="checkbox"/> Problematic Hydrophytic Vegetation <sup>1</sup> (Explain)																				
<sup>1</sup> Indicators of hydric soil and wetland hydrology must be present, unless disturbed or problematic.																				
<b>Hydrophytic Vegetation Present?</b> Yes <input type="checkbox"/> No <input checked="" type="checkbox"/>																				

Remarks: Species with less than 5% cover are not considered dominant. Vegetation has been cleared/mowed.

**SOIL**

Profile Description: (Describe to the depth needed to document the indicator or confirm the absence of indicators.)								
Depth (inches)	Matrix		Redox Features				Texture	Remarks
	Color (moist)	%	Color (moist)	%	Type <sup>1</sup>	Loc <sup>2</sup>		
0-8	10YR 3/1	100	-	-	-	-	gr. sa. loam	
8-18	2.5Y 3/1	100	-	-	-	-	gr. sa. loam	w. many cobbles and wood debris

<sup>1</sup>Type: C= Concentration, D=Depletion, RM=Reduced Matrix, CS=Covered or Coated Sand Grains.      <sup>2</sup>Location: PL=Pore Lining, M=Matrix

<b>Hydric Soil Indicators: (Applicable to all LRRs, unless otherwise noted.)</b>			<b>Indicators for Problematic Hydric Soils<sup>3</sup>:</b>		
<input type="checkbox"/> Histosol (A1)	<input type="checkbox"/> Sandy Redox (S5)	<input type="checkbox"/> 2 cm Muck (A10)			
<input type="checkbox"/> Histic Epipedon (A2)	<input type="checkbox"/> Stripped Matrix (S6)	<input type="checkbox"/> Red Parent Material (TF2)			
<input type="checkbox"/> Black Histic (A3)	<input type="checkbox"/> Loamy Mucky Mineral (F1) <b>(except MLRA 1)</b>	<input type="checkbox"/> Very Shallow Dark Surface (TF12)			
<input type="checkbox"/> Hydrogen Sulfide (A4)	<input type="checkbox"/> Loamy Gleyed Matrix (F2)	<input type="checkbox"/> Other (Explain in Remarks)			
<input type="checkbox"/> Depleted Below Dark Surface (A11)	<input type="checkbox"/> Depleted Matrix (F3)				
<input type="checkbox"/> Thick Dark Surface (A12)	<input type="checkbox"/> Redox Dark Surface (F6)				
<input type="checkbox"/> Sandy Mucky Mineral (S1)	<input type="checkbox"/> Depleted Dark Surface (F7)				
<input type="checkbox"/> Sandy Gleyed Matrix (S4)	<input type="checkbox"/> Redox Depressions (F8)				

<sup>3</sup>Indicators of hydrophytic vegetation and wetland hydrology must be present, unless disturbed or problematic.

<b>Restrictive Layer (if present):</b>	<b>Hydric Soils Present?</b>	Yes	<input type="checkbox"/>	No	<input checked="" type="checkbox"/>
Type: _____					
Depth (inches): _____					

Remarks: Soil disturbance and vegetation mowing/clearing on site.

**HYDROLOGY**

<b>Wetland Hydrology Indicators:</b>			
Primary Indicators (minimum of one required; check all that apply)		Secondary Indicators (2 or more required)	
<input type="checkbox"/> Surface Water (A1)	<input type="checkbox"/> Water-Stained Leaves (B9)	<input type="checkbox"/> Water-Stained Leaves (B9)	
<input type="checkbox"/> High Water Table (A2)	<b>(except MLRA 1, 2, 4A, and 4B)</b>	<b>(MLRA 1, 2, 4A, and 4B)</b>	
<input type="checkbox"/> Saturation (A3)	<input type="checkbox"/> Salt Crust (B11)	<input type="checkbox"/> Drainage Patterns (B10)	
<input type="checkbox"/> Water Marks (B1)	<input type="checkbox"/> Aquatic Invertebrates (B13)	<input type="checkbox"/> Dry-Season Water Table (C2)	
<input type="checkbox"/> Sediment Deposits (B2)	<input type="checkbox"/> Hydrogen Sulfide Odor (C1)	<input type="checkbox"/> Saturation Visible on Aerial Imagery (C9)	
<input type="checkbox"/> Drift Deposits (B3)	<input type="checkbox"/> Oxidized Rhizospheres along Living Roots (C3)	<input type="checkbox"/> Geomorphic Position (D2)	
<input type="checkbox"/> Algal Mat or Crust (B4)	<input type="checkbox"/> Presence of Reduced Iron (C4)	<input type="checkbox"/> Shallow Aquitard (D3)	
<input type="checkbox"/> Iron Deposits (B5)	<input type="checkbox"/> Recent Iron Reduction in Tilled Soils (C6)	<input type="checkbox"/> FAC-Neutral Test (D5)	
<input type="checkbox"/> Surface Soil Cracks (B6)	<input type="checkbox"/> Stunted or Stresses Plants (D1) <b>(LRR A)</b>	<input type="checkbox"/> Raised Ant Mounds (D6) <b>(LRR A)</b>	
<input type="checkbox"/> Inundation Visible on Aerial Imagery (B7)	<input type="checkbox"/> Other (Explain in Remarks)	<input type="checkbox"/> Frost-Heave Hummocks (D7)	
<input type="checkbox"/> Sparsely Vegetated Concave Surface (B8)			

<b>Field Observations:</b>			
Surface Water Present?	Yes <input type="checkbox"/> No <input checked="" type="checkbox"/>	Depth (inches): _____	<b>Wetland Hydrology Present?</b> Yes <input type="checkbox"/> No <input checked="" type="checkbox"/>
Water Table Present?	Yes <input type="checkbox"/> No <input checked="" type="checkbox"/>	Depth (inches): _____	
Saturation Present? (includes capillary fringe)	Yes <input type="checkbox"/> No <input checked="" type="checkbox"/>	Depth (inches): _____	
Describe Recorded Data (stream gauge, monitoring well, aerial photos, previous inspections), if available:			

Remarks:

**Exhibit 16**  
**SSDP2016-00415**



Data Plot #: 25A-SP1  
Wetland: 25A

## WETLAND DETERMINATION (Modified from: 1987 ACOE Wetlands Delineation Manual)

Project/Site: ELST Re-delineation Date: 11/8/2007 Revisited 09-25-13  
Applicant/Owner: King County County: King  
Investigator: Chip Maney, Erik Christensen State: WA  
 1987 Method  1997 WA St. Method Community ID: PFO/PSS  
Do Normal Circumstances exist on the site? Yes X No \_\_\_\_\_ Field Plot ID: 25A-SP1  
Is the site significantly disturbed (Atypical Situation)? Yes \_\_\_\_\_ No X  
Is the area a potential Problem Area? Yes \_\_\_\_\_ No X

**Remarks** (Explain sample location, disturbances, problem areas):

*This sample plot is located between flags W25A-3 and W25-4 on the boundary between grasses and shrubs.*

### VEGETATION (✓ Dominant species are checked)

Plant Species	% Cover	Stratum	Indicator
✓ 1. <u>Phalaris arundinacea</u>	<u>75</u>	<u>H</u>	<u>FACW</u>
✓ 2. <u>Cornus sericea</u>	<u>20</u>	<u>S</u>	<u>FACW</u>
✓ 3. <u>Lonicera involucrata</u>	<u>20</u>	<u>S</u>	<u>FAC</u>
4. <u>Rubus armeniacus</u>	<u>2</u>	<u>S</u>	<u>FACU</u>
✓ 5. <u>Salix lucida</u>	<u>50</u>	<u>S</u>	<u>FACW+</u>

Percent of **Dominant Species** that are OBL, FACW, or FAC (except FAC-). Include species noted (\*) as showing morphological adaptations to wetlands. "T" indicates trace. 100

**Remarks** (Describe disturbances, relevant local variations, seasonal effects, etc.):

*The percent of dominant species that are hydrophytic is greater than 50 percent. Hydrophytic vegetation criterion is satisfied.*

### HYDROLOGY

**Recorded Data** (Describe in Remarks):

\_\_\_\_\_ Stream, Lake, or Tide Gage  
\_\_\_\_\_ Aerial Photograph  
\_\_\_\_\_ Other  
X No Recorded Data Available

**Field Observations:**

Depth of Surface Water: none (in.)  
Depth to Free Water in Pit: surface (in.)  
Depth to Saturated Soil: surface (in.)

**Wetland Hydrology Indicators** (Describe in Remarks):

Primary Indicators:

\_\_\_\_\_ Inundated  
X Saturated in Upper 12 inches  
\_\_\_\_\_ Water Marks  
\_\_\_\_\_ Drift Lines  
\_\_\_\_\_ Sediment Deposits  
\_\_\_\_\_ Drainage Patterns in Wetlands

Secondary Indicators (2 or more required):

\_\_\_\_\_ Oxidized Rhizospheres in Upper 12 inches  
\_\_\_\_\_ Water-Stained Leaves  
\_\_\_\_\_ Local Soil Survey Data  
\_\_\_\_\_ Other (Explain in Remarks)

**Remarks** (As relevant, describe recent precipitation, hydrologic modifications, local variations, etc.):

*Saturation in the upper 12 inches satisfies wetland hydrology criterion.*

# Parametrix

Data Plot #: 25A-SP1  
Wetland: 25A

Project/Site: ELST Re-delineation Date: 11/8/2007 Revised 09-25-13

## SOIL

### Soil Survey Data:

Map Unit Name: Norma Sandy Loam Drainage Class: Poorly drained  
Field Observations Confirm Mapped Type?  
Taxonomy (Subgroup): Fluventic Humaquepts Yes  No  NA

### Profile Description:

Depth (Inches)	Horizon Designation	Matrix Color (Munsell Moist)	Mottle Color (Munsell Moist)	Mottle Abundance/Contrast	Texture, Concretions, Rhizospheres, etc.
0-8	A	10YR 3/1	none	none	silt loam
8-18	B	10YR 2/1	none	none	loam

### Hydric Soil Indicators:

- |   |   |
|---|---|
| <input type="checkbox"/> Histosol                               | <input type="checkbox"/> Listed on Hydric Soils List      |
| <input type="checkbox"/> Histic Epipedon                        | <input type="checkbox"/> Fe/Mn Concretions                |
| <input type="checkbox"/> Sulfidic Odor                          | <input type="checkbox"/> Organic Streaking in Sandy Soils |
| <input type="checkbox"/> Aquic or Peraguc Moisture Regime       | <input type="checkbox"/> Mottles (Redoximorphic Features) |
| <input type="checkbox"/> Reducing Conditions                    | <input type="checkbox"/> Other (Explain in Remarks)       |
| <input checked="" type="checkbox"/> Gleyed or Low-Chroma Colors |   |
| <input type="checkbox"/> High Organic Content in Surface Layer  |   |

Remarks (Describe soil disturbances, local variations, etc.):  
*Chroma 1 soil indicate hydric soils.*

## WETLAND DETERMINATION

Hydrophytic Vegetation Present? Yes  No  Is this Sampling Point Within a Wetland?  
Hydric Soils Present? Yes  No  Yes  No   
Wetland Hydrology Present? Yes  No

Remarks  
*Wetland vegetation, hydrology, and soil criteria are met. Therefore, the sample plot is located in a wetland.*

# Parametrix

Data Plot #: 25A-SP2  
Wetland: Upland near 25A

## WETLAND DETERMINATION (Modified from: 1987 ACOE Wetlands Delineation Manual)

Project/Site: ELST Re-delineation Date: 11/8/2007 Revisited 09-25-13  
Applicant/Owner: King County County: King  
Investigator: Chip Maney State: WA  
 1987 Method  1997 WA St. Method Community ID: Upland Shrub  
Do Normal Circumstances exist on the site? Yes X No \_\_\_\_\_ Field Plot ID: 25A-SP2  
Is the site significantly disturbed (Atypical Situation)? Yes \_\_\_\_\_ No X  
Is the area a potential Problem Area? Yes \_\_\_\_\_ No X

**Remarks** (Explain sample location, disturbances, problem areas):  
*This sample plot is located 20 feet north of flag W25A-9.*

### VEGETATION (✓ Dominant species are checked)

Plant Species	% Cover	Stratum	Indicator
✓ 1. <u>Agrostis stolonifera</u>	<u>20</u>	<u>H</u>	<u>FAC*</u>
2. <u>Geranium molle</u>	<u>trace</u>	<u>H</u>	<u>NL</u>
3. <u>Hypochaeris radicata</u>	<u>trace</u>	<u>H</u>	<u>FACU</u>
✓ 4. <u>Poa spp.</u>	<u>50</u>	<u>H</u>	
5. <u>Taraxacum officinale</u>	<u>trace</u>	<u>H</u>	<u>FACU</u>
6. <u>Trifolium repens</u>	<u>trace</u>	<u>H</u>	<u>FAC*</u>
✓ 7. <u>Rubus armeniacus</u>	<u>50</u>	<u>S</u>	<u>FACU</u>

**09-25-13 Observations**  
Rubus armeniacus 50%

Percent of **Dominant Species** that are OBL, FACW, or FAC (except FAC-). Include species noted (\*) as showing morphological adaptations to wetlands. "T" indicates trace. 50

**09-25-13 Observations** - Vegetation used to be lawn. Area is now bark with few landscaping plants. Rubus armeniacus is still present.

**Remarks** (Describe disturbances, relevant local variations, seasonal effects, etc.):  
*The percent of dominant species that are hydrophytic is not greater than 50 percent. Hydrophytic vegetation criterion is not satisfied.*

### HYDROLOGY

**Recorded Data** (Describe in Remarks):  
\_\_\_\_\_  
Stream, Lake, or Tide Gage  
\_\_\_\_\_  
Aerial Photograph  
\_\_\_\_\_  
Other  
X No Recorded Data Available

**Wetland Hydrology Indicators** (Describe in Remarks):  
Primary Indicators:

\_\_\_\_\_  
Inundated  
\_\_\_\_\_  
Saturated in Upper 12 inches  
\_\_\_\_\_  
Water Marks  
\_\_\_\_\_  
Drift Lines  
\_\_\_\_\_  
Sediment Deposits  
\_\_\_\_\_  
Drainage Patterns in Wetlands

**Field Observations:**

Depth of Surface Water: none (in.)  
Depth to Free Water in Pit: none (in.)  
Depth to Saturated Soil: none (in.)

Secondary Indicators (2 or more required):  
\_\_\_\_\_  
Oxidized Rhizospheres in Upper 12 inches  
\_\_\_\_\_  
Water-Stained Leaves  
\_\_\_\_\_  
Local Soil Survey Data  
\_\_\_\_\_  
Other (Explain in Remarks)

**Remarks** (As relevant, describe recent precipitation, hydrologic modifications, local variations, etc.):  
*No primary or secondary indicators of hydrology are present. Wetland hydrology criterion is not satisfied.*

# Parametrix

Data Plot #: 25A-SP2  
Wetland: Upland near 25A

Project/Site: ELST Re-delineation Date: 11/8/2007 Revisited 09-25-13

## SOIL

### Soil Survey Data:

Map Unit Name: Mixed Alluvial Land Drainage Class: Well drained to very poorly drained  
Field Observations Confirm Mapped Type?

Taxonomy (Subgroup): N/A Yes  No  NA

### Profile Description:

Depth (Inches)	Horizon Designation	Matrix Color (Munsell Moist)	Mottle Color (Munsell Moist)	Mottle Abundance/Contrast	Texture, Concretions, Rhizospheres, etc.
0-6	A	10YR 3/2	none	none	loam
6-16	B	10YR 3/2	10YR 5/6	few, fine, prominent	gravelly loam

### Hydric Soil Indicators:

- |   |  |
|---|--|
| <input type="checkbox"/> Histosol                               | <input type="checkbox"/> Listed on Hydric Soils List                 |
| <input type="checkbox"/> Histic Epipedon                        | <input type="checkbox"/> Fe/Mn Concretions                           |
| <input type="checkbox"/> Sulfidic Odor                          | <input type="checkbox"/> Organic Streaking in Sandy Soils            |
| <input type="checkbox"/> Aquic or Peraguc Moisture Regime       | <input checked="" type="checkbox"/> Mottles (Redoximorphic Features) |
| <input type="checkbox"/> Reducing Conditions                    | <input type="checkbox"/> Other (Explain in Remarks)                  |
| <input checked="" type="checkbox"/> Gleyed or Low-Chroma Colors |  |
| <input type="checkbox"/> High Organic Content in Surface Layer  |  |

Remarks (Describe soil disturbances, local variations, etc.):  
*Chroma 2 soil with redoximorphic features indicate hydric soils.*

## WETLAND DETERMINATION

Hydrophytic Vegetation Present? Yes  No  Is this Sampling Point Within a Wetland?  
Hydric Soils Present? Yes  No  Yes  No   
Wetland Hydrology Present? Yes  No

Remarks  
*Wetland vegetation, and hydrology criteria are not met. Therefore, the sample plot is not located in a wetland.*

Data Plot #: 25B-SP1  
Wetland: 25B

## WETLAND DETERMINATION (Modified from: 1987 ACOE Wetlands Delineation Manual)

Project/Site: ELST Re-delineation Date: 11/8/2007 Revised 09-25-13  
Applicant/Owner: King County County: King  
Investigator: Matt Maynard State: WA  
 1987 Method  1997 WA St. Method Community ID: PEM  
Do Normal Circumstances exist on the site? Yes X No \_\_\_\_\_ Field Plot ID: 25B-SP1  
Is the site significantly disturbed (Atypical Situation)? Yes \_\_\_\_\_ No X  
Is the area a potential Problem Area? Yes \_\_\_\_\_ No X

**Remarks** (Explain sample location, disturbances, problem areas):

*This sample plot is located approximately 10 feet north of flag 1 and 15 feet east/northeast of flag 3.*

### VEGETATION (✓ Dominant species are checked)

Plant Species	% Cover	Stratum	Indicator
✓ 1. <u>Phalaris arundinacea</u>	<u>100</u>	<u>Herb</u>	<u>FACW</u>
2. <u>Lonicera involucrata</u>	<u>trace</u>	<u>Shrub</u>	<u>FAC</u>
3. <u>Rosa nutkana</u>	<u>trace</u>	<u>Shrub</u>	<u>FAC</u>
4. <u>Alnus rubra</u>	<u>15</u>	<u>Tree</u>	<u>FAC</u>

Percent of **Dominant Species** that are OBL, FACW, or FAC (except FAC-). Include species noted (\*) as showing morphological adaptations to wetlands. "T" indicates trace. 100

**Remarks** (Describe disturbances, relevant local variations, seasonal effects, etc.):

*The percent of dominant species that are hydrophytic is greater than 50 percent. Hydrophytic vegetation criterion is satisfied.*

### HYDROLOGY

**Recorded Data** (Describe in Remarks):

\_\_\_\_\_ Stream, Lake, or Tide Gage  
\_\_\_\_\_ Aerial Photograph  
\_\_\_\_\_ Other  
X No Recorded Data Available

**Field Observations:**

Depth of Surface Water: none (in.)  
Depth to Free Water in Pit: none (in.)  
Depth to Saturated Soil: 4 (in.)

**Wetland Hydrology Indicators** (Describe in Remarks):

Primary Indicators:

\_\_\_\_\_ Inundated  
X Saturated in Upper 12 inches  
\_\_\_\_\_ Water Marks  
\_\_\_\_\_ Drift Lines  
\_\_\_\_\_ Sediment Deposits  
\_\_\_\_\_ Drainage Patterns in Wetlands

Secondary Indicators (2 or more required):

\_\_\_\_\_ Oxidized Rhizospheres in Upper 12 inches  
\_\_\_\_\_ Water-Stained Leaves  
\_\_\_\_\_ Local Soil Survey Data  
\_\_\_\_\_ Other (Explain in Remarks)

**Remarks** (As relevant, describe recent precipitation, hydrologic modifications, local variations, etc.):

*Site visits were conducted in January of 2008 to confirm hydrology. Saturation in the upper 12 inches satisfies wetland hydrology criterion.*

**09-25-13 Observations** - No saturated soils to at least 18 inches below the surface.

# Parametrix

Data Plot #: 25B-SP1  
Wetland: 25B

Project/Site: ELST Re-delineation Date: 11/8/2007 Revised 09-25-13

## SOIL

### Soil Survey Data:

Map Unit Name: Mixed Alluvial Land Drainage Class: Well drained to very poorly drained  
Field Observations Confirm Mapped Type?

Taxonomy (Subgroup): N/A Yes  No  NA

### Profile Description:

Depth (Inches)	Horizon Designation	Matrix Color (Munsell Moist)	Mottle Color (Munsell Moist)	Mottle Abundance/Contrast	Texture, Concretions, Rhizospheres, etc.
0-6	A	10YR 3/2	none	none	gravelly silt loam
6-17	B	10YR 3/1	10YR 3/3	few, fine, faint	silt loam

### Hydric Soil Indicators:

- |   |  |
|---|--|
| <input type="checkbox"/> Histosol                               | <input type="checkbox"/> Listed on Hydric Soils List                 |
| <input type="checkbox"/> Histic Epipedon                        | <input type="checkbox"/> Fe/Mn Concretions                           |
| <input type="checkbox"/> Sulfidic Odor                          | <input type="checkbox"/> Organic Streaking in Sandy Soils            |
| <input type="checkbox"/> Aquic or Peraguc Moisture Regime       | <input checked="" type="checkbox"/> Mottles (Redoximorphic Features) |
| <input type="checkbox"/> Reducing Conditions                    | <input type="checkbox"/> Other (Explain in Remarks)                  |
| <input checked="" type="checkbox"/> Gleyed or Low-Chroma Colors |  |
| <input type="checkbox"/> High Organic Content in Surface Layer  |  |

Remarks (Describe soil disturbances, local variations, etc.):  
*Chroma 1 soil and redoximorphic features indicate hydric soils.*

## WETLAND DETERMINATION

Hydrophytic Vegetation Present? Yes  No  Is this Sampling Point Within a Wetland?  
Hydric Soils Present? Yes  No  Yes  No   
Wetland Hydrology Present? Yes  No

Remarks  
*Wetland vegetation, hydrology, and soil criteria are met. Therefore, the sample plot is located in a wetland.*

Data Plot #: 25B-SP2  
 Wetland: Upland near 25B

## WETLAND DETERMINATION (Modified from: 1987 ACOE Wetlands Delineation Manual)

Project/Site: ELST Re-delineation Date: 11/8/2007 Revised 09-25-13  
 Applicant/Owner: King County County: King  
 Investigator: Matt Maynard State: WA  
 1987 Method  1997 WA St. Method Community ID: Upland Shrub  
 Do Normal Circumstances exist on the site? Yes X No \_\_\_\_\_ Field Plot ID: 25B-SP2  
 Is the site significantly disturbed (Atypical Situation)? Yes \_\_\_\_\_ No X  
 Is the area a potential Problem Area? Yes \_\_\_\_\_ No X

**Remarks** (Explain sample location, disturbances, problem areas):  
*This sample plot is located 20 feet south of flag 1 under a canopy of alders, but southwest of tree trunk.*

### VEGETATION (✓ Dominant species are checked)

	Plant Species	% Cover	Stratum	Indicator
1.	<u>Phalaris arundinacea</u>	<u>15</u>	<u>Herb</u>	<u>FACW</u>
✓ 2.	<u>Rubus armeniacus</u>	<u>75</u>	<u>Shrub</u>	<u>FACU</u>
✓ 3.	<u>Alnus rubra</u>	<u>40</u>	<u>Tree</u>	<u>FAC</u>

Percent of **Dominant Species** that are OBL, FACW, or FAC (except FAC-). Include species noted (\*) as showing morphological adaptations to wetlands. "T" indicates trace. 50

**Remarks** (Describe disturbances, relevant local variations, seasonal effects, etc.):  
*The percent of dominant species that are hydrophytic is not greater than 50 percent. Hydrophytic vegetation criterion is not satisfied.*

### HYDROLOGY

**Recorded Data** (Describe in Remarks):

\_\_\_\_\_ Stream, Lake, or Tide Gage  
 \_\_\_\_\_ Aerial Photograph  
 \_\_\_\_\_ Other  
X No Recorded Data Available

**Field Observations:**

Depth of Surface Water: none (in.)  
 Depth to Free Water in Pit: none (in.)  
 Depth to Saturated Soil: none (in.)

**Wetland Hydrology Indicators** (Describe in Remarks):

Primary Indicators:  
 \_\_\_\_\_ Inundated  
 \_\_\_\_\_ Saturated in Upper 12 inches  
 \_\_\_\_\_ Water Marks  
 \_\_\_\_\_ Drift Lines  
 \_\_\_\_\_ Sediment Deposits  
 \_\_\_\_\_ Drainage Patterns in Wetlands

Secondary Indicators (2 or more required):  
 \_\_\_\_\_ Oxidized Rhizospheres in Upper 12 inches  
 \_\_\_\_\_ Water-Stained Leaves  
 \_\_\_\_\_ Local Soil Survey Data  
 \_\_\_\_\_ Other (Explain in Remarks)

**Remarks** (As relevant, describe recent precipitation, hydrologic modifications, local variations, etc.):  
*No primary or secondary indicators of hydrology are present. Wetland hydrology criterion is not satisfied.*

# Parametrix

Data Plot #: 25B-SP2  
Wetland: Upland near 25B

Project/Site: ELST Re-delineation Date: 11/8/2007 Revisited 09-25-13

## SOIL

### Soil Survey Data:

Map Unit Name: Mixed Alluvial Land Drainage Class: Well drained to very poorly drained  
Field Observations Confirm Mapped Type?

Taxonomy (Subgroup): N/A Yes  No  NA

### Profile Description:

Depth (Inches)	Horizon Designation	Matrix Color (Munsell Moist)	Mottle Color (Munsell Moist)	Mottle Abundance/Contrast	Texture, Concretions, Rhizospheres, etc.
0-16	A	10YR 3/2	none	none	gravelly loam
6-18+	B	10YR 3/2	none	none	gravelly loam

### Hydric Soil Indicators:

- |  |   |
|--|---|
| <input type="checkbox"/> Histosol                              | <input type="checkbox"/> Listed on Hydric Soils List      |
| <input type="checkbox"/> Histic Epipedon                       | <input type="checkbox"/> Fe/Mn Concretions                |
| <input type="checkbox"/> Sulfidic Odor                         | <input type="checkbox"/> Organic Streaking in Sandy Soils |
| <input type="checkbox"/> Aquic or Peragucic Moisture Regime    | <input type="checkbox"/> Mottles (Redoximorphic Features) |
| <input type="checkbox"/> Reducing Conditions                   | <input type="checkbox"/> Other (Explain in Remarks)       |
| <input type="checkbox"/> Gleyed or Low-Chroma Colors           |   |
| <input type="checkbox"/> High Organic Content in Surface Layer |   |

**Remarks** (Describe soil disturbances, local variations, etc.):  
*Silt inclusions with a color of 10YR 5/1 and 10YR 4/6 were present from 6-18+ inches in depth. Cobbles were also found throughout the profile. No hydric soil indicators are present. Hydric soil criterion is not satisfied.*

## WETLAND DETERMINATION

Hydrophytic Vegetation Present?	Yes <input type="checkbox"/> No <input checked="" type="checkbox"/>	Is this Sampling Point Within a Wetland? Yes <input type="checkbox"/> No <input checked="" type="checkbox"/>
Hydric Soils Present?	Yes <input type="checkbox"/> No <input checked="" type="checkbox"/>	
Wetland Hydrology Present?	Yes <input type="checkbox"/> No <input checked="" type="checkbox"/>	

**Remarks**  
*Hydrophytic vegetation, hydric soil, and wetland hydrology criteria are not satisfied. Therefore, the sample plot is not located in a wetland.*



Data Plot #: 25B-SP3  
Wetland: 25B

## WETLAND DETERMINATION (Modified from: 1987 ACOE Wetlands Delineation Manual)

Project/Site: ELST Re-delineation Date: 11/8/2007 Revisited 09-25-13  
Applicant/Owner: King County County: King  
Investigator: Matt Maynard State: WA  
 1987 Method  1997 WA St. Method Community ID: PFO  
Do Normal Circumstances exist on the site? Yes X No \_\_\_\_\_ Field Plot ID: 25B-SP3  
Is the site significantly disturbed (Atypical Situation)? Yes \_\_\_\_\_ No X  
Is the area a potential Problem Area? Yes \_\_\_\_\_ No X

**Remarks** (Explain sample location, disturbances, problem areas):  
*This sample plot is located approximately 12 feet east of flag 25B-7.*

### VEGETATION (✓ Dominant species are checked)

Plant Species	% Cover	Stratum	Indicator
✓ 1. <u>Carex obnupta</u>	<u>50</u>	<u>Herb</u>	<u>OBL</u>
✓ 2. <u>Cornus sericea</u>	<u>75</u>	<u>Shrub</u>	<u>FACW</u>
3. <u>Rosa pisocarpa</u>	<u>trace</u>	<u>Shrub</u>	<u>FAC</u>
✓ 4. <u>Fraxinus latifolia</u>	<u>60</u>	<u>Tree</u>	<u>FACW</u>

Percent of **Dominant Species** that are OBL, FACW, or FAC (except FAC-). Include species noted (\*) as showing morphological adaptations to wetlands. "T" indicates trace. 100

**Remarks** (Describe disturbances, relevant local variations, seasonal effects, etc.):  
*The percent of dominant species that are hydrophytic is greater than 50 percent. Hydrophytic vegetation criterion is satisfied.*

### HYDROLOGY

**Recorded Data** (Describe in Remarks):

\_\_\_\_\_ Stream, Lake, or Tide Gage  
\_\_\_\_\_ Aerial Photograph  
\_\_\_\_\_ Other  
X No Recorded Data Available

**Field Observations:**

Depth of Surface Water: none (in.)  
Depth to Free Water in Pit: 18 (in.)  
Depth to Saturated Soil: 12 (in.)

**Wetland Hydrology Indicators** (Describe in Remarks):

Primary Indicators:

\_\_\_\_\_ Inundated  
X Saturated in Upper 12 inches  
X Water Marks  
\_\_\_\_\_ Drift Lines  
\_\_\_\_\_ Sediment Deposits  
\_\_\_\_\_ Drainage Patterns in Wetlands

Secondary Indicators (2 or more required):

\_\_\_\_\_ Oxidized Rhizospheres in Upper 12 inches  
\_\_\_\_\_ Water-Stained Leaves  
\_\_\_\_\_ Local Soil Survey Data  
\_\_\_\_\_ Other (Explain in Remarks)

**Remarks** (As relevant, describe recent precipitation, hydrologic modifications, local variations, etc.):  
*Watermarks indicate inundation at approximately 8 inches. Saturation at 12 inches and watermarks at 8 inches indicated wetland hydrology is present. Wetland hydrology criterion is satisfied.*

**09-25-13 Observations** - No saturated soils to at least 18 inches below the surface.

# Parametrix

Data Plot #: 25B-SP3  
Wetland: 25B

Project/Site: ELST Re-delineation Date: 11/8/2007 Revisited 09-25-13

## SOIL

### Soil Survey Data:

Map Unit Name: Mixed Alluvial Land Drainage Class: Well drained to very poorly drained  
Field Observations Confirm Mapped Type?

Taxonomy (Subgroup): N/A Yes  No  NA

### Profile Description:

Depth (Inches)	Horizon Designation	Matrix Color (Munsell Moist)	Mottle Color (Munsell Moist)	Mottle Abundance/Contrast	Texture, Concretions, Rhizospheres, etc.
0-7	A	10YR 2/1	none	none	loam
7-17	B	2.5Y 4/1	7.5YR 4/6	common, medium, prominent	clay loam
17-20	C	10YR 5/1	7.5YR 4/6	common, medium, prominent	clay loam

### Hydric Soil Indicators:

- |   |  |
|---|--|
| <input type="checkbox"/> Histosol                               | <input type="checkbox"/> Listed on Hydric Soils List                 |
| <input type="checkbox"/> Histic Epipedon                        | <input type="checkbox"/> Fe/Mn Concretions                           |
| <input type="checkbox"/> Sulfidic Odor                          | <input type="checkbox"/> Organic Streaking in Sandy Soils            |
| <input type="checkbox"/> Aquic or Peraguic Moisture Regime      | <input checked="" type="checkbox"/> Mottles (Redoximorphic Features) |
| <input type="checkbox"/> Reducing Conditions                    | <input type="checkbox"/> Other (Explain in Remarks)                  |
| <input checked="" type="checkbox"/> Gleyed or Low-Chroma Colors |  |
| <input type="checkbox"/> High Organic Content in Surface Layer  |  |

Remarks (Describe soil disturbances, local variations, etc.):  
*Chroma 1 soil and redoximorphic features indicate hydric soils.*

## WETLAND DETERMINATION

Hydrophytic Vegetation Present? Yes  No  Is this Sampling Point Within a Wetland?  
Hydric Soils Present? Yes  No  Yes  No   
Wetland Hydrology Present? Yes  No

### Remarks

*Wetland vegetation, hydrology, and soil criteria are met. Therefore, the sample plot is located in a wetland.*

Exhibit 16  
SSDP2016-00415  
000901

Data Plot #: 25C-SP1  
 Wetland: 25C

## WETLAND DETERMINATION (Modified from: 1987 ACOE Wetlands Delineation Manual)

Project/Site: ELST Re-delineation Date: 11/8/2007 Revisited 09-25-13  
 Applicant/Owner: King County County: King  
 Investigator: Chip Maney State: WA

1987 Method  1997 WA St. Method Community ID: PFO  
 Do Normal Circumstances exist on the site? Yes X No \_\_\_\_\_ Field Plot ID: 25C-SP1  
 Is the site significantly disturbed (Atypical Situation)? Yes \_\_\_\_\_ No X  
 Is the area a potential Problem Area? Yes \_\_\_\_\_ No X

**Remarks** (Explain sample location, disturbances, problem areas):  
*This sample plot is located 25 feet west of flay W25C-3. No upland plot was sample for this wetland.*

### VEGETATION (✓ Dominant species are checked)

Plant Species	% Cover	Stratum	Indicator
1. <u>Equisetum telmateia</u>	<u>5</u>	<u>Herb</u>	<u>FACW</u>
2. <u>Phalaris arundinacea</u>	<u>2</u>	<u>Herb</u>	<u>FACW</u>
✓ 3. <u>Cornus sericea</u>	<u>45</u>	<u>Shrub</u>	<u>FACW</u>
4. <u>Rosa pisocarpa</u>	<u>10</u>	<u>Shrub</u>	<u>FAC</u>
✓ 5. <u>Rubus armeniacus</u>	<u>20</u>	<u>Shrub</u>	<u>FACU</u>
✓ 6. <u>Alnus rubra</u>	<u>75</u>	<u>Tree</u>	<u>FAC</u>

Percent of **Dominant Species** that are OBL, FACW, or FAC (except FAC-). Include species noted (\*) as showing morphological adaptations to wetlands. "T" indicates trace. 67

**Remarks** (Describe disturbances, relevant local variations, seasonal effects, etc.):  
*The percent of dominant species that are hydrophytic is greater than 50 percent. Hydrophytic vegetation criterion is satisfied.*

### HYDROLOGY

**Recorded Data** (Describe in Remarks):

\_\_\_\_\_ Stream, Lake, or Tide Gage  
 \_\_\_\_\_ Aerial Photograph  
 \_\_\_\_\_ Other  
X No Recorded Data Available

**Field Observations:**

Depth of Surface Water: none (in.)  
 Depth to Free Water in Pit: none (in.)  
 Depth to Saturated Soil: 1 (in.)

**Wetland Hydrology Indicators** (Describe in Remarks):

Primary Indicators:

\_\_\_\_\_ Inundated  
X Saturated in Upper 12 inches  
 \_\_\_\_\_ Water Marks  
 \_\_\_\_\_ Drift Lines  
 \_\_\_\_\_ Sediment Deposits  
 \_\_\_\_\_ Drainage Patterns in Wetlands

Secondary Indicators (2 or more required):

\_\_\_\_\_ Oxidized Rhizospheres in Upper 12 inches  
 \_\_\_\_\_ Water-Stained Leaves  
 \_\_\_\_\_ Local Soil Survey Data  
 \_\_\_\_\_ Other (Explain in Remarks)

**Remarks** (As relevant, describe recent precipitation, hydrologic modifications, local variations, etc.):  
*Site visits were conducted in January of 2008 to confirm hydrology. Saturation in the upper 12 inches satisfies wetland hydrology criterion.*

**09-25-13 Observations** - No saturated soils to at least 18 inches below the surface.

# Parametrix

Data Plot #: 25C-SP1  
Wetland: 25C

Project/Site: ELST Re-delineation Date: 11/8/2007 Revisited 09-25-13

## SOIL

### Soil Survey Data:

Map Unit Name: Alderwood gravelly sandy loam, 6 to 15 % slopes Drainage Class: Moderately well drained  
Field Observations Confirm Mapped Type?

Taxonomy (Subgroup): Entic Durochrepts Yes  No  NA

### Profile Description:

Depth (Inches)	Horizon Designation	Matrix Color (Munsell Moist)	Mottle Color (Munsell Moist)	Mottle Abundance/Contrast	Texture, Concretions, Rhizospheres, etc.
0-10	A	10YR 3/1, 10YR 5/2	10YR 5/6	common, fine, prominent	loam
10-18	B	10YR 3/1	none	none	silt loam

### Hydric Soil Indicators:

- Histosol
- Histic Epipedon
- Sulfidic Odor
- Aquic or Peraguc Moisture Regime
- Reducing Conditions
- Gleyed or Low-Chroma Colors
- High Organic Content in Surface Layer
- Listed on Hydric Soils List
- Fe/Mn Concretions
- Organic Streaking in Sandy Soils
- Mottles (Redoximorphic Features)
- Other (Explain in Remarks)

Remarks (Describe soil disturbances, local variations, etc.):  
*Chroma 1 soil and redoximorphic features indicate hydric soils.*

## WETLAND DETERMINATION

Hydrophytic Vegetation Present? Yes  No  Is this Sampling Point Within a Wetland?  
Hydric Soils Present? Yes  No  Yes  No   
Wetland Hydrology Present? Yes  No

Remarks  
*Wetland vegetation, hydrology, and soil criteria are met. Therefore, the sample plot is located in a wetland.*

# WETLAND DETERMINATION DATA FORM – Western Mountains, Valleys, and Coast Region

Project Site: ELST - South Sammamish Segment City/County: Sammamish/King Sampling Date: 10-25-13  
 Applicant/Owner: King County State: WA Sampling Point: W25D-SP1 (rev)  
 Investigator(s): C. Worsley; M. Maynard Section, Township, Range: S32, T25N, R06E  
 Landform (hillslope, terrace, etc.): shallow swale Local relief (concave, convex, none): concave Slope (%): 2  
 Subregion (LRR): A Lat: \_\_\_\_\_ Long: \_\_\_\_\_ Datum: \_\_\_\_\_  
 Soil Map Unit Name: Mixed alluvial land NWI classification: NA  
 Are climatic / hydrologic conditions on the site typical for this time of year? Yes  No  (If no, explain in Remarks.)  
 Are Vegetation , Soil , or Hydrology , significantly disturbed? Are "Normal Circumstances" present? Yes  No   
 Are Vegetation , Soil , or Hydrology , naturally problematic? (If needed, explain any answers in Remarks.)

### SUMMARY OF FINDINGS – Attach site map showing sampling point locations, transects, important features, etc.

Hydrophytic Vegetation Present?	Yes <input type="checkbox"/>	No <input checked="" type="checkbox"/>	<b>Is the Sampled Area within a Wetland?</b>	Yes <input type="checkbox"/>	No <input checked="" type="checkbox"/>
Hydric Soil Present?	Yes <input type="checkbox"/>	No <input checked="" type="checkbox"/>		Yes <input type="checkbox"/>	No <input checked="" type="checkbox"/>
Wetland Hydrology Present?	Yes <input type="checkbox"/>	No <input checked="" type="checkbox"/>		Yes <input type="checkbox"/>	No <input checked="" type="checkbox"/>
Remarks: Sample plot is located in what was previously identified as Wetland 25D. This area is no longer wetland as it does not meet the 3 wetland criteria. Sample plot is located 35 feet north of Pseudotsuga menziesii and 15 feet west of trail edge. Vegetation is routinely mowed.					

### VEGETATION – Use scientific names of plants

Tree Stratum (Plot size: <u>NA</u> )	Absolute % Cover	Dominant Species?	Indicator Status	Dominance Test Worksheet:																
1. _____	_____	_____	_____	Number of Dominant Species That Are OBL, FACW, or FAC: <u>1</u> (A)  Total Number of Dominant Species Across All Strata: <u>2</u> (B)  Percent of Dominant Species That Are OBL, FACW, or FAC: <u>50</u> (A/B)																
2. _____	_____	_____	_____																	
3. _____	_____	_____	_____																	
4. _____	_____	_____	_____																	
50% = _____, 20% = _____	_____	= Total Cover		<b>Prevalence Index worksheet:</b>  <table style="width: 100%; border: none;"> <tr> <td style="text-align: center;">Total % Cover of:</td> <td style="text-align: center;">Multiply by:</td> </tr> <tr> <td>OBL species _____</td> <td>x1 = _____</td> </tr> <tr> <td>FACW species _____</td> <td>x2 = _____</td> </tr> <tr> <td>FAC species _____</td> <td>x3 = _____</td> </tr> <tr> <td>FACU species _____</td> <td>x4 = _____</td> </tr> <tr> <td>UPL species _____</td> <td>x5 = _____</td> </tr> <tr> <td>Column Totals: _____ (A)</td> <td>_____ (B)</td> </tr> <tr> <td colspan="2" style="text-align: center;">Prevalence Index = B/A = _____</td> </tr> </table>	Total % Cover of:	Multiply by:	OBL species _____	x1 = _____	FACW species _____	x2 = _____	FAC species _____	x3 = _____	FACU species _____	x4 = _____	UPL species _____	x5 = _____	Column Totals: _____ (A)	_____ (B)	Prevalence Index = B/A = _____	
Total % Cover of:	Multiply by:																			
OBL species _____	x1 = _____																			
FACW species _____	x2 = _____																			
FAC species _____	x3 = _____																			
FACU species _____	x4 = _____																			
UPL species _____	x5 = _____																			
Column Totals: _____ (A)	_____ (B)																			
Prevalence Index = B/A = _____																				
<b>Sapling/Shrub Stratum (Plot size: <u>NA</u>)</b>																				
1. _____	_____	_____	_____																	
2. _____	_____	_____	_____																	
3. _____	_____	_____	_____																	
4. _____	_____	_____	_____																	
5. _____	_____	_____	_____																	
50% = _____, 20% = _____	_____	= Total Cover																		
<b>Herb Stratum (Plot size: <u>3 feet</u>)</b>																				
1. <u>Holcus lanatus</u>	<u>70</u>	<u>yes</u>	<u>FAC</u>																	
2. <u>Taraxacum officinale</u>	<u>25</u>	<u>yes</u>	<u>FACU</u>																	
3. <u>Ranunculus repens</u>	<u>15</u>	<u>no</u>	<u>FAC</u>																	
4. <u>Hypochaeris radicata</u>	<u>5</u>	<u>no</u>	<u>FACU</u>																	
5. <u>Other grasses</u>	<u>20</u>	<u>n/a*</u>	<u>-</u>																	
6. _____	_____	_____	_____																	
7. _____	_____	_____	_____																	
8. _____	_____	_____	_____																	
9. _____	_____	_____	_____																	
10. _____	_____	_____	_____																	
11. _____	_____	_____	_____																	
50% = <u>58</u> , 20% = <u>23</u>	<u>115</u>	= Total Cover																		
<b>Woody Vine Stratum (Plot size: <u>NA</u>)</b>																				
1. _____	_____	_____	_____																	
2. _____	_____	_____	_____																	
50% = _____, 20% = _____	_____	= Total Cover																		
% Bare Ground in Herb Stratum <u>5</u>																				

**Hydrophytic Vegetation Indicators:**

1 – Rapid Test for Hydrophytic Vegetation

2 - Dominance Test is >50%

3 - Prevalence Index is ≤3.0<sup>1</sup>

4 - Morphological Adaptations<sup>1</sup> (Provide supporting data in Remarks or on a separate sheet)

5 - Wetland Non-Vascular Plants<sup>1</sup>

Problematic Hydrophytic Vegetation<sup>1</sup> (Explain)

<sup>1</sup>Indicators of hydric soil and wetland hydrology must be present, unless disturbed or problematic.

**Hydrophytic Vegetation Present?** Yes  No

Remarks: Species with less than 5% cover are not considered dominant. Vegetation is routinely mowed. Not all of the grasses were identified due to mowing.

**SOIL**

Profile Description: (Describe to the depth needed to document the indicator or confirm the absence of indicators.)								
Depth (inches)	Matrix		Redox Features				Texture	Remarks
	Color (moist)	%	Color (moist)	%	Type <sup>1</sup>	Loc <sup>2</sup>		
0-18	10YR 3/1	100	-	-	-	-	gr. sa. loam	
<sup>1</sup> Type: C= Concentration, D=Depletion, RM=Reduced Matrix, CS=Covered or Coated Sand Grains. <sup>2</sup> Location: PL=Pore Lining, M=Matrix								
<b>Hydric Soil Indicators: (Applicable to all LRRs, unless otherwise noted.)</b>						<b>Indicators for Problematic Hydric Soils<sup>3</sup>:</b>		
<input type="checkbox"/> Histosol (A1)						<input type="checkbox"/> 2 cm Muck (A10)		
<input type="checkbox"/> Histic Epipedon (A2)						<input type="checkbox"/> Red Parent Material (TF2)		
<input type="checkbox"/> Black Histic (A3)						<input type="checkbox"/> Very Shallow Dark Surface (TF12)		
<input type="checkbox"/> Hydrogen Sulfide (A4)						<input type="checkbox"/> Other (Explain in Remarks)		
<input type="checkbox"/> Depleted Below Dark Surface (A11)						<sup>3</sup> Indicators of hydrophytic vegetation and wetland hydrology must be present, unless disturbed or problematic.		
<input type="checkbox"/> Thick Dark Surface (A12)								
<input type="checkbox"/> Sandy Mucky Mineral (S1)								
<input type="checkbox"/> Sandy Gleyed Matrix (S4)								
<input type="checkbox"/> Sandy Redox (S5)								
<input type="checkbox"/> Stripped Matrix (S6)								
<input type="checkbox"/> Loamy Mucky Mineral (F1) (except MLRA 1)								
<input type="checkbox"/> Loamy Gleyed Matrix (F2)								
<input type="checkbox"/> Depleted Matrix (F3)								
<input type="checkbox"/> Redox Dark Surface (F6)								
<input type="checkbox"/> Depleted Dark Surface (F7)								
<input type="checkbox"/> Redox Depressions (F8)								
<b>Restrictive Layer (if present):</b>					<b>Hydric Soils Present?</b>			
Type: _____					Yes <input type="checkbox"/> No <input checked="" type="checkbox"/>			
Depth (inches): _____								
Remarks: Debris/trash between 9 and 10 inches.								

**HYDROLOGY**

Wetland Hydrology Indicators:			
Primary Indicators (minimum of one required; check all that apply)		Secondary Indicators (2 or more required)	
<input type="checkbox"/> Surface Water (A1)	<input type="checkbox"/> Water-Stained Leaves (B9)	<input type="checkbox"/> Water-Stained Leaves (B9)	
<input type="checkbox"/> High Water Table (A2)	<b>(except MLRA 1, 2, 4A, and 4B)</b>	<b>(MLRA 1, 2, 4A, and 4B)</b>	
<input type="checkbox"/> Saturation (A3)	<input type="checkbox"/> Salt Crust (B11)	<input type="checkbox"/> Drainage Patterns (B10)	
<input type="checkbox"/> Water Marks (B1)	<input type="checkbox"/> Aquatic Invertebrates (B13)	<input type="checkbox"/> Dry-Season Water Table (C2)	
<input type="checkbox"/> Sediment Deposits (B2)	<input type="checkbox"/> Hydrogen Sulfide Odor (C1)	<input type="checkbox"/> Saturation Visible on Aerial Imagery (C9)	
<input type="checkbox"/> Drift Deposits (B3)	<input type="checkbox"/> Oxidized Rhizospheres along Living Roots (C3)	<input type="checkbox"/> Geomorphic Position (D2)	
<input type="checkbox"/> Algal Mat or Crust (B4)	<input type="checkbox"/> Presence of Reduced Iron (C4)	<input type="checkbox"/> Shallow Aquitard (D3)	
<input type="checkbox"/> Iron Deposits (B5)	<input type="checkbox"/> Recent Iron Reduction in Tilled Soils (C6)	<input type="checkbox"/> FAC-Neutral Test (D5)	
<input type="checkbox"/> Surface Soil Cracks (B6)	<input type="checkbox"/> Stunted or Stresses Plants (D1) (LRR A)	<input type="checkbox"/> Raised Ant Mounds (D6) (LRR A)	
<input type="checkbox"/> Inundation Visible on Aerial Imagery (B7)	<input type="checkbox"/> Other (Explain in Remarks)	<input type="checkbox"/> Frost-Heave Hummocks (D7)	
<input type="checkbox"/> Sparsely Vegetated Concave Surface (B8)			
<b>Field Observations:</b>		<b>Wetland Hydrology Present?</b>	
Surface Water Present?	Yes <input type="checkbox"/> No <input checked="" type="checkbox"/>	Yes <input type="checkbox"/> No <input checked="" type="checkbox"/>	
Water Table Present?	Yes <input type="checkbox"/> No <input checked="" type="checkbox"/>		
Saturation Present? (includes capillary fringe)	Yes <input type="checkbox"/> No <input checked="" type="checkbox"/>		
Depth (inches): _____	Depth (inches): _____		
Depth (inches): _____			
Describe Recorded Data (stream gauge, monitoring well, aerial photos, previous inspections), if available:			
Remarks:			

Exhibit 16  
SSDP2016-00415  
000905

Data Plot #: 25F-SP1  
 Wetland: 25F

## WETLAND DETERMINATION (Modified from: 1987 ACOE Wetlands Delineation Manual)

Project/Site: ELST Re-delineation Date: 11/8/2007 Revisited 09-27-13  
 Applicant/Owner: King County County: King  
 Investigator: Chip Maney, Erik Christensen State: WA

1987 Method  1977 WA St. Method Community ID: PFO  
 Do Normal Circumstances exist on the site? Yes X No        Field Plot ID: 25F-SP1  
 Is the site significantly disturbed (Atypical Situation)? Yes        No X  
 Is the area a potential Problem Area? Yes        No X

**Remarks** (Explain sample location, disturbances, problem areas):  
*This sample plot is located approximately 12 feet northeast of flag W25F-1.*

### VEGETATION (✓ Dominant species are checked)

	Plant Species	% Cover	Stratum	Indicator
1.	<u>Convolvulus arvensis</u>	<u>15</u>	<u>Herb</u>	<u>NL</u>
2.	<u>Ranunculus repens</u>	<u>15</u>	<u>Herb</u>	<u>FACW</u>
✓ 3.	<u>Cornus sericea</u>	<u>75</u>	<u>Shrub</u>	<u>FACW</u>
4.	<u>Rubus armeniacus</u>	<u>15</u>	<u>Shrub</u>	<u>FACU</u>
✓ 5.	<u>Alnus rubra</u>	<u>25</u>	<u>Tree</u>	<u>FAC</u>
✓ 6.	<u>Salix lucida</u>	<u>40</u>	<u>Tree</u>	<u>FACW+</u>

Percent of **Dominant Species** that are OBL, FACW, or FAC (except FAC-). Include species noted (\*) as showing morphological adaptations to wetlands. "T" indicates trace. 100

**Remarks** (Describe disturbances, relevant local variations, seasonal effects, etc.):  
*The percent of dominant species that are hydrophytic is greater than 50 percent. Hydrophytic vegetation criterion is satisfied.*

### HYDROLOGY

**Recorded Data** (Describe in Remarks):  
       Stream, Lake, or Tide Gage  
       Aerial Photograph  
       Other  
  X   No Recorded Data Available

**Wetland Hydrology Indicators** (Describe in Remarks):

Primary Indicators:  
       Inundated  
       Saturated in Upper 12 inches  
       Water Marks  
       Drift Lines  
       Sediment Deposits  
       Drainage Patterns in Wetlands

**Field Observations:**

Depth of Surface Water: none (in.)  
 Depth to Free Water in Pit: none (in.)  
 Depth to Saturated Soil: 8 (in.)

Secondary Indicators (2 or more required):  
       Oxidized Rhizospheres in Upper 12 inches  
       Water-Stained Leaves  
       Local Soil Survey Data  
       Other (Explain in Remarks)

**Remarks** (As relevant, describe recent precipitation, hydrologic modifications, local variations, etc.):  
*No hydrology was observed on 11/08/07. Saturation was observed at 8" during a revisit conducted on 04/18/08. Wetland hydrology criterion is satisfied.*

**09-27-13 Observations** - No saturated soils to at least 18 inches below the surface.

# Parametrix

Data Plot #: 25F-SP1  
Wetland: 25F

Project/Site: ELST Re-delineation Date: 11/8/2007 Revisited 09-27-13

## SOIL

### Soil Survey Data:

Map Unit Name: Mixed Alluvial Land Drainage Class: Well drained to very poorly drained  
Field Observations Confirm Mapped Type?

Taxonomy (Subgroup): N/A Yes  No  NA

### Profile Description:

Depth (Inches)	Horizon Designation	Matrix Color (Munsell Moist)	Mottle Color (Munsell Moist)	Mottle Abundance/Contrast	Texture, Concretions, Rhizospheres, etc.
0-10	A	10YR 2/1	none	none	silt loam
10-18	B	10YR 4/1	7.5Y 4/6	common, fine, prominent	sandy loam

### Hydric Soil Indicators:

- |   |  |
|---|--|
| <input type="checkbox"/> Histosol                               | <input type="checkbox"/> Listed on Hydric Soils List                 |
| <input type="checkbox"/> Histic Epipedon                        | <input type="checkbox"/> Fe/Mn Concretions                           |
| <input type="checkbox"/> Sulfidic Odor                          | <input type="checkbox"/> Organic Streaking in Sandy Soils            |
| <input type="checkbox"/> Aquic or Peraguc Moisture Regime       | <input checked="" type="checkbox"/> Mottles (Redoximorphic Features) |
| <input type="checkbox"/> Reducing Conditions                    | <input type="checkbox"/> Other (Explain in Remarks)                  |
| <input checked="" type="checkbox"/> Gleyed or Low-Chroma Colors |  |
| <input type="checkbox"/> High Organic Content in Surface Layer  |  |

Remarks (Describe soil disturbances, local variations, etc.):  
*Chroma 1 soil and redoximorphic features indicate hydric soils.*

## WETLAND DETERMINATION

Hydrophytic Vegetation Present? Yes  No  Is this Sampling Point Within a Wetland?  
Hydric Soils Present? Yes  No  Yes  No   
Wetland Hydrology Present? Yes  No

### Remarks

*Wetland vegetation, hydrology, and soil criteria are met. Therefore, the sample plot is located in a wetland.*

Exhibit 16  
SSDP2016-00415  
000907



Data Plot #: 26A-SP1  
 Wetland: 26A

## WETLAND DETERMINATION (Modified from: 1987 ACOE Wetlands Delineation Manual)

Project/Site: ELST Re-delineation Date: 11/9/2007 Revisited 09-27-13  
 Applicant/Owner: King County County: King  
 Investigator: Matt Maynard State: WA  
 1987 Method  1997 WA St. Method Community ID: PEM  
 Do Normal Circumstances exist on the site? Yes X No \_\_\_\_\_ Field Plot ID: 26A-SP1  
 Is the site significantly disturbed (Atypical Situation)? Yes \_\_\_\_\_ No X  
 Is the area a potential Problem Area? Yes \_\_\_\_\_ No X

**Remarks** (Explain sample location, disturbances, problem areas):  
*This sample plot is located approximately 35 feet southeast of flag W26A-13.*

### VEGETATION (✓ Dominant species are checked)

Plant Species	% Cover	Stratum	Indicator
✓ 1. <u>Phalaris arundinacea</u>	<u>100</u>	<u>Herb</u>	<u>FACW</u>
2. <u>Rubus spectabilis</u>	<u>trace</u>	<u>Shrub</u>	<u>FAC+</u>

Percent of **Dominant Species** that are OBL, FACW, or FAC (except FAC-). Include species noted (\*) as showing morphological adaptations to wetlands. "T" indicates trace. 100

**Remarks** (Describe disturbances, relevant local variations, seasonal effects, etc.):  
*The percent of dominant species that are hydrophytic is greater than 50 percent. Hydrophytic vegetation criterion is satisfied.*

### HYDROLOGY

**Recorded Data** (Describe in Remarks):  
 \_\_\_\_\_ Stream, Lake, or Tide Gage  
 \_\_\_\_\_ Aerial Photograph  
 \_\_\_\_\_ Other  
X No Recorded Data Available

**Wetland Hydrology Indicators** (Describe in Remarks):  
 Primary Indicators:  
X Inundated  
 \_\_\_\_\_ Saturated in Upper 12 inches  
 \_\_\_\_\_ Water Marks  
 \_\_\_\_\_ Drift Lines  
 \_\_\_\_\_ Sediment Deposits  
 \_\_\_\_\_ Drainage Patterns in Wetlands

**Field Observations:**

Depth of Surface Water: 1 (in.)  
 Depth to Free Water in Pit: na (in.)  
 Depth to Saturated Soil: na (in.)

Secondary Indicators (2 or more required):  
 \_\_\_\_\_ Oxidized Rhizospheres in Upper 12 inches  
 \_\_\_\_\_ Water-Stained Leaves  
 \_\_\_\_\_ Local Soil Survey Data  
 \_\_\_\_\_ Other (Explain in Remarks)

**Remarks** (As relevant, describe recent precipitation, hydrologic modifications, local variations, etc.):  
*This portion of the wetland drains south to the stream. Inundation to a depth of 1 inch satisfies wetland hydrology criterion.*

**09-27-13 Observations** - Soil saturation at surface. Free water in pit at 5 inches below surface.

# Parametrix

Data Plot #: 26A-SP1  
Wetland: 26A

Project/Site: ELST Re-delineation Date: 11/9/2007 Revisited 09-27-13

## SOIL

### Soil Survey Data:

Map Unit Name: Shalcar Muck Drainage Class: very poorly drained  
Field Observations Confirm Mapped Type?

Taxonomy (Subgroup): Terric Medisaprists Yes  No  NA

### Profile Description:

Depth (Inches)	Horizon Designation	Matrix Color (Munsell Moist)	Mottle Color (Munsell Moist)	Mottle Abundance/Contrast	Texture, Concretions, Rhizospheres, etc.
0-16	A	10YR 2/1	none	none	silt

**09-27-13 Observations - 0-20**    A    10YR 2/1    none    none    silt

### Hydric Soil Indicators:

- |   |   |
|---|---|
| <input type="checkbox"/> Histosol                               | <input type="checkbox"/> Listed on Hydric Soils List      |
| <input type="checkbox"/> Histic Epipedon                        | <input type="checkbox"/> Fe/Mn Concretions                |
| <input type="checkbox"/> Sulfidic Odor                          | <input type="checkbox"/> Organic Streaking in Sandy Soils |
| <input type="checkbox"/> Aquic or Peraguc Moisture Regime       | <input type="checkbox"/> Mottles (Redoximorphic Features) |
| <input type="checkbox"/> Reducing Conditions                    | <input type="checkbox"/> Other (Explain in Remarks)       |
| <input checked="" type="checkbox"/> Gleyed or Low-Chroma Colors |   |
| <input type="checkbox"/> High Organic Content in Surface Layer  |   |

Remarks (Describe soil disturbances, local variations, etc.):  
*Chroma 1 soil indicates hydric soils.*

## WETLAND DETERMINATION

Hydrophytic Vegetation Present?    Yes  No     Is this Sampling Point Within a Wetland?  
Hydric Soils Present?    Yes  No     Yes  No   
Wetland Hydrology Present?    Yes  No

Remarks  
*Wetland vegetation, hydrology, and soil criteria are met. Therefore, the sample plot is located in a wetland.*

Data Plot #: 26A-SP2  
 Wetland: 26A

## WETLAND DETERMINATION (Modified from: 1987 ACOE Wetlands Delineation Manual)

Project/Site: ELST Re-delineation Date: 11/9/2007 Revisited 09-27-13  
 Applicant/Owner: King County County: King  
 Investigator: Chip Maney, Erik Christensen State: WA  
 1987 Method  1977 WA St. Method Community ID: PSS  
 Do Normal Circumstances exist on the site? Yes X No \_\_\_\_\_ Field Plot ID: 26A-SP2  
 Is the site significantly disturbed (Atypical Situation)? Yes \_\_\_\_\_ No X  
 Is the area a potential Problem Area? Yes \_\_\_\_\_ No X

**Remarks** (Explain sample location, disturbances, problem areas):  
*This sample plot is located 6 feet east of flag W26A-4.*

### VEGETATION (✓ Dominant species are checked)

Plant Species	% Cover	Stratum	Indicator
✓ 1. <u>Phalaris arundinacea</u>	<u>60</u>	<u>Herb</u>	<u>FACW</u>
2. <u>Rubus armeniacus</u>	<u>5</u>	<u>Shrub</u>	<u>FACU</u>
3. <u>Rubus spectabilis</u>	<u>15</u>	<u>Shrub</u>	<u>FAC+</u>
✓ 4. <u>Salix lucida</u>	<u>60</u>	<u>Shrub</u>	<u>FACW+</u>
5. <u>Spiraea douglasii</u>	<u>15</u>	<u>Shrub</u>	<u>FACW</u>
✓ 6. <u>Acer macrophyllum*</u>	<u>90</u>	<u>Tree</u>	<u>FACU</u>

**09-27-13 Observations**  
 Phalaris arundinacea 40%  
 Rubus armeniacus 5%  
 Rubus spectabilis 15%  
 Salix lucida 60%  
 Spiraea douglasii 15%  
 Acer macrophyllum (overhanging) 90%

Percent of **Dominant Species** that are OBL, FACW, or FAC (except FAC-). Include species noted (\*) as showing morphological adaptations to wetlands. "T" indicates trace. 100

**Remarks** (Describe disturbances, relevant local variations, seasonal effects, etc.):  
*\*Acer macrophyllum was rooted outside of the wetland but was overhanging to provide 90 percent cover. The percent of dominant species that are hydrophytic is greater than 50 percent. Hydrophytic vegetation criterion is satisfied.*

### HYDROLOGY

**Recorded Data** (Describe in Remarks):  
 \_\_\_\_\_ Stream, Lake, or Tide Gage  
 \_\_\_\_\_ Aerial Photograph  
 \_\_\_\_\_ Other  
X No Recorded Data Available

**Wetland Hydrology Indicators** (Describe in Remarks):  
 Primary Indicators:  
X Inundated  
 \_\_\_\_\_ Saturated in Upper 12 inches  
 \_\_\_\_\_ Water Marks  
 \_\_\_\_\_ Drift Lines  
 \_\_\_\_\_ Sediment Deposits  
 \_\_\_\_\_ Drainage Patterns in Wetlands

**Field Observations:**

Depth of Surface Water: 2 (in.)  
 Depth to Free Water in Pit: na (in.)  
 Depth to Saturated Soil: na (in.)

Secondary Indicators (2 or more required):  
 \_\_\_\_\_ Oxidized Rhizospheres in Upper 12 inches  
 \_\_\_\_\_ Water-Stained Leaves  
 \_\_\_\_\_ Local Soil Survey Data  
 \_\_\_\_\_ Other (Explain in Remarks)

**Remarks** (As relevant, describe recent precipitation, hydrologic modifications, local variations, etc.):  
*Inundation to a depth of 2 inches satisfies wetland hydrology criterion.*

**09-27-13 Observations** - Soil saturation at surface. No inundation or free water in pit.

# Parametrix

Data Plot #: 26A-SP2  
 Wetland: 26A

Project/Site: ELST Re-delineation Date: 11/9/2007 Revisited 09-27-13

## SOIL

### Soil Survey Data:

Map Unit Name: Shalcar Muck Drainage Class: very poorly drained  
 Field Observations Confirm Mapped Type?  
 Yes  No  NA

Taxonomy (Subgroup): Terric Medisaprists

### Profile Description:

Depth (Inches)	Horizon Designation	Matrix Color (Munsell Moist)	Mottle Color (Munsell Moist)	Mottle Abundance/Contrast	Texture, Concretions, Rhizospheres, etc.
0-10	A	10YR 3/1	none	none	loam
10-18	B	10YR 3/1	10YR 5/6	common, fine, prominent	silt loam

09-27-13 Observations							
0-10	A	10YR 3/1	none	none	loam		
10-18	B	10YR 4/1 (40%) 10YR 5/1 (40%)	10YR 5/6	20%	silt loam		

### Hydric Soil Indicators:

- |   |  |
|---|--|
| <input type="checkbox"/> Histosol                               | <input type="checkbox"/> Listed on Hydric Soils List                 |
| <input type="checkbox"/> Histic Epipedon                        | <input type="checkbox"/> Fe/Mn Concretions                           |
| <input type="checkbox"/> Sulfidic Odor                          | <input type="checkbox"/> Organic Streaking in Sandy Soils            |
| <input type="checkbox"/> Aquic or Peraguc Moisture Regime       | <input checked="" type="checkbox"/> Mottles (Redoximorphic Features) |
| <input type="checkbox"/> Reducing Conditions                    | <input type="checkbox"/> Other (Explain in Remarks)                  |
| <input checked="" type="checkbox"/> Gleyed or Low-Chroma Colors |  |
| <input type="checkbox"/> High Organic Content in Surface Layer  |  |

Remarks (Describe soil disturbances, local variations, etc.):  
*Chroma 1 soil and redoximorphic features indicate hydric soils.*

## WETLAND DETERMINATION

Hydrophytic Vegetation Present?	Yes <input checked="" type="checkbox"/> No <input type="checkbox"/>	Is this Sampling Point Within a Wetland?
Hydric Soils Present?	Yes <input checked="" type="checkbox"/> No <input type="checkbox"/>	Yes <input checked="" type="checkbox"/> No <input type="checkbox"/>
Wetland Hydrology Present?	Yes <input checked="" type="checkbox"/> No <input type="checkbox"/>	

### Remarks

*Wetland vegetation, hydrology, and soil criteria are met. Therefore, the sample plot is located in a wetland.*

Data Plot #: 26A-SP3  
 Wetland: Upland near 26A

## WETLAND DETERMINATION (Modified from: 1987 ACOE Wetlands Delineation Manual)

Project/Site: ELST Re-delineation Date: 11/9/2007 Revisited 09-27-13  
 Applicant/Owner: King County County: King  
 Investigator: Chip Maney, Erik Christensen State: WA  
 1987 Method  1997 WA St. Method Community ID: Upland Shrub  
 Do Normal Circumstances exist on the site? Yes X No \_\_\_\_\_ Field Plot ID: 26A-SP3  
 Is the site significantly disturbed (Atypical Situation)? Yes \_\_\_\_\_ No X  
 Is the area a potential Problem Area? Yes \_\_\_\_\_ No X

**Remarks** (Explain sample location, disturbances, problem areas):  
*This sample plot is located approximately 10 feet north of flag W26A-2.*

### VEGETATION (✓ Dominant species are checked)

Plant Species	% Cover	Stratum	Indicator
✓ 1. <u>Phalaris arundinacea</u>	<u>20</u>	<u>Herb</u>	<u>FACW</u>
2. <u>Rosa pisocarpa</u>	<u>10</u>	<u>Shrub</u>	<u>FAC</u>
✓ 3. <u>Rubus armeniacus</u>	<u>40</u>	<u>Shrub</u>	<u>FACU</u>
✓ 4. <u>Spiraea douglasii</u>	<u>40</u>	<u>Shrub</u>	<u>FACW</u>

### 09-27-13 Observations

Equisetum telmateia 20%  
 Equisetum hyemale 5%  
 Polystichum munitum 5%  
 Calystegia sepium 5%  
 Rubus armeniacus 80%  
 Acer macrophyllum 80%

Percent of **Dominant Species** that are OBL, FACW, or FAC (except FAC-). Include species noted (\*) as showing morphological adaptations to wetlands. "T" indicates trace. 67

**Remarks** (Describe disturbances, relevant local variations, seasonal effects, etc.):  
*The percent of dominant species that are hydrophytic is greater than 50 percent. Hydrophytic vegetation criterion is satisfied.*

### HYDROLOGY

#### Recorded Data (Describe in Remarks):

\_\_\_\_\_ Stream, Lake, or Tide Gage  
 \_\_\_\_\_ Aerial Photograph  
 \_\_\_\_\_ Other  
X No Recorded Data Available

#### Wetland Hydrology Indicators (Describe in Remarks):

Primary Indicators:  
 \_\_\_\_\_ Inundated  
 \_\_\_\_\_ Saturated in Upper 12 inches  
 \_\_\_\_\_ Water Marks  
 \_\_\_\_\_ Drift Lines  
 \_\_\_\_\_ Sediment Deposits  
 \_\_\_\_\_ Drainage Patterns in Wetlands

#### Field Observations:

Depth of Surface Water: none (in.)  
 Depth to Free Water in Pit: none (in.)  
 Depth to Saturated Soil: none (in.)

Secondary Indicators (2 or more required):  
 \_\_\_\_\_ Oxidized Rhizospheres in Upper 12 inches  
 \_\_\_\_\_ Water-Stained Leaves  
 \_\_\_\_\_ Local Soil Survey Data  
 \_\_\_\_\_ Other (Explain in Remarks)

**Remarks** (As relevant, describe recent precipitation, hydrologic modifications, local variations, etc.):  
*No primary or secondary indicators of hydrology are present. Wetland hydrology criterion is not satisfied.*

**09-27-13 Observations** - No hydrology indicators present.

# Parametrix

**Data Plot #:** 26A-SP3  
**Wetland:** Upland near 26A

Project/Site: ELST Re-delineation Date: 11/9/2007 Revisited 09-27-13

## SOIL

### Soil Survey Data:

Map Unit Name: Shalcar Muck Drainage Class: very poorly drained  
 Field Observations Confirm Mapped Type?  
 Yes  No  NA

Taxonomy (Subgroup): Terric Medisaprists

### Profile Description:

Depth (Inches)	Horizon Designation	Matrix Color (Munsell Moist)	Mottle Color (Munsell Moist)	Mottle Abundance/Contrast	Texture, Concretions, Rhizospheres, etc.
0-10	A	10YR 3/2	7.5YR 4/6	common, fine-coarse, prominent	loam
10-18	B	10YR 4/2	none	none	loam

<b>09-27-13 Observations</b>		0-18	A	10YR 3/2	none	none	sa. loam
		18-20	B	10YR 4/4	none	none	gr. sa. loam

### Hydric Soil Indicators:

- |  |   |
|--|---|
| <input type="checkbox"/> Histosol<br><input type="checkbox"/> Histic Epipedon<br><input type="checkbox"/> Sulfidic Odor<br><input type="checkbox"/> Aquic or Peraguc Moisture Regime<br><input type="checkbox"/> Reducing Conditions<br><input type="checkbox"/> Gleyed or Low-Chroma Colors<br><input type="checkbox"/> High Organic Content in Surface Layer | <input type="checkbox"/> Listed on Hydric Soils List<br><input type="checkbox"/> Fe/Mn Concretions<br><input type="checkbox"/> Organic Streaking in Sandy Soils<br><input type="checkbox"/> Mottles (Redoximorphic Features)<br><input type="checkbox"/> Other (Explain in Remarks) |
|--|---|

**Remarks** (Describe soil disturbances, local variations, etc.):  
*No indicators of hydric soil are present. Hydric soil criterion is not satisfied.*

## WETLAND DETERMINATION

Hydrophytic Vegetation Present?	Yes <input checked="" type="checkbox"/> No <input type="checkbox"/>	<b>Is this Sampling Point Within a Wetland?</b>
Hydric Soils Present?	Yes <input type="checkbox"/> No <input checked="" type="checkbox"/>	Yes <input type="checkbox"/> No <input checked="" type="checkbox"/>
Wetland Hydrology Present?	Yes <input type="checkbox"/> No <input checked="" type="checkbox"/>	

**Remarks**  
*Wetland hydrology and hydric soil criterion are not satisfied. Therefore, the sample plot is not located in a wetland.*

Data Plot #: 26B-SP1  
 Wetland: 26B

## WETLAND DETERMINATION (Modified from: 1987 ACOE Wetlands Delineation Manual)

Project/Site: ELST Re-delineation Date: 11/2/2007 Revisited 03-20-14  
 Applicant/Owner: King County County: King County  
 Investigator: Linda Krippner/Rachel Hulscher State: WA  
 1987 Method  1997 WA St. Method Community ID: PEM  
 Do Normal Circumstances exist on the site? Yes      No X Field Plot ID: 26B-SP1  
 Is the site significantly disturbed (Atypical Situation)? Yes X No       
 Is the area a potential Problem Area? Yes      No X

**Remarks** (Explain sample location, disturbances, problem areas):

*Vegetation has been highly modified by human disturbance and the wetland is in an atypical situation. Vegetation is not used in the wetland determination. This sample plot is located approximately 10 feet west of Flag 26B-2. Flat, 0% Slope*

**VEGETATION** (✓ Dominant species are checked)

Plant Species	% Cover	Stratum	Indicator
1. <u>Geranium robertianum</u>	<u>10</u>	<u>Herb</u>	<u>NL</u>
✓ 2. <u>Phalaris arundinacea</u>	<u>20</u>	<u>Herb</u>	<u>FACW</u>
✓ 3. <u>Poa spp.</u>	<u>40</u>	<u>Herb</u>	<u>    </u>
✓ 4. <u>Taraxacum officinale</u>	<u>80</u>	<u>Herb</u>	<u>FACU</u>
✓ 5. <u>Rubus armeniacus</u>	<u>30</u>	<u>Shrub</u>	<u>FACU</u>

**03-20-14 Observations**

Trifolium repens 40%  
 Agrostis capillaris 30%  
 Poa spp. 30%  
 Holcus lanatus 10%  
 Scirpus microcarpus 5%  
 Taraxacum officinale 5%

Percent of **Dominant Species** that are OBL, FACW, or FAC (except FAC-). Include species noted (\*) as showing morphological adaptations to wetlands. "T" indicates trace. 33

**Remarks** (Describe disturbances, relevant local variations, seasonal effects, etc.):

*The percent of dominant species that are hydrophytic is not greater than 50 percent. Hydrophytic vegetation criterion is not satisfied. The lawn is dominated by dandelions, framed by a mix of apple trees to north, and Rubus armeniacus /Phalaris arundinacea to east. Disturbed site has weeds and planted vegetation (Pompos grass).*

**HYDROLOGY**

**Recorded Data** (Describe in Remarks):

     Stream, Lake, or Tide Gage  
     Aerial Photograph  
     Other  
X No Recorded Data Available

**Wetland Hydrology Indicators** (Describe in Remarks):

Primary Indicators:  
     Inundated  
X Saturated in Upper 12 inches  
     Water Marks  
     Drift Lines  
     Sediment Deposits  
     Drainage Patterns in Wetlands

**Field Observations:**

Depth of Surface Water: none (in.)  
 Depth to Free Water in Pit: none (in.)  
 Depth to Saturated Soil: 9 (in.)

Secondary Indicators (2 or more required):

     Oxidized Rhizospheres in Upper 12 inches  
     Water-Stained Leaves  
     Local Soil Survey Data  
     Other (Explain in Remarks)

**Remarks** (As relevant, describe recent precipitation, hydrologic modifications, local variations, etc.):

*Soil saturation in the upper 12 inches satisfies wetland hydrology criterion.*

**03-20-14 Observations** - Soil saturation at 9 inches. Free water in pit at 9 inches below surface.

# Parametrix

Data Plot #: 26B-SP1

Wetland: 26B

Project/Site: ELST Re-delineation

Date: 11/2/2007

Revisited 03-20-14

## SOIL

### Soil Survey Data:

Map Unit Name: Shalcar Muck

Drainage Class: very poorly drained

Field Observations Confirm Mapped Type?

Taxonomy (Subgroup): Terric Medisaprists

Yes  No  NA

### Profile Description:

Depth (Inches)	Horizon Designation	Matrix Color (Munsell Moist)	Mottle Color (Munsell Moist)	Mottle Abundance/Contrast	Texture, Concretions, Rhizospheres, etc.
0-12	A	10YR 2/1	none	none	sandy loam
12-16	B	2.5Y 3/2	10YR 5/6	few, medium, distinct	sand

**03-20-14 Observations** - 0-12 A 10YR 2/1 none none sa. loam  
12-16 B 2.5Y 4/2 (85%) 10YR 5/6 15% sand

### Hydric Soil Indicators:

<input type="checkbox"/> Histosol	<input type="checkbox"/> Listed on Hydric Soils List
<input type="checkbox"/> Histic Epipedon	<input type="checkbox"/> Fe/Mn Concretions
<input type="checkbox"/> Sulfidic Odor	<input type="checkbox"/> Organic Streaking in Sandy Soils
<input type="checkbox"/> Aquic or Peraguc Moisture Regime	<input checked="" type="checkbox"/> Mottles (Redoximorphic Features)
<input type="checkbox"/> Reducing Conditions	<input type="checkbox"/> Other (Explain in Remarks)
<input checked="" type="checkbox"/> Gleyed or Low-Chroma Colors	
<input type="checkbox"/> High Organic Content in Surface Layer	

Remarks (Describe soil disturbances, local variations, etc.):

*Low chroma, redoximorphic features although site is disturbed.*

## WETLAND DETERMINATION

Hydrophytic Vegetation Present?

Yes  No

Is this Sampling Point Within a Wetland?

Hydric Soils Present?

Yes  No

Yes  No

Wetland Hydrology Present?

Yes  No

### Remarks

*Vegetation has been highly modified by human disturbance. Vegetation is not used in the wetland determination. Hydric soil and wetland hydrology criteria are satisfied. The area has been determined to be wetland based on best professional judgement.*

**Exhibit 16**  
**SSDP2016-00415**  
**000915**



Data Plot #: 26B-SP-2  
Wetland: Upland near 26B

## WETLAND DETERMINATION (Modified from: 1987 ACOE Wetlands Delineation Manual)

Project/Site: ELST Re-delineation Date: 11/2/2007 Revised 03-20-14  
Applicant/Owner: King County County: King County  
Investigator: Linda Krippner/Rachel Hulscher State: WA  
 1987 Method  1997 WA St. Method Community ID: Upland Shrub/Herb  
Do Normal Circumstances exist on the site? Yes X No \_\_\_\_\_ Field Plot ID: 26B-SP2  
Is the site significantly disturbed (Atypical Situation)? Yes \_\_\_\_\_ No X  
Is the area a potential Problem Area? Yes \_\_\_\_\_ No X

**Remarks** (Explain sample location, disturbances, problem areas):

*This sample plot is located near the trail. This sample plot is located approximately 6 feet south of Flag 26B-2.*

### VEGETATION (✓ Dominant species are checked)

Plant Species	% Cover	Stratum	Indicator
1. <u>Equisetum telmateia</u>	<u>10</u>	<u>Herb</u>	<u>FACW</u>
✓ 2. <u>Pampas grass</u>	<u>20</u>	<u>Herb</u>	<u>NL</u>
✓ 3. <u>Phalaris arundinacea</u>	<u>50</u>	<u>Herb</u>	<u>FACW</u>
✓ 4. <u>Rubus armeniacus</u>	<u>60</u>	<u>Shrub</u>	<u>FACU</u>
5. <u>Malus spp.</u>	<u>10</u>	<u>Tree</u>	_____

#### 03-20-14 Observations

Phalaris arundinacea 25%  
Poa spp. 20%  
Agrostis capillaris 20%  
Festuca arundinacea 10%  
Taraxacum officinale 5%

Percent of **Dominant Species** that are OBL, FACW, or FAC (except FAC-). Include species noted (\*) as showing morphological adaptations to wetlands. "T" indicates trace. 33

**Remarks** (Describe disturbances, relevant local variations, seasonal effects, etc.):

*The percent of dominant species that are hydrophytic is not greater than 50 percent. Hydrophytic vegetation criterion is not satisfied. Although the vegetation is very disturbed.*

### HYDROLOGY

**Recorded Data** (Describe in Remarks):

\_\_\_\_\_ Stream, Lake, or Tide Gage  
\_\_\_\_\_ Aerial Photograph  
\_\_\_\_\_ Other  
X No Recorded Data Available

**Wetland Hydrology Indicators** (Describe in Remarks):

Primary Indicators:

\_\_\_\_\_ Inundated  
\_\_\_\_\_ Saturated in Upper 12 inches  
\_\_\_\_\_ Water Marks  
\_\_\_\_\_ Drift Lines  
\_\_\_\_\_ Sediment Deposits  
\_\_\_\_\_ Drainage Patterns in Wetlands

Secondary Indicators (2 or more required):

\_\_\_\_\_ Oxidized Rhizospheres in Upper 12 inches  
\_\_\_\_\_ Water-Stained Leaves  
\_\_\_\_\_ Local Soil Survey Data  
\_\_\_\_\_ Other (Explain in Remarks)

**Field Observations:**

Depth of Surface Water: none (in.)  
Depth to Free Water in Pit: none (in.)  
Depth to Saturated Soil: none (in.)

**Remarks** (As relevant, describe recent precipitation, hydrologic modifications, local variations, etc.):

*No primary or secondary indicators of hydrology are present. Wetland hydrology criterion is not satisfied.*

**03-20-14 Observations** - Soil saturation at 14 inches. No inundation or free water in pit.

# Parametrix

**Data Plot #:** 26B-SP-2  
**Wetland:** Upland near 26B

Project/Site: ELST Re-delineation Date: 11/2/2007 Revisited 03-20-14

## SOIL

### Soil Survey Data:

Map Unit Name: Shalcar Muck Drainage Class: very poorly drained  
 Field Observations Confirm Mapped Type?  
 Yes  No  NA

Taxonomy (Subgroup): Terric Medisaprists

### Profile Description:

Depth (Inches)	Horizon Designation	Matrix Color (Munsell Moist)	Mottle Color (Munsell Moist)	Mottle Abundance/Contrast	Texture, Concretions, Rhizospheres, etc.
0-15	A	10YR 3/2	none	none	gravelly sandy loam

03-20-14 Observations							
0-15	A	10YR 2/1	none	none	gr. loam		
15-19	B	2.5Y 4/3	none	none	sand		

### Hydric Soil Indicators:

- |  |   |
|--|---|
| <input type="checkbox"/> Histosol                              | <input type="checkbox"/> Listed on Hydric Soils List      |
| <input type="checkbox"/> Histic Epipedon                       | <input type="checkbox"/> Fe/Mn Concretions                |
| <input type="checkbox"/> Sulfidic Odor                         | <input type="checkbox"/> Organic Streaking in Sandy Soils |
| <input type="checkbox"/> Aquic or Peraguc Moisture Regime      | <input type="checkbox"/> Mottles (Redoximorphic Features) |
| <input type="checkbox"/> Reducing Conditions                   | <input type="checkbox"/> Other (Explain in Remarks)       |
| <input type="checkbox"/> Gleyed or Low-Chroma Colors           |   |
| <input type="checkbox"/> High Organic Content in Surface Layer |   |

**Remarks** (Describe soil disturbances, local variations, etc.):  
*No hydric soil indicators are present. Hydric soil criterion is not satisfied.*

## WETLAND DETERMINATION

<b>Hydrophytic Vegetation Present?</b>	Yes <input type="checkbox"/> No <input checked="" type="checkbox"/>	<b>Is this Sampling Point Within a Wetland?</b> Yes <input type="checkbox"/> No <input checked="" type="checkbox"/>
<b>Hydric Soils Present?</b>	Yes <input type="checkbox"/> No <input checked="" type="checkbox"/>	
<b>Wetland Hydrology Present?</b>	Yes <input type="checkbox"/> No <input checked="" type="checkbox"/>	

**Remarks**  
*Wetland vegetation, hydrology, and soil criteria are not met. Therefore, the sample plot is not located in a wetland.*

Data Plot #: 26C-SP1  
 Wetland: 26C

## WETLAND DETERMINATION (Modified from: 1987 ACOE Wetlands Delineation Manual)

Project/Site: ELST Re-delineation Date: 11/2/2007 Revisited 03-20-14  
 Applicant/Owner: King County County: King County  
 Investigator: Linda Krippner/Rachel Hulscher State: WA  
 1987 Method  1997 WA St. Method Community ID: PEM  
 Do Normal Circumstances exist on the site? Yes X No        Field Plot ID: 26C-SP1  
 Is the site significantly disturbed (Atypical Situation)? Yes        No X  
 Is the area a potential Problem Area? Yes        No X

**Remarks** (Explain sample location, disturbances, problem areas):  
*This sample plot is located approximately 3 feet west of Flag 26C-2.*

### VEGETATION (✓ Dominant species are checked)

Plant Species	% Cover	Stratum	Indicator
✓ 1. <u>Trifolium repens</u>	<u>30</u>	<u>      </u>	<u>FAC*</u>
✓ 2. <u>Agrostis spp.</u>	<u>50</u>	<u>Herb</u>	<u>FAC</u>
3. <u>dandelion</u>	<u>10</u>	<u>Herb</u>	<u>FACU</u>
✓ 4. <u>Phalaris arundinacea</u>	<u>30</u>	<u>Herb</u>	<u>FACW</u>
✓ 5. <u>Poa spp.</u>	<u>50</u>	<u>Herb</u>	<u>UNK</u>
✓ 6. <u>Ranunculus repens</u>	<u>40</u>	<u>Herb</u>	<u>FACW</u>

### 03-20-14 Observations

Agrostis spp. 50%  
 Taraxacum officinale 10%  
 Phalaris arundinacea 30%  
 Poa spp. 50%  
 Ranunculus repens 40%

Percent of **Dominant Species** that are OBL, FACW, or FAC (except FAC-). Include species noted (\*) as showing morphological adaptations to wetlands. "T" indicates trace. 100

**Remarks** (Describe disturbances, relevant local variations, seasonal effects, etc.):  
*The percent of dominant species that are hydrophytic is greater than 50 percent. Therefore, the hydrophytic vegetation criterion is satisfied. Most of wetland slope is lawn and apple orchard, rimmed with Phalaris arundinacea.*

### HYDROLOGY

**Recorded Data** (Describe in Remarks):  
       Stream, Lake, or Tide Gage  
       Aerial Photograph  
       Other  
X No Recorded Data Available

**Wetland Hydrology Indicators** (Describe in Remarks):  
 Primary Indicators:  
       Inundated  
X Saturated in Upper 12 inches  
       Water Marks  
       Drift Lines  
       Sediment Deposits  
       Drainage Patterns in Wetlands

#### Field Observations:

Depth of Surface Water: none (in.)  
 Depth to Free Water in Pit: 14 (in.)  
 Depth to Saturated Soil: 9 (in.)

Secondary Indicators (2 or more required):  
       Oxidized Rhizospheres in Upper 12 inches  
       Water-Stained Leaves  
       Local Soil Survey Data  
       Other (Explain in Remarks)

**Remarks** (As relevant, describe recent precipitation, hydrologic modifications, local variations, etc.):  
*Soil saturation in the upper 12 inches satisfies the wetland hydrology criterion.*

**03-20-14 Observations** - Soil saturation at surface. Free water in pit at 3 inches below surface. Standing water in micro-depressions.

# Parametrix

Data Plot #: 26C-SP1  
 Wetland: 26C

Project/Site: ELST Re-delineation Date: 11/2/2007 Revisited 03-20-14

## SOIL

### Soil Survey Data:

Map Unit Name: Shalcar Muck Drainage Class: Moderately well drained  
 Field Observations Confirm Mapped Type?  
 Taxonomy (Subgroup): Terric Medisaprists Yes  No  NA

### Profile Description:

Depth (Inches)	Horizon Designation	Matrix Color (Munsell Moist)	Mottle Color (Munsell Moist)	Mottle Abundance/Contrast	Texture, Concretions, Rhizospheres, etc.
0-16	A	10YR 3/1	10YR 3/6	many, medium, distinct	gravelly sandy loam
<b>03-20-14 Observations</b> - 0-6 10YR 3/1 10YR5/8 20% si. loam					
6-12 10YR 3/1 10YR5/8 20% lo. sand					
12-18 10YR 2/1 none none loam					

**Remarks** - Gravel in upper 12 inches.

### Hydric Soil Indicators:

- |   |   |
|---|---|
| <input type="checkbox"/> Histosol                               | <input type="checkbox"/> Listed on Hydric Soils List      |
| <input type="checkbox"/> Histic Epipedon                        | <input type="checkbox"/> Fe/Mn Concretions                |
| <input type="checkbox"/> Sulfidic Odor                          | <input type="checkbox"/> Organic Streaking in Sandy Soils |
| <input type="checkbox"/> Aquic or Peraguc Moisture Regime       | <input type="checkbox"/> Mottles (Redoximorphic Features) |
| <input type="checkbox"/> Reducing Conditions                    | <input type="checkbox"/> Other (Explain in Remarks)       |
| <input checked="" type="checkbox"/> Gleyed or Low-Chroma Colors |   |
| <input type="checkbox"/> High Organic Content in Surface Layer  |   |

**Remarks** (Describe soil disturbances, local variations, etc.):  
*Low-chroma soil matrix color and redoximorphic features indicate hydric soils.*

## WETLAND DETERMINATION

Hydrophytic Vegetation Present? Yes  No  Is this Sampling Point Within a Wetland?  
 Hydric Soils Present? Yes  No  Yes  No   
 Wetland Hydrology Present? Yes  No

**Remarks**  
*Wetland vegetation, hydrology, and soil criteria are met. Therefore, the sample plot is located in a wetland.*

Data Plot #: 26C-SP2  
 Wetland: Upland near 26C

## WETLAND DETERMINATION (Modified from: 1987 ACOE Wetlands Delineation Manual)

Project/Site: ELST Re-delineation Date: 11/2/2007 Revisited 03-20-14  
 Applicant/Owner: King County County: King County  
 Investigator: Linda Krippner/Rachel Hulscher State: WA  
 1987 Method  1997 WA St. Method Community ID: Upland Herb  
 Do Normal Circumstances exist on the site? Yes X No \_\_\_\_\_ Field Plot ID: 26C-SP2  
 Is the site significantly disturbed (Atypical Situation)? Yes \_\_\_\_\_ No X  
 Is the area a potential Problem Area? Yes \_\_\_\_\_ No X

**Remarks** (Explain sample location, disturbances, problem areas):

*This upland plot is located on same elevation as trail and adjacent to the trail along an orchard and planted tree hedge. The wetland plot is at a lower elevation.*  
*This sample plot is located approximately 7 feet south of Flag 26B-2.* Located approximately 8 feet north of Abies amabilis row at toe of fill slope of trail.

**VEGETATION** (✓ Dominant species are checked)

Plant Species	% Cover	Stratum	Indicator
✓ 1. <u>Agrostis spp.</u>	<u>30</u>	<u>Herb</u>	<u>FAC</u>
✓ 2. <u>Equisetum telmateia</u>	<u>20</u>	<u>Herb</u>	<u>FACW</u>
✓ 3. <u>Phalaris arundinacea</u>	<u>40</u>	<u>Herb</u>	<u>FACW</u>
✓ 4. <u>Poa spp.</u>	<u>30</u>	<u>Herb</u>	<u>UNK</u>
✓ 5. <u>Rubus armeniacus</u>	<u>30</u>	<u>Herb</u>	<u>FACU</u>
6. <u>Abies amabilis</u>	<u>10</u>	<u>Tree</u>	<u>FACU</u>
✓ 7. <u>Malus sp.</u>	<u>40</u>	<u>Tree/Shrub</u>	<u>NL</u>

**03-20-14 Observations**

Agrostis spp. 30%  
 Equisetum telmateia 20%  
 Phalaris arundinacea 40%  
 Poa spp. 30%  
 Rubus armeniacus 10%  
 Abies amabilis 15%  
 Malus sp. 40%

Percent of **Dominant Species** that are OBL, FACW, or FAC (except FAC-). Include species noted (\*) as showing morphological adaptations to wetlands. "T" indicates trace. 50

**Remarks** (Describe disturbances, relevant local variations, seasonal effects, etc.):

*The percent of dominant species that are hydrophytic is not greater than 50 percent. Hydrophytic vegetation criterion is not satisfied.*

### HYDROLOGY

**Recorded Data** (Describe in Remarks):

\_\_\_\_\_ Stream, Lake, or Tide Gage  
 \_\_\_\_\_ Aerial Photograph  
 \_\_\_\_\_ Other  
X No Recorded Data Available

**Wetland Hydrology Indicators** (Describe in Remarks):

Primary Indicators:  
 \_\_\_\_\_ Inundated  
 \_\_\_\_\_ Saturated in Upper 12 inches  
 \_\_\_\_\_ Water Marks  
 \_\_\_\_\_ Drift Lines  
 \_\_\_\_\_ Sediment Deposits  
 \_\_\_\_\_ Drainage Patterns in Wetlands

**Field Observations:**

Depth of Surface Water: none (in.)  
 Depth to Free Water in Pit: none (in.)  
 Depth to Saturated Soil: none (in.)

Secondary Indicators (2 or more required):  
 \_\_\_\_\_ Oxidized Rhizospheres in Upper 12 inches  
 \_\_\_\_\_ Water-Stained Leaves  
 \_\_\_\_\_ Local Soil Survey Data  
 \_\_\_\_\_ Other (Explain in Remarks)

**Remarks** (As relevant, describe recent precipitation, hydrologic modifications, local variations, etc.):

*Soils were not saturated. No primary or secondary indicators of hydrology are present. Wetland hydrology criterion is not satisfied.*

# Parametrix

Data Plot #: 26C-SP2  
Wetland: Upland near 26C

Project/Site: ELST Re-delineation Date: 11/2/2007 Revisited 03-20-14

## SOIL

### Soil Survey Data:

Map Unit Name: Shalcar Muck Drainage Class: Moderately well drained  
Field Observations Confirm Mapped Type?

Taxonomy (Subgroup): Terric Medisaprists Yes  No  NA

### Profile Description:

Depth (Inches)	Horizon Designation	Matrix Color (Munsell Moist)	Mottle Color (Munsell Moist)	Mottle Abundance/Contrast	Texture, Concretions, Rhizospheres, etc.
0-16	A	10YR 3/2	none	none	sandy loam

### Hydric Soil Indicators:

- |  |   |
|--|---|
| <input type="checkbox"/> Histosol                              | <input type="checkbox"/> Listed on Hydric Soils List      |
| <input type="checkbox"/> Histic Epipedon                       | <input type="checkbox"/> Fe/Mn Concretions                |
| <input type="checkbox"/> Sulfidic Odor                         | <input type="checkbox"/> Organic Streaking in Sandy Soils |
| <input type="checkbox"/> Aquic or Peraguc Moisture Regime      | <input type="checkbox"/> Mottles (Redoximorphic Features) |
| <input type="checkbox"/> Reducing Conditions                   | <input type="checkbox"/> Other (Explain in Remarks)       |
| <input type="checkbox"/> Gleyed or Low-Chroma Colors           |   |
| <input type="checkbox"/> High Organic Content in Surface Layer |   |

Remarks (Describe soil disturbances, local variations, etc.):  
*No hydric soil indicators are present. Hydric soil criterion is not satisfied.*

## WETLAND DETERMINATION

Hydrophytic Vegetation Present? Yes  No  **Is this Sampling Point Within a Wetland?**  
Hydric Soils Present? Yes  No  Yes  No   
Wetland Hydrology Present? Yes  No

Remarks  
*None of three of the wetland criteria are met. Therefore, the sample plot is not located in a wetland.*

# WETLAND DETERMINATION DATA FORM – Western Mountains, Valleys, and Coast Region

Project Site: ELST - South Sammamish Segment City/County: Sammamish/King Sampling Date: 03-20-14  
 Applicant/Owner: King County State: WA Sampling Point: W26C-SP3  
 Investigator(s): C. Worsley, K. Seckel Section, Township, Range: S32, T25N, R06E  
 Landform (hillslope, terrace, etc.): flat, slight depression Local relief (concave, convex, none): concave Slope (%): 0%  
 Subregion (LRR): A Lat: \_\_\_\_\_ Long: \_\_\_\_\_ Datum: \_\_\_\_\_  
 Soil Map Unit Name: Mixed alluvial land NWI classification: PSS  
 Are climatic / hydrologic conditions on the site typical for this time of year? Yes  No  (If no, explain in Remarks.)  
 Are Vegetation , Soil , or Hydrology , significantly disturbed? Are "Normal Circumstances" present? Yes  No   
 Are Vegetation , Soil , or Hydrology , naturally problematic? (If needed, explain any answers in Remarks.)

### SUMMARY OF FINDINGS – Attach site map showing sampling point locations, transects, important features, etc.

Hydrophytic Vegetation Present?	Yes <input checked="" type="checkbox"/>	No <input type="checkbox"/>	<b>Is the Sampled Area within a Wetland?</b>	Yes <input checked="" type="checkbox"/>	No <input type="checkbox"/>
Hydric Soil Present?	Yes <input checked="" type="checkbox"/>	No <input type="checkbox"/>		Yes <input checked="" type="checkbox"/>	No <input type="checkbox"/>
Wetland Hydrology Present?	Yes <input checked="" type="checkbox"/>	No <input type="checkbox"/>		Yes <input checked="" type="checkbox"/>	No <input type="checkbox"/>
Remarks: Sample plot is located at north end of PSS, approximately 10 feet northwest of trail edge, and approximately 10 feet south of large <i>Salix lucida</i> .					

### VEGETATION – Use scientific names of plants

<u>Tree Stratum</u> (Plot size: <u>30 feet</u> )	Absolute % Cover	Dominant Species?	Indicator Status	<b>Dominance Test Worksheet:</b>																
1. <u><i>Salix lucida</i> (overhanging from upland)</u>	<u>30</u>	<u>n/a*</u>	<u>FACW</u>	Number of Dominant Species That Are OBL, FACW, or FAC: <span style="float: right;"><u>34</u> (A)</span>  Total Number of Dominant Species Across All Strata: <span style="float: right;"><u>4</u> (B)</span>  Percent of Dominant Species That Are OBL, FACW, or FAC: <span style="float: right;"><u>75</u> (A/B)</span>																
2. _____	_____	_____	_____																	
3. _____	_____	_____	_____																	
4. _____	_____	_____	_____																	
50% = <u>15</u> , 20% = <u>6</u>	<u>30</u>	= Total Cover																		
<u>Sapling/Shrub Stratum</u> (Plot size: <u>15 feet</u> )				<b>Prevalence Index worksheet:</b>  <table style="width: 100%; border: none;"> <tr> <td style="text-align: center;">Total % Cover of:</td> <td style="text-align: center;">Multiply by:</td> </tr> <tr> <td>OBL species _____</td> <td>x1 = _____</td> </tr> <tr> <td>FACW species _____</td> <td>x2 = _____</td> </tr> <tr> <td>FAC species _____</td> <td>x3 = _____</td> </tr> <tr> <td>FACU species _____</td> <td>x4 = _____</td> </tr> <tr> <td>UPL species _____</td> <td>x5 = _____</td> </tr> <tr> <td>Column Totals: _____ (A)</td> <td>_____ (B)</td> </tr> <tr> <td colspan="2" style="text-align: center;">Prevalence Index = B/A = _____</td> </tr> </table>	Total % Cover of:	Multiply by:	OBL species _____	x1 = _____	FACW species _____	x2 = _____	FAC species _____	x3 = _____	FACU species _____	x4 = _____	UPL species _____	x5 = _____	Column Totals: _____ (A)	_____ (B)	Prevalence Index = B/A = _____	
Total % Cover of:	Multiply by:																			
OBL species _____	x1 = _____																			
FACW species _____	x2 = _____																			
FAC species _____	x3 = _____																			
FACU species _____	x4 = _____																			
UPL species _____	x5 = _____																			
Column Totals: _____ (A)	_____ (B)																			
Prevalence Index = B/A = _____																				
1. <u><i>Cornus sericea</i></u>	<u>50</u>	<u>yes</u>	<u>FACW</u>																	
2. <u><i>Physocarpus capitatus</i></u>	<u>40</u>	<u>yes</u>	<u>FACW</u>																	
3. _____	_____	_____	_____																	
4. _____	_____	_____	_____																	
5. _____	_____	_____	_____																	
50% = <u>45</u> , 20% = <u>18</u>	<u>90</u>	= Total Cover																		
<u>Herb Stratum</u> (Plot size: <u>3 feet</u> )																				
1. <u><i>Ranunculus repens</i></u>	<u>20</u>	<u>yes</u>	<u>FAC</u>	<b>Hydrophytic Vegetation Indicators:</b> <input type="checkbox"/> 1 – Rapid Test for Hydrophytic Vegetation <input checked="" type="checkbox"/> 2 - Dominance Test is >50% <input type="checkbox"/> 3 - Prevalence Index is ≤3.0 <sup>1</sup> <input type="checkbox"/> 4 - Morphological Adaptations <sup>1</sup> (Provide supporting data in Remarks or on a separate sheet) <input type="checkbox"/> 5 - Wetland Non-Vascular Plants <sup>1</sup> <input type="checkbox"/> Problematic Hydrophytic Vegetation <sup>1</sup> (Explain)  <sup>1</sup> Indicators of hydric soil and wetland hydrology must be present, unless disturbed or problematic.																
2. _____	_____	_____	_____																	
3. _____	_____	_____	_____																	
4. _____	_____	_____	_____																	
5. _____	_____	_____	_____																	
6. _____	_____	_____	_____																	
7. _____	_____	_____	_____																	
8. _____	_____	_____	_____																	
9. _____	_____	_____	_____																	
10. _____	_____	_____	_____																	
11. _____	_____	_____	_____																	
50% = <u>10</u> , 20% = <u>4</u>	<u>20</u>	= Total Cover																		
<u>Woody Vine Stratum</u> (Plot size: <u>15 feet</u> )																				
1. <u><i>Rubus armeniacus</i></u>	<u>5</u>	<u>yes</u>	<u>FACU</u>																	
2. _____	_____	_____	_____																	
50% = <u>2.5</u> , 20% = <u>1</u>	<u>5</u>	= Total Cover																		
% Bare Ground in Herb Stratum <u>80</u>																				
<b>Hydrophytic Vegetation Present?</b> Yes <input checked="" type="checkbox"/> No <input type="checkbox"/>																				

Remarks: \*excluded from calculations per chapter 2 guidance . Species with less than 5% cover are not considered dominant.

**SOIL**

Profile Description: (Describe to the depth needed to document the indicator or confirm the absence of indicators.)								
Depth (inches)	Matrix		Redox Features				Texture	Remarks
	Color (moist)	%	Color (moist)	%	Type <sup>1</sup>	Loc <sup>2</sup>		
0-18	10YR 2/1	100	-	-	-	-	loamy sand	
_____	_____	_____	_____	_____	_____	_____	_____	_____
_____	_____	_____	_____	_____	_____	_____	_____	_____
_____	_____	_____	_____	_____	_____	_____	_____	_____
_____	_____	_____	_____	_____	_____	_____	_____	_____
_____	_____	_____	_____	_____	_____	_____	_____	_____
_____	_____	_____	_____	_____	_____	_____	_____	_____

<sup>1</sup>Type: C= Concentration, D=Depletion, RM=Reduced Matrix, CS=Covered or Coated Sand Grains.      <sup>2</sup>Location: PL=Pore Lining, M=Matrix

Hydric Soil Indicators: (Applicable to all LRRs, unless otherwise noted.)		Indicators for Problematic Hydric Soils <sup>3</sup> :	
<input type="checkbox"/> Histosol (A1)	<input type="checkbox"/> Sandy Redox (S5)	<input type="checkbox"/> 2 cm Muck (A10)	
<input type="checkbox"/> Histic Epipedon (A2)	<input type="checkbox"/> Stripped Matrix (S6)	<input type="checkbox"/> Red Parent Material (TF2)	
<input type="checkbox"/> Black Histic (A3)	<input type="checkbox"/> Loamy Mucky Mineral (F1) (except MLRA 1)	<input type="checkbox"/> Very Shallow Dark Surface (TF12)	
<input type="checkbox"/> Hydrogen Sulfide (A4)	<input type="checkbox"/> Loamy Gleyed Matrix (F2)	<input checked="" type="checkbox"/> Other (Explain in Remarks)	
<input type="checkbox"/> Depleted Below Dark Surface (A11)	<input type="checkbox"/> Depleted Matrix (F3)		
<input type="checkbox"/> Thick Dark Surface (A12)	<input type="checkbox"/> Redox Dark Surface (F6)		
<input type="checkbox"/> Sandy Mucky Mineral (S1)	<input type="checkbox"/> Depleted Dark Surface (F7)		
<input type="checkbox"/> Sandy Gleyed Matrix (S4)	<input type="checkbox"/> Redox Depressions (F8)		

<sup>3</sup>Indicators of hydrophytic vegetation and wetland hydrology must be present, unless disturbed or problematic.

<b>Restrictive Layer (if present):</b> Type: _____ Depth (inches): _____	<b>Hydric Soils Present?</b> Yes <input checked="" type="checkbox"/> No <input type="checkbox"/>
--	--

Remarks:    The presence of hydrophytic vegetation and wetland hydrology, and a dark matrix indicate the hydric soil criterion is satisfied. Meets Dark Surface (S7).

**HYDROLOGY**

Wetland Hydrology Indicators:			
Primary Indicators (minimum of one required; check all that apply)		Secondary Indicators (2 or more required)	
<input type="checkbox"/> Surface Water (A1)	<input type="checkbox"/> Water-Stained Leaves (B9)	<input type="checkbox"/> Water-Stained Leaves (B9)	
<input checked="" type="checkbox"/> High Water Table (A2)	<b>(except MLRA 1, 2, 4A, and 4B)</b>	<b>(MLRA 1, 2, 4A, and 4B)</b>	
<input checked="" type="checkbox"/> Saturation (A3)	<input type="checkbox"/> Salt Crust (B11)	<input type="checkbox"/> Drainage Patterns (B10)	
<input type="checkbox"/> Water Marks (B1)	<input type="checkbox"/> Aquatic Invertebrates (B13)	<input type="checkbox"/> Dry-Season Water Table (C2)	
<input type="checkbox"/> Sediment Deposits (B2)	<input type="checkbox"/> Hydrogen Sulfide Odor (C1)	<input type="checkbox"/> Saturation Visible on Aerial Imagery (C9)	
<input type="checkbox"/> Drift Deposits (B3)	<input type="checkbox"/> Oxidized Rhizospheres along Living Roots (C3)	<input type="checkbox"/> Geomorphic Position (D2)	
<input type="checkbox"/> Algal Mat or Crust (B4)	<input type="checkbox"/> Presence of Reduced Iron (C4)	<input type="checkbox"/> Shallow Aquitard (D3)	
<input type="checkbox"/> Iron Deposits (B5)	<input type="checkbox"/> Recent Iron Reduction in Tilled Soils (C6)	<input type="checkbox"/> FAC-Neutral Test (D5)	
<input type="checkbox"/> Surface Soil Cracks (B6)	<input type="checkbox"/> Stunted or Stresses Plants (D1) (LRR A)	<input type="checkbox"/> Raised Ant Mounds (D6) (LRR A)	
<input type="checkbox"/> Inundation Visible on Aerial Imagery (B7)	<input type="checkbox"/> Other (Explain in Remarks)	<input type="checkbox"/> Frost-Heave Hummocks (D7)	
<input type="checkbox"/> Sparsely Vegetated Concave Surface (B8)			

<b>Field Observations:</b> Surface Water Present?    Yes <input type="checkbox"/> No <input checked="" type="checkbox"/> Depth (inches): _____ Water Table Present?    Yes <input checked="" type="checkbox"/> No <input type="checkbox"/> Depth (inches): <u>8</u> Saturation Present? (includes capillary fringe)    Yes <input checked="" type="checkbox"/> No <input type="checkbox"/> Depth (inches): <u>surface</u>	<b>Wetland Hydrology Present?</b> Yes <input checked="" type="checkbox"/> No <input type="checkbox"/>
--	---

Describe Recorded Data (stream gauge, monitoring well, aerial photos, previous inspections), if available:

Remarks:

**Exhibit 16**  
**SSDP2016-00415**



# WETLAND DETERMINATION DATA FORM – Western Mountains, Valleys, and Coast Region

Project Site: ELST - South Sammamish Segment City/County: Sammamish/King Sampling Date: 03-19-14  
 Applicant/Owner: King County State: WA Sampling Point: W26D-SP1  
 Investigator(s): C. Worsley; K. Seckel Section, Township, Range: S33, T25N, R06E  
 Landform (hillslope, terrace, etc.): flat Local relief (concave, convex, none): none Slope (%): 1%  
 Subregion (LRR): A Lat: \_\_\_\_\_ Long: \_\_\_\_\_ Datum: \_\_\_\_\_  
 Soil Map Unit Name: Mixed alluvial land NWI classification: PEM  
 Are climatic / hydrologic conditions on the site typical for this time of year? Yes  No  (If no, explain in Remarks.)  
 Are Vegetation , Soil , or Hydrology , significantly disturbed? Are "Normal Circumstances" present? Yes  No   
 Are Vegetation , Soil , or Hydrology , naturally problematic? (If needed, explain any answers in Remarks.)

## SUMMARY OF FINDINGS – Attach site map showing sampling point locations, transects, important features, etc.

Hydrophytic Vegetation Present?	Yes <input checked="" type="checkbox"/>	No <input type="checkbox"/>	<b>Is the Sampled Area within a Wetland?</b>	Yes <input checked="" type="checkbox"/>	No <input type="checkbox"/>
Hydric Soil Present?	Yes <input checked="" type="checkbox"/>	No <input type="checkbox"/>		Yes <input checked="" type="checkbox"/>	No <input type="checkbox"/>
Wetland Hydrology Present?	Yes <input checked="" type="checkbox"/>	No <input type="checkbox"/>		Yes <input checked="" type="checkbox"/>	No <input type="checkbox"/>
Remarks: Sample plot is located at southeast corner of wetland, on northwest side of stream in bend. Approximately 8 feet west of clump of Alnus rubra (5 trunks) growing in adjacent upland. This wetland is a mitigation restoration site with plantings, LWD, and irrigation.					

## VEGETATION – Use scientific names of plants

Tree Stratum (Plot size: <u>30 feet</u> )	Absolute % Cover	Dominant Species?	Indicator Status	Dominance Test Worksheet:
1. <u>Alnus rubra (overhanging from upland)</u>	<u>50</u>	<u>n/a*</u>	<u>FAC</u>	Number of Dominant Species That Are OBL, FACW, or FAC: <u>1</u> (A)
2. _____	_____	_____	_____	Total Number of Dominant Species Across All Strata: <u>1</u> (B)
3. _____	_____	_____	_____	Percent of Dominant Species That Are OBL, FACW, or FAC: <u>100</u> (A/B)
4. _____	_____	_____	_____	
50% = _____, 20% = _____	_____	= Total Cover		
Sapling/Shrub Stratum (Plot size: <u>15 feet</u> )				Prevalence Index worksheet:
1. _____	_____	_____	_____	Total % Cover of: _____ Multiply by:
2. _____	_____	_____	_____	OBL species _____ x1 = _____
3. _____	_____	_____	_____	FACW species _____ x2 = _____
4. _____	_____	_____	_____	FAC species _____ x3 = _____
5. _____	_____	_____	_____	FACU species _____ x4 = _____
50% = _____, 20% = _____	_____	= Total Cover		UPL species _____ x5 = _____
Herb Stratum (Plot size: <u>3 feet</u> )				Column Totals: _____ (A) _____ (B)
1. <u>Eleocharis obtusa</u>	<u>30</u>	<u>yes</u>	<u>OBL</u>	Prevalence Index = B/A = _____
2. <u>Scirpus microcarpus</u>	<u>10</u>	<u>no</u>	<u>OBL</u>	
3. <u>Phalaris arundinacea</u>	<u>2</u>	<u>no</u>	<u>FACW</u>	
4. <u>Nasturium officinale</u>	<u>5</u>	<u>no</u>	<u>OBL</u>	
5. <u>Veronica americana</u>	<u>10</u>	<u>no</u>	<u>OBL</u>	
6. _____	_____	_____	_____	
7. _____	_____	_____	_____	
8. _____	_____	_____	_____	
9. _____	_____	_____	_____	
10. _____	_____	_____	_____	
11. _____	_____	_____	_____	
50% = <u>28.5</u> , 20% = <u>11.4</u>	<u>57</u>	= Total Cover		
Woody Vine Stratum (Plot size: <u>15 feet</u> )				Hydrophytic Vegetation Indicators:
1. _____	_____	_____	_____	<input type="checkbox"/> 1 – Rapid Test for Hydrophytic Vegetation
2. _____	_____	_____	_____	<input checked="" type="checkbox"/> 2 - Dominance Test is >50%
50% = _____, 20% = _____	_____	= Total Cover		<input type="checkbox"/> 3 - Prevalence Index is ≤3.0 <sup>1</sup>
% Bare Ground in Herb Stratum <u>50</u>				<input type="checkbox"/> 4 - Morphological Adaptations <sup>1</sup> (Provide supporting data in Remarks or on a separate sheet)
Remarks: *excluded from calculations per chapter 2 guidance .				<input type="checkbox"/> 5 - Wetland Non-Vascular Plants <sup>1</sup>
				<input type="checkbox"/> Problematic Hydrophytic Vegetation <sup>1</sup> (Explain)
				<sup>1</sup> Indicators of hydric soil and wetland hydrology must be present, unless disturbed or problematic.
				<b>Hydrophytic Vegetation Present?</b> Yes <input checked="" type="checkbox"/> No <input type="checkbox"/>

Remarks: \*excluded from calculations per chapter 2 guidance .

**SOIL**

**Profile Description: (Describe to the depth needed to document the indicator or confirm the absence of indicators.)**

Depth (inches)	Matrix		Redox Features				Texture	Remarks
	Color (moist)	%	Color (moist)	%	Type <sup>1</sup>	Loc <sup>2</sup>		
0-6	<u>10YR 2/1</u>	<u>100</u>	-	-	-	-	<u>si. loam</u>	<u>high organic content</u>
6-17	<u>2.5Y 6/2</u>	<u>95</u>	<u>7.5YR 5/8</u>	<u>5</u>	<u>C</u>	<u>M</u>	<u>lo. sand</u>	
_____	_____	_____	_____	_____	_____	_____	_____	_____
_____	_____	_____	_____	_____	_____	_____	_____	_____
_____	_____	_____	_____	_____	_____	_____	_____	_____
_____	_____	_____	_____	_____	_____	_____	_____	_____

<sup>1</sup>Type: C= Concentration, D=Depletion, RM=Reduced Matrix, CS=Covered or Coated Sand Grains. <sup>2</sup>Location: PL=Pore Lining, M=Matrix

**Hydric Soil Indicators: (Applicable to all LRRs, unless otherwise noted.)**

- Histosol (A1)
- Histic Epipedon (A2)
- Black Histic (A3)
- Hydrogen Sulfide (A4)
- Depleted Below Dark Surface (A11)
- Thick Dark Surface (A12)
- Sandy Mucky Mineral (S1)
- Sandy Gleyed Matrix (S4)
- Sandy Redox (S5)
- Stripped Matrix (S6)
- Loamy Mucky Mineral (F1) **(except MLRA 1)**
- Loamy Gleyed Matrix (F2)
- Depleted Matrix (F3)
- Redox Dark Surface (F6)
- Depleted Dark Surface (F7)
- Redox Depressions (F8)

**Indicators for Problematic Hydric Soils<sup>3</sup>:**

- 2 cm Muck (A10)
- Red Parent Material (TF2)
- Very Shallow Dark Surface (TF12)
- Other (Explain in Remarks)

<sup>3</sup>Indicators of hydrophytic vegetation and wetland hydrology must be present, unless disturbed or problematic.

**Restrictive Layer (if present):**

Type: \_\_\_\_\_  
 Depth (inches): \_\_\_\_\_

**Hydric Soils Present?** Yes  No

Remarks:

**HYDROLOGY**

**Wetland Hydrology Indicators:**

Primary Indicators (minimum of one required; check all that apply)

- Surface Water (A1)
- High Water Table (A2)
- Saturation (A3)
- Water Marks (B1)
- Sediment Deposits (B2)
- Drift Deposits (B3)
- Algal Mat or Crust (B4)
- Iron Deposits (B5)
- Surface Soil Cracks (B6)
- Inundation Visible on Aerial Imagery (B7)
- Sparsely Vegetated Concave Surface (B8)
- Water-Stained Leaves (B9) **(except MLRA 1, 2, 4A, and 4B)**
- Salt Crust (B11)
- Aquatic Invertebrates (B13)
- Hydrogen Sulfide Odor (C1)
- Oxidized Rhizospheres along Living Roots (C3)
- Presence of Reduced Iron (C4)
- Recent Iron Reduction in Tilled Soils (C6)
- Stunted or Stresses Plants (D1) **(LRR A)**
- Other (Explain in Remarks)

Secondary Indicators (2 or more required)

- Water-Stained Leaves (B9) **(MLRA 1, 2, 4A, and 4B)**
- Drainage Patterns (B10)
- Dry-Season Water Table (C2)
- Saturation Visible on Aerial Imagery (C9)
- Geomorphic Position (D2)
- Shallow Aquitard (D3)
- FAC-Neutral Test (D5)
- Raised Ant Mounds (D6) **(LRR A)**
- Frost-Heave Hummocks (D7)

**Field Observations:**

Surface Water Present? Yes  No  Depth (inches): \_\_\_\_\_  
 Water Table Present? Yes  No  Depth (inches): surface  
 Saturation Present? (includes capillary fringe) Yes  No  Depth (inches): surface

**Wetland Hydrology Present?** Yes  No

Describe Recorded Data (stream gauge, monitoring well, aerial photos, previous inspections), if available:

Remarks: Inundation in adjacent microdepressions. Flowing water observed in adjacent stream.

**Exhibit 16**  
**SSDP2016-00415**

Data Plot #: 28A-SP1  
 Wetland: 28A

## WETLAND DETERMINATION (Modified from: 1987 ACOE Wetlands Delineation Manual)

Project/Site: ELST Re-delineation Date: 11/13/2007 Revisited 09-27-13  
 Applicant/Owner: King County County: King  
 Investigator: Chip Maney, Erik Christensen State: WA  
 1987 Method  1977 WA St. Method Community ID: PFO  
 Do Normal Circumstances exist on the site? Yes X No \_\_\_\_\_ Field Plot ID: 28A-SP1  
 Is the site significantly disturbed (Atypical Situation)? Yes \_\_\_\_\_ No X  
 Is the area a potential Problem Area? Yes \_\_\_\_\_ No X

**Remarks** (Explain sample location, disturbances, problem areas):  
*This sample plot is located approximately 10 feet south of Flag 28A-11.*

### VEGETATION (✓ Dominant species are checked)

Plant Species	% Cover	Stratum	Indicator
✓ 1. <u>Equisetum telmateia</u>	<u>50</u>	<u>Herb</u>	<u>FACW</u>
✓ 2. <u>Rubus armeniacus</u>	<u>50</u>	<u>Shrub</u>	<u>FACU</u>
3. <u>Rubus parviflorus</u>	<u>5</u>	<u>Shrub</u>	<u>FAC-</u>
✓ 4. <u>Alnus rubra</u>	<u>60</u>	<u>Tree</u>	<u>FAC</u>

### 09-27-13 Observations

Equisetum telmateia 50%  
 Rubus armeniacus 50%  
 Alnus rubra 60%

Percent of **Dominant Species** that are OBL, FACW, or FAC (except FAC-). Include species noted (\*) as showing morphological adaptations to wetlands. "T" indicates trace. 67

**Remarks** (Describe disturbances, relevant local variations, seasonal effects, etc.):  
*The percent of dominant species that are hydrophytic is greater than 50 percent. Hydrophytic vegetation criterion is satisfied.*

### HYDROLOGY

#### Recorded Data (Describe in Remarks):

\_\_\_\_\_ Stream, Lake, or Tide Gage  
 \_\_\_\_\_ Aerial Photograph  
 \_\_\_\_\_ Other  
X No Recorded Data Available

#### Wetland Hydrology Indicators (Describe in Remarks):

Primary Indicators:  
 \_\_\_\_\_ Inundated  
X Saturated in Upper 12 inches  
 \_\_\_\_\_ Water Marks  
 \_\_\_\_\_ Drift Lines  
 \_\_\_\_\_ Sediment Deposits  
 \_\_\_\_\_ Drainage Patterns in Wetlands

#### Field Observations:

Depth of Surface Water: none (in.)  
 Depth to Free Water in Pit: 10 (in.)  
 Depth to Saturated Soil: 5 (in.)

Secondary Indicators (2 or more required):  
 \_\_\_\_\_ Oxidized Rhizospheres in Upper 12 inches  
 \_\_\_\_\_ Water-Stained Leaves  
 \_\_\_\_\_ Local Soil Survey Data  
 \_\_\_\_\_ Other (Explain in Remarks)

**Remarks** (As relevant, describe recent precipitation, hydrologic modifications, local variations, etc.):  
*Saturation in the upper 12 inches satisfies wetland hydrology criterion.*

# Parametrix

Data Plot #: 28A-SP1  
Wetland: 28A

Project/Site: ELST Re-delineation Date: 11/13/2007 Revisited 09-27-13

## SOIL

### Soil Survey Data:

Map Unit Name: Alderwood and Kitsap Soils Drainage Class: Various  
Field Observations Confirm Mapped Type?  
Taxonomy (Subgroup): N/A Yes  No  NA

### Profile Description:

Depth (Inches)	Horizon Designation	Matrix Color (Munsell Moist)	Mottle Color (Munsell Moist)	Mottle Abundance/Contrast	Texture, Concretions, Rhizospheres, etc.
0-10	A	10YR 3/1	none	none	loam
10-12	B1	10YR 3/1	none	none	loamy sand
12-18	B2	10YR 2/1	none	none	sandy loam

### Hydric Soil Indicators:

- |   |   |
|---|---|
| <input type="checkbox"/> Histosol                               | <input type="checkbox"/> Listed on Hydric Soils List      |
| <input type="checkbox"/> Histic Epipedon                        | <input type="checkbox"/> Fe/Mn Concretions                |
| <input type="checkbox"/> Sulfidic Odor                          | <input type="checkbox"/> Organic Streaking in Sandy Soils |
| <input type="checkbox"/> Aquic or Peraguic Moisture Regime      | <input type="checkbox"/> Mottles (Redoximorphic Features) |
| <input type="checkbox"/> Reducing Conditions                    | <input type="checkbox"/> Other (Explain in Remarks)       |
| <input checked="" type="checkbox"/> Gleyed or Low-Chroma Colors |   |
| <input type="checkbox"/> High Organic Content in Surface Layer  |   |

Remarks (Describe soil disturbances, local variations, etc.):  
*Low soil matrix colors indicate hydric soils.*

## WETLAND DETERMINATION

Hydrophytic Vegetation Present? Yes  No  Is this Sampling Point Within a Wetland?  
Hydric Soils Present? Yes  No  Yes  No   
Wetland Hydrology Present? Yes  No

### Remarks

*Wetland vegetation, hydrology, and soil criteria are met. Therefore, the sample plot is located in a wetland.*

Data Plot #: 28A-SP2  
 Wetland: Upland near 28A

## WETLAND DETERMINATION (Modified from: 1987 ACOE Wetlands Delineation Manual)

Project/Site: ELST Re-delineation Date: 11/13/2007 Revisited 09-27-13  
 Applicant/Owner: King County County: King  
 Investigator: Chip Maney, Erik Christensen State: WA  
 1987 Method  1997 WA St. Method Community ID: Upland Forest  
 Do Normal Circumstances exist on the site? Yes X No \_\_\_\_\_ Field Plot ID: 28A-SP2  
 Is the site significantly disturbed (Atypical Situation)? Yes \_\_\_\_\_ No X  
 Is the area a potential Problem Area? Yes \_\_\_\_\_ No X

**Remarks** (Explain sample location, disturbances, problem areas):  
*This sample plot is located approximately 7 feet east of Flag 28A-11.*

### VEGETATION (✓ Dominant species are checked)

Plant Species	% Cover	Stratum	Indicator
1. <u>Equisetum telmateia</u>	<u>trace</u>	<u>Herb</u>	<u>FACW</u>
✓ 2. <u>Polystichum munitum</u>	<u>60</u>	<u>Herb</u>	<u>FACU</u>
✓ 3. <u>Rubus armeniacus</u>	<u>90</u>	<u>Shrub</u>	<u>FACU</u>
✓ 4. <u>Alnus rubra</u>	<u>70</u>	<u>Tree</u>	<u>FAC</u>

### 09-27-13 Observations

Equisetum telmateia trace  
 Rubus armeniacus 90%  
 Alnus rubra 70%  
 Acer macrophyllum 25%

Percent of **Dominant Species** that are OBL, FACW, or FAC (except FAC-). Include species noted (\*) as showing morphological adaptations to wetlands. "T" indicates trace. 33

**Remarks** (Describe disturbances, relevant local variations, seasonal effects, etc.):  
*The percent of dominant species that are hydrophytic is not greater than 50 percent. Hydrophytic vegetation criterion is not satisfied.*

### HYDROLOGY

#### Recorded Data (Describe in Remarks):

\_\_\_\_\_ Stream, Lake, or Tide Gage  
 \_\_\_\_\_ Aerial Photograph  
 \_\_\_\_\_ Other  
X No Recorded Data Available

#### Wetland Hydrology Indicators (Describe in Remarks):

Primary Indicators:  
 \_\_\_\_\_ Inundated  
 \_\_\_\_\_ Saturated in Upper 12 inches  
 \_\_\_\_\_ Water Marks  
 \_\_\_\_\_ Drift Lines  
 \_\_\_\_\_ Sediment Deposits  
 \_\_\_\_\_ Drainage Patterns in Wetlands

#### Field Observations:

Depth of Surface Water: none (in.)  
 Depth to Free Water in Pit: none (in.)  
 Depth to Saturated Soil: none (in.)

Secondary Indicators (2 or more required):  
 \_\_\_\_\_ Oxidized Rhizospheres in Upper 12 inches  
 \_\_\_\_\_ Water-Stained Leaves  
 \_\_\_\_\_ Local Soil Survey Data  
 \_\_\_\_\_ Other (Explain in Remarks)

**Remarks** (As relevant, describe recent precipitation, hydrologic modifications, local variations, etc.):  
*No primary or secondary indicators of hydrology are present. Wetland hydrology criterion is not satisfied.*

# Parametrix

Data Plot #: 28A-SP2  
Wetland: Upland near 28A

Project/Site: ELST Re-delineation Date: 11/13/2007 Revisited 09-27-13

## SOIL

### Soil Survey Data:

Map Unit Name: Alderwood and Kitsap Soils Drainage Class: Varies  
Field Observations Confirm Mapped Type?  
Taxonomy (Subgroup): N/A Yes  No  NA

### Profile Description:

Depth (Inches)	Horizon Designation	Matrix Color (Munsell Moist)	Mottle Color (Munsell Moist)	Mottle Abundance/Contrast	Texture, Concretions, Rhizospheres, etc.
0-12	A	10YR 3/2	none	none	loam
12-18	B	10YR 4/2	10YR 4/6	few, fine	silt loam

### Hydric Soil Indicators:

- |  |   |
|--|---|
| <input type="checkbox"/> Histosol                              | <input type="checkbox"/> Listed on Hydric Soils List      |
| <input type="checkbox"/> Histic Epipedon                       | <input type="checkbox"/> Fe/Mn Concretions                |
| <input type="checkbox"/> Sulfidic Odor                         | <input type="checkbox"/> Organic Streaking in Sandy Soils |
| <input type="checkbox"/> Aquic or Peraguc Moisture Regime      | <input type="checkbox"/> Mottles (Redoximorphic Features) |
| <input type="checkbox"/> Reducing Conditions                   | <input type="checkbox"/> Other (Explain in Remarks)       |
| <input type="checkbox"/> Gleyed or Low-Chroma Colors           |   |
| <input type="checkbox"/> High Organic Content in Surface Layer |   |

Remarks (Describe soil disturbances, local variations, etc.):  
*No hydric soil indicators are present. Hydric soil criterion is not satisfied.*

## WETLAND DETERMINATION

Hydrophytic Vegetation Present? Yes  No  Is this Sampling Point Within a Wetland?  
Hydric Soils Present? Yes  No  Yes  No   
Wetland Hydrology Present? Yes  No

Remarks  
*None of the wetland criteria are met. Therefore, the sample plot is not located in a wetland.*

# Parametrix

Data Plot #: 28B-SP1  
Wetland: 28B

## WETLAND DETERMINATION (Modified from: 1987 ACOE Wetlands Delineation Manual)

Project/Site: ELST Re-delineation Date: 11/9/2007 Revisited 09-27-13  
Applicant/Owner: King County County: King  
Investigator: Chip Maney, Erik Christensen State: WA  
 1987 Method  1997 WA St. Method Community ID: PSS  
Do Normal Circumstances exist on the site? Yes X No      Field Plot ID: 28B-SP1  
Is the site significantly disturbed (Atypical Situation)? Yes      No X  
Is the area a potential Problem Area? Yes      No X

**Remarks** (Explain sample location, disturbances, problem areas):

*This sample plot is located in the center of the wetland approximately 15 feet upslope.*

### VEGETATION (✓ Dominant species are checked)

Plant Species	% Cover	Stratum	Indicator
✓ 1. <u>Phalaris arundinacea</u>	<u>20</u>	<u>Herb</u>	<u>FACW</u>
2. <u>Rosa pisocarpa</u>	<u>10</u>	<u>Shrub</u>	<u>FAC</u>
✓ 3. <u>Rubus armeniacus</u>	<u>40</u>	<u>Shrub</u>	<u>FACU</u>
✓ 4. <u>Spiraea douglasii</u>	<u>40</u>	<u>Shrub</u>	<u>FACW</u>

Percent of **Dominant Species** that are OBL, FACW, or FAC (except FAC-). Include species noted (\*) as showing morphological adaptations to wetlands. "T" indicates trace. 67

**Remarks** (Describe disturbances, relevant local variations, seasonal effects, etc.):

*The percent of dominant species that are hydrophytic is greater than 50 percent. Hydrophytic vegetation criterion is satisfied.*

### HYDROLOGY

**Recorded Data** (Describe in Remarks):

     Stream, Lake, or Tide Gage  
     Aerial Photograph  
     Other  
  X   No Recorded Data Available

**Field Observations:**

Depth of Surface Water: none (in.)  
Depth to Free Water in Pit: none (in.)  
Depth to Saturated Soil: 4 (in.)

**Wetland Hydrology Indicators** (Describe in Remarks):

Primary Indicators:

     Inundated  
  X   Saturated in Upper 12 inches  
     Water Marks  
     Drift Lines  
     Sediment Deposits  
     Drainage Patterns in Wetlands

Secondary Indicators (2 or more required):

     Oxidized Rhizospheres in Upper 12 inches  
     Water-Stained Leaves  
     Local Soil Survey Data  
     Other (Explain in Remarks)

**Remarks** (As relevant, describe recent precipitation, hydrologic modifications, local variations, etc.):

*Saturation in the upper 12 inches satisfies wetland hydrology criterion.*

# Parametrix

Data Plot #: 28B-SP1  
Wetland: 28B

Project/Site: ELST Re-delineation Date: 11/9/2007 Revisited 09-27-13

## SOIL

### Soil Survey Data:

Map Unit Name: Mixed Alluvial Land Drainage Class: Well drained to very poorly drained  
Field Observations Confirm Mapped Type?

Taxonomy (Subgroup): N/A Yes  No  NA

### Profile Description:

Depth (Inches)	Horizon Designation	Matrix Color (Munsell Moist)	Mottle Color (Munsell Moist)	Mottle Abundance/Contrast	Texture, Concretions, Rhizospheres, etc.
0-12	A	10YR 3/1	none	none	silt loam
12-18	B	10YR 3/1	2.5YR 4/6	coarse, common	silt loam

### Hydric Soil Indicators:

- Histosol
- Histic Epipedon
- Sulfidic Odor
- Aquic or Peraguc Moisture Regime
- Reducing Conditions
- Gleyed or Low-Chroma Colors
- High Organic Content in Surface Layer
- Listed on Hydric Soils List
- Fe/Mn Concretions
- Organic Streaking in Sandy Soils
- Mottles (Redoximorphic Features)
- Other (Explain in Remarks)

Remarks (Describe soil disturbances, local variations, etc.):  
*Soils are disturbed. Trash and roof shingles are present and are the source of the mottles. Low chroma indicates hydric soil.*

## WETLAND DETERMINATION

Hydrophytic Vegetation Present? Yes  No  Is this Sampling Point Within a Wetland?  
Hydric Soils Present? Yes  No  Yes  No   
Wetland Hydrology Present? Yes  No

Remarks  
*Wetland vegetation, hydrology, and soil criteria are met. Therefore, the sample plot is located in a wetland.*



# Parametrix

Data Plot #: 28B-SP2  
Wetland: Upland near 28B

## WETLAND DETERMINATION (Modified from: 1987 ACOE Wetlands Delineation Manual)

Project/Site: ELST Re-delineation Date: 11/9/2007  
Applicant/Owner: King County County: King  
Investigator: Chip Maney, Erik Christensen State: WA

1987 Method  1997 WA St. Method Community ID: Upland Shrub  
Do Normal Circumstances exist on the site? Yes X No        Field Plot ID: 28B-SP2  
Is the site significantly disturbed (Atypical Situation)? Yes        No X  
Is the area a potential Problem Area? Yes        No X

Remarks (Explain sample location, disturbances, problem areas):

### VEGETATION (✓ Dominant species are checked)

	Plant Species	% Cover	Stratum	Indicator
1.	<u>Equisetum telmateia</u>	<u>5</u>	<u>Herb</u>	<u>FACW</u>
2.	<u>Phalaris arundinacea</u>	<u>10</u>	<u>Herb</u>	<u>FACW</u>
✓ 3.	<u>Rubus armeniacus</u>	<u>90</u>	<u>Shrub</u>	<u>FACU</u>
✓ 4.	<u>Acer macrophyllum</u>	<u>50</u>	<u>Tree</u>	<u>FACU</u>

Percent of **Dominant Species** that are OBL, FACW, or FAC (except FAC-). Include species noted (\*) as showing morphological adaptations to wetlands. "T" indicates trace. 0

Remarks (Describe disturbances, relevant local variations, seasonal effects, etc.):

*The percent of dominant species that are hydrophytic is not greater than 50 percent. Hydrophytic vegetation criterion is not satisfied.*

### HYDROLOGY

Recorded Data (Describe in Remarks):

       Stream, Lake, or Tide Gage  
       Aerial Photograph  
       Other  
X No Recorded Data Available

Field Observations:

Depth of Surface Water: none (in.)  
Depth to Free Water in Pit: none (in.)  
Depth to Saturated Soil: none (in.)

Wetland Hydrology Indicators (Describe in Remarks):

Primary Indicators:

       Inundated  
       Saturated in Upper 12 inches  
       Water Marks  
       Drift Lines  
       Sediment Deposits  
       Drainage Patterns in Wetlands

Secondary Indicators (2 or more required):

       Oxidized Rhizospheres in Upper 12 inches  
       Water-Stained Leaves  
       Local Soil Survey Data  
       Other (Explain in Remarks)

Remarks (As relevant, describe recent precipitation, hydrologic modifications, local variations, etc.):

*No primary or secondary indicators of hydrology are present. Wetland hydrology criterion is not satisfied.*

# Parametrix

Data Plot #: 28B-SP2  
Wetland: Upland near 28B

Project/Site: ELST Re-delineation Date: 11/9/2007

## SOIL

### Soil Survey Data:

Map Unit Name: Alderwood gravelly sandy loam 15 to 30% slopes Drainage Class: Moderately well drained  
Field Observations Confirm Mapped Type?

Taxonomy (Subgroup): Entic Durochrepts Yes  No  NA

### Profile Description:

Depth (Inches)	Horizon Designation	Matrix Color (Munsell Moist)	Mottle Color (Munsell Moist)	Mottle Abundance/Contrast	Texture, Concretions, Rhizospheres, etc.
0-15	A	10YR 3/2	none	none	loam

### Hydric Soil Indicators:

- |  |   |
|--|---|
| <input type="checkbox"/> Histosol                              | <input type="checkbox"/> Listed on Hydric Soils List      |
| <input type="checkbox"/> Histic Epipedon                       | <input type="checkbox"/> Fe/Mn Concretions                |
| <input type="checkbox"/> Sulfidic Odor                         | <input type="checkbox"/> Organic Streaking in Sandy Soils |
| <input type="checkbox"/> Aquic or Peraguc Moisture Regime      | <input type="checkbox"/> Mottles (Redoximorphic Features) |
| <input type="checkbox"/> Reducing Conditions                   | <input type="checkbox"/> Other (Explain in Remarks)       |
| <input type="checkbox"/> Gleyed or Low-Chroma Colors           |   |
| <input type="checkbox"/> High Organic Content in Surface Layer |   |

Remarks (Describe soil disturbances, local variations, etc.):  
*No hydric soil indicators are present. Hydric soil criterion is not satisfied.*

## WETLAND DETERMINATION

Hydrophytic Vegetation Present? Yes  No  Is this Sampling Point Within a Wetland?  
Hydric Soils Present? Yes  No  Yes  No   
Wetland Hydrology Present? Yes  No

### Remarks

*Hydrophytic vegetation, hydric soil, and wetland hydrology criteria are not satisfied. Therefore, the sample plot is not located in a wetland.*

Exhibit 16  
SSDP2016-00415  
000933

# Parametrix

Data Plot #: 28C-SP1  
Wetland: 28C

## WETLAND DETERMINATION (Modified from: 1987 ACOE Wetlands Delineation Manual)

Project/Site: ELST Re-delineation Date: 11/13/2007 Revisited 09-27-13  
Applicant/Owner: King County County: King  
Investigator: Chip Maney State: WA  
 1987 Method  1997 WA St. Method Community ID: PEM  
Do Normal Circumstances exist on the site? Yes X No \_\_\_\_\_ Field Plot ID: 28C-SP1  
Is the site significantly disturbed (Atypical Situation)? Yes \_\_\_\_\_ No X  
Is the area a potential Problem Area? Yes \_\_\_\_\_ No X

**Remarks** (Explain sample location, disturbances, problem areas):

*This sample plot is located 15 feet from the north edge of the wetland, less than half way up the eastern slope of the wetland, on the northern edge of the wetland bounded by a small shed and on the eastern edge by a driveway/parking area. No suitable location for an upland plot was available for this wetland.*

### VEGETATION (✓ Dominant species are checked)

Plant Species	% Cover	Stratum	Indicator
✓ 1. <u>Unkown ornamental</u>	<u>25</u>		
✓ 2. <u>Athyrium filix-femina</u>	<u>40</u>	<u>Herb</u>	<u>FAC</u>
✓ 3. <u>Cardamine oligosperma</u>	<u>30</u>	<u>Herb</u>	<u>FAC</u>
✓ 4. <u>Equisetum telmateia</u>	<u>20</u>	<u>Herb</u>	<u>FACW</u>
5. <u>Rubus armeniacus</u>	<u>5</u>	<u>Shrub</u>	<u>FACU</u>
6. <u>Sorbus aucuparia</u>	<u>10</u>	<u>Tree</u>	<u>NL</u>

Percent of **Dominant Species** that are OBL, FACW, or FAC (except FAC-). Include species noted (\*) as showing morphological adaptations to wetlands. "T" indicates trace. 100

**Remarks** (Describe disturbances, relevant local variations, seasonal effects, etc.):

*The percent of dominant species that are hydrophytic is greater than 50 percent. Hydrophytic vegetation criterion is satisfied.*

### HYDROLOGY

**Recorded Data** (Describe in Remarks):

\_\_\_\_\_ Stream, Lake, or Tide Gage  
\_\_\_\_\_ Aerial Photograph  
\_\_\_\_\_ Other  
X No Recorded Data Available

**Field Observations:**

Depth of Surface Water: none (in.)  
Depth to Free Water in Pit: 9 (in.)  
Depth to Saturated Soil: surface (in.)

**Wetland Hydrology Indicators** (Describe in Remarks):

Primary Indicators:

\_\_\_\_\_ Inundated  
X Saturated in Upper 12 inches  
\_\_\_\_\_ Water Marks  
\_\_\_\_\_ Drift Lines  
\_\_\_\_\_ Sediment Deposits  
\_\_\_\_\_ Drainage Patterns in Wetlands

Secondary Indicators (2 or more required):

\_\_\_\_\_ Oxidized Rhizospheres in Upper 12 inches  
\_\_\_\_\_ Water-Stained Leaves  
\_\_\_\_\_ Local Soil Survey Data  
\_\_\_\_\_ Other (Explain in Remarks)

**Remarks** (As relevant, describe recent precipitation, hydrologic modifications, local variations, etc.):

*Saturation in the upper 12 inches satisfies wetland hydrology criterion.*

**Exhibit 16**  
**SSDP2016-00415**  
**000934**

# Parametrix

Data Plot #: 28C-SP1  
Wetland: 28C

Project/Site: ELST Re-delineation Date: 11/13/2007 Revisited 09-27-13

## SOIL

### Soil Survey Data:

Map Unit Name: Mixed Alluvial Land Drainage Class: Well drained to very poorly drained  
Field Observations Confirm Mapped Type?

Taxonomy (Subgroup): N/A Yes  No  NA

### Profile Description:

Depth (Inches)	Horizon Designation	Matrix Color (Munsell Moist)	Mottle Color (Munsell Moist)	Mottle Abundance/Contrast	Texture, Concretions, Rhizospheres, etc.
0-12	A	10YR 3/1	none	none	silt loam
12-18	A2	10YR 3/1	none	none	gravelly loam

### Hydric Soil Indicators:

- |   |   |
|---|---|
| <input type="checkbox"/> Histosol                               | <input type="checkbox"/> Listed on Hydric Soils List      |
| <input type="checkbox"/> Histic Epipedon                        | <input type="checkbox"/> Fe/Mn Concretions                |
| <input type="checkbox"/> Sulfidic Odor                          | <input type="checkbox"/> Organic Streaking in Sandy Soils |
| <input type="checkbox"/> Aquic or Peraguc Moisture Regime       | <input type="checkbox"/> Mottles (Redoximorphic Features) |
| <input type="checkbox"/> Reducing Conditions                    | <input type="checkbox"/> Other (Explain in Remarks)       |
| <input checked="" type="checkbox"/> Gleyed or Low-Chroma Colors |   |
| <input type="checkbox"/> High Organic Content in Surface Layer  |   |

Remarks (Describe soil disturbances, local variations, etc.):  
*Low chroma soil matrix indicates hydric soils. Hydric soil criterion is satisfied.*

## WETLAND DETERMINATION

Hydrophytic Vegetation Present? Yes  No  Is this Sampling Point Within a Wetland?  
Hydric Soils Present? Yes  No  Yes  No   
Wetland Hydrology Present? Yes  No

### Remarks

*Wetland vegetation, hydrology, and soil criteria are met. Therefore, the sample plot is located in a wetland.*

Data Plot #: 28D-SP1  
 Wetland: 28D

## WETLAND DETERMINATION (Modified from: 1987 ACOE Wetlands Delineation Manual)

Project/Site: ELST Re-delineation Date: 11/13/2007 Revised 09-27-13  
 Applicant/Owner: King County County: King  
 Investigator: Chipper Maney, Erik Christensen State: WA  
 1987 Method  1977 WA St. Method Community ID: PSS  
 Do Normal Circumstances exist on the site? Yes X No \_\_\_\_\_ Field Plot ID: 28D-SP1  
 Is the site significantly disturbed (Atypical Situation)? Yes \_\_\_\_\_ No X  
 Is the area a potential Problem Area? Yes \_\_\_\_\_ No X

**Remarks** (Explain sample location, disturbances, problem areas):

*Two wetlands were named 28B. This sample plot has been changed from 28B to 28D to avoid wetland name duplication. This wetland is located at station 452+00. The sample plot is located in the middle of the wetland. This sample plot is located approximately 8 feet south east of Flag 28D-1.*

**VEGETATION** (✓ Dominant species are checked)

Plant Species	% Cover	Stratum	Indicator
1. <u>Convolvulus arvensis</u>	<u>10</u>	<u>Herb</u>	<u>NL</u>
2. <u>Epilobium ciliatum</u>	<u>15</u>	<u>Herb</u>	<u>FACW-</u>
✓ 3. <u>Equisetum telmateia</u>	<u>20</u>	<u>Herb</u>	<u>FACW</u>
✓ 4. <u>Rubus armeniacus</u>	<u>40</u>	<u>Shrub</u>	<u>FACU</u>

**09-27-13 Observations**  
 Convolvulus arvensis 30%  
 Epilobium ciliatum 15%  
 Equisetum telmateia 20%  
 Rubus armeniacus 20%  
 Phalaris arundinacea 40%

Percent of **Dominant Species** that are OBL, FACW, or FAC (except FAC-). Include species noted (\*) as showing morphological adaptations to wetlands. "T" indicates trace. 100

**Remarks** (Describe disturbances, relevant local variations, seasonal effects, etc.):

*Although Rubus armeniacus has an indicator of FACU, it often grows hydrophytically. Rubus armeniacus is believed to be growing hydrophytically in this sample plot because saturation occurs in the upper 12 inches.*

### HYDROLOGY

**Recorded Data** (Describe in Remarks):

\_\_\_\_ Stream, Lake, or Tide Gage  
 \_\_\_\_ Aerial Photograph  
 \_\_\_\_ Other  
X No Recorded Data Available

**Wetland Hydrology Indicators** (Describe in Remarks):

Primary Indicators:  
 \_\_\_\_\_ Inundated  
X Saturated in Upper 12 inches  
 \_\_\_\_\_ Water Marks  
 \_\_\_\_\_ Drift Lines  
 \_\_\_\_\_ Sediment Deposits  
 \_\_\_\_\_ Drainage Patterns in Wetlands

**Field Observations:**

Depth of Surface Water: none (in.)  
 Depth to Free Water in Pit: none (in.)  
 Depth to Saturated Soil: surface (in.)

Secondary Indicators (2 or more required):  
 \_\_\_\_\_ Oxidized Rhizospheres in Upper 12 inches  
 \_\_\_\_\_ Water-Stained Leaves  
 \_\_\_\_\_ Local Soil Survey Data  
 \_\_\_\_\_ Other (Explain in Remarks)

**Remarks** (As relevant, describe recent precipitation, hydrologic modifications, local variations, etc.):

*Saturation in the upper 12 inches satisfies the wetland hydrology criterion.*

**09-27-13 Observations** - Soil saturation at surface.

# Parametrix

Data Plot #: 28D-SP1  
Wetland: 28D

Project/Site: ELST Re-delineation Date: 11/13/2007 Revisited 09-27-13

## SOIL

### Soil Survey Data:

Map Unit Name: Mixed Alluvial Land Drainage Class: Well drained to very poorly drained  
Field Observations Confirm Mapped Type?

Taxonomy (Subgroup): N/A Yes  No  NA

### Profile Description:

Depth (Inches)	Horizon Designation	Matrix Color (Munsell Moist)	Mottle Color (Munsell Moist)	Mottle Abundance/Contrast	Texture, Concretions, Rhizospheres, etc.
0-18	A	10YR 2/1	none	none	gravelly loam

### Hydric Soil Indicators:

- |   |   |
|---|---|
| <input type="checkbox"/> Histosol                               | <input type="checkbox"/> Listed on Hydric Soils List      |
| <input type="checkbox"/> Histic Epipedon                        | <input type="checkbox"/> Fe/Mn Concretions                |
| <input type="checkbox"/> Sulfidic Odor                          | <input type="checkbox"/> Organic Streaking in Sandy Soils |
| <input type="checkbox"/> Aquic or Peraguc Moisture Regime       | <input type="checkbox"/> Mottles (Redoximorphic Features) |
| <input type="checkbox"/> Reducing Conditions                    | <input type="checkbox"/> Other (Explain in Remarks)       |
| <input checked="" type="checkbox"/> Gleyed or Low-Chroma Colors |   |
| <input type="checkbox"/> High Organic Content in Surface Layer  |   |

Remarks (Describe soil disturbances, local variations, etc.):  
*Low chroma soil color satisfies the hydric soil criterion.*

## WETLAND DETERMINATION

Hydrophytic Vegetation Present? Yes  No  Is this Sampling Point Within a Wetland?  
Hydric Soils Present? Yes  No  Yes  No   
Wetland Hydrology Present? Yes  No

Remarks  
*Wetland vegetation, hydrology, and soil criteria are met. Therefore, the sample plot is located in a wetland.*

# Parametrix

Data Plot #: 28D-SP2  
Wetland: Upland near 28D

## WETLAND DETERMINATION (Modified from: 1987 ACOE Wetlands Delineation Manual)

Project/Site: ELST Re-delineation Date: 11/13/2007 Revised 09-27-13  
Applicant/Owner: King County County: King  
Investigator: Chipper Maney, Erik Christensen State: WA  
 1987 Method  1997 WA St. Method Community ID: Upland Shrub  
Do Normal Circumstances exist on the site? Yes X No \_\_\_\_\_ Field Plot ID: 28D-SP2  
Is the site significantly disturbed (Atypical Situation)? Yes \_\_\_\_\_ No X  
Is the area a potential Problem Area? Yes \_\_\_\_\_ No X

**Remarks** (Explain sample location, disturbances, problem areas):

*Two wetlands were named 28B. This sample plot is has been changed from 28B to 28D to avoid wetland name duplication. This wetland is located at station 452+00. This sample plot is located approximately 5 feet north of Flag 28D-1.*

**VEGETATION** (✓ Dominant species are checked)

Plant Species	% Cover	Stratum	Indicator
✓ 1. <u>Equisetum telmateia</u>	<u>20</u>	<u>Herb</u>	<u>FACW</u>
2. <u>Hedera helix</u>	<u>15</u>	<u>Herb</u>	<u>NL</u>
✓ 3. <u>Holcus lanatus</u>	<u>20</u>	<u>Herb</u>	<u>FAC</u>
4. <u>Juncus spp.</u>	<u>10</u>	<u>Herb</u>	<u>Unk</u>
5. <u>Lotus corniculatus</u>	<u>10</u>	<u>Herb</u>	<u>FAC</u>
✓ 6. <u>Rubus armeniacus</u>	<u>40</u>	<u>Shrub</u>	<u>FACU</u>

**09-27-13 Observations**

*Equisetum telmateia 20%  
Hedera helix 60%  
Lotus corniculatus 40%  
Rubus armeniacus 30%*

Percent of **Dominant Species** that are OBL, FACW, or FAC (except FAC-). Include species noted (\*) as showing morphological adaptations to wetlands. "T" indicates trace. 67

**Remarks** (Describe disturbances, relevant local variations, seasonal effects, etc.):

*The percent of dominant species that are hydrophytic is greater than 50 percent. Hydrophytic vegetation criterion is satisfied.*

### HYDROLOGY

**Recorded Data** (Describe in Remarks):

\_\_\_\_\_ Stream, Lake, or Tide Gage  
\_\_\_\_\_ Aerial Photograph  
\_\_\_\_\_ Other  
X No Recorded Data Available

**Wetland Hydrology Indicators** (Describe in Remarks):

Primary Indicators:

\_\_\_\_\_ Inundated  
\_\_\_\_\_ Saturated in Upper 12 inches  
\_\_\_\_\_ Water Marks  
\_\_\_\_\_ Drift Lines  
\_\_\_\_\_ Sediment Deposits  
\_\_\_\_\_ Drainage Patterns in Wetlands

**Field Observations:**

Depth of Surface Water: none (in.)  
Depth to Free Water in Pit: none (in.)  
Depth to Saturated Soil: none (in.)

Secondary Indicators (2 or more required):

\_\_\_\_\_ Oxidized Rhizospheres in Upper 12 inches  
\_\_\_\_\_ Water-Stained Leaves  
\_\_\_\_\_ Local Soil Survey Data  
\_\_\_\_\_ Other (Explain in Remarks)

**Remarks** (As relevant, describe recent precipitation, hydrologic modifications, local variations, etc.):

*No indicators of wetland hydrology are present. Wetland hydrology criterion is not satisfied.*

**09-27-13 Observations** - No indicators of wetland hydrology present.

# Parametrix

Data Plot #: 28D-SP2  
Wetland: Upland near 28D

Project/Site: ELST Re-delineation Date: 11/13/2007 Revisited 09-27-13

## SOIL

### Soil Survey Data:

Map Unit Name: Mixed Alluvial Land Drainage Class: Well drained to very poorly drained  
Field Observations Confirm Mapped Type?

Taxonomy (Subgroup): N/A Yes  No  NA

### Profile Description:

Depth (Inches)	Horizon Designation	Matrix Color (Munsell Moist)	Mottle Color (Munsell Moist)	Mottle Abundance/Contrast	Texture, Concretions, Rhizospheres, etc.
0-4					fill
4-18	A	10YR 2/1	none	none	gravelly loam

### Hydric Soil Indicators:

- |  |   |
|--|---|
| <input type="checkbox"/> Histosol                              | <input type="checkbox"/> Listed on Hydric Soils List      |
| <input type="checkbox"/> Histic Epipedon                       | <input type="checkbox"/> Fe/Mn Concretions                |
| <input type="checkbox"/> Sulfidic Odor                         | <input type="checkbox"/> Organic Streaking in Sandy Soils |
| <input type="checkbox"/> Aquic or Peraguc Moisture Regime      | <input type="checkbox"/> Mottles (Redoximorphic Features) |
| <input type="checkbox"/> Reducing Conditions                   | <input type="checkbox"/> Other (Explain in Remarks)       |
| <input type="checkbox"/> Gleyed or Low-Chroma Colors           |   |
| <input type="checkbox"/> High Organic Content in Surface Layer |   |

### Remarks (Describe soil disturbances, local variations, etc.):

Concrete, gravel, and fill were found in the top 4 inches of the soil profile. No indicators of hydric soil are present. Hydric soil criterion is not satisfied.

## WETLAND DETERMINATION

Hydrophytic Vegetation Present? Yes  No  Is this Sampling Point Within a Wetland?  
Hydric Soils Present? Yes  No  Yes  No   
Wetland Hydrology Present? Yes  No

### Remarks

Hydric soil and wetland hydrology criteria are not satisfied. Therefore, the sample plot is not located in a wetland.

Exhibit 16  
SSDP2016-00415  
000939



# WETLAND DETERMINATION DATA FORM – Western Mountains, Valleys, and Coast Region

Project Site: ELST - South Sammamish Segment City/County: Sammamish/King Sampling Date: 11-01-13  
 Applicant/Owner: King County State: WA Sampling Point: W28E-SP1  
 Investigator(s): C. Worsley, M. Maynard Section, Township, Range: S29, T25N, R06E  
 Landform (hillslope, terrace, etc.): depression Local relief (concave, convex, none): concave Slope (%): 25  
 Subregion (LRR): A Lat: \_\_\_\_\_ Long: \_\_\_\_\_ Datum: \_\_\_\_\_  
 Soil Map Unit Name: Alderwood and Kitsap soils, very steep NWI classification: PEM  
 Are climatic / hydrologic conditions on the site typical for this time of year? Yes  No  (If no, explain in Remarks.)  
 Are Vegetation , Soil , or Hydrology , significantly disturbed? Are "Normal Circumstances" present? Yes  No   
 Are Vegetation , Soil , or Hydrology , naturally problematic? (If needed, explain any answers in Remarks.)

### SUMMARY OF FINDINGS – Attach site map showing sampling point locations, transects, important features, etc.

Hydrophytic Vegetation Present?	Yes <input checked="" type="checkbox"/>	No <input type="checkbox"/>	<b>Is the Sampled Area within a Wetland?</b>	Yes <input checked="" type="checkbox"/>	No <input type="checkbox"/>
Hydric Soil Present?	Yes <input checked="" type="checkbox"/>	No <input type="checkbox"/>		Yes <input checked="" type="checkbox"/>	No <input type="checkbox"/>
Wetland Hydrology Present?	Yes <input checked="" type="checkbox"/>	No <input type="checkbox"/>		Yes <input checked="" type="checkbox"/>	No <input type="checkbox"/>
Remarks: Sample plot is located on east side of ditch in wetland, approximately 6 feet east of trail, 20 feet west of large Acer macrophyllum.					

### VEGETATION – Use scientific names of plants

Tree Stratum (Plot size: <u>NA</u> )	Absolute % Cover	Dominant Species?	Indicator Status	Dominance Test Worksheet:																
1. _____	_____	_____	_____	Number of Dominant Species That Are OBL, FACW, or FAC: <u>2</u> (A)  Total Number of Dominant Species Across All Strata: <u>2</u> (B)  Percent of Dominant Species That Are OBL, FACW, or FAC: <u>100</u> (A/B)																
2. _____	_____	_____	_____																	
3. _____	_____	_____	_____																	
4. _____	_____	_____	_____																	
50% = _____, 20% = _____	_____	= Total Cover		<b>Prevalence Index worksheet:</b>  <table style="width: 100%; border: none;"> <tr> <td style="text-align: center;"><u>Total % Cover of:</u></td> <td style="text-align: center;"><u>Multiply by:</u></td> </tr> <tr> <td>OBL species _____</td> <td>x1 = _____</td> </tr> <tr> <td>FACW species _____</td> <td>x2 = _____</td> </tr> <tr> <td>FAC species _____</td> <td>x3 = _____</td> </tr> <tr> <td>FACU species _____</td> <td>x4 = _____</td> </tr> <tr> <td>UPL species _____</td> <td>x5 = _____</td> </tr> <tr> <td>Column Totals: _____ (A)</td> <td>_____ (B)</td> </tr> <tr> <td colspan="2" style="text-align: center;">Prevalence Index = B/A = _____</td> </tr> </table>	<u>Total % Cover of:</u>	<u>Multiply by:</u>	OBL species _____	x1 = _____	FACW species _____	x2 = _____	FAC species _____	x3 = _____	FACU species _____	x4 = _____	UPL species _____	x5 = _____	Column Totals: _____ (A)	_____ (B)	Prevalence Index = B/A = _____	
<u>Total % Cover of:</u>	<u>Multiply by:</u>																			
OBL species _____	x1 = _____																			
FACW species _____	x2 = _____																			
FAC species _____	x3 = _____																			
FACU species _____	x4 = _____																			
UPL species _____	x5 = _____																			
Column Totals: _____ (A)	_____ (B)																			
Prevalence Index = B/A = _____																				
<u>Sapling/Shrub Stratum</u> (Plot size: <u>NA</u> )																				
1. _____	_____	_____	_____	<b>Hydrophytic Vegetation Indicators:</b> <input type="checkbox"/> 1 – Rapid Test for Hydrophytic Vegetation <input checked="" type="checkbox"/> 2 - Dominance Test is >50% <input type="checkbox"/> 3 - Prevalence Index is ≤3.0 <sup>1</sup> <input type="checkbox"/> 4 - Morphological Adaptations <sup>1</sup> (Provide supporting data in Remarks or on a separate sheet) <input type="checkbox"/> 5 - Wetland Non-Vascular Plants <sup>1</sup> <input type="checkbox"/> Problematic Hydrophytic Vegetation <sup>1</sup> (Explain)  <sup>1</sup> Indicators of hydric soil and wetland hydrology must be present, unless disturbed or problematic.																
2. _____	_____	_____	_____																	
3. _____	_____	_____	_____																	
4. _____	_____	_____	_____																	
5. _____	_____	_____	_____																	
50% = _____, 20% = _____	_____	= Total Cover																		
<u>Herb Stratum</u> (Plot size: <u>3 feet, confined to wetland boundary</u> )																				
1. <u>Phalaris arundinacea</u>	<u>75</u>	<u>yes</u>	<u>FACW</u>																	
2. <u>Veronica americana</u>	<u>45</u>	<u>yes</u>	<u>OBL</u>																	
3. <u>Calystegia sepium</u>	<u>20</u>	<u>no</u>	<u>FAC</u>																	
4. _____	_____	_____	_____																	
5. _____	_____	_____	_____																	
6. _____	_____	_____	_____																	
7. _____	_____	_____	_____																	
8. _____	_____	_____	_____																	
9. _____	_____	_____	_____																	
10. _____	_____	_____	_____																	
11. _____	_____	_____	_____																	
50% = <u>70</u> , 20% = <u>28</u>	<u>140</u>	= Total Cover																		
<u>Woody Vine Stratum</u> (Plot size: _____)																				
1. _____	_____	_____	_____	<b>Hydrophytic Vegetation Present?</b> Yes <input checked="" type="checkbox"/> No <input type="checkbox"/>																
2. _____	_____	_____	_____																	
50% = _____, 20% = _____	_____	= Total Cover																		
% Bare Ground in Herb Stratum <u>0</u>																				

Remarks: Species with less than 5% cover are not considered dominant.

**Exhibit 16**

**SSDP2016-00415**

**000940**

**SOIL**

Profile Description: (Describe to the depth needed to document the indicator or confirm the absence of indicators.)								
Depth (inches)	Matrix		Redox Features				Texture	Remarks
	Color (moist)	%	Color (moist)	%	Type <sup>1</sup>	Loc <sup>2</sup>		
0-6	10YR 2/1	100	-	-	-	-	sa. loam	
6-18	10YR 3/1	95	10YR 3/6	5	C	M	gr. sa. loam	with cobbles

<sup>1</sup>Type: C= Concentration, D=Depletion, RM=Reduced Matrix, CS=Covered or Coated Sand Grains.      <sup>2</sup>Location: PL=Pore Lining, M=Matrix

Hydric Soil Indicators: (Applicable to all LRRs, unless otherwise noted.)			Indicators for Problematic Hydric Soils <sup>3</sup> :		
<input type="checkbox"/> Histosol (A1)	<input type="checkbox"/> Sandy Redox (S5)	<input type="checkbox"/> 2 cm Muck (A10)			
<input type="checkbox"/> Histic Epipedon (A2)	<input type="checkbox"/> Stripped Matrix (S6)	<input type="checkbox"/> Red Parent Material (TF2)			
<input type="checkbox"/> Black Histic (A3)	<input type="checkbox"/> Loamy Mucky Mineral (F1) (except MLRA 1)	<input type="checkbox"/> Very Shallow Dark Surface (TF12)			
<input type="checkbox"/> Hydrogen Sulfide (A4)	<input type="checkbox"/> Loamy Gleyed Matrix (F2)	<input type="checkbox"/> Other (Explain in Remarks)			
<input type="checkbox"/> Depleted Below Dark Surface (A11)	<input type="checkbox"/> Depleted Matrix (F3)				
<input type="checkbox"/> Thick Dark Surface (A12)	<input checked="" type="checkbox"/> Redox Dark Surface (F6)				
<input type="checkbox"/> Sandy Mucky Mineral (S1)	<input type="checkbox"/> Depleted Dark Surface (F7)				
<input type="checkbox"/> Sandy Gleyed Matrix (S4)	<input type="checkbox"/> Redox Depressions (F8)				

<sup>3</sup>Indicators of hydrophytic vegetation and wetland hydrology must be present, unless disturbed or problematic.

<b>Restrictive Layer (if present):</b> Type: _____ Depth (inches): _____	<b>Hydric Soils Present?</b> Yes <input checked="" type="checkbox"/> No <input type="checkbox"/>
--	--

Remarks:

**HYDROLOGY**

Wetland Hydrology Indicators:			
Primary Indicators (minimum of one required; check all that apply)		Secondary Indicators (2 or more required)	
<input type="checkbox"/> Surface Water (A1)	<input type="checkbox"/> Water-Stained Leaves (B9)	<input type="checkbox"/> Water-Stained Leaves (B9)	
<input type="checkbox"/> High Water Table (A2)	<b>(except MLRA 1, 2, 4A, and 4B)</b>	<b>(MLRA 1, 2, 4A, and 4B)</b>	
<input checked="" type="checkbox"/> Saturation (A3)	<input type="checkbox"/> Salt Crust (B11)	<input type="checkbox"/> Drainage Patterns (B10)	
<input type="checkbox"/> Water Marks (B1)	<input type="checkbox"/> Aquatic Invertebrates (B13)	<input type="checkbox"/> Dry-Season Water Table (C2)	
<input type="checkbox"/> Sediment Deposits (B2)	<input type="checkbox"/> Hydrogen Sulfide Odor (C1)	<input type="checkbox"/> Saturation Visible on Aerial Imagery (C9)	
<input type="checkbox"/> Drift Deposits (B3)	<input type="checkbox"/> Oxidized Rhizospheres along Living Roots (C3)	<input type="checkbox"/> Geomorphic Position (D2)	
<input type="checkbox"/> Algal Mat or Crust (B4)	<input type="checkbox"/> Presence of Reduced Iron (C4)	<input type="checkbox"/> Shallow Aquitard (D3)	
<input type="checkbox"/> Iron Deposits (B5)	<input type="checkbox"/> Recent Iron Reduction in Tilled Soils (C6)	<input type="checkbox"/> FAC-Neutral Test (D5)	
<input type="checkbox"/> Surface Soil Cracks (B6)	<input type="checkbox"/> Stunted or Stresses Plants (D1) (LRR A)	<input type="checkbox"/> Raised Ant Mounds (D6) (LRR A)	
<input type="checkbox"/> Inundation Visible on Aerial Imagery (B7)	<input type="checkbox"/> Other (Explain in Remarks)	<input type="checkbox"/> Frost-Heave Hummocks (D7)	
<input type="checkbox"/> Sparsely Vegetated Concave Surface (B8)			

<b>Field Observations:</b> Surface Water Present?    Yes <input type="checkbox"/> No <input checked="" type="checkbox"/> Depth (inches): _____ Water Table Present?    Yes <input checked="" type="checkbox"/> No <input type="checkbox"/> Depth (inches): <u>15</u> Saturation Present? (includes capillary fringe)    Yes <input checked="" type="checkbox"/> No <input type="checkbox"/> Depth (inches): <u>surface</u>	<b>Wetland Hydrology Present?</b> Yes <input checked="" type="checkbox"/> No <input type="checkbox"/>
---	---

Describe Recorded Data (stream gauge, monitoring well, aerial photos, previous inspections), if available:

Remarks:

**Exhibit 16**  
**SSDP2016-00415**

# WETLAND DETERMINATION DATA FORM – Western Mountains, Valleys, and Coast Region

Project Site: ELST - South Sammamish Segment City/County: Sammamish/King Sampling Date: 11-01-13  
 Applicant/Owner: King County State: WA Sampling Point: W28E-SP2  
 Investigator(s): C. Worsley, M. Maynard Section, Township, Range: S29, T25N, R06E  
 Landform (hillslope, terrace, etc.): hillslope Local relief (concave, convex, none): convex Slope (%): 15  
 Subregion (LRR): A Lat: \_\_\_\_\_ Long: \_\_\_\_\_ Datum: \_\_\_\_\_  
 Soil Map Unit Name: Alderwood and Kitsap soils, very steep NWI classification: NA  
 Are climatic / hydrologic conditions on the site typical for this time of year? Yes  No  (If no, explain in Remarks.)  
 Are Vegetation , Soil , or Hydrology , significantly disturbed? Are "Normal Circumstances" present? Yes  No   
 Are Vegetation , Soil , or Hydrology , naturally problematic? (If needed, explain any answers in Remarks.)

### SUMMARY OF FINDINGS – Attach site map showing sampling point locations, transects, important features, etc.

Hydrophytic Vegetation Present?	Yes <input type="checkbox"/>	No <input checked="" type="checkbox"/>	<b>Is the Sampled Area within a Wetland?</b>	Yes <input type="checkbox"/>	No <input checked="" type="checkbox"/>
Hydric Soil Present?	Yes <input type="checkbox"/>	No <input checked="" type="checkbox"/>		Yes <input type="checkbox"/>	No <input checked="" type="checkbox"/>
Wetland Hydrology Present?	Yes <input type="checkbox"/>	No <input checked="" type="checkbox"/>		Yes <input type="checkbox"/>	No <input checked="" type="checkbox"/>
Remarks: Sample plot is located upslope (east) of ditch and approximately 20 feet northwest of large Acer macrophyllum.					

### VEGETATION – Use scientific names of plants

Tree Stratum (Plot size: <u>30 feet</u> )	Absolute % Cover	Dominant Species?	Indicator Status	Dominance Test Worksheet:																
1. <u>Acer macrophyllum</u>	<u>40</u>	<u>yes</u>	<u>FACU</u>	Number of Dominant Species That Are OBL, FACW, or FAC: <u>4</u> (A)  Total Number of Dominant Species Across All Strata: <u>8</u> (B)  Percent of Dominant Species That Are OBL, FACW, or FAC: <u>50</u> (A/B)																
2. <u>Alnus rubra</u>	<u>15</u>	<u>yes</u>	<u>FAC</u>																	
3. _____	_____	_____	_____																	
4. _____	_____	_____	_____																	
50% = <u>28</u> , 20% = <u>11</u>	<u>55</u>	= Total Cover		<b>Prevalence Index worksheet:</b> <table style="width: 100%; border: none;"> <tr> <td style="text-align: center;">Total % Cover of:</td> <td style="text-align: center;">Multiply by:</td> </tr> <tr> <td>OBL species _____</td> <td>x1 = _____</td> </tr> <tr> <td>FACW species _____</td> <td>x2 = _____</td> </tr> <tr> <td>FAC species _____</td> <td>x3 = _____</td> </tr> <tr> <td>FACU species _____</td> <td>x4 = _____</td> </tr> <tr> <td>UPL species _____</td> <td>x5 = _____</td> </tr> <tr> <td>Column Totals: _____ (A)</td> <td>_____ (B)</td> </tr> <tr> <td colspan="2" style="text-align: center;">Prevalence Index = B/A = _____</td> </tr> </table>	Total % Cover of:	Multiply by:	OBL species _____	x1 = _____	FACW species _____	x2 = _____	FAC species _____	x3 = _____	FACU species _____	x4 = _____	UPL species _____	x5 = _____	Column Totals: _____ (A)	_____ (B)	Prevalence Index = B/A = _____	
Total % Cover of:	Multiply by:																			
OBL species _____	x1 = _____																			
FACW species _____	x2 = _____																			
FAC species _____	x3 = _____																			
FACU species _____	x4 = _____																			
UPL species _____	x5 = _____																			
Column Totals: _____ (A)	_____ (B)																			
Prevalence Index = B/A = _____																				
Sapling/Shrub Stratum (Plot size: <u>10 feet</u> )																				
1. <u>Rosa pisocarpa</u>	<u>15</u>	<u>yes</u>	<u>FAC</u>																	
2. <u>Rubus parviflorus</u>	<u>15</u>	<u>yes</u>	<u>FACU</u>																	
3. <u>Corylus cornuta</u>	<u>8</u>	<u>yes</u>	<u>FACU</u>																	
4. _____	_____	_____	_____																	
5. _____	_____	_____	_____																	
50% = <u>19</u> , 20% = <u>8</u>	<u>38</u>	= Total Cover																		
Herb Stratum (Plot size: <u>3 feet</u> )																				
1. <u>Equisetum telmateia</u>	<u>5</u>	<u>yes</u>	<u>FACW</u>																	
2. <u>Calystegia sepium</u>	<u>5</u>	<u>yes</u>	<u>FAC</u>																	
3. _____	_____	_____	_____																	
4. _____	_____	_____	_____																	
5. _____	_____	_____	_____																	
6. _____	_____	_____	_____																	
7. _____	_____	_____	_____																	
8. _____	_____	_____	_____																	
9. _____	_____	_____	_____																	
10. _____	_____	_____	_____																	
11. _____	_____	_____	_____																	
50% = <u>5</u> , 20% = <u>2</u>	<u>10</u>	= Total Cover																		
Woody Vine Stratum (Plot size: <u>10 feet</u> )																				
1. <u>Rubus armeniacus</u>	<u>75</u>	<u>yes</u>	<u>FACU</u>																	
2. _____	_____	_____	_____																	
50% = _____, 20% = _____	<u>75</u>	= Total Cover																		
% Bare Ground in Herb Stratum <u>0</u>																				
<table style="width: 100%; border: none;"> <tr> <td style="width: 35%;"><b>Hydrophytic Vegetation Present?</b></td> <td style="width: 10%;">Yes <input type="checkbox"/></td> <td style="width: 10%;">No <input checked="" type="checkbox"/></td> </tr> </table>				<b>Hydrophytic Vegetation Present?</b>	Yes <input type="checkbox"/>	No <input checked="" type="checkbox"/>														
<b>Hydrophytic Vegetation Present?</b>	Yes <input type="checkbox"/>	No <input checked="" type="checkbox"/>																		

Remarks: Species with less than 5% cover are not considered dominant.

**Exhibit 16**  
**SSDP2016-00415**

**SOIL**

**Profile Description: (Describe to the depth needed to document the indicator or confirm the absence of indicators.)**

Depth (inches)	Matrix		Redox Features				Texture	Remarks
	Color (moist)	%	Color (moist)	%	Type <sup>1</sup>	Loc <sup>2</sup>		
0-5	10YR 2/1	100	-	-	-	-	gr. sa. loam	with cobbles
5-18	10YR 3/2	100	-	-	-	-	gr. sa. loam	with cobbles
_____	_____	_____	_____	_____	_____	_____	_____	_____
_____	_____	_____	_____	_____	_____	_____	_____	_____
_____	_____	_____	_____	_____	_____	_____	_____	_____
_____	_____	_____	_____	_____	_____	_____	_____	_____

<sup>1</sup>Type: C= Concentration, D=Depletion, RM=Reduced Matrix, CS=Covered or Coated Sand Grains. <sup>2</sup>Location: PL=Pore Lining, M=Matrix

**Hydric Soil Indicators: (Applicable to all LRRs, unless otherwise noted.)**

- Histosol (A1)
- Histic Epipedon (A2)
- Black Histic (A3)
- Hydrogen Sulfide (A4)
- Depleted Below Dark Surface (A11)
- Thick Dark Surface (A12)
- Sandy Mucky Mineral (S1)
- Sandy Gleyed Matrix (S4)
- Sandy Redox (S5)
- Stripped Matrix (S6)
- Loamy Mucky Mineral (F1) **(except MLRA 1)**
- Loamy Gleyed Matrix (F2)
- Depleted Matrix (F3)
- Redox Dark Surface (F6)
- Depleted Dark Surface (F7)
- Redox Depressions (F8)

**Indicators for Problematic Hydric Soils<sup>3</sup>:**

- 2 cm Muck (A10)
- Red Parent Material (TF2)
- Very Shallow Dark Surface (TF12)
- Other (Explain in Remarks)

<sup>3</sup>Indicators of hydrophytic vegetation and wetland hydrology must be present, unless disturbed or problematic.

**Restrictive Layer (if present):**

Type: \_\_\_\_\_

Depth (inches): \_\_\_\_\_

Hydric Soils Present? Yes  No

Remarks:

**HYDROLOGY**

**Wetland Hydrology Indicators:**

Primary Indicators (minimum of one required; check all that apply)

- Surface Water (A1)
- High Water Table (A2)
- Saturation (A3)
- Water Marks (B1)
- Sediment Deposits (B2)
- Drift Deposits (B3)
- Algal Mat or Crust (B4)
- Iron Deposits (B5)
- Surface Soil Cracks (B6)
- Inundation Visible on Aerial Imagery (B7)
- Sparsely Vegetated Concave Surface (B8)
- Water-Stained Leaves (B9) **(except MLRA 1, 2, 4A, and 4B)**
- Salt Crust (B11)
- Aquatic Invertebrates (B13)
- Hydrogen Sulfide Odor (C1)
- Oxidized Rhizospheres along Living Roots (C3)
- Presence of Reduced Iron (C4)
- Recent Iron Reduction in Tilled Soils (C6)
- Stunted or Stresses Plants (D1) **(LRR A)**
- Other (Explain in Remarks)

Secondary Indicators (2 or more required)

- Water-Stained Leaves (B9) **(MLRA 1, 2, 4A, and 4B)**
- Drainage Patterns (B10)
- Dry-Season Water Table (C2)
- Saturation Visible on Aerial Imagery (C9)
- Geomorphic Position (D2)
- Shallow Aquitard (D3)
- FAC-Neutral Test (D5)
- Raised Ant Mounds (D6) **(LRR A)**
- Frost-Heave Hummocks (D7)

**Field Observations:**

Surface Water Present? Yes  No  Depth (inches): \_\_\_\_\_

Water Table Present? Yes  No  Depth (inches): \_\_\_\_\_

Saturation Present? (includes capillary fringe) Yes  No  Depth (inches): \_\_\_\_\_

Wetland Hydrology Present? Yes  No

Describe Recorded Data (stream gauge, monitoring well, aerial photos, previous inspections), if available:

Remarks:

Data Plot #: 29B-SP1  
 Wetland: 29B

## WETLAND DETERMINATION (Modified from: 1987 ACOE Wetlands Delineation Manual)

Project/Site: ELST Re-delineation Date: 11/8/2007 Revisited 03-20-14  
 Applicant/Owner: King County County: King County  
 Investigator: Linda Krippner/Rachel Hulscher State: WA  
 1987 Method  1977 WA St. Method Community ID: PEM  
 Do Normal Circumstances exist on the site? Yes X No        Field Plot ID: 29B-SP1  
 Is the site significantly disturbed (Atypical Situation)? Yes X No         
 Is the area a potential Problem Area? Yes        No X

**Remarks** (Explain sample location, disturbances, problem areas):  
*This sample plot is located approximately 9 feet north of Flag 29B-5.*

### VEGETATION (✓ Dominant species are checked)

Plant Species	% Cover	Stratum	Indicator
1. <u>crabgrass</u>	<u>trace</u>	<u>Herb</u>	<u>FACU</u>
2. <u>Juncus ensifolius</u>	<u>trace</u>	<u>Herb</u>	<u>FACW</u>
3. <u>moss</u>	<u>trace</u>	<u>Herb</u>	<u>NL</u>
4. <u>Poa sp.</u>	<u>trace</u>	<u>Herb</u>	<u>UNK</u>
5. <u>Ranunculus repens</u>	<u>10</u>	<u>Herb</u>	<u>FACW</u>
✓ 6. <u>various lawn grass</u>	<u>90</u>	<u>Herb</u>	<u>NL</u>
7. <u>velvetgrass</u>	<u>trace</u>	<u>Herb</u>	<u>FAC</u>

### 03-20-14 Observations

Equisetum telmateia 2%  
 Trifolium repens 8%  
 Plantago majora 2%  
 Scirpus microcarpus 2%  
 Holcus lanatus 2%  
 Juncus ensifolius 2%  
 various lawn grass 90%  
 moss 2%

Percent of **Dominant Species** that are OBL, FACW, or FAC (except FAC-). Include species noted (\*) as showing morphological adaptations to wetlands. "T" indicates trace. 0

**Remarks** (Describe disturbances, relevant local variations, seasonal effects, etc.):  
*The percent of dominant species that are hydrophytic is not greater than 50 percent. Hydrophytic vegetation criterion is not satisfied. Vegetation meets wetland criterion based on best professional judgment due to lawn maintenance and other wetland criteria.*

### HYDROLOGY

**Recorded Data** (Describe in Remarks):

       Stream, Lake, or Tide Gage  
       Aerial Photograph  
       Other  
X No Recorded Data Available

**Wetland Hydrology Indicators** (Describe in Remarks):

Primary Indicators:  
       Inundated  
X Saturated in Upper 12 inches  
       Water Marks  
       Drift Lines  
       Sediment Deposits  
       Drainage Patterns in Wetlands

**Field Observations:**

Depth of Surface Water: none (in.)  
 Depth to Free Water in Pit: none (in.)  
 Depth to Saturated Soil: 6 (in.)

Secondary Indicators (2 or more required):  
       Oxidized Rhizospheres in Upper 12 inches  
       Water-Stained Leaves  
       Local Soil Survey Data  
       Other (Explain in Remarks)

**Remarks** (As relevant, describe recent precipitation, hydrologic modifications, local variations, etc.):  
*Saturation in the upper 12 inches satisfies wetland hydrology criterion.*

# Parametrix

Data Plot #: 29B-SP1

Wetland: 29B

Project/Site: ELST Re-delineation

Date: 11/8/2007

Revisited 03-20-14

## SOIL

### Soil Survey Data:

Map Unit Name: Alderwood gravelly sandy loam, 15 to 30 % slopes

Drainage Class: Moderately well drained

Field Observations Confirm Mapped Type?

Taxonomy (Subgroup): Entic Durochrepts

Yes  No  NA

### Profile Description:

Depth (Inches)	Horizon Designation	Matrix Color (Munsell Moist)	Mottle Color (Munsell Moist)	Mottle Abundance/Contrast	Texture, Concretions, Rhizospheres, etc.
0-9	A	10YR 2/1	none	none	loam
9-16	B	2.5Y 4/1	none	none	fill material and loam

<b>03-20-14 Observations</b> - 0-6	10YR 2/1	none	none	loam
6-16	10YR 3/2 (85%)	10YR 6/4	12%	gr. sa. loam w.
		10YR 5/8	3%	small cobbles

### Hydric Soil Indicators:

- |   |   |
|---|---|
| <input type="checkbox"/> Histosol                               | <input type="checkbox"/> Listed on Hydric Soils List      |
| <input type="checkbox"/> Histic Epipedon                        | <input type="checkbox"/> Fe/Mn Concretions                |
| <input type="checkbox"/> Sulfidic Odor                          | <input type="checkbox"/> Organic Streaking in Sandy Soils |
| <input type="checkbox"/> Aquic or Peraguc Moisture Regime       | <input type="checkbox"/> Mottles (Redoximorphic Features) |
| <input type="checkbox"/> Reducing Conditions                    | <input type="checkbox"/> Other (Explain in Remarks)       |
| <input checked="" type="checkbox"/> Gleyed or Low-Chroma Colors |   |
| <input type="checkbox"/> High Organic Content in Surface Layer  |   |

Remarks (Describe soil disturbances, local variations, etc.):

*Soils are disturbed below the topsoil, fill below. Low chroma soil satisfies hydric soil criterion.*

## WETLAND DETERMINATION

Hydrophytic Vegetation Present?

Yes  No

Is this Sampling Point Within a Wetland?

Hydric Soils Present?

Yes  No

Yes  No

Wetland Hydrology Present?

Yes  No

### Remarks

*Maintained grasses meet hydrophytic vegetation criterion based on best professional judgment. Therefore all wetland criteria are met and this area is a wetland.*

**Exhibit 16**  
**SSDP2016-00415**  
**000945**

# Parametrix

Data Plot #: 29B-SP2  
Wetland: Upland near 29B

## WETLAND DETERMINATION (Modified from: 1987 ACOE Wetlands Delineation Manual)

Project/Site: ELST Re-delineation Date: 11/8/2007 Revisited 03-20-14  
Applicant/Owner: King County County: King County  
Investigator: Linda Krippner/Laura Brock State: WA  
 1987 Method  1997 WA St. Method Community ID: Upland Shrub  
Do Normal Circumstances exist on the site? Yes X No        Field Plot ID: 29B-SP2  
Is the site significantly disturbed (Atypical Situation)? Yes X No         
Is the area a potential Problem Area? Yes        No X

**Remarks** (Explain sample location, disturbances, problem areas):  
*This sample plot is located approximately 3 feet northwest of Flag 29B-2.*

### VEGETATION (✓ Dominant species are checked)

	Plant Species	% Cover	Stratum	Indicator
1.	<u>Hypochaeris radicata spotted car's ear</u>	<u>trace</u>	<u>Herb</u>	<u>FACU</u>
✓ 2.	<u>various lawn grasses</u>	<u>40</u>	<u>Herb</u>	<u>NL</u>
3.	<u>holly</u>	<u>2</u>	<u>Shrub</u>	<u>NL</u>
4.	<u>ornamental cedar</u>	<u>5</u>	<u>Shrub</u>	<u>NL</u>
✓ 5.	<u>ornamental shrub - unknown</u>	<u>50</u>	<u>Shrub</u>	<u>NL</u>
6.	<u>Rubus armeniacus</u>	<u>5</u>	<u>Shrub</u>	<u>FACU</u>

**03-20-14 Observations**  
Hypochaeris radicata 2%  
various lawn grasses 40%  
Ilex aquifolium 2%  
arbor vitae 10%  
ornamental shrub (unknown) 50%  
Rubus armeniacus 2%

Percent of **Dominant Species** that are OBL, FACW, or FAC (except FAC-). Include species noted (\*) as showing morphological adaptations to wetlands. "T" indicates trace. 0

**Remarks** (Describe disturbances, relevant local variations, seasonal effects, etc.):  
*Area is landscaped. Vegetation does not meet wetland vegetation criterion.*

### HYDROLOGY

#### Recorded Data (Describe in Remarks):

       Stream, Lake, or Tide Gage  
       Aerial Photograph  
       Other  
X No Recorded Data Available

#### Field Observations:

Depth of Surface Water: none (in.)  
Depth to Free Water in Pit: none (in.)  
Depth to Saturated Soil: none (in.)

#### Wetland Hydrology Indicators (Describe in Remarks):

##### Primary Indicators:

       Inundated  
       Saturated in Upper 12 inches  
       Water Marks  
       Drift Lines  
       Sediment Deposits  
       Drainage Patterns in Wetlands

##### Secondary Indicators (2 or more required):

       Oxidized Rhizospheres in Upper 12 inches  
       Water-Stained Leaves  
       Local Soil Survey Data  
       Other (Explain in Remarks)

**Remarks** (As relevant, describe recent precipitation, hydrologic modifications, local variations, etc.):  
*No primary or secondary indicators of hydrology are present. Wetland hydrology criterion is not satisfied.*

**Exhibit 16**  
**SSDP2016-00415**  
**000946**

# Parametrix

Data Plot #: 29B-SP2  
Wetland: Upland near 29B

Project/Site: ELST Re-delineation Date: 11/8/2007 Revisited 03-20-14

## SOIL

### Soil Survey Data:

Map Unit Name: Alderwood gravelly sandy loam, 15 to 30 % slopes Drainage Class: Moderately well drained  
Field Observations Confirm Mapped Type?

Taxonomy (Subgroup): Entic Durochrepts Yes  No  NA

### Profile Description:

Depth (Inches)	Horizon Designation	Matrix Color (Munsell Moist)	Mottle Color (Munsell Moist)	Mottle Abundance/Contrast	Texture, Concretions, Rhizospheres, etc.
0-7	A	10YR 2/1	none	none	gravelly sandy loam
7-16	A2	10YR 2/2	none	none	gravelly sandy loam

### Hydric Soil Indicators:

- |  |   |
|--|---|
| <input type="checkbox"/> Histosol                              | <input type="checkbox"/> Listed on Hydric Soils List      |
| <input type="checkbox"/> Histic Epipedon                       | <input type="checkbox"/> Fe/Mn Concretions                |
| <input type="checkbox"/> Sulfidic Odor                         | <input type="checkbox"/> Organic Streaking in Sandy Soils |
| <input type="checkbox"/> Aquic or Peraguc Moisture Regime      | <input type="checkbox"/> Mottles (Redoximorphic Features) |
| <input type="checkbox"/> Reducing Conditions                   | <input type="checkbox"/> Other (Explain in Remarks)       |
| <input type="checkbox"/> Gleyed or Low-Chroma Colors           |   |
| <input type="checkbox"/> High Organic Content in Surface Layer |   |

Remarks (Describe soil disturbances, local variations, etc.):  
*Soils do not meet hydric soil criterion.*

## WETLAND DETERMINATION

Hydrophytic Vegetation Present? Yes  No  Is this Sampling Point Within a Wetland?  
Hydric Soils Present? Yes  No  Yes  No   
Wetland Hydrology Present? Yes  No

Remarks  
*None of the wetland criteria are met. Therefore, the sample plot is not located in a wetland.*



Data Plot #: 29C-SP1  
Wetland: 29C

## WETLAND DETERMINATION (Modified from: 1987 ACOE Wetlands Delineation Manual)

Project/Site: ELST Re-delineation Date: 11/8/2007 Revisited 03-20-14  
Applicant/Owner: King County County: King County  
Investigator: Linda Krippner/Laura Brock State: WA  
 1987 Method  1997 WA St. Method Community ID: PFO  
Do Normal Circumstances exist on the site? Yes X No \_\_\_\_\_ Field Plot ID: 29C-SP1  
Is the site significantly disturbed (Atypical Situation)? Yes \_\_\_\_\_ No X  
Is the area a potential Problem Area? Yes \_\_\_\_\_ No X

**Remarks** (Explain sample location, disturbances, problem areas):

*This sample plot is located approximately 7 feet west of the eastern boundary and 17 feet north of the southern boundary of Wetland 29C.*

### VEGETATION (✓ Dominant species are checked)

Plant Species	% Cover	Stratum	Indicator
✓ 1. <u>Equisetum telmateia</u>	<u>90</u>	<u>Herb</u>	<u>FACW</u>
2. <u>Hedera helix</u>	<u>15</u>	<u>Shrub</u>	<u>NL</u>
✓ 3. <u>Physocarpus capitatus</u>	<u>30</u>	<u>Shrub</u>	<u>FACW-</u>
4. <u>Rubus armeniacus</u>	<u>15</u>	<u>Shrub</u>	<u>FACU</u>
✓ 5. <u>Rubus spectabilis</u>	<u>75</u>	<u>Shrub</u>	<u>FAC+</u>
✓ 6. <u>Populus balsamifera</u>	<u>80</u>	<u>Tree</u>	<u>FAC</u>

**03-20-14 Observations**  
Equisetum hyemale 20%  
Equisetum telmateia 45%  
Hedera helix 35%  
Ilex aquifolium 5%  
Physocarpus capitatus 30%  
Rubus armeniacus 5%  
Rubus spectabilis 75%  
Salix lucida 15%  
Populus balsamifera 80%

Percent of **Dominant Species** that are OBL, FACW, or FAC (except FAC-). Include species noted (\*) as showing morphological adaptations to wetlands. "T" indicates trace. 100

**Remarks** (Describe disturbances, relevant local variations, seasonal effects, etc.):

*The percent of dominant species that are hydrophytic is greater than 50 percent. Therefore, the hydrophytic vegetation criterion is satisfied.*

### HYDROLOGY

**Recorded Data** (Describe in Remarks):

X Stream, Lake, or Tide Gage  
\_\_\_\_\_ Aerial Photograph  
\_\_\_\_\_ Other  
X No Recorded Data Available

**Wetland Hydrology Indicators** (Describe in Remarks):

Primary Indicators:  
\_\_\_\_\_ Inundated  
X Saturated in Upper 12 inches  
\_\_\_\_\_ Water Marks  
\_\_\_\_\_ Drift Lines  
\_\_\_\_\_ Sediment Deposits  
\_\_\_\_\_ Drainage Patterns in Wetlands

**Field Observations:**

Depth of Surface Water: none (in.)  
Depth to Free Water in Pit: 10 (in.)  
Depth to Saturated Soil: 5 (in.)

Secondary Indicators (2 or more required):  
\_\_\_\_\_ Oxidized Rhizospheres in Upper 12 inches  
\_\_\_\_\_ Water-Stained Leaves  
\_\_\_\_\_ Local Soil Survey Data  
\_\_\_\_\_ Other (Explain in Remarks)

**Remarks** (As relevant, describe recent precipitation, hydrologic modifications, local variations, etc.):

*Soil saturation in the upper 12 inches satisfies wetland hydrology criterion.*

**03-20-14 Observations** - Soil saturated at surface. Free water in pit at 9 inches.

# Parametrix

Data Plot #: 29C-SP1  
Wetland: 29C

Project/Site: ELST Re-delineation Date: 11/8/2007 Revisited 03-20-14

## SOIL

### Soil Survey Data:

Map Unit Name: Kitsap Silt Loam 2 to 8% slopes Drainage Class: Moderately well drained  
Field Observations Confirm Mapped Type?

Taxonomy (Subgroup): Dystric Xerochrepts Yes  No  NA

### Profile Description:

Depth (Inches)	Horizon Designation	Matrix Color (Munsell Moist)	Mottle Color (Munsell Moist)	Mottle Abundance/Contrast	Texture, Concretions, Rhizospheres, etc.
0-12	A	10YR 2/1	none	none	peat
12-16	B				sand gravel

<b>03-20-14 Observations</b>						
0-12	10YR 2/1	none	none	peaty mineral (loam)		
12-16	-	-	-	sand gravel		

### Hydric Soil Indicators:

- |  |   |
|--|---|
| <input checked="" type="checkbox"/> Histosol                   | <input type="checkbox"/> Listed on Hydric Soils List      |
| <input checked="" type="checkbox"/> Histic Epipedon            | <input type="checkbox"/> Fe/Mn Concretions                |
| <input type="checkbox"/> Sulfidic Odor                         | <input type="checkbox"/> Organic Streaking in Sandy Soils |
| <input type="checkbox"/> Aquic or Peraguc Moisture Regime      | <input type="checkbox"/> Mottles (Redoximorphic Features) |
| <input type="checkbox"/> Reducing Conditions                   | <input type="checkbox"/> Other (Explain in Remarks)       |
| <input type="checkbox"/> Gleyed or Low-Chroma Colors           |   |
| <input type="checkbox"/> High Organic Content in Surface Layer |   |

Remarks (Describe soil disturbances, local variations, etc.):  
*The A horizon is composed of organic matter. Low chroma soil color and high organic content indicate hydric soil.*

## WETLAND DETERMINATION

Hydrophytic Vegetation Present? Yes  No  Is this Sampling Point Within a Wetland?  
Hydric Soils Present? Yes  No  Yes  No   
Wetland Hydrology Present? Yes  No

Remarks  
*Wetland vegetation, hydrology, and soil criteria are met. Therefore, the sample plot is located in a wetland.*

Data Plot #: 29C-SP2  
 Wetland: Upland near 29C

## WETLAND DETERMINATION (Modified from: 1987 ACOE Wetlands Delineation Manual)

Project/Site: ELST Re-delineation Date: 11/8/2007 Revisited 03-20-14  
 Applicant/Owner: King County County: King County  
 Investigator: Laura Brock/Linda Krippner State: WA  
 1987 Method  1977 WA St. Method Community ID: Upland Forest  
 Do Normal Circumstances exist on the site? Yes X No \_\_\_\_\_ Field Plot ID: 29C-SP2  
 Is the site significantly disturbed (Atypical Situation)? Yes \_\_\_\_\_ No X  
 Is the area a potential Problem Area? Yes \_\_\_\_\_ No X

**Remarks** (Explain sample location, disturbances, problem areas):

*SP-2 is located on a slope approximately 20' north of Flag 29C-16.* 03-20-14 - SP is located on fill slope approximately 5 feet west of fence and 5 feet southwest of gate. North of bamboo.

**VEGETATION** (✓ Dominant species are checked)

Plant Species	% Cover	Stratum	Indicator
1. <u>Equisetum hyemale</u>	<u>trace</u>	<u>Herb</u>	<u>FACW</u>
✓ 2. <u>Equisetum telmateia</u>	<u>75</u>	<u>Herb</u>	<u>FACW</u>
3. <u>Bambusa vulgaris</u>	<u>15</u>	<u>Shrub</u>	<u>NL</u>
4. <u>Rubus spectabilis</u>	<u>15</u>	<u>Shrub</u>	<u>FAC+</u>
✓ 5. <u>Alnus rubra</u>	<u>30</u>	<u>Trace</u>	<u>FAC</u>

**03-20-14 Observations**  
 Equisetum hyemale 2%  
 Equisetum telmateia 75%  
 Hedera helix 10%  
 Bambusa vulgaris 30%  
 Rubus armeniacus 2%  
 Rubus spectabilis 35%  
 Acer macrophyllum 40%  
 Salix lucida (rooted in WL) 20%  
 Populus balsamifera (rooted in WL) 5%  
 Prunus laurocerasus 2%

Percent of **Dominant Species** that are OBL, FACW, or FAC (except FAC-). Include species noted (\*) as showing morphological adaptations to wetlands. "T" indicates trace. 75

**Remarks** (Describe disturbances, relevant local variations, seasonal effects, etc.):  
*The percent of dominant species that are hydrophytic is greater than 50 percent. Hydrophytic vegetation criterion is satisfied.*

**HYDROLOGY**

**Recorded Data** (Describe in Remarks):

\_\_\_\_\_ Stream, Lake, or Tide Gage  
 \_\_\_\_\_ Aerial Photograph  
 \_\_\_\_\_ Other  
X No Recorded Data Available

**Wetland Hydrology Indicators** (Describe in Remarks):

Primary Indicators:  
 \_\_\_\_\_ Inundated  
 \_\_\_\_\_ Saturated in Upper 12 inches  
 \_\_\_\_\_ Water Marks  
 \_\_\_\_\_ Drift Lines  
 \_\_\_\_\_ Sediment Deposits  
 \_\_\_\_\_ Drainage Patterns in Wetlands

**Field Observations:**

Depth of Surface Water: none (in.)  
 Depth to Free Water in Pit: none (in.)  
 Depth to Saturated Soil: none (in.)

Secondary Indicators (2 or more required):  
 \_\_\_\_\_ Oxidized Rhizospheres in Upper 12 inches  
 \_\_\_\_\_ Water-Stained Leaves  
 \_\_\_\_\_ Local Soil Survey Data  
 \_\_\_\_\_ Other (Explain in Remarks)

**Remarks** (As relevant, describe recent precipitation, hydrologic modifications, local variations, etc.):  
*No primary or secondary indicators of hydrology are present. Wetland hydrology criterion is not satisfied.*

# Parametrix

Data Plot #: 29C-SP2  
Wetland: Upland near 29C

Project/Site: ELST Re-delineation Date: 11/8/2007 Revisited 03-20-14

## SOIL

### Soil Survey Data:

Map Unit Name: Alderwood gravelly sandy loam, 15 to 30 % slopes Drainage Class: Moderately well drained  
Field Observations Confirm Mapped Type?

Taxonomy (Subgroup): Entic Durochrepts Yes  No  NA

### Profile Description:

Depth (Inches)	Horizon Designation	Matrix Color (Munsell Moist)	Mottle Color (Munsell Moist)	Mottle Abundance/Contrast	Texture, Concretions, Rhizospheres, etc.
0-16+					gravel fill

### Hydric Soil Indicators:

- |  |   |
|--|---|
| <input type="checkbox"/> Histosol                              | <input type="checkbox"/> Listed on Hydric Soils List      |
| <input type="checkbox"/> Histic Epipedon                       | <input type="checkbox"/> Fe/Mn Concretions                |
| <input type="checkbox"/> Sulfidic Odor                         | <input type="checkbox"/> Organic Streaking in Sandy Soils |
| <input type="checkbox"/> Aquic or Peraguc Moisture Regime      | <input type="checkbox"/> Mottles (Redoximorphic Features) |
| <input type="checkbox"/> Reducing Conditions                   | <input type="checkbox"/> Other (Explain in Remarks)       |
| <input type="checkbox"/> Gleyed or Low-Chroma Colors           |   |
| <input type="checkbox"/> High Organic Content in Surface Layer |   |

Remarks (Describe soil disturbances, local variations, etc.):  
*Gravel fill from trail bed. No hydric soil indicators are present.*

## WETLAND DETERMINATION

Hydrophytic Vegetation Present? Yes  No  Is this Sampling Point Within a Wetland?  
Hydric Soils Present? Yes  No  Yes  No   
Wetland Hydrology Present? Yes  No

Remarks  
*Hydric soil and hydrology criteria are not satisfied. Therefore, the sample plot is not in a wetland.*

Data Plot #: 29D-SP1  
Wetland: 29D

## WETLAND DETERMINATION (Modified from: 1987 ACOE Wetlands Delineation Manual)

Project/Site: ELST Re-delineation Date: 11/13/2007 Revisited 09-27-13  
Applicant/Owner: King County County: King  
Investigator: Chip Maney, Erik Christensen State: WA  
 1987 Method  1997 WA St. Method Community ID: PEM  
Do Normal Circumstances exist on the site? Yes X No \_\_\_\_\_ Field Plot ID: 29D-SP1  
Is the site significantly disturbed (Atypical Situation)? Yes \_\_\_\_\_ No X  
Is the area a potential Problem Area? Yes \_\_\_\_\_ No X

### Remarks (Explain sample location, disturbances, problem areas):

*This sample plot is located between flags 2 and 3 at the toe of the slope. Populus balsamifera are directly upslope and a Arbutus menziesii leans out over the trail 30 feet to the north.*

### VEGETATION (✓ Dominant species are checked)

	Plant Species	% Cover	Stratum	Indicator
1.	<u>Arbutus menziesii*</u>	<u>15</u>	<u></u>	<u>NL</u>
✓ 2.	<u>Equisetum telmateia</u>	<u>70</u>	<u>Herb</u>	<u>FACW</u>
✓ 3.	<u>Hedera helix</u>	<u>25</u>	<u>Herb</u>	<u>NL</u>
✓ 4.	<u>Scirpus microcarpus</u>	<u>50</u>	<u>Herb</u>	<u>OBL</u>
✓ 5.	<u>Corylus cornuta*</u>	<u>60</u>	<u>Shrub</u>	<u>FACU</u>
✓ 6.	<u>Populus balsamifera*</u>	<u>50</u>	<u>Tree</u>	<u>FAC</u>

Percent of **Dominant Species** that are OBL, FACW, or FAC (except FAC-). Include species noted (\*) as showing morphological adaptations to wetlands. "T" indicates trace. 100

### Remarks (Describe disturbances, relevant local variations, seasonal effects, etc.):

*\*Corylus cornuta, Populus balsamifera, and Arbutus menziesii were rooted outside of the wetland, but were hanging over to provide cover. Hydrophytic vegetation is dominate. Hydrophytic vegetation criterion is satisfied.*

### HYDROLOGY

#### Recorded Data (Describe in Remarks):

\_\_\_\_\_ Stream, Lake, or Tide Gage  
\_\_\_\_\_ Aerial Photograph  
\_\_\_\_\_ Other  
X No Recorded Data Available

#### Field Observations:

Depth of Surface Water: none (in.)  
Depth to Free Water in Pit: 9 (in.)  
Depth to Saturated Soil: surface (in.)

#### Wetland Hydrology Indicators (Describe in Remarks):

##### Primary Indicators:

\_\_\_\_\_ Inundated  
X Saturated in Upper 12 inches  
\_\_\_\_\_ Water Marks  
\_\_\_\_\_ Drift Lines  
\_\_\_\_\_ Sediment Deposits  
\_\_\_\_\_ Drainage Patterns in Wetlands

##### Secondary Indicators (2 or more required):

\_\_\_\_\_ Oxidized Rhizospheres in Upper 12 inches  
\_\_\_\_\_ Water-Stained Leaves  
\_\_\_\_\_ Local Soil Survey Data  
\_\_\_\_\_ Other (Explain in Remarks)

### Remarks (As relevant, describe recent precipitation, hydrologic modifications, local variations, etc.):

*Saturation in the upper 12 inches satisfies wetland hydrology criterion.*

**09-27-13 Observations** - Shallow inundation in ditch and active seeps.

# Parametrix

Data Plot #: 29D-SP1  
Wetland: 29D

Project/Site: ELST Re-delineation Date: 11/13/2007 Revisited 09-27-13

## SOIL

### Soil Survey Data:

Map Unit Name: Shalcar Muck Drainage Class: very poorly drained  
Field Observations Confirm Mapped Type?

Taxonomy (Subgroup): Terric Medisaprists Yes  No  NA

### Profile Description:

Depth (Inches)	Horizon Designation	Matrix Color (Munsell Moist)	Mottle Color (Munsell Moist)	Mottle Abundance/Contrast	Texture, Concretions, Rhizospheres, etc.
0-12	A	10YR 2/1	none	none	gravelly loam
12-16	A2	10YR 3/1	none	none	loamy sand

### Hydric Soil Indicators:

- |   |   |
|---|---|
| <input type="checkbox"/> Histosol                               | <input type="checkbox"/> Listed on Hydric Soils List      |
| <input type="checkbox"/> Histic Epipedon                        | <input type="checkbox"/> Fe/Mn Concretions                |
| <input type="checkbox"/> Sulfidic Odor                          | <input type="checkbox"/> Organic Streaking in Sandy Soils |
| <input type="checkbox"/> Aquic or Peraguc Moisture Regime       | <input type="checkbox"/> Mottles (Redoximorphic Features) |
| <input type="checkbox"/> Reducing Conditions                    | <input type="checkbox"/> Other (Explain in Remarks)       |
| <input checked="" type="checkbox"/> Gleyed or Low-Chroma Colors |   |
| <input type="checkbox"/> High Organic Content in Surface Layer  |   |

Remarks (Describe soil disturbances, local variations, etc.):  
*Low chroma soil matrix indicate hydric soils*

## WETLAND DETERMINATION

Hydrophytic Vegetation Present? Yes  No  Is this Sampling Point Within a Wetland?  
Hydric Soils Present? Yes  No  Yes  No   
Wetland Hydrology Present? Yes  No

### Remarks

*Wetland vegetation, hydrology, and soil criteria are met. Therefore, the sample plot is located in a wetland.*

# Parametrix

Data Plot #: 29D-SP2  
Wetland: Upland near 29D

## WETLAND DETERMINATION (Modified from: 1987 ACOE Wetlands Delineation Manual)

Project/Site: ELST Re-delineation Date: 11/13/2007 Revisited 09-27-13  
Applicant/Owner: King County County: King  
Investigator: Chip Maney State: WA  
 1987 Method  1997 WA St. Method Community ID: Upland Forest  
Do Normal Circumstances exist on the site? Yes X No \_\_\_\_\_ Field Plot ID: 29D-SP2  
Is the site significantly disturbed (Atypical Situation)? Yes \_\_\_\_\_ No X  
Is the area a potential Problem Area? Yes \_\_\_\_\_ No X

**Remarks** (Explain sample location, disturbances, problem areas):

*This sample plot is located directly upslope from sample plot 1 between flags 2 and 3.*

### VEGETATION (✓ Dominant species are checked)

Plant Species	% Cover	Stratum	Indicator
✓ 1. <u>Equisetum telmateia</u>	<u>40</u>	<u>Herb</u>	<u>FACW</u>
✓ 2. <u>Hedera helix</u>	<u>90</u>	<u>Herb</u>	<u>NL</u>
✓ 3. <u>Corylus cornuta</u>	<u>50</u>	<u>Shrub</u>	<u>FACU</u>
✓ 4. <u>Populus balsamifera</u>	<u>75</u>	<u>Tree</u>	<u>FAC</u>

Percent of **Dominant Species** that are OBL, FACW, or FAC (except FAC-). Include species noted (\*) as showing morphological adaptations to wetlands. "T" indicates trace. 67

**Remarks** (Describe disturbances, relevant local variations, seasonal effects, etc.):

*The percent of dominant species that are hydrophytic is greater than 50 percent. Hydrophytic vegetation criterion is satisfied.*

### HYDROLOGY

**Recorded Data** (Describe in Remarks):

\_\_\_\_\_ Stream, Lake, or Tide Gage  
\_\_\_\_\_ Aerial Photograph  
\_\_\_\_\_ Other  
X No Recorded Data Available

**Field Observations:**

Depth of Surface Water: none (in.)  
Depth to Free Water in Pit: none (in.)  
Depth to Saturated Soil: none (in.)

**Wetland Hydrology Indicators** (Describe in Remarks):

Primary Indicators:

\_\_\_\_\_ Inundated  
\_\_\_\_\_ Saturated in Upper 12 inches  
\_\_\_\_\_ Water Marks  
\_\_\_\_\_ Drift Lines  
\_\_\_\_\_ Sediment Deposits  
\_\_\_\_\_ Drainage Patterns in Wetlands

Secondary Indicators (2 or more required):

\_\_\_\_\_ Oxidized Rhizospheres in Upper 12 inches  
\_\_\_\_\_ Water-Stained Leaves  
\_\_\_\_\_ Local Soil Survey Data  
\_\_\_\_\_ Other (Explain in Remarks)

**Remarks** (As relevant, describe recent precipitation, hydrologic modifications, local variations, etc.):

*No indicators of wetland hydrology are present. Wetland hydrology criterion is not satisfied.*

# Parametrix

Data Plot #: 29D-SP2  
Wetland: Upland near 29D

Project/Site: ELST Re-delineation Date: 11/13/2007 Revisited 09-27-13

## SOIL

### Soil Survey Data:

Map Unit Name: Shalcar Muck Drainage Class: very poorly drained  
Field Observations Confirm Mapped Type?

Taxonomy (Subgroup): Terric Medisaprists Yes  No  NA

### Profile Description:

Depth (Inches)	Horizon Designation	Matrix Color (Munsell Moist)	Mottle Color (Munsell Moist)	Mottle Abundance/Contrast	Texture, Concretions, Rhizospheres, etc.
0-18	A	10YR 2/2	none	none	gravelly sandy loam

### Hydric Soil Indicators:

- |  |   |
|--|---|
| <input type="checkbox"/> Histosol                              | <input type="checkbox"/> Listed on Hydric Soils List      |
| <input type="checkbox"/> Histic Epipedon                       | <input type="checkbox"/> Fe/Mn Concretions                |
| <input type="checkbox"/> Sulfidic Odor                         | <input type="checkbox"/> Organic Streaking in Sandy Soils |
| <input type="checkbox"/> Aquic or Peraguc Moisture Regime      | <input type="checkbox"/> Mottles (Redoximorphic Features) |
| <input type="checkbox"/> Reducing Conditions                   | <input type="checkbox"/> Other (Explain in Remarks)       |
| <input type="checkbox"/> Gleyed or Low-Chroma Colors           |   |
| <input type="checkbox"/> High Organic Content in Surface Layer |   |

Remarks (Describe soil disturbances, local variations, etc.):  
*No indicators of hydric soils are present. Hydric soil criterion is not satisfied.*

## WETLAND DETERMINATION

Hydrophytic Vegetation Present? Yes  No  Is this Sampling Point Within a Wetland?  
Hydric Soils Present? Yes  No  Yes  No   
Wetland Hydrology Present? Yes  No

Remarks  
*Hydric soil and wetland hydrology criteria are not satisfied. Therefore, the sample plot is not located in a wetland.*



Data Plot #: 29D-SP3  
 Wetland: 29D

## WETLAND DETERMINATION (Modified from: 1987 ACOE Wetlands Delineation Manual)

Project/Site: ELST Re-delineation Date: 11/13/2007 Revisited 09-27-13  
 Applicant/Owner: King County County: King  
 Investigator: Chip Maney, Erik Christensen State: WA  
 1987 Method  1977 WA St. Method Community ID: PSS  
 Do Normal Circumstances exist on the site? Yes X No \_\_\_\_\_ Field Plot ID: 29D-SP3  
 Is the site significantly disturbed (Atypical Situation)? Yes \_\_\_\_\_ No X  
 Is the area a potential Problem Area? Yes \_\_\_\_\_ No X

**Remarks** (Explain sample location, disturbances, problem areas):

*This sample plot is located 20 feet downslope (south/southwest) of flags 10 and 11, and 10 feet east/northeast of an Alnus rubra with a rotted trunk.*

**VEGETATION** (✓ Dominant species are checked)

	Plant Species	% Cover	Stratum	Indicator
1.	<u>Athyrium filix-femina</u>	<u>5</u>	<u>Herb</u>	<u>FAC</u>
2.	<u>Ribes lacustre</u>	<u>15</u>	<u>Shrub</u>	<u>FAC+</u>
3.	<u>Rubus armeniacus</u>	<u>15</u>	<u>Shrub</u>	<u>FACU</u>
✓ 4.	<u>Rubus spectabilis</u>	<u>50</u>	<u>Shrub</u>	<u>FAC+</u>
✓ 5.	<u>Alnus rubra</u>	<u>50</u>	<u>Tree</u>	<u>FAC</u>

Percent of **Dominant Species** that are OBL, FACW, or FAC (except FAC-). Include species noted (\*) as showing morphological adaptations to wetlands. "T" indicates trace. 100

**Remarks** (Describe disturbances, relevant local variations, seasonal effects, etc.):

*The percent of dominant species that are hydrophytic is greater than 50 percent. Hydrophytic vegetation criterion is satisfied.*

**HYDROLOGY**

**Recorded Data** (Describe in Remarks):

\_\_\_\_\_ Stream, Lake, or Tide Gage  
 \_\_\_\_\_ Aerial Photograph  
 \_\_\_\_\_ Other  
X No Recorded Data Available

**Wetland Hydrology Indicators** (Describe in Remarks):

Primary Indicators:

\_\_\_\_\_ Inundated  
X Saturated in Upper 12 inches  
 \_\_\_\_\_ Water Marks  
 \_\_\_\_\_ Drift Lines  
 \_\_\_\_\_ Sediment Deposits  
 \_\_\_\_\_ Drainage Patterns in Wetlands

**Field Observations:**

Depth of Surface Water: none (in.)  
 Depth to Free Water in Pit: 10 (in.)  
 Depth to Saturated Soil: surface (in.)

Secondary Indicators (2 or more required):

\_\_\_\_\_ Oxidized Rhizospheres in Upper 12 inches  
 \_\_\_\_\_ Water-Stained Leaves  
 \_\_\_\_\_ Local Soil Survey Data  
 \_\_\_\_\_ Other (Explain in Remarks)

**Remarks** (As relevant, describe recent precipitation, hydrologic modifications, local variations, etc.):

*Saturation in the upper 12 inches satisfies wetland hydrology criterion.*

# Parametrix

Data Plot #: 29D-SP3  
Wetland: 29D

Project/Site: ELST Re-delineation Date: 11/13/2007 Revisited 09-27-13

## SOIL

### Soil Survey Data:

Map Unit Name: Shalcar Muck Drainage Class: very poorly drained  
Field Observations Confirm Mapped Type?

Taxonomy (Subgroup): Terric Medisaprists Yes  No  NA

### Profile Description:

Depth (Inches)	Horizon Designation	Matrix Color (Munsell Moist)	Mottle Color (Munsell Moist)	Mottle Abundance/Contrast	Texture, Concretions, Rhizospheres, etc.
0-18	A	10YR 2/1	none	none	mucky loam

### Hydric Soil Indicators:

- |   |   |
|---|---|
| <input type="checkbox"/> Histosol                               | <input type="checkbox"/> Listed on Hydric Soils List      |
| <input type="checkbox"/> Histic Epipedon                        | <input type="checkbox"/> Fe/Mn Concretions                |
| <input type="checkbox"/> Sulfidic Odor                          | <input type="checkbox"/> Organic Streaking in Sandy Soils |
| <input type="checkbox"/> Aquic or Peraguc Moisture Regime       | <input type="checkbox"/> Mottles (Redoximorphic Features) |
| <input type="checkbox"/> Reducing Conditions                    | <input type="checkbox"/> Other (Explain in Remarks)       |
| <input checked="" type="checkbox"/> Gleyed or Low-Chroma Colors |   |
| <input type="checkbox"/> High Organic Content in Surface Layer  |   |

Remarks (Describe soil disturbances, local variations, etc.):  
*Low chroma indicats hydric soils.*

## WETLAND DETERMINATION

Hydrophytic Vegetation Present? Yes  No  Is this Sampling Point Within a Wetland?  
Hydric Soils Present? Yes  No  Yes  No   
Wetland Hydrology Present? Yes  No

### Remarks

*Wetland vegetation, hydrology, and soil criteria are met. Therefore, the sample plot is located in a wetland.*

Data Plot #: 30B-SP1  
 Wetland: 30B

## WETLAND DETERMINATION (Modified from: 1987 ACOE Wetlands Delineation Manual)

Project/Site: ELST Re-delineation Date: 1/11/2008 Revisited 09-27-13  
 Applicant/Owner: King County County: King  
 Investigator: Matt Maynard, Erik Christensen State: WA  
 1987 Method  1997 WA St. Method Community ID: PSS 09-27-13 - PFO  
 Do Normal Circumstances exist on the site? Yes X No \_\_\_\_\_ Field Plot ID: 30B-SP1  
 Is the site significantly disturbed (Atypical Situation)? Yes \_\_\_\_\_ No X  
 Is the area a potential Problem Area? Yes \_\_\_\_\_ No X

**Remarks** (Explain sample location, disturbances, problem areas):  
*This sample plot is located 12 feet northwest of the boardwalk and north of the large woody debris.*

### VEGETATION (✓ Dominant species are checked)

	Plant Species	% Cover	Stratum	Indicator
1.	<u>Athyrium filix-femina</u>	<u>5</u>	<u>Herb</u>	<u>FAC</u>
✓ 2.	<u>Equisetum telmateia</u>	<u>25</u>	<u>Herb</u>	<u>FACW</u>
3.	<u>Oenanthe sarmentosa</u>	<u>5</u>	<u>Herb</u>	<u>OBL</u>
✓ 4.	<u>Phalaris arundinacea</u>	<u>70</u>	<u>Herb</u>	<u>FACW</u>
✓ 5.	<u>Solanum dulcamara</u>	<u>40</u>	<u>Herb</u>	<u>FAC+</u>
6.	<u>Cornus sericea</u>	<u>15</u>	<u>Shrub</u>	<u>FACW</u>
7.	<u>Rubus armeniacus</u>	<u>trace</u>	<u>Shrub</u>	<u>FACU</u>
8.	<u>Salix spp.</u>	<u>15</u>	<u>Shrub</u>	_____
✓ 9.	<u>Alnus rubra</u>	<u>35</u>	<u>Tree</u>	<u>FAC</u>

**09-27-13 Observations**  
 Athyrium filix-femina 5%  
 Phalaris arundinacea 5%  
 Solanum dulcamara trace  
 Cornus sericea 20%  
 Rubus armeniacus trace  
 Alnus rubra 70%  
 Physocarpus capitatus 55%  
 Rubus spectabilis 10%  
 Lonicera involucrata 15%

Percent of **Dominant Species** that are OBL, FACW, or FAC (except FAC-). Include species noted (\*) as showing morphological adaptations to wetlands. "T" indicates trace. 100

**Remarks** (Describe disturbances, relevant local variations, seasonal effects, etc.):  
*The percent of dominant species that are hydrophytic is greater than 50 percent. Hydrophytic vegetation criterion is satisfied.*

### HYDROLOGY

**Recorded Data** (Describe in Remarks):  
 \_\_\_\_\_ Stream, Lake, or Tide Gage  
 \_\_\_\_\_ Aerial Photograph  
 \_\_\_\_\_ Other  
X No Recorded Data Available

**Wetland Hydrology Indicators** (Describe in Remarks):

Primary Indicators:  
 \_\_\_\_\_ Inundated  
X Saturated in Upper 12 inches  
 \_\_\_\_\_ Water Marks  
 \_\_\_\_\_ Drift Lines  
 \_\_\_\_\_ Sediment Deposits  
 \_\_\_\_\_ Drainage Patterns in Wetlands

**Field Observations:**

Depth of Surface Water: none (in.)  
 Depth to Free Water in Pit: 15 (in.)  
 Depth to Saturated Soil: surface (in.)

Secondary Indicators (2 or more required):  
 \_\_\_\_\_ Oxidized Rhizospheres in Upper 12 inches  
 \_\_\_\_\_ Water-Stained Leaves  
 \_\_\_\_\_ Local Soil Survey Data  
 \_\_\_\_\_ Other (Explain in Remarks)

**Remarks** (As relevant, describe recent precipitation, hydrologic modifications, local variations, etc.):  
*Saturation in the upper 12 inches satisfies wetland hydrology criterion.*

**09-27-13 Observations** - Soil saturation to the surface. Drainage channel with flowing water (flowing north) near sample plot.

# Parametrix

Data Plot #: 30B-SP1  
Wetland: 30B

Project/Site: ELST Re-delineation

Date: 1/11/2008

Revisited 09-27-13

## SOIL

### Soil Survey Data:

Map Unit Name: Alderwood gravelly sandy loam 15 to 30% slopes

Drainage Class: Moderately well drained

Field Observations Confirm Mapped Type?

Taxonomy (Subgroup): Dystric Durochrepts

Yes  No  NA

### Profile Description:

Depth (Inches)	Horizon Designation	Matrix Color (Munsell Moist)	Mottle Color (Munsell Moist)	Mottle Abundance/Contrast	Texture, Concretions, Rhizospheres, etc.
0-5	A1	10YR 2/1	none	none	silt loam
5-10	A2	10YR 3/1	none	none	sandy gravelly loam
10-17	A2	7.5YR 2.5	none	none	muck

### Hydric Soil Indicators:

- |   |   |
|---|---|
| <input type="checkbox"/> Histosol                               | <input type="checkbox"/> Listed on Hydric Soils List      |
| <input type="checkbox"/> Histic Epipedon                        | <input type="checkbox"/> Fe/Mn Concretions                |
| <input type="checkbox"/> Sulfidic Odor                          | <input type="checkbox"/> Organic Streaking in Sandy Soils |
| <input type="checkbox"/> Aquic or Peraguic Moisture Regime      | <input type="checkbox"/> Mottles (Redoximorphic Features) |
| <input type="checkbox"/> Reducing Conditions                    | <input type="checkbox"/> Other (Explain in Remarks)       |
| <input checked="" type="checkbox"/> Gleyed or Low-Chroma Colors |   |
| <input type="checkbox"/> High Organic Content in Surface Layer  |   |

Remarks (Describe soil disturbances, local variations, etc.):

*Low-chroma soil matrix colors indicates hydric soils.*

## WETLAND DETERMINATION

Hydrophytic Vegetation Present? Yes  No

Hydric Soils Present? Yes  No

Wetland Hydrology Present? Yes  No

Is this Sampling Point Within a Wetland?

Yes  No

### Remarks

*Wetland vegetation, hydrology, and soil criteria are met. Therefore, the sample plot is located in a wetland.*

Exhibit 16  
SSDP2016-00415  
000959

Data Plot #: 30B-SP2  
 Wetland: Upland near 30B

## WETLAND DETERMINATION (Modified from: 1987 ACOE Wetlands Delineation Manual)

Project/Site: ELST Re-delineation Date: 1/11/2008 Revisited 09-27-13  
 Applicant/Owner: King County County: King  
 Investigator: Matt Maynard, Erik Christensen State: WA

1987 Method  1997 WA St. Method Community ID: Upland Shrubs 09-27-13 - Forest

Do Normal Circumstances exist on the site? Yes X No \_\_\_\_\_ Field Plot ID: 30B-SP2  
 Is the site significantly disturbed (Atypical Situation)? Yes \_\_\_\_\_ No X  
 Is the area a potential Problem Area? Yes \_\_\_\_\_ No X

**Remarks** (Explain sample location, disturbances, problem areas):  
*This sample plot is located 6 feet north of flag W30B-14.*

### VEGETATION (✓ Dominant species are checked)

	Plant Species	% Cover	Stratum	Indicator
1.	<u>Equisetum telmateia</u>	<u>10</u>	<u>Herb</u>	<u>FACW</u>
2.	<u>Polystichum munitum</u>	<u>5</u>	<u>Herb</u>	<u>FACU</u>
3.	<u>Rubus armeniacus</u>	<u>10</u>	<u>Shrub</u>	<u>FACU</u>
✓ 4.	<u>Rubus spectabilis</u>	<u>60</u>	<u>Shrub</u>	<u>FAC+</u>
5.	<u>Rubus ursinus</u>	<u>5</u>	<u>Shrub</u>	<u>FACU</u>
6.	<u>Acer macrophyllum</u>	<u>10</u>	<u>Tree</u>	<u>FACU</u>

### 09-27-13 Observations

Equisetum telmateia 10%  
 Polystichum munitum 5%  
 Rubus armeniacus 50%  
 Rubus spectabilis 60%  
 Rubus ursinus 5%  
 Acer macrophyllum 70%  
 Fraxinus latifolia 5%

Percent of **Dominant Species** that are OBL, FACW, or FAC (except FAC-). Include species noted (\*) as showing morphological adaptations to wetlands. "T" indicates trace. 100

**Remarks** (Describe disturbances, relevant local variations, seasonal effects, etc.):  
*The percent of dominant species that are hydrophytic is greater than 50 percent. Hydrophytic vegetation criterion is satisfied.*

### HYDROLOGY

#### Recorded Data (Describe in Remarks):

\_\_\_\_\_ Stream, Lake, or Tide Gage  
 \_\_\_\_\_ Aerial Photograph  
 \_\_\_\_\_ Other  
X No Recorded Data Available

#### Wetland Hydrology Indicators (Describe in Remarks):

Primary Indicators:  
 \_\_\_\_\_ Inundated  
 \_\_\_\_\_ Saturated in Upper 12 inches  
 \_\_\_\_\_ Water Marks  
 \_\_\_\_\_ Drift Lines  
 \_\_\_\_\_ Sediment Deposits  
 \_\_\_\_\_ Drainage Patterns in Wetlands

#### Field Observations:

Depth of Surface Water: none (in.)  
 Depth to Free Water in Pit: none (in.)  
 Depth to Saturated Soil: none (in.)

Secondary Indicators (2 or more required):  
 \_\_\_\_\_ Oxidized Rhizospheres in Upper 12 inches  
 \_\_\_\_\_ Water-Stained Leaves  
 \_\_\_\_\_ Local Soil Survey Data  
 \_\_\_\_\_ Other (Explain in Remarks)

**Remarks** (As relevant, describe recent precipitation, hydrologic modifications, local variations, etc.):  
*No indicators of wetland hydrology are present. Wetland hydrology criterion is not satisfied.*

# Parametrix

Data Plot #: 30B-SP2  
Wetland: Upland near 30B

Project/Site: ELST Re-delineation Date: 1/11/2008 Revisited 09-27-13

## SOIL

### Soil Survey Data:

Map Unit Name: Alderwood gravelly sandy loam, 15 to 30 % slopes Drainage Class: Moderately well drained  
Field Observations Confirm Mapped Type?

Taxonomy (Subgroup): Dystric Durochrepts Yes  No  NA

### Profile Description:

Depth (Inches)	Horizon Designation	Matrix Color (Munsell Moist)	Mottle Color (Munsell Moist)	Mottle Abundance/Contrast	Texture, Concretions, Rhizospheres, etc.
0-16	A	7.5YR 2.5/2	none	none	gravelly sandy loam

### Hydric Soil Indicators:

- |  |   |
|--|---|
| <input type="checkbox"/> Histosol                              | <input type="checkbox"/> Listed on Hydric Soils List      |
| <input type="checkbox"/> Histic Epipedon                       | <input type="checkbox"/> Fe/Mn Concretions                |
| <input type="checkbox"/> Sulfidic Odor                         | <input type="checkbox"/> Organic Streaking in Sandy Soils |
| <input type="checkbox"/> Aquic or Peraguc Moisture Regime      | <input type="checkbox"/> Mottles (Redoximorphic Features) |
| <input type="checkbox"/> Reducing Conditions                   | <input type="checkbox"/> Other (Explain in Remarks)       |
| <input type="checkbox"/> Gleyed or Low-Chroma Colors           |   |
| <input type="checkbox"/> High Organic Content in Surface Layer |   |

Remarks (Describe soil disturbances, local variations, etc.):  
*No indicators of hydric soil are present. Hydric soil criterion is not satisfied.*

## WETLAND DETERMINATION

Hydrophytic Vegetation Present? Yes  No  Is this Sampling Point Within a Wetland?  
Hydric Soils Present? Yes  No  Yes  No   
Wetland Hydrology Present? Yes  No

Remarks  
*Wetland vegetation, hydrology, and soil criteria are not met. Therefore, the sample plot is not located in a wetland.*

# APPENDIX B

## Wetland Rating Forms

Wetland name or number 15A

**WETLAND RATING FORM – WESTERN WASHINGTON**  
Version 2 – Updated July 2006 to increase accuracy and reproducibility among users  
Updated Oct. 2008 with the new WDFW definitions for priority habitats

Name of wetland (if known): 15A Date of site visit: 05-05-09 (rev: 03-11-14)

Rated by: Colin Worsley / Matt Maynard Trained by Ecology? Yes  No  Date of training: 11- 2005 / 04-2006

SEC: 07 TOWNSHIP: 24N RANGE: 06E Is S/T/R in Appendix D? Yes  No

Map of wetland unit: Figure \_\_\_\_\_ Estimated size ~0.50 acre

**SUMMARY OF RATING**

Category based on FUNCTIONS provided by wetland: I \_\_\_\_\_ II \_\_\_\_\_ III X IV \_\_\_\_\_

Category I =	Score > 70
Category II =	Score 51 - 69
Category III =	Score 30 – 50
Category IV =	Score < 30

Score for Water Quality Functions	18
Score for Hydrologic Functions	8
Score for Habitat Functions	16
<b>TOTAL Score for Functions</b>	<b>42</b>

Category based on SPECIAL CHARACTERISTICS of Wetland I \_\_\_\_\_ II \_\_\_\_\_ Does not apply X

**Final Category** (choose the “highest” category from above”) **III**

**Summary of basic information about the wetland unit.**

Wetland Unit has Special Characteristics		Wetland HGM Class used for Rating	
Estuarine		Depressional	
Natural Heritage Wetland		Riverine	
Bog		Lake-fringe	<b>X</b>
Mature Forest		Slope	<b>(x)</b>
Old Growth Forest		Flats	
Coastal Lagoon		Freshwater Tidal	
Interdunal			
None of the above	<b>X</b>	Check if unit has multiple HGM classes present	<b>X</b>

**Does the wetland being rated meet any of the criteria below?** If you answer YES to any of the questions below you will need to protect the wetland according to the regulations regarding the special characteristics found in the wetland.

Check List for Wetlands that Need Additional Protection (in addition to the protection recommended for its category)	YES	NO
SP1. <i>Has the wetland unit been documented as a habitat for any Federally listed Threatened or Endangered <b>animal or plant</b> species (T/E species)?</i> For the purposes of this rating system, “documented” means the wetland is on the appropriate state or federal database.		X
SP2. <i>Has the wetland unit been documented as habitat for any State listed Threatened or Endangered <b>animal</b> species?</i> For the purposes of this rating system, “documented” means the wetland is on the appropriate state database. Note: Wetlands with State listed plant species are categorized as Category 1 Natural Heritage Wetlands (see p. 19 of data form).		X
SP3. <i>Does the wetland unit contain individuals of Priority species listed by the WDFW for the state?</i>		X
SP4. <i>Does the wetland unit have a local significance in addition to its functions?</i> For example, the wetland has been identified in the Shoreline Master Program, the Critical Areas Ordinance, or in a local management plan as having special significance.		X

To complete the next part of the data sheet you will need to determine the Hydrogeomorphic Class of the wetland being rated.

Exhibit 16  
SSDP2016-00415  
000903



### Classification of Vegetated Wetlands for Western Washington

If the hydrologic criteria listed in each question do not apply to the entire unit being rated, you probably have a unit with multiple HGM classes. In this case, identify which hydrologic criteria in questions 1-7 apply, and go to Question 8.

1. Are the water levels in the entire unit usually controlled by tides (i.e. except during floods)?  
NO – go to 2                      **YES – the wetland class is Tidal Fringe**  
 If yes, is the salinity of the water during periods of annual low flow below 0.5 ppt (parts per thousand)?  
**YES – Freshwater Tidal Fringe**                      **NO – Saltwater Tidal Fringe (Estuarine)**  
*If your wetland can be classified as a Freshwater Tidal Fringe use the forms for Riverine wetlands. If it is a Saltwater Tidal Fringe it is rated as an Estuarine wetland. Wetlands that were call estuarine in the first and second editions of the rating system are called Salt Water Tidal Fringe in the Hydrogeomorphic Classification. Estuarine wetlands were categorized separately in the earlier editions, and this separation is being kept in this revision. To maintain consistency between editions, the term “Estuarine” wetland is kept. Please note, however, that the characteristics that define Category I and II estuarine wetlands have changed (see p. \_\_\_\_).*

---

2. The entire wetland unit is flat and precipitation is only source (>90%) of water to it. Groundwater and surface water runoff are NOT sources of water to the unit.  
NO – go to 3                      **YES – The wetland class is Flats**  
 If your wetland can be classified as a “Flats” wetland, use the form for **Depressional** wetlands.

---

3. Does the entire wetland meet both of the following criteria?  
 \_\_\_\_ The vegetated part of the wetland is on the shores of a body of permanent open water (without any vegetation on the surface) where at least 20 acres (8ha) in size;  
 \_\_\_\_ At least 30% of the open water area is deeper than 6.6 (2 m)?  
NO – go to 4                      **YES – The wetland class is Lake-fringe (Lacustrine Fringe)**

---

4. Does the entire wetland meet all of the following criteria?  
 \_\_\_\_ The wetland is on a slope (*slope can be very gradual*).  
 \_\_\_\_ The water flows through the wetland in one direction (unidirectional) and usually comes from seeps. It may flow subsurface, as sheetflow, or in a swale without distinct banks.  
 \_\_\_\_ The water leaves the wetland **without being impounded**?  
 NOTE: *Surface water does not pond in these types of wetlands except occasionally in very small and shallow depressions or behind hummocks (depressions are usually <3 ft diameter and less than 1 foot deep).*  
NO – go to 5                      **YES – The wetland class is Slope**

---

5. Does the entire wetland meet all of the following criteria?  
 \_\_\_\_ The unit is in a valley or stream channel where it gets inundated by overbank flooding from that stream or river.  
 \_\_\_\_ The overbank flooding occurs at least once every two years.  
 NOTE: *The riverine unit can contain depressions that are filled with water when the river is not flooding..*  
NO – go to 6                      **YES – The wetland class is Riverine**

---

6. Is the entire wetland unit in a topographic depression in which water ponds, or is saturated to the surface, at some time of the year. This means that any outlet, if present is higher than the interior of the wetland.  
NO – go to 7                      **YES – The wetland class is Depressional**

---

7. Is the entire wetland located in a very flat area with no obvious depression and no overbank flooding. The unit does not pond surface water more than a few inches. The unit seems to be maintained by high groundwater in the area. The wetland may be ditched, but has no obvious natural outlet.  
No – go to 8                      **YES – The wetland class is Depressional**

---

8. Your wetland unit seems to be difficult to classify and probably contains several different HGM classes. For example, seeps at the base of a slope may grade into a riverine floodplain, or a small stream within a depressional wetland has a zone of flooding along its sides. **GO BACK AND IDENTIFY WHICH OF THE HYDROLOGIC REGIMES DESCRIBED IN QUESTIONS 1-7 APPLY TO DIFFERENT AREAS IN THE UNIT** (make a rough sketch to help you decide). Use the following table to identify the appropriate class to use for the rating system if you have several HGM classes present within your wetland. NOTE: Use this table only if the class that is recommended in the second column represents 10% or more of the total area of the wetland unit being rated. If the area of the class listed in column 2 is less than 10% of the unit, classify the wetland using the class that represents more than 90% of the total area.

HGM Classes within the wetland unit being rated	HGM Class to Use in Rating
Slope + Riverine	Riverine
Slope + Depressional	Depressional
Slope + Lake-fringe	Lake-fringe
Depressional + Riverine along stream within boundary	Depressional
Depressional + Lake-fringe	Depressional
Salt Water Tidal Fringe and any other class of freshwater wetland	Treat as ESTUARINE under wetlands with special characteristics

**Exhibit 16**  
**SSDP2016-00415**  
**000964**

If you are unable still to determine which of the above criteria apply to your wetland, or you have more than 2 HGM classes within a wetland boundary, classify the wetland as **Depressional** for the rating.

<b>L Lake-fringe Wetlands</b>		<b>Points</b>
<b>WATER QUALITY FUNCTIONS – Indicators that the wetland unit functions to improve water quality.</b>		(only 1 score per box)
<b>L 1</b>	<b>Does the wetland unit have the <u>potential</u> to improve water quality? (see p.59)</b>	
	L 1.1 Average width of vegetation along the lakeshore (use polygons of Cowardin classes): • Vegetation is more than 33 ft. (10m) wide ..... points = 6 • Vegetation is more than 16 ft.(5m) wide and < 33 ft ..... points = 3 • Vegetation is more than 6 ft. (2m) wide and < 16 ft ..... points = 1 • Vegetation is less than 6 ft. wide..... points = 0 <b>Map of Cowardin classes with widths marked</b>	Figure ____ 6
	L 1.2 Characteristics of the vegetation in the wetland: <i>Choose the appropriate description that results in the highest points, and do not include any open water in your estimate of coverage. The herbaceous plants can be either the dominant form or as an understory in a shrub or forest community. These are not Cowardin classes. Area of Cover is total cover in the unit, but it can be in patches. NOTE: Herbaceous does not include aquatic bed.</i> • Cover of herbaceous plants is > 90% of the vegetated area..... points = 6 • Cover of herbaceous plants is > 2/3 of the vegetated area..... points = 4 • Cover of herbaceous plants is > 1/3 of the vegetated area..... points = 3 • Other vegetation that is not aquatic bed or herbaceous covers > 2/3 of the unit ..... points = 3 • Other vegetation that is not aquatic bed in > 1/3 vegetated area ..... points = 1 • Aquatic bed cover and open water > 2/3 of the unit..... points = 0 <b>Map with polygons of different vegetation types</b>	Figure ____ 3
<i>Add the points in the boxes above</i>		<b>9</b>
<b>L 2</b>	<b>Does the wetland have the <u>opportunity</u> to improve water quality?</b>	(see p.61)
	Answer YES if you know or believe there are pollutants in the lake water, or polluted surface water flowing through the unit to the lake. <i>Note which of the following conditions provide the sources of pollutants. A unit may have pollutants coming from several sources, but any single source would qualify as opportunity.</i> ___ Wetland is along the shores of a lake or reservoir that does not meet water quality standards ___ Grazing in the wetland or within 150 ft ___ Polluted water discharges to wetland along upland edge ___ Tilled fields or orchards within 150 ft. of wetland <input checked="" type="checkbox"/> Residential or urban areas are within 150 ft. of wetland ___ Parks with grassy areas that are maintained, ballfields, golf courses (all within 150 ft. of lake shore) <input checked="" type="checkbox"/> Power boats with gasoline or diesel engines use the lake ___ Other _____ YES multiplier is 2 NO multiplier is 1	Multiplier X2
<b>◆</b>	<b>TOTAL – Water Quality Functions</b> Multiply the score from L1 by L2; then <i>add score to table on p. 1</i>	18
<b>HYDROLOGIC FUNCTIONS – Indicators that wetland functions to reduce shoreline erosion.</b>		
<b>L 3</b>	<b>Does the wetland have the <u>potential</u> to reduce shoreline erosion?</b>	(see p.62)
	L 3 Average width and characteristics of vegetation along the lakeshore ( <i>do not include aquatic bed</i> ): ( <i>choose the highest scoring description that matches conditions in the wetland</i> ) • 3/4 of distance is shrubs or forest at least 33 ft. (10m) wide ..... points = 6 • 3/4 of distance is shrubs or forest at least 6 ft. (2m) wide..... points = 4 • 1/4 of distance is shrubs or forest at least 33 ft. (10m) wide..... points = 4 • Vegetation is at least 6 ft. (2m) wide (any type except aquatic bed)..... points = 2 • Vegetation is less than 6 ft. (2m) wide (any type except aquatic bed) ..... points = 0 <b>Aerial photo or map with Cowardin vegetation classes</b>	Figure ____ 4
<i>Record the points in the boxes above</i>		4
<b>L 4</b>	<b>Does the wetland have the <u>opportunity</u> to reduce erosion?</b>	(see p. 64)
	Are there features along the shore that will be impacted if the shoreline erodes? <i>Note which of the following conditions apply.</i> <input checked="" type="checkbox"/> There are human structures and activities along the upland edge of the wetland (buildings, fields) that can be damaged by erosion. ___ There are undisturbed natural resources along the upland edge of the wetland (e.g. mature forests, other wetlands) that can be damaged by shoreline erosion. ___ Other _____ YES multiplier is 2 NO multiplier is 1	Multiplier X2
<b>◆</b>	<b>TOTAL – Hydrologic Functions</b> Multiply the score from L3 by L4; then <i>add score to table on p. 1</i>	8

Comments: Majority of herbaceous vegetation is maintained lawn.





These questions apply to wetlands of all HGM classes.		Points
HABITAT FUNCTIONS – Indicators that wetland functions to provide important habitat.		(only 1 score per box)
<b>H 1</b>	<b>Does the wetland have the potential to provide habitat for many species?</b>	
H 1.1	<p><u>Vegetation structure</u> (see P. 72):                      Check the types of vegetation classes present (as defined by Cowardin) – Size threshold for each class is 1/4 acre or more than 10% of the area if unit is smaller than 2.5 acres.</p> <p><input type="checkbox"/> Aquatic Bed  <input checked="" type="checkbox"/> Emergent plants  <input type="checkbox"/> Scrub/shrub (areas where shrubs have &gt; 30% cover)  <input checked="" type="checkbox"/> Forested (areas where trees have &gt; 30% cover)                      If the unit has a forested class check if:  <input checked="" type="checkbox"/> The forested class has 3 out of 5 strata (canopy, sub-canopy, shrubs, herbaceous, moss/ground-cover) that each cover 20% within the forested polygon.                      Add the number of vegetation types that qualify. If you have:</p> <p style="text-align: right;"><b>Map of Cowardin vegetation classes</b></p> <p style="text-align: right;">4 structures or more..... points = 4                      3 structures..... points = 2                      2 structures..... points = 1                      1 structure..... points = 0</p>	<p>Figure ____</p> <p style="text-align: right;">2</p>
H 1.2	<p><u>Hydroperiods</u> (see p.73):                      Check the types of water regimes (hydroperiods) present within the wetland. The water regime has to cover more than 10% of the wetland or 1/4 acre to count (see text for descriptions of hydroperiods).</p> <p><input type="checkbox"/> Permanently flooded or inundated  <input type="checkbox"/> Seasonally flooded or inundated  <input type="checkbox"/> Occasionally flooded or inundated  <input type="checkbox"/> Saturated only  <input type="checkbox"/> Permanently flowing stream or river in, or adjacent to, the wetland  <input type="checkbox"/> Seasonally flowing stream in, or adjacent to, the wetland  <input checked="" type="checkbox"/> Lake-fringe wetland..... = 2 points  <input type="checkbox"/> Freshwater tidal wetland..... = 2 points</p> <p style="text-align: right;"><b>Map of hydroperiods</b></p>	<p>Figure ____</p> <p style="text-align: right;">2</p>
H 1.3	<p><u>Richness of Plant Species</u> (see p. 75):                      Count the number of plant species in the wetland that cover at least 10 ft<sup>2</sup> (different patches of the same species can be combined to meet the size threshold)                      You do not have to name the species. Do not include Eurasian Milfoil, reed canarygrass, purple loosestrife, Canadian Thistle.</p> <p style="text-align: right;">If you counted: &gt; 19 species ..... points = 2                      5 – 19 species..... points = 1                      &lt; 5 species ..... points = 0</p> <p>List species below if you want to:                      _____                      _____                      _____</p>	<p>Figure ____</p> <p style="text-align: right;">1</p>
H 1.4	<p><u>Interspersion of Habitats</u> (see p. 76):                      Decided from the diagrams below whether interspersion between Cowardin vegetation (described in H1.1), or the classes and unvegetated areas (can include open water or mudflats) is high, medium, low, or none.</p> <div style="display: flex; justify-content: space-around;"> <div style="text-align: center;">  <p>None = 0 points</p> </div> <div style="text-align: center;">  <p>Low = 1 point</p> </div> <div style="text-align: center;">  <p>Moderate = 2 points</p> </div> <div style="text-align: center;">  <p>High = 3 points</p> </div> </div> <p style="text-align: center;">[riparian braided channels]</p> <p style="text-align: right;">Note: If you have 4 or more classes or 3 vegetation classes and open water, the rating is always “high”.</p> <p style="text-align: right;"><b>Use map of Cowardin classes.</b></p>	<p>Figure ____</p> <p style="text-align: right;">2</p>
H 1.5	<p><u>Special Habitat Features</u> (see p. 77):                      Check the habitat features that are present in the wetland. The number of checks is the number of points you put into the next column.</p> <p><input type="checkbox"/> Large, downed, woody debris within the wetland (&gt; 4 in. diameter and 6 ft. long)  <input type="checkbox"/> Standing snags (diameter at the bottom &gt; 4 inches) in the wetland  <input type="checkbox"/> Undercut banks are present for at least 6.6 ft. (2m) and/or overhanging vegetation extends at least 3.3 ft. (1m) over a stream (or ditch) in, or contiguous with the unit, for at least 33 ft. (10m)  <input type="checkbox"/> Stable steep banks of fine material that might be used by beaver or muskrat for denning (&gt; 30 degree slope) OR signs of recent beaver activity are present (cut shrubs or trees that have not yet turned grey/brown)  <input type="checkbox"/> At least 1/4 acre of thin-stemmed persistent vegetation or woody branches are present in areas that are permanently or seasonally inundated (structures for egg-laying by amphibians)  <input type="checkbox"/> Invasive plants cover less than 25% of the wetland area in each stratum of plants                      NOTE: The 20% stated in early printings of the manual on page 78 is an error.</p>	<p style="text-align: right;">0</p>
<b>H 1 TOTAL Score – potential for providing habitat</b>		<p>Add the points in the column above</p> <p style="text-align: right;">7</p>

Exhibit 16  
 SSP 2015-00215  
 000966

<b>H 2</b>	<b>Does the wetland have the <u>opportunity</u> to provide habitat for many species?</b>	(only 1 score per box)
	<p>H 2.1 <b>Buffers</b> (see P. 80):  Choose the description that best represents condition of buffer of wetland unit. The highest scoring criterion that applies to the wetland is to be used in the rating. See text for definition of "undisturbed".</p> <p><input type="checkbox"/> 100m (330 ft) of relatively undisturbed vegetated areas, rocky areas, or open water &gt; 95% of circumference. No structures are within the undisturbed part of buffer (relatively undisturbed also means no grazing, no landscaping, no daily human use)..... <b>points = 5</b></p> <p><input type="checkbox"/> 100m (330 ft) of relatively undisturbed vegetated areas, rocky areas, or open water &gt; 50% circumference ..... <b>points = 4</b></p> <p><input type="checkbox"/> 50m (170 ft) of relatively undisturbed vegetated areas, rocky areas, or open water &gt; 95% circumference ..... <b>points = 4</b></p> <p><input type="checkbox"/> 100m (330 ft) of relatively undisturbed vegetated areas, rocky areas, or open water &gt; 25% circumference ..... <b>points = 3</b></p> <p><input type="checkbox"/> 50m (170 ft) of relatively undisturbed vegetated areas, rocky areas, or open water for &gt; 50% circumference ..... <b>points = 3</b></p> <p><b>If buffer does not meet any of the criteria above:</b></p> <p><input type="checkbox"/> No paved areas (except paved trails) or buildings within 25m (80 ft) of wetland &gt; 95% circumference. Light to moderate grazing or lawns are OK ..... <b>points = 2</b></p> <p><input type="checkbox"/> No paved areas of buildings within 50m of wetland for &gt; 50% circumference. Light to moderate grazing or lawns are OK..... <b>points = 2</b></p> <p><input type="checkbox"/> Heavy grazing in buffer ..... <b>points = 1</b></p> <p><input type="checkbox"/> Vegetated buffers are &lt; 2m wide (6.6 ft) for more than 95% circumference (e.g. tilled fields, paving, basalt bedrock extend to edge of wetland) ..... <b>points = 0</b></p> <p><input checked="" type="checkbox"/> <b>Buffer does not meet any of the criteria above ..... points = 1</b></p> <p style="text-align: right;"><b>Arial photo showing buffers</b></p>	<p><b>Figure</b> _____</p> <p style="text-align: center;">1</p>
	<p>H 2.2 <b>Corridors and Connections</b> (see p. 81)</p> <p>H 2.2.1 Is the wetland part of a relatively undisturbed and unbroken vegetated corridor (either riparian or upland) that is at least 150 ft. wide, has at least a 30% cover of shrubs, forest or native undisturbed prairie, that connects to estuaries, other wetlands or undisturbed uplands that are at least 250 acres in size? (<i>Dams in riparian corridors, heavily used gravel roads, paved roads, are considered breaks in the corridor.</i>)</p> <p style="text-align: center;">YES = <b>4 points</b> (go to H 2.3)                      NO = go to H 2.2.2</p> <p>H. 2.2.2 Is the wetland part of a relatively undisturbed and unbroken vegetated corridor (either riparian or upland) that is at least 50 ft. wide, has at least 30% cover of shrubs or forest, and connects to estuaries, other wetlands or undisturbed uplands that are at least 25 acres in size? <b>OR a Lake-fringe wetland</b>, if it does not have an undisturbed corridor as in the question above?</p> <p style="text-align: center;">YES = <b>2 points</b> (go to H 2.3)                      NO = go to H 2.2.3</p> <p>H. 2.2.3 Is the wetland:</p> <ul style="list-style-type: none"> <li>• Within 5 mi (8km) of a brackish or salt water estuary OR</li> <li>• Within 3 miles of a large field or pasture (&gt; 40 acres) OR                      YES = 1 point</li> <li>• Within 1 mile of a lake greater than 20 acres?                                      NO = 0 points</li> </ul>	<p style="text-align: center;">2</p>

**Comments:**

**Exhibit 16**  
**SSDP2016-00415**  
**000967**

	<p>H 2.3 <u>Near or adjacent to other priority habitats listed by WDFW</u> (see p. 82): (see new and complete descriptions of WDFW priority habitats, and the counties in which they can be found, in the PHS report <a href="http://wdfw.wa.gov/hab/phslist.htm">http://wdfw.wa.gov/hab/phslist.htm</a> )</p> <p>Which of the following priority habitats are within 330 ft. (100m) of the wetland unit?  <i>NOTE: the connections do not have to be relatively undisturbed.</i></p> <p><input type="checkbox"/> <b>Aspen Stands:</b> Pure or mixed stands of aspen greater than 0.4 ha (1 acre).</p> <p><input type="checkbox"/> <b>Biodiversity Areas and Corridors:</b> Areas of habitat that are relatively important to various species of native fish and wildlife (full descriptions in WDFW PHS report p. 152).</p> <p><input type="checkbox"/> <b>Herbaceous Balds:</b> Variable size patches of grass and forbs on shallow soils over bedrock.</p> <p><input type="checkbox"/> <b>Old-growth/Mature forests:</b> (Old-growth west of Cascade crest) Stands of at least 2 tree species, forming a multi-layered canopy with occasional small openings; with at least 20 trees/ha (8 trees/acre) &gt; 81 cm (32 in) dbh or &gt; 200 years of age. (Mature forests) Stands with average diameters exceeding 53 cm (21 in) dbh; crown cover may be less than 100%; decay, decadence, numbers of snags, and quantity of large downed material is generally less than that found in old-growth; 80 - 200 years old west of the Cascade crest.</p> <p><input type="checkbox"/> <b>Oregon white Oak:</b> Woodlands Stands of pure oak or oak/conifer associations where canopy coverage of the oak component is important (full descriptions in WDFW PHS report p. 158).</p> <p><input checked="" type="checkbox"/> <b>Riparian:</b> The area adjacent to aquatic systems with flowing water that contains elements of both aquatic and terrestrial ecosystems which mutually influence each other.</p> <p><input type="checkbox"/> <b>Westside Prairies:</b> Herbaceous, non-forested plant communities that can either take the form of a dry prairie or a wet prairie (full descriptions in WDFW PHS report p. 161).</p> <p><input checked="" type="checkbox"/> <b>Instream:</b> The combination of physical, biological, and chemical processes and conditions that interact to provide functional life history requirements for instream fish and wildlife resources.</p> <p><input type="checkbox"/> <b>Nearshore:</b> Relatively undisturbed nearshore habitats. These include Coastal Nearshore, Open Coast Nearshore, and Puget Sound Nearshore. (full descriptions of habitats and the definition of relatively undisturbed are in WDFW report: pp. 167-169 and glossary in Appendix A).</p> <p><input type="checkbox"/> <b>Caves:</b> A naturally occurring cavity, recess, void, or system of interconnected passages under the earth in soils, rock, ice, or other geological formations and is large enough to contain a human.</p> <p><input type="checkbox"/> <b>Cliffs:</b> Greater than 7.6 m (25 ft) high and occurring below 5000 ft.</p> <p><input type="checkbox"/> <b>Talus:</b> Homogenous areas of rock rubble ranging in average size 0.15 - 2.0 m (0.5 - 6.5 ft), composed of basalt, andesite, and/or sedimentary rock, including riprap slides and mine tailings. May be associated with cliffs.</p> <p><input type="checkbox"/> <b>Snags and Logs:</b> Trees are considered snags if they are dead or dying and exhibit sufficient decay characteristics to enable cavity excavation/use by wildlife. Priority snags have a diameter at breast height of &gt; 51 cm (20 in) in western Washington and are &gt; 2 m (6.5 ft) in height. Priority logs are &gt; 30 cm (12 in) in diameter at the largest end, and &gt; 6 m (20 ft) long.</p> <p>If wetland has <b>3 or more</b> priority habitats = <b>4 points</b>  <b>If wetland has 2</b> priority habitats = <b>3 points</b>                  If wetland has <b>1</b> priority habitat = <b>1 point</b>                      No habitats = 0 points</p> <p>Note: All vegetated wetlands are by definition a priority habitat but are not included in this list. Nearby wetlands are addressed in question H 2.4)</p>	3
	<p>H 2.4 <u>Wetland Landscape:</u> Choose the <b>one</b> description of the landscape around the wetland that best fits (see p. 84)</p> <ul style="list-style-type: none"> <li>• There are at least 3 other wetlands within 1/2 mile, and the connections between them are relatively undisturbed (light grazing between wetlands OK, as is lake shore with some boating, but connections should NOT be bisected by paved roads, fill, fields, or other development.....points = 5</li> <li>• The wetland is Lake-fringe on a lake with little disturbance and there are 3 other lake-fringe wetlands within 1/2 mile .....points = 5</li> <li>• <b>There are at least 3 other wetlands within 1/2 mile, BUT the connections between them are disturbed.....points = 3</b></li> <li>• The wetland fringe on a lake <b>with</b> disturbance and there are 3 other lake-fringe wetlands within 1/2 mile .....points = 3</li> <li>• There is at least 1 wetland within 1/2 mile .....points = 2</li> <li>• There are no wetlands within 1/2 mile.....points = 0</li> </ul>	3
<b>H 2 TOTAL Score – opportunity for providing habitat</b> <i>Add the scores from H2.1, H2.2, H2.3, H2.4</i>		9
<i>TOTAL for H 1 from page 8</i>		7
<b>◆</b>	<b>Total Score for Habitat Functions</b> Add the points for H 1 and H 2; then <b>record the result on p. 1</b>	16

Comments:

### CATEGORIZATION BASED ON SPECIAL CHARACTERISTICS

*Please determine if the wetland meets the attributes described below  
and circle the appropriate answers and Category.*

<b>Wetland Type</b> – Check off any criteria that apply to the wetland. Circle the Category when the appropriate criteria are met.	
<b>SC1</b>	<p><b>Estuarine wetlands?</b> (see p.86)</p> <p>Does the wetland unit meet the following criteria for Estuarine wetlands?</p> <p><input type="checkbox"/> The dominant water regime is tidal,</p> <p><input type="checkbox"/> Vegetated, and</p> <p><input type="checkbox"/> With a salinity greater than 0.5 ppt.</p> <p style="text-align: center;">YES = Go to SC 1.1                      NO = <u>X</u></p>
	<p>SC 1.1 Is the wetland unit within a National Wildlife Refuge, National Park, National Estuary Reserve, Natural Area Preserve, State Park or Educational, Environmental, or Scientific Reserve designated under WAC 332-30-151?    YES = Category I                      NO = go to SC 1.2</p>
	<p>SC 1.2 Is the wetland at least 1 acre in size and meets at least two of the following conditions?</p> <p style="text-align: center;">YES = Category I                      NO = Category II</p> <p><input type="checkbox"/> The wetland is relatively undisturbed (has no diking, ditching, filling, cultivation, grazing, and has less than 10% cover of non-native plant species. If the non-native <i>Spartina</i> spp., are only species that cover more than 10% of the wetland, then the wetland should be given a dual rating (I/II). The area of <i>Spartina</i> would be rated a Category II while the relatively undisturbed upper marsh with native species would be a Category I. Do not, however, exclude the area of <i>Spartina</i> in determining the size threshold of 1 acre.</p> <p><input type="checkbox"/> At least 3/4 of the landward edge of the wetland has a 100 ft. buffer of shrub, forest, or un-grazed or un-mowed grassland</p> <p><input type="checkbox"/> The wetland has at least 2 of the following features: tidal channels, depressions with open water, or contiguous freshwater wetlands.</p>
	<p><b>Cat. I</b></p> <p><b>Cat. II</b></p> <p><b>Dual Rating I/II</b></p>
<b>SC2</b>	<p><b>Natural Heritage Wetlands</b> (see p. 87)</p> <p>Natural Heritage wetlands have been identified by the Washington Natural Heritage Program/DNR as either high quality undisturbed wetlands or wetlands that support state Threatened, Endangered, or Sensitive plant species.</p> <p>SC 2.1 Is the wetland being rated in a Section/Township/Range that contains a natural heritage wetland? (<i>This question is used to screen out most sites before you need to contact WNHP/DNR.</i>)</p> <p style="text-align: center;">S/T/R information from Appendix D _____ or accessed from WNHP/DNR web site _____</p> <p style="text-align: center;">YES _____ Contact WNHP/DNR (see p. 79) and go to SC 2.2                      NO = <u>X</u></p> <p>SC 2.2 Has DNR identified the wetland as a high quality undisturbed wetland or as a site with state threatened or endangered plant species?</p> <p style="text-align: center;">YES = Category 1                      NO _____ not a Heritage Wetland</p>
	<p><b>Cat I</b></p>
<b>SC3</b>	<p><b>Bogs</b> (see p. 87)</p> <p>Does the wetland (<b>or any part of the unit</b>) meet both the criteria for soils and vegetation in bogs? Use the key below to identify if the wetland is a bog. <i>If you answer yes you will still need to rate the wetland based on its function.</i></p> <ol style="list-style-type: none"> <li>1. Does the unit have organic soil horizons (i.e. layers of organic soil), either peats or mucks, that compose 16 inches or more of the first 32 inches of soil profile? (See Appendix B for a field key to identify organic soils)?    YES = go to question 3                      <b>NO = go to question 2</b></li> <li>2. Does the wetland have organic soils, either peats or mucks that are less than 16 inches deep over bedrock, or an impermeable hardpan such as clay or volcanic ash, or that are floating on a lake or pond?    YES = go to question 3                      <b>NO = is not a bog for purpose of rating</b></li> <li>3. Does the unit have more than 70% cover of mosses at ground level, AND other plants, if present, consist of the “bog” species listed in Table 3 as a significant component of the vegetation (more than 30% of the total shrub and herbaceous cover consists of species in Table 3)?</li> </ol> <p style="text-align: center;">YES = Is a bog for purpose of rating                      NO = go to question 4</p> <p>NOTE: If you are uncertain about the extent of mosses in the understory you may substitute that criterion by measuring the pH of the water that seeps into a hole dug at least 16” deep. If the pH is less than 5.0 and the “bog” plant species in Table 3 are present, the wetland is a bog.</p> <ol style="list-style-type: none"> <li>4. Is the unit forested (&gt; 30% cover) with sitka spruce, subalpine fir, western red cedar, western hemlock, lodgepole pine, quaking aspen, Englemann’s spruce, or western white pine. WITH any of the species (or combination of species) on the bog species plant list in Table 3 as a significant component of the ground cover (&gt; 30% coverage of the total shrub/herbaceous cover)?</li> </ol> <p style="text-align: center;">YES = Category I                      NO = Is not a bog for purpose of rating</p>
	<p><b>Cat. I</b></p>

**Exhibit 16**  
**SSDP2016-00415**  
**000969**

<p><b>SC4</b></p>	<p><b>Forested Wetlands</b> (see p. 90)                  Does the wetland have at least 1 acre of forest that meet one of these criteria for the Department of Fish and Wildlife's forests as priority habitats? <i>If you answer yes you will still need to rate the wetland based on its function.</i></p> <p>___ <b>Old-growth forests:</b> (west of Cascade Crest) Stands of at least two three species forming a multi-layered canopy with occasional small openings; with at least 8 trees/acre (20 trees/hectare) that are at least 200 years of age OR have a diameter at breast height (dbh) of 32 inches (81 cm or more).</p> <p>NOTE: The criterion for dbh is based on measurements for upland forests. Two-hundred year old trees in wetlands will often have a smaller dbh because their growth rates are often slower. The DFW criterion is and "OR" so old-growth forests do not necessarily have to have trees of this diameter.</p> <p>___ <b>Mature forests:</b> (west of the Cascade Crest) Stands where the largest trees are 80 – 200 years old OR have an average diameters (dbh) exceeding 21 inches (53 cm); crown cover may be less than 100%; decay, decadence, numbers of snags, and quantity of large downed material is generally less than that found in old-growth.</p> <p>YES = Category I                      NO = <u>X</u> not a forested wetland with special characteristics</p>	<p><b>Cat. I</b></p>
<p><b>SC5</b></p>	<p><b>Wetlands in Coastal Lagoons</b> (see p. 91)                  Does the wetland meet all of the following criteria of a wetland in a coastal lagoon?</p> <p>___ The wetland lies in a depression adjacent to marine waters that is wholly or partially separated from marine waters by sandbanks, gravel banks, shingle, or, less frequently, rocks.</p> <p>___ The lagoon in which the wetland is located contains surface water that is saline or brackish (&gt; 0.5 ppt) during most of the year in at least a portion of the lagoon (<i>needs to be measured near the bottom.</i>)</p> <p>YES = Go to SC 5.1                      NO <u>X</u> not a wetland in a coastal lagoon</p> <p>SC 5.1 Does the wetland meet all of the following three conditions?</p> <p>___ The wetland is relatively undisturbed (has no diking, ditching, filling, cultivation, grazing) and has less than 20% cover of invasive plant species (see list of invasive species on p. 74).</p> <p>___ At least 3/4 of the landward edge of the wetland has a 100 ft. buffer of shrub, forest, or un-grazed or un-mowed grassland.</p> <p>___ The wetland is larger than 1/10 acre (4350 square ft.)</p> <p>YES = Category I                      NO = Category II</p>	<p><b>Cat. I</b></p> <p><b>Cat. II</b></p>
<p><b>SC6</b></p>	<p><b>Interdunal Wetlands</b> (see p. 93)                  Is the wetland west of the 1889 line (also called the Western Boundary of Upland Ownership or WBUO)?</p> <p>YES = Go to SC 6.1                      NO <u>X</u> not an interdunal wetland for rating</p> <p><b><i>If you answer yes you will still need to rate the wetland based on its functions.</i></b></p> <p>In practical terms that means the following geographic areas:</p> <ul style="list-style-type: none"> <li>• Long Beach Peninsula -- lands west of SR 103</li> <li>• Grayland-Westport -- lands west of SR 105</li> <li>• Ocean Shores-Copalis – lands west of SR 115 and SR 109</li> </ul> <p>SC 6.1 Is the wetland one acre or larger, or is it in a mosaic of wetlands that is one acre or larger?</p> <p>YES = Category II                      NO = go to SC 6.2</p> <p>SC 6.2 Is the wetland between 0.1 and 1 acre, or is it in a mosaic of wetlands that is between 0.1 and 1 acre?</p> <p>YES = Category III</p>	<p><b>Cat. II</b></p> <p><b>Cat. III</b></p>
<p>◆</p>	<p><b>Category of wetland based on Special Characteristics</b>                  Choose the "highest" rating if wetland falls into several categories, and record on p. 1.                  If you answered NO for all types enter "Not Applicable" on p. 1</p>	<p><b>NA</b></p>

**Comments:**

Wetland name or number 15BC

**WETLAND RATING FORM – WESTERN WASHINGTON**  
Version 2 – Updated July 2006 to increase accuracy and reproducibility among users  
Updated Oct. 2008 with the new WDFW definitions for priority habitats

Name of wetland (if known): 15BC Date of site visit: 03-11-14

Rated by: Colin Worsley / Matt Maynard Trained by Ecology? Yes X No      Date of training: 11-2005 / 04-2006

SEC: 07 TOWNSHIP: 24N RANGE: 06E Is S/T/R in Appendix D? Yes      No X

Map of wetland unit: Figure      Estimated size ~0.15 acre

**SUMMARY OF RATING**

Category based on FUNCTIONS provided by wetland: I      II      III      IV X

Category I =	Score > 70
Category II =	Score 51 - 69
Category III =	Score 30 – 50
Category IV =	Score < 30

Score for Water Quality Functions	4
Score for Hydrologic Functions	10
Score for Habitat Functions	13
<b>TOTAL Score for Functions</b>	<b>27</b>

Category based on SPECIAL CHARACTERISTICS of Wetland I      II      Does not apply X

**Final Category** (choose the “highest” category from above”) IV

**Summary of basic information about the wetland unit.**

Wetland Unit has Special Characteristics		Wetland HGM Class used for Rating	
<b>Estuarine</b>		<b>Depressional</b>	<b>X</b>
<b>Natural Heritage Wetland</b>		<b>Riverine</b>	(x)
<b>Bog</b>		<b>Lake-fringe</b>	
<b>Mature Forest</b>		<b>Slope</b>	(x)
<b>Old Growth Forest</b>		<b>Flats</b>	
<b>Coastal Lagoon</b>		<b>Freshwater Tidal</b>	
<b>Interdunal</b>			
None of the above	X	Check if unit has multiple HGM classes present	<b>X</b>

**Does the wetland being rated meet any of the criteria below?** If you answer YES to any of the questions below you will need to protect the wetland according to the regulations regarding the special characteristics found in the wetland.

Check List for Wetlands that Need Additional Protection (in addition to the protection recommended for its category)	YES	NO
SP1. <i>Has the wetland unit been documented as a habitat for any Federally listed Threatened or Endangered <b>animal or plant</b> species (T/E species)?</i> For the purposes of this rating system, “documented” means the wetland is on the appropriate state or federal database.		X
SP2. <i>Has the wetland unit been documented as habitat for any State listed Threatened or Endangered <b>animal</b> species?</i> For the purposes of this rating system, “documented” means the wetland is on the appropriate state database. Note: Wetlands with State listed plant species are categorized as Category 1 Natural Heritage Wetlands (see p. 19 of data form).		X
SP3. <i>Does the wetland unit contain individuals of Priority species listed by the WDFW for the state?</i>		X
SP4. <i>Does the wetland unit have a local significance in addition to its functions?</i> For example, the wetland has been identified in the Shoreline Master Program, the Critical Areas Ordinance, or in a local management plan as having special significance.		X

To complete the next part of the data sheet you will need to determine the Hydrogeomorphic Class of the wetland being rated.

Exhibit 16  
SSDP2016-00415  
000097



### Classification of Vegetated Wetlands for Western Washington

If the hydrologic criteria listed in each question do not apply to the entire unit being rated, you probably have a unit with multiple HGM classes. In this case, identify which hydrologic criteria in questions 1-7 apply, and go to Question 8.

1. Are the water levels in the entire unit usually controlled by tides (i.e. except during floods)?

**NO – go to 2**

**YES – the wetland class is Tidal Fringe**

If yes, is the salinity of the water during periods of annual low flow below 0.5 ppt (parts per thousand)?

**YES – Freshwater Tidal Fringe**

**NO – Saltwater Tidal Fringe (Estuarine)**

*If your wetland can be classified as a Freshwater Tidal Fringe use the forms for **Riverine** wetlands. If it is a Saltwater Tidal Fringe it is rated as an **Estuarine** wetland. Wetlands that were call estuarine in the first and second editions of the rating system are called Salt Water Tidal Fringe in the Hydrogeomorphic Classification. Estuarine wetlands were categorized separately in the earlier editions, and this separation is being kept in this revision. To maintain consistency between editions, the term “Estuarine” wetland is kept. Please note, however, that the characteristics that define Category I and II estuarine wetlands have changed (see p. \_\_\_\_\_).*

2. The entire wetland unit is flat and precipitation is only source (>90%) of water to it. Groundwater and surface water runoff are NOT sources of water to the unit.

**NO – go to 3**

**YES – The wetland class is Flats**

If your wetland can be classified as a “Flats” wetland, use the form for **Depressional** wetlands.

3. Does the entire wetland meet both of the following criteria?

\_\_\_\_\_ The vegetated part of the wetland is on the shores of a body of permanent open water (without any vegetation on the surface) where at least 20 acres (8ha) in size;

\_\_\_\_\_ At least 30% of the open water area is deeper than 6.6 (2 m)?

**NO – go to 4**

**YES – The wetland class is Lake-fringe (Lacustrine Fringe)**

4. Does the entire wetland meet all of the following criteria?

\_\_\_\_\_ The wetland is on a slope (*slope can be very gradual*).

\_\_\_\_\_ The water flows through the wetland in one direction (unidirectional) and usually comes from seeps. It may flow subsurface, as sheetflow, or in a swale without distinct banks.

\_\_\_\_\_ The water leaves the wetland **without being impounded**?

*NOTE: Surface water does not pond in these types of wetlands except occasionally in very small and shallow depressions or behind hummocks (depressions are usually <3 ft diameter and less than 1 foot deep).*

**NO – go to 5**

**YES – The wetland class is Slope**

5. Does the entire wetland meet all of the following criteria?

\_\_\_\_\_ The unit is in a valley or stream channel where it gets inundated by overbank flooding from that stream or river.

\_\_\_\_\_ The overbank flooding occurs at least once every two years.

*NOTE: The riverine unit can contain depressions that are filled with water when the river is not flooding..*

**NO – go to 6**

**YES – The wetland class is Riverine**

6. Is the entire wetland unit in a topographic depression in which water ponds, or is saturated to the surface, at some time of the year. This means that any outlet, if present is higher than the interior of the wetland.

**NO – go to 7**

**YES – The wetland class is Depressional**

7. Is the entire wetland located in a very flat area with no obvious depression and no overbank flooding. The unit does not pond surface water more than a few inches. The unit seems to be maintained by high groundwater in the area. The wetland may be ditched, but has no obvious natural outlet.

**No – go to 8**

**YES – The wetland class is Depressional**

8. Your wetland unit seems to be difficult to classify and probably contains several different HGM classes. For example, seeps at the base of a slope may grade into a riverine floodplain, or a small stream within a depressional wetland has a zone of flooding along its sides. **GO BACK AND IDENTIFY WHICH OF THE HYDROLOGIC REGIMES DESCRIBED IN QUESTIONS 1-7 APPLY TO DIFFERENT AREAS IN THE UNIT** (make a rough sketch to help you decide). Use the following table to identify the appropriate class to use for the rating system if you have several HGM classes present within your wetland. **NOTE:** Use this table only if the class that is recommended in the second column represents 10% or more of the total area of the wetland unit being rated. If the area of the class listed in column 2 is less than 10% of the unit, classify the wetland using the class that represents more than 90% of the total area.

<i>HGM Classes within the wetland unit being rated</i>	<i>HGM Class to Use in Rating</i>
Slope + Riverine	Riverine
Slope + Depressional	Depressional
Slope + Lake-fringe	Lake-fringe
Depressional + Riverine along stream within boundary	Depressional
Depressional + Lake-fringe	Depressional
Salt Water Tidal Fringe and any other class of freshwater wetland	Treat as ESTUARINE under wetlands with special characteristics

Exhibit 16

SSDP2016-00415

000972

If you are unable still to determine which of the above criteria apply to your wetland, or you have more than 2 HGM classes within a wetland boundary, classify the wetland as **Depressional** for the rating.

<b>D Depressional and Flat Wetlands</b>		<b>Points</b>
WATER QUALITY FUNCTIONS – Indicators that wetland functions to improve water quality.		(only 1 score per box) (see p.38)
<b>D 1</b>	<b>Does the wetland have the <u>potential</u> to improve water quality?</b>	
D 1.1	Characteristics of surface water flows out of the wetland: • Unit is a depression with no surface water leaving it (no outlet)..... points = 3 • Unit has an intermittently flowing, OR highly constricted, permanently flowing outlet ..... points = 2 • <b>Unit has an unconstricted, or slightly constricted, surface outlet (permanently flowing) ..... points = 1</b> • Unit is a “flat” depression (Q.7 on key), or in the Flats class, with permanent surface outflow <b>and no obvious natural outlet</b> and/or outlet is a man-made ditch..... points = 1 (If ditch is not permanently flowing treat unit as “intermittently flowing”) <b>Provide photo or drawing</b>	<b>Figure</b> ____  1
D 1.2	The soil 2 inches below the surface (or duff layer) is clay or organic (use NRCS definitions) YES points = 4 NO points = 0	0
D 1.3	Characteristics of persistent vegetation (emergent, shrub, and/or forest Cowardin class): • Wetland has persistent, ungrazed vegetation > = 95% of area..... points = 5 • Wetland has persistent, ungrazed vegetation > = 1/2 of area..... points = 3 • <b>Wetland has persistent, ungrazed vegetation &gt; = 1/10 of area..... points = 1</b> • Wetland has persistent, ungrazed vegetation < 1/10 of area..... points = 0 <b>Map of Cowardin vegetation classes</b>	<b>Figure</b> ____  1
D 1.4	Characteristics of seasonal ponding or inundation: <i>This is the area of the wetland that is ponded for at least 2 months, but dries out sometime during the year. Do not count the area that is permanently ponded. Estimate area as the average condition 5 out of 10 years.</i> • Area seasonally ponded is > 1/2 total area of wetland ..... points = 4 • Area seasonally ponded is > 1/4 total area of wetland ..... points = 2 • <b>Area seasonally ponded is &lt; 1/4 total area of wetland ..... points = 0</b> <b>Map of Hydroperiods</b>	<b>Figure</b> ____  0
<b>Total for D 1</b>		Add the points in the boxes above <b>2</b>
<b>D 2</b>	<b>Does the wetland have the <u>opportunity</u> to improve water quality?</b>	(see p. 44)
Answer YES if you know or believe there are pollutants in groundwater or surface water coming into the wetland that would otherwise reduce water quality in streams, lakes or groundwater downgradient from the wetland? <i>Note which of the following conditions provide the sources of pollutants. A unit may have pollutants coming from several sources, but any single source would qualify as opportunity.</i> ____ Grazing in the wetland or within 150 ft ____ Untreated stormwater discharges to wetland ____ Tilled fields or orchards within 150 ft. of wetland ____ A stream or culvert discharges into wetland that drains developed areas, residential areas, farmed fields, roads, or clear-cut logging <input checked="" type="checkbox"/> Residential, urban areas, golf courses are within 150 ft. of wetland ____ Wetland is fed by groundwater high in phosphorus or nitrogen ____ Other _____ YES multiplier is 2 NO multiplier is 1		Multiplier  X2
<b>◆ TOTAL – Water Quality Functions</b>		4
Multiply the score from D1 by D2; then <b>add score to table on p. 1</b> HYDROLOGIC FUNCTIONS – Indicators that wetland unit functions to reduce flooding and stream degradation.		
<b>D 3</b>	<b>Does the wetland have the <u>potential</u> to reduce flooding and erosion?</b>	(see p.46)
D 3.1	Characteristics of surface water flows out of the wetland unit • Unit is a depression with no surface water leaving it (no outlet)..... points = 4 • <b>Unit has an intermittently flowing, OR highly constricted permanently flowing outlet ..... points = 2</b> • Unit is a “flat” depression (Q.7 on key) or in the Flats class, with permanent surface outflow <b>and no obvious natural outlet</b> and/or outlet is a man-made ditch..... points = 1 (If ditch is not permanently flowing treat unit as “intermittently flowing”) • Unit has an unconstricted, or slightly constricted, surface outlet (permanently flowing) ..... points = 0	2
D 3.2	Depth of storage during wet periods. <i>Estimate the height of ponding above the bottom of the outlet. For units with no outlet measure from the surface of permanent water or deepest part (if dry).</i> • Marks of ponding are 3 ft. or more above the surface or bottom of the outlet ..... points = 7 • The wetland is a “headwater” wetland..... points = 5 • Marks of ponding between 2 ft. to < 3 ft. from surface or bottom of outlet ..... points = 5 • Marks are at least 0.5 ft. to < 2 ft. from surface or bottom of outlet ..... points = 3 • Wetland is flat (yes to Q.2 or Q.7)but has small depressions on the surface that trap water points = 1 • <b>Marks of ponding less than 0.5 ft ..... points = 0</b>	0
D 3.3	Contribution of wetland unit to storage in the watershed: <i>Estimate the ratio of the area of upstream basin contributing surface water to the wetland to the area of the wetland unit itself.</i> • The area of the basin is less than 10 times the area of unit..... points = 5 • <b>The area of the basin is 10 to 100 times the area of the unit ..... points = 3</b> • The area of the basin is more than 100 times the area of the unit ..... points = 0 • Entire unit is in the FLATS class ..... points = 5	3
<b>Total for D 3</b>		Add the points in the boxes above <b>5</b>

<b>D 4</b>	<p><b>Does the wetland have the <u>opportunity</u> to reduce flooding and erosion?</b></p> <p>Answer YES if the unit is in a location in the watershed where the flood storage, or reduction in water velocity, it provides helps protect downstream property and aquatic resources from flooding or excessive and/or erosive flows. Answer NO if the water coming into the wetland is controlled by a structure such as flood gate, tide gate, flap valve, reservoir etc. OR you estimate that more than 90% of the water in the wetland is from groundwater in areas where damaging groundwater flooding does not occur. <i>Note which of the following indicators of opportunity apply.</i></p> <p><input type="checkbox"/> Wetland is in a headwater of a river or stream that has flooding problems.</p> <p><input checked="" type="checkbox"/> Wetland drains to a river or stream that has flooding problems</p> <p><input type="checkbox"/> Wetland has no outlet and impounds surface runoff water that might otherwise flow into a river or stream that has flooding problems</p> <p><input type="checkbox"/> Other _____</p> <p><b>YES multiplier is 2</b>                      NO multiplier is 1</p>	<p>(see p. 49)</p> <p>Multiplier</p> <p><u>X2</u></p>
◆	<p><b>TOTAL – Hydrologic Functions</b>                      Multiply the score from D3 by D4; then <i>add score to table on p. 1</i></p>	<p>10</p>

Comments:



<p><i>These questions apply to wetlands of all HGM classes.</i></p> <p>HABITAT FUNCTIONS – Indicators that wetland functions to provide important habitat.</p>		<p><b>Points</b> (only 1 score per box)</p>
<b>H 1</b>	<b>Does the wetland have the potential to provide habitat for many species?</b>	
H 1.1	<p><u>Vegetation structure</u> (see P. 72): Check the types of vegetation classes present (as defined by Cowardin) – Size threshold for each class is 1/4 acre or more than 10% of the area if unit is smaller than 2.5 acres.</p> <p><input type="checkbox"/> Aquatic Bed <input checked="" type="checkbox"/> Emergent plants <input type="checkbox"/> Scrub/shrub (areas where shrubs have &gt; 30% cover) <input checked="" type="checkbox"/> Forested (areas where trees have &gt; 30% cover) If the unit has a forested class check if: <input checked="" type="checkbox"/> The forested class has 3 out of 5 strata (canopy, sub-canopy, shrubs, herbaceous, moss/ground-cover) that each cover 20% within the forested polygon. Add the number of vegetation types that qualify. If you have:</p> <p>4 structures or more..... points = 4 2 structures..... points = 1</p> <p style="text-align: right;"><b>Map of Cowardin vegetation classes</b> 3 structures..... points = 2 1 structure ..... points = 0</p>	<p><b>Figure</b> ____</p> <p style="text-align: right;">2</p>
H 1.2	<p><u>Hydroperiods</u> (see p.73): Check the types of water regimes (hydroperiods) present within the wetland. The water regime has to cover more than 10% of the wetland or 1/4 acre to count (see text for descriptions of hydroperiods).</p> <p><input type="checkbox"/> Permanently flooded or inundated <input type="checkbox"/> Seasonally flooded or inundated <input type="checkbox"/> Occasionally flooded or inundated <input checked="" type="checkbox"/> Saturated only <input checked="" type="checkbox"/> Permanently flowing stream or river in, or adjacent to, the wetland <input type="checkbox"/> Seasonally flowing stream in, or adjacent to, the wetland <input type="checkbox"/> <b>Lake-fringe wetland..... = 2 points</b> <input type="checkbox"/> <b>Freshwater tidal wetland..... = 2 points</b></p> <p style="text-align: right;"><b>Map of hydroperiods</b></p> <p>4 or more types present points = 3 3 or more types present..... points = 2 2 types present..... points = 1 1 type present ..... points = 0</p>	<p><b>Figure</b> ____</p> <p style="text-align: right;">1</p>
H 1.3	<p><u>Richness of Plant Species</u> (see p. 75): Count the number of plant species in the wetland that cover at least 10 ft<sup>2</sup> (different patches of the same species can be combined to meet the size threshold) You do not have to name the species. Do not include Eurasian Milfoil, reed canarygrass, purple loosestrife, Canadian Thistle. If you counted: &gt; 19 species ..... points = 2 5 – 19 species..... points = 1 &lt; 5 species ..... points = 0</p> <p>List species below if you want to:</p> <p>_____</p> <p>_____</p> <p>_____</p>	<p style="text-align: right;">1</p>
H 1.4	<p><u>Interspersion of Habitats</u> (see p. 76): Decided from the diagrams below whether interspersion between Cowardin vegetation (described in H1.1), or the classes and unvegetated areas (can include open water or mudflats) is high, medium, low, or none.</p> <div style="display: flex; justify-content: space-around;"> <div style="text-align: center;">  <p>None = 0 points</p> </div> <div style="text-align: center;">  <p>Low = 1 point</p> </div> <div style="text-align: center;">  <p>Moderate = 2 points</p> </div> <div style="text-align: center;">  </div> </div> <div style="display: flex; justify-content: space-around; margin-top: 20px;"> <div style="text-align: center;">  </div> <div style="text-align: center;">  <p>High = 3 points</p> </div> <div style="text-align: center;">  <p>[riparian braided channels]</p> </div> </div> <p style="text-align: right;">Note: If you have 4 or more classes or 3 vegetation classes and open water, the rating is always “high”.  Use map of Cowardin classes.</p>	<p><b>Figure</b> ____</p> <p style="text-align: right;">1</p>
H 1.5	<p><u>Special Habitat Features</u> (see p. 77): Check the habitat features that are present in the wetland. The number of checks is the number of points you put into the next column.</p> <p><input type="checkbox"/> Large, downed, woody debris within the wetland (&gt; 4 in. diameter and 6 ft. long) <input type="checkbox"/> Standing snags (diameter at the bottom &gt; 4 inches) in the wetland <input type="checkbox"/> Undercut banks are present for at least 6.6 ft. (2m) and/or overhanging vegetation extends at least 3.3 ft. (1m) over a stream (or ditch) in, or contiguous with the unit, for at least 33 ft. (10m) <input type="checkbox"/> Stable steep banks of fine material that might be used by beaver or muskrat for denning (&gt; 30 degree slope) OR signs of recent beaver activity are present (cut shrubs or trees that have not yet turned grey/brown) <input type="checkbox"/> At least 1/4 acre of thin-stemmed persistent vegetation or woody branches are present in areas that are permanently or seasonally inundated (structures for egg-laying by amphibians) <input type="checkbox"/> Invasive plants cover less than 25% of the wetland area in each stratum of plants</p> <p><i>NOTE: The 20% stated in early printings of the manual on page 78 is an error.</i></p>	<p style="text-align: right;">0</p>
<b>H 1 TOTAL Score – potential for providing habitat</b>		<p>Add the points in the column.</p> <p style="text-align: right;"><b>5</b></p>

Exhibit 16  
SSDP2016-00415  
008973

H 2	Does the wetland have the <u>opportunity</u> to provide habitat for many species?	(only 1 score per box)
	<p>H 2.1 <u>Buffers</u> (see P. 80): Choose the description that best represents condition of buffer of wetland unit. The highest scoring criterion that applies to the wetland is to be used in the rating. See text for definition of "undisturbed".</p> <p><input type="checkbox"/> 100m (330 ft) of relatively undisturbed vegetated areas, rocky areas, or open water &gt; 95% of circumference. No structures are within the undisturbed part of buffer (relatively undisturbed also means no grazing, no landscaping, no daily human use)..... <b>points = 5</b></p> <p><input type="checkbox"/> 100m (330 ft) of relatively undisturbed vegetated areas, rocky areas, or open water &gt; 50% circumference ..... <b>points = 4</b></p> <p><input type="checkbox"/> 50m (170 ft) of relatively undisturbed vegetated areas, rocky areas, or open water &gt; 95% circumference ..... <b>points = 4</b></p> <p><input type="checkbox"/> 100m (330 ft) of relatively undisturbed vegetated areas, rocky areas, or open water &gt; 25% circumference ..... <b>points = 3</b></p> <p><input type="checkbox"/> 50m (170 ft) of relatively undisturbed vegetated areas, rocky areas, or open water for &gt; 50% circumference ..... <b>points = 3</b></p> <p><b>If buffer does not meet any of the criteria above:</b></p> <p><input type="checkbox"/> No paved areas (except paved trails) or buildings within 25m (80 ft) of wetland &gt; 95% circumference. Light to moderate grazing or lawns are OK ..... <b>points = 2</b></p> <p><input type="checkbox"/> No paved areas of buildings within 50m of wetland for &gt; 50% circumference. Light to moderate grazing or lawns are OK..... <b>points = 2</b></p> <p><input type="checkbox"/> Heavy grazing in buffer ..... <b>points = 1</b></p> <p><input type="checkbox"/> Vegetated buffers are &lt; 2m wide (6.6 ft) for more than 95% circumference (e.g. tilled fields, paving, basalt bedrock extend to edge of wetland) ..... <b>points = 0</b></p> <p><input checked="" type="checkbox"/> Buffer does not meet any of the criteria above ..... <b>points = 1</b></p> <p style="text-align: right;"><b>Arial photo showing buffers</b></p>	<p>Figure ____</p> <p style="text-align: center;">1</p>
	<p>H 2.2 <u>Corridors and Connections</u> (see p. 81)</p> <p>H 2.2.1 Is the wetland part of a relatively undisturbed and unbroken vegetated corridor (either riparian or upland) that is at least 150 ft. wide, has at least a 30% cover of shrubs, forest or native undisturbed prairie, that connects to estuaries, other wetlands or undisturbed uplands that are at least 250 acres in size? (<i>Dams in riparian corridors, heavily used gravel roads, paved roads, are considered breaks in the corridor.</i>)</p> <p style="padding-left: 40px;">YES = <b>4 points</b> (go to H 2.3) <span style="margin-left: 100px;"><b>NO = go to H 2.2.2</b></span></p> <p>H. 2.2.2 Is the wetland part of a relatively undisturbed and unbroken vegetated corridor (either riparian or upland) that is at least 50 ft. wide, has at least 30% cover of shrubs or forest, and connects to estuaries, other wetlands or undisturbed uplands that are at least 25 acres in size? <b>OR a Lake-fringe</b> wetland, if it does not have an undisturbed corridor as in the question above?</p> <p style="padding-left: 40px;">YES = <b>2 points</b> (go to H 2.3) <span style="margin-left: 100px;"><b>NO = go to H 2.2.3</b></span></p> <p>H. 2.2.3 Is the wetland:</p> <ul style="list-style-type: none"> <li>• Within 5 mi (8km) of a brackish or salt water estuary OR</li> <li>• Within 3 miles of a large field or pasture (&gt; 40 acres) OR <span style="float: right;"><b>YES = 1 point</b></span></li> <li>• <b>Within 1 mile of a lake greater than 20 acres?</b> <span style="float: right;"><b>NO = 0 points</b></span></li> </ul>	<p style="text-align: center;">1</p>

Comments:

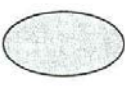
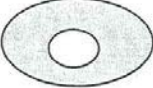
	<p>H 2.3 <u>Near or adjacent to other priority habitats listed by WDFW</u> (see p. 82): (see new and complete descriptions of WDFW priority habitats, and the counties in which they can be found, in the PHS report <a href="http://wdfw.wa.gov/hab/phslist.htm">http://wdfw.wa.gov/hab/phslist.htm</a>)</p> <p>Which of the following priority habitats are within 330 ft. (100m) of the wetland unit?  <i>NOTE: the connections do not have to be relatively undisturbed.</i></p> <p><input type="checkbox"/> <b>Aspen Stands:</b> Pure or mixed stands of aspen greater than 0.4 ha (1 acre).</p> <p><input type="checkbox"/> <b>Biodiversity Areas and Corridors:</b> Areas of habitat that are relatively important to various species of native fish and wildlife (full descriptions in WDFW PHS report p. 152).</p> <p><input type="checkbox"/> <b>Herbaceous Balds:</b> Variable size patches of grass and forbs on shallow soils over bedrock.</p> <p><input type="checkbox"/> <b>Old-growth/Mature forests:</b> (Old-growth west of Cascade crest) Stands of at least 2 tree species, forming a multi-layered canopy with occasional small openings; with at least 20 trees/ha (8 trees/acre) &gt; 81 cm (32 in) dbh or &gt; 200 years of age. (Mature forests) Stands with average diameters exceeding 53 cm (21 in) dbh; crown cover may be less than 100%; decay, decadence, numbers of snags, and quantity of large downed material is generally less than that found in old-growth; 80 - 200 years old west of the Cascade crest.</p> <p><input type="checkbox"/> <b>Oregon white Oak:</b> Woodlands Stands of pure oak or oak/conifer associations where canopy coverage of the oak component is important (full descriptions in WDFW PHS report p. 158).</p> <p><input checked="" type="checkbox"/> <b>Riparian:</b> The area adjacent to aquatic systems with flowing water that contains elements of both aquatic and terrestrial ecosystems which mutually influence each other.</p> <p><input type="checkbox"/> <b>Westside Prairies:</b> Herbaceous, non-forested plant communities that can either take the form of a dry prairie or a wet prairie (full descriptions in WDFW PHS report p. 161).</p> <p><input checked="" type="checkbox"/> <b>Instream:</b> The combination of physical, biological, and chemical processes and conditions that interact to provide functional life history requirements for instream fish and wildlife resources.</p> <p><input type="checkbox"/> <b>Nearshore:</b> Relatively undisturbed nearshore habitats. These include Coastal Nearshore, Open Coast Nearshore, and Puget Sound Nearshore. (full descriptions of habitats and the definition of relatively undisturbed are in WDFW report: pp. 167-169 and glossary in Appendix A).</p> <p><input type="checkbox"/> <b>Caves:</b> A naturally occurring cavity, recess, void, or system of interconnected passages under the earth in soils, rock, ice, or other geological formations and is large enough to contain a human.</p> <p><input type="checkbox"/> <b>Cliffs:</b> Greater than 7.6 m (25 ft) high and occurring below 5000 ft.</p> <p><input type="checkbox"/> <b>Talus:</b> Homogenous areas of rock rubble ranging in average size 0.15 - 2.0 m (0.5 - 6.5 ft), composed of basalt, andesite, and/or sedimentary rock, including riprap slides and mine tailings. May be associated with cliffs.</p> <p><input type="checkbox"/> <b>Snags and Logs:</b> Trees are considered snags if they are dead or dying and exhibit sufficient decay characteristics to enable cavity excavation/use by wildlife. Priority snags have a diameter at breast height of &gt; 51 cm (20 in) in western Washington and are &gt; 2 m (6.5 ft) in height. Priority logs are &gt; 30 cm (12 in) in diameter at the largest end, and &gt; 6 m (20 ft) long.</p> <p>If wetland has <b>3 or more</b> priority habitats = <b>4 points</b>  <b>If wetland has 2</b> priority habitats = <b>3 points</b>                  If wetland has <b>1</b> priority habitat = <b>1 point</b>                      No habitats = 0 points</p> <p>Note: All vegetated wetlands are by definition a priority habitat but are not included in this list. Nearby wetlands are addressed in question H 2.4)</p>	3
	<p>H 2.4 <u>Wetland Landscape:</u> Choose the <b>one</b> description of the landscape around the wetland that best fits (see p. 84)</p> <ul style="list-style-type: none"> <li>• There are at least 3 other wetlands within 1/2 mile, and the connections between them are relatively undisturbed (light grazing between wetlands OK, as is lake shore with some boating, but connections should NOT be bisected by paved roads, fill, fields, or other development.....points = 5</li> <li>• The wetland is Lake-fringe on a lake with little disturbance and there are 3 other lake-fringe wetlands within 1/2 mile .....points = 5</li> <li>• <b>There are at least 3 other wetlands within 1/2 mile, BUT the connections between them are disturbed.....points = 3</b></li> <li>• The wetland fringe on a lake <b>with</b> disturbance and there are 3 other lake-fringe wetlands within 1/2 mile .....points = 3</li> <li>• There is at least 1 wetland within 1/2 mile .....points = 2</li> <li>• There are no wetlands within 1/2 mile.....points = 0</li> </ul>	3
<b>H 2 TOTAL Score – opportunity for providing habitat</b> <i>Add the scores from H2.1, H2.2, H2.3, H2.4</i>		8
<i>TOTAL for H 1 from page 8</i>		5
◆	<b>Total Score for Habitat Functions</b> Add the points for H 1 and H 2; then <b>record the result on p. 1</b>	13

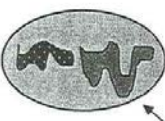
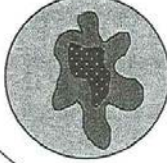
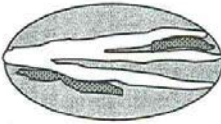
Comments:

**CATEGORIZATION BASED ON SPECIAL CHARACTERISTICS**

***Please determine if the wetland meets the attributes described below and circle the appropriate answers and Category.***

<b>Wetland Type</b> – Check off any criteria that apply to the wetland. Circle the Category when the appropriate criteria are met.	
<b>SC1</b>	<p><b><u>Estuarine wetlands?</u></b> (see p.86)</p> <p>Does the wetland unit meet the following criteria for Estuarine wetlands?</p> <p><input type="checkbox"/> The dominant water regime is tidal,  <input type="checkbox"/> Vegetated, and  <input type="checkbox"/> With a salinity greater than 0.5 ppt.</p> <p>YES = Go to SC 1.1                                  NO <u>  X  </u></p>
	<p>SC 1.1 Is the wetland unit within a National Wildlife Refuge, National Park, National Estuary Reserve, Natural Area Preserve, State Park or Educational, Environmental, or Scientific Reserve designated under WAC 332-30-151?      YES = Category I                                  NO = go to SC 1.2</p>
	<p>SC 1.2 Is the wetland at least 1 acre in size and meets at least two of the following conditions?</p> <p>YES = Category I                                  NO = Category II</p> <p><input type="checkbox"/> The wetland is relatively undisturbed (has no diking, ditching, filling, cultivation, grazing, and has less than 10% cover of non-native plant species. If the non-native <i>Spartina</i> spp., are only species that cover more than 10% of the wetland, then the wetland should be given a dual rating (I/II). The area of <i>Spartina</i> would be rated a Category II while the relatively undisturbed upper marsh with native species would be a Category I. Do not, however, exclude the area of <i>Spartina</i> in determining the size threshold of 1 acre.  <input type="checkbox"/> At least 3/4 of the landward edge of the wetland has a 100 ft. buffer of shrub, forest, or un-grazed or un-mowed grassland  <input type="checkbox"/> The wetland has at least 2 of the following features: tidal channels, depressions with open water, or contiguous freshwater wetlands.</p>
	<p><b>Cat. I</b></p> <p><b>Cat. II</b></p> <p><b>Dual Rating I/II</b></p>
<b>SC2</b>	<p><b><u>Natural Heritage Wetlands</u></b> (see p. 87)</p> <p>Natural Heritage wetlands have been identified by the Washington Natural Heritage Program/DNR as either high quality undisturbed wetlands or wetlands that support state Threatened, Endangered, or Sensitive plant species.</p> <p>SC 2.1 Is the wetland being rated in a Section/Township/Range that contains a natural heritage wetland? (<i>This question is used to screen out most sites before you need to contact WNHP/DNR.</i>)  S/T/R information from Appendix D _____ or accessed from WNHP/DNR web site _____  YES _____ Contact WNHP/DNR (see p. 79) and go to SC 2.2                                  NO <u>  X  </u></p> <p>SC 2.2 Has DNR identified the wetland as a high quality undisturbed wetland or as a site with state threatened or endangered plant species?  YES = Category 1                                  NO _____ not a Heritage Wetland</p>
	<p><b>Cat I</b></p>
<b>SC3</b>	<p><b><u>Bogs</u></b> (see p. 87)</p> <p>Does the wetland (<b>or any part of the unit</b>) meet both the criteria for soils and vegetation in bogs? Use the key below to identify if the wetland is a bog. <b><i>If you answer yes you will still need to rate the wetland based on its function.</i></b></p> <p>1. Does the unit have organic soil horizons (i.e. layers of organic soil), either peats or mucks, that compose 16 inches or more of the first 32 inches of soil profile? (See Appendix B for a field key to identify organic soils)?      YES = go to question 3      <b>NO = go to question 2</b></p> <p>2. Does the wetland have organic soils, either peats or mucks that are less than 16 inches deep over bedrock, or an impermeable hardpan such as clay or volcanic ash, or that are floating on a lake or pond?      YES = go to question 3      <b>NO = is not a bog for purpose of rating</b></p> <p>3. Does the unit have more than 70% cover of mosses at ground level, AND other plants, if present, consist of the “bog” species listed in Table 3 as a significant component of the vegetation (more than 30% of the total shrub and herbaceous cover consists of species in Table 3)?  YES = Is a bog for purpose of rating                                  NO = go to question 4</p> <p>NOTE: If you are uncertain about the extent of mosses in the understory you may substitute that criterion by measuring the pH of the water that seeps into a hole dug at least 16” deep. If the pH is less than 5.0 and the “bog” plant species in Table 3 are present, the wetland is a bog.</p> <p>4. Is the unit forested (&gt; 30% cover) with sitka spruce, subalpine fir, western red cedar, western hemlock, lodgepole pine, quaking aspen, Englemann’s spruce, or western white pine. WITH any of the species (or combination of species) on the bog species plant list in Table 3 as a significant component of the ground cover (&gt; 30% coverage of the total shrub/herbaceous cover)?  YES = Category I                                  NO = Is not a bog for purpose of rating</p>
	<p><b>Cat. I</b></p>

**Exhibit 16**  
**SSDP2016-00415**  
**000978**

<p><b>SC4</b></p>	<p><b>Forested Wetlands</b> (see p. 90)                  Does the wetland have at least 1 acre of forest that meet one of these criteria for the Department of Fish and Wildlife's forests as priority habitats? <i>If you answer yes you will still need to rate the wetland based on its function.</i>                  ___ <b>Old-growth forests:</b> (west of Cascade Crest) Stands of at least two three species forming a multi-layered canopy with occasional small openings; with at least 8 trees/acre (20 trees/hectare) that are at least 200 years of age OR have a diameter at breast height (dbh) of 32 inches (81 cm or more).                  NOTE: The criterion for dbh is based on measurements for upland forests. Two-hundred year old trees in wetlands will often have a smaller dbh because their growth rates are often slower. The DFW criterion is and "OR" so old-growth forests do not necessarily have to have trees of this diameter.                  ___ <b>Mature forests:</b> (west of the Cascade Crest) Stands where the largest trees are 80 – 200 years old OR have an average diameters (dbh) exceeding 21 inches (53 cm); crown cover may be less than 100%; decay, decadence, numbers of snags, and quantity of large downed material is generally less than that found in old-growth.                  YES = Category I                      NO = <u>X</u> not a forested wetland with special characteristics</p>	<p><b>Cat. I</b></p>
<p><b>SC5</b></p>	<p><b>Wetlands in Coastal Lagoons</b> (see p. 91)                  Does the wetland meet all of the following criteria of a wetland in a coastal lagoon?                  ___ The wetland lies in a depression adjacent to marine waters that is wholly or partially separated from marine waters by sandbanks, gravel banks, shingle, or, less frequently, rocks.                  ___ The lagoon in which the wetland is located contains surface water that is saline or brackish (&gt; 0.5 ppt) during most of the year in at least a portion of the lagoon (<i>needs to be measured near the bottom.</i>)                  YES = Go to SC 5.1                      NO <u>X</u> not a wetland in a coastal lagoon                  SC 5.1 Does the wetland meet all of the following three conditions?                  ___ The wetland is relatively undisturbed (has no diking, ditching, filling, cultivation, grazing) and has less than 20% cover of invasive plant species (see list of invasive species on p. 74).                  ___ At least 3/4 of the landward edge of the wetland has a 100 ft. buffer of shrub, forest, or un-grazed or un-mowed grassland.                  ___ The wetland is larger than 1/10 acre (4350 square ft.)                  YES = Category I                      NO = Category II</p>	<p><b>Cat. I</b>  <b>Cat. II</b></p>
<p><b>SC6</b></p>	<p><b>Interdunal Wetlands</b> (see p. 93)                  Is the wetland west of the 1889 line (also called the Western Boundary of Upland Ownership or WBUO)?                  YES = Go to SC 6.1                      NO <u>X</u> not an interdunal wetland for rating  <i>If you answer yes you will still need to rate the wetland based on its functions.</i>                  In practical terms that means the following geographic areas:                  • Long Beach Peninsula -- lands west of SR 103                  • Grayland-Westport -- lands west of SR 105                  • Ocean Shores-Copalis – lands west of SR 115 and SR 109                  SC 6.1 Is the wetland one acre or larger, or is it in a mosaic of wetlands that is one acre or larger?                  YES = Category II                      NO = go to SC 6.2                  SC 6.2 Is the wetland between 0.1 and 1 acre, or is it in a mosaic of wetlands that is between 0.1 and 1 acre?                  YES = Category III</p>	<p><b>Cat. II</b>  <b>Cat. III</b></p>
<p>◆</p>	<p><b>Category of wetland based on Special Characteristics</b>                  Choose the "highest" rating if wetland falls into several categories, and record on p. 1.                  If you answered NO for all types enter "Not Applicable" on p. 1</p>	<p><b>NA</b></p>

Comments:



Wetland name or number 15D

**WETLAND RATING FORM – WESTERN WASHINGTON**  
Version 2 – Updated July 2006 to increase accuracy and reproducibility among users  
Updated Oct. 2008 with the new WDFW definitions for priority habitats

Name of wetland (if known): 15D Date of site visit: 01-30-09 & 09-12-13

Rated by: Colin Worsley / Matt Maynard Trained by Ecology? Yes X No      Date of training: 11-2005 / 04-2006

SEC: 07 TOWNSHIP: 24N RANGE: 06E Is S/T/R in Appendix D? Yes      No X

Map of wetland unit: Figure      Estimated size 0.05 acre

**SUMMARY OF RATING**

Category based on FUNCTIONS provided by wetland: I      II      III      IV X

Category I =	Score > 70
Category II =	Score 51 - 69
Category III =	Score 30 – 50
Category IV =	Score < 30

Score for Water Quality Functions	8
Score for Hydrologic Functions	10
Score for Habitat Functions	11
<b>TOTAL Score for Functions</b>	<b>29</b>

Category based on SPECIAL CHARACTERISTICS of Wetland I      II      Does not apply X

**Final Category** (choose the “highest” category from above”) **IV**

**Summary of basic information about the wetland unit.**

Wetland Unit has Special Characteristics		Wetland HGM Class used for Rating	
<b>Estuarine</b>		<b>Depressional</b>	<b>X</b>
<b>Natural Heritage Wetland</b>		<b>Riverine</b>	
<b>Bog</b>		<b>Lake-fringe</b>	
<b>Mature Forest</b>		<b>Slope</b>	
<b>Old Growth Forest</b>		<b>Flats</b>	
<b>Coastal Lagoon</b>		<b>Freshwater Tidal</b>	
<b>Interdunal</b>			
None of the above	X	Check if unit has multiple HGM classes present	<input type="checkbox"/>

**Does the wetland being rated meet any of the criteria below?** If you answer YES to any of the questions below you will need to protect the wetland according to the regulations regarding the special characteristics found in the wetland.

Check List for Wetlands that Need Additional Protection (in addition to the protection recommended for its category)	YES	NO
SP1. <i>Has the wetland unit been documented as a habitat for any Federally listed Threatened or Endangered <b>animal or plant</b> species (T/E species)?</i> For the purposes of this rating system, “documented” means the wetland is on the appropriate state or federal database.		X
SP2. <i>Has the wetland unit been documented as habitat for any State listed Threatened or Endangered <b>animal</b> species?</i> For the purposes of this rating system, “documented” means the wetland is on the appropriate state database. Note: Wetlands with State listed plant species are categorized as Category 1 Natural Heritage Wetlands (see p. 19 of data form).		X
SP3. <i>Does the wetland unit contain individuals of Priority species listed by the WDFW for the state?</i>		X
SP4. <i>Does the wetland unit have a local significance in addition to its functions?</i> For example, the wetland has been identified in the Shoreline Master Program, the Critical Areas Ordinance, or in a local management plan as having special significance.		X

To complete the next part of the data sheet you will need to determine the Hydrogeomorphic Class of the wetland being rated.

Exhibit 16  
SSDP2016-00415  
000980

### Classification of Vegetated Wetlands for Western Washington

If the hydrologic criteria listed in each question do not apply to the entire unit being rated, you probably have a unit with multiple HGM classes. In this case, identify which hydrologic criteria in questions 1-7 apply, and go to Question 8.

1. Are the water levels in the entire unit usually controlled by tides (i.e. except during floods)?  
NO – go to 2                      **YES – the wetland class is Tidal Fringe**  
 If yes, is the salinity of the water during periods of annual low flow below 0.5 ppt (parts per thousand)?  
**YES – Freshwater Tidal Fringe**                      **NO – Saltwater Tidal Fringe (Estuarine)**  
*If your wetland can be classified as a Freshwater Tidal Fringe use the forms for Riverine wetlands. If it is a Saltwater Tidal Fringe it is rated as an Estuarine wetland. Wetlands that were call estuarine in the first and second editions of the rating system are called Salt Water Tidal Fringe in the Hydrogeomorphic Classification. Estuarine wetlands were categorized separately in the earlier editions, and this separation is being kept in this revision. To maintain consistency between editions, the term “Estuarine” wetland is kept. Please note, however, that the characteristics that define Category I and II estuarine wetlands have changed (see p. \_\_\_\_\_).*

---

2. The entire wetland unit is flat and precipitation is only source (>90%) of water to it. Groundwater and surface water runoff are NOT sources of water to the unit.  
NO – go to 3                      **YES – The wetland class is Flats**  
 If your wetland can be classified as a “Flats” wetland, use the form for **Depressional** wetlands.

---

3. Does the entire wetland meet both of the following criteria?  
 \_\_\_\_\_ The vegetated part of the wetland is on the shores of a body of permanent open water (without any vegetation on the surface) where at least 20 acres (8ha) in size;  
 \_\_\_\_\_ At least 30% of the open water area is deeper than 6.6 (2 m)?  
NO – go to 4                      **YES – The wetland class is Lake-fringe (Lacustrine Fringe)**

---

4. Does the entire wetland meet all of the following criteria?  
 \_\_\_\_\_ The wetland is on a slope (*slope can be very gradual*).  
 \_\_\_\_\_ The water flows through the wetland in one direction (unidirectional) and usually comes from seeps. It may flow subsurface, as sheetflow, or in a swale without distinct banks.  
 \_\_\_\_\_ The water leaves the wetland **without being impounded**?  
 NOTE: *Surface water does not pond in these types of wetlands except occasionally in very small and shallow depressions or behind hummocks (depressions are usually <3 ft diameter and less than 1 foot deep).*  
NO – go to 5                      **YES – The wetland class is Slope**

---

5. Does the entire wetland meet all of the following criteria?  
 \_\_\_\_\_ The unit is in a valley or stream channel where it gets inundated by overbank flooding from that stream or river.  
 \_\_\_\_\_ The overbank flooding occurs at least once every two years.  
 NOTE: *The riverine unit can contain depressions that are filled with water when the river is not flooding..*  
NO – go to 6                      **YES – The wetland class is Riverine**

---

6. Is the entire wetland unit in a topographic depression in which water ponds, or is saturated to the surface, at some time of the year. This means that any outlet, if present is higher than the interior of the wetland.  
NO – go to 7                      **YES – The wetland class is Depressional**

---

7. Is the entire wetland located in a very flat area with no obvious depression and no overbank flooding. The unit does not pond surface water more than a few inches. The unit seems to be maintained by high groundwater in the area. The wetland may be ditched, but has no obvious natural outlet.  
No – go to 8                      **YES – The wetland class is Depressional**

---

8. Your wetland unit seems to be difficult to classify and probably contains several different HGM classes. For example, seeps at the base of a slope may grade into a riverine floodplain, or a small stream within a depressional wetland has a zone of flooding along its sides. **GO BACK AND IDENTIFY WHICH OF THE HYDROLOGIC REGIMES DESCRIBED IN QUESTIONS 1-7 APPLY TO DIFFERENT AREAS IN THE UNIT** (make a rough sketch to help you decide). Use the following table to identify the appropriate class to use for the rating system if you have several HGM classes present within your wetland. NOTE: Use this table only if the class that is recommended in the second column represents 10% or more of the total area of the wetland unit being rated. If the area of the class listed in column 2 is less than 10% of the unit, classify the wetland using the class that represents more than 90% of the total area.

HGM Classes within the wetland unit being rated	HGM Class to Use in Rating
Slope + Riverine	Riverine
Slope + Depressional	Depressional
Slope + Lake-fringe	Lake-fringe
Depressional + Riverine along stream within boundary	Depressional
Depressional + Lake-fringe	Depressional
Salt Water Tidal Fringe and any other class of freshwater wetland	Treat as ESTUARINE under wetlands with special characteristics

**Exhibit 16**  
**SSDP2016-00415**  
**000981**

If you are unable still to determine which of the above criteria apply to your wetland, or you have more than 2 HGM classes within a wetland boundary, classify the wetland as **Depressional** for the rating.

D Depressional and Flat Wetlands		Points
WATER QUALITY FUNCTIONS – Indicators that wetland functions to improve water quality.		(only 1 score per box) <i>(see p.38)</i>
<b>D 1</b>	<b>Does the wetland have the <u>potential</u> to improve water quality?</b>	
D 1.1	Characteristics of surface water flows out of the wetland: <ul style="list-style-type: none"> <li>• Unit is a depression with no surface water leaving it (no outlet) ..... points = 3</li> <li>• <b>Unit has an intermittently flowing, OR highly constricted, permanently flowing outlet ..... points = 2</b></li> <li>• Unit has an unconstricted, or slightly constricted, surface outlet (<i>permanently flowing</i>) ..... points = 1</li> <li>• Unit is a “flat” depression (Q.7 on key), or in the Flats class, with permanent surface outflow <b>and no obvious natural outlet</b> and/or outlet is a man-made ditch..... points = 1 (<i>If ditch is not permanently flowing treat unit as “intermittently flowing”</i>) <b>Provide photo or drawing</b></li> </ul>	Figure ____  2
D 1.2	The soil 2 inches below the surface (or duff layer) is clay or organic ( <i>use NRCS definitions</i> ) YES points = 4    NO points = 0	
D 1.3	Characteristics of persistent vegetation (emergent, shrub, and/or forest Cowardin class): <ul style="list-style-type: none"> <li>• Wetland has persistent, ungrazed vegetation &gt; = 95% of area..... points = 5</li> <li>• Wetland has persistent, ungrazed vegetation &gt; = 1/2 of area..... points = 3</li> <li>• Wetland has persistent, ungrazed vegetation &gt; = 1/10 of area..... points = 1</li> <li>• <b>Wetland has persistent, ungrazed vegetation &lt; 1/10 of area..... points = 0</b></li> </ul> <b>Map of Cowardin vegetation classes</b>	Figure ____  0
D 1.4	Characteristics of seasonal ponding or inundation: <i>This is the area of the wetland that is ponded for at least 2 months, but dries out sometime during the year. Do not count the area that is permanently ponded. Estimate area as the average condition 5 out of 10 years.</i> <ul style="list-style-type: none"> <li>• Area seasonally ponded is &gt; 1/2 total area of wetland ..... points = 4</li> <li>• <b>Area seasonally ponded is &gt; 1/4 total area of wetland ..... points = 2</b></li> <li>• Area seasonally ponded is &lt; 1/4 total area of wetland ..... points = 0</li> </ul> <b>Map of Hydroperiods</b>	Figure ____  2
<b>Total for D 1</b>		<i>Add the points in the boxes above</i> <b>4</b>
<b>D 2</b>	<b>Does the wetland have the <u>opportunity</u> to improve water quality?</b> Answer YES if you know or believe there are pollutants in groundwater or surface water coming into the wetland that would otherwise reduce water quality in streams, lakes or groundwater downgradient from the wetland? <i>Note which of the following conditions provide the sources of pollutants. A unit may have pollutants coming from several sources, but any single source would qualify as opportunity.</i> <ul style="list-style-type: none"> <li>____ Grazing in the wetland or within 150 ft</li> <li>____ Untreated stormwater discharges to wetland</li> <li>____ Tilled fields or orchards within 150 ft. of wetland</li> <li>____ A stream or culvert discharges into wetland that drains developed areas, residential areas, farmed fields, roads, or clear-cut logging</li> <li><input checked="" type="checkbox"/> Residential, urban areas, golf courses are within 150 ft. of wetland</li> <li>____ Wetland is fed by groundwater high in phosphorus or nitrogen</li> <li>____ Other _____</li> </ul> YES multiplier is <b>2</b> NO multiplier is 1	<i>(see p. 44)</i>          Multiplier  <b>X2</b>
<b>◆ TOTAL – Water Quality Functions</b> Multiply the score from D1 by D2; then <i>add score to table on p. 1</i>		<b>8</b>
HYDROLOGIC FUNCTIONS – Indicators that wetland unit functions to reduce flooding and stream degradation.		
<b>D 3</b>	<b>Does the wetland have the <u>potential</u> to reduce flooding and erosion?</b>	<i>(see p.46)</i>
D 3.1	Characteristics of surface water flows out of the wetland unit <ul style="list-style-type: none"> <li>• Unit is a depression with no surface water leaving it (no outlet)..... points = 4</li> <li>• <b>Unit has an intermittently flowing, OR highly constricted permanently flowing outlet ..... points = 2</b></li> <li>• Unit is a “flat” depression (Q.7 on key) or in the Flats class, with permanent surface outflow <b>and no obvious natural outlet</b> and/or outlet is a man-made ditch..... points = 1 (<i>If ditch is not permanently flowing treat unit as “intermittently flowing”</i>)</li> <li>• Unit has an unconstricted, or slightly constricted, surface outlet (<i>permanently flowing</i>) ..... points = 0</li> </ul>	2
D 3.2	Depth of storage during wet periods. <i>Estimate the height of ponding above the bottom of the outlet. For units with no outlet measure from the surface of permanent water or deepest part (if dry).</i> <ul style="list-style-type: none"> <li>• Marks of ponding are 3 ft. or more above the surface or bottom of the outlet ..... points = 7</li> <li>• The wetland is a “headwater” wetland..... points = 5</li> <li>• Marks of ponding between 2 ft. to &lt; 3 ft. from surface or bottom of outlet ..... points = 5</li> <li>• Marks are at least 0.5 ft. to &lt; 2 ft. from surface or bottom of outlet ..... points = 3</li> <li>• Wetland is flat (yes to Q.2 or Q.7 on key)but has small depressions on the surface that trap water points = 1</li> <li>• <b>Marks of ponding less than 0.5 ft ..... points = 0</b></li> </ul>	0
D 3.3	Contribution of wetland unit to storage in the watershed: <i>Estimate the ratio of the area of upstream basin contributing surface water to the wetland to the area of the wetland unit itself.</i> <ul style="list-style-type: none"> <li>• The area of the basin is less than 10 times the area of unit..... points = 5</li> <li>• <b>The area of the basin is 10 to 100 times the area of the unit ..... points = 3</b></li> <li>• The area of the basin is more than 100 times the area of the unit ..... points = 0</li> <li>• Entire unit is in the FLATS class ..... points = 5</li> </ul>	3
<b>Total for D 3</b>		<i>Add the points in the boxes above</i> <b>5</b>

**Exhibit 16**  
**SSDP2016-00415**  
**000982**

<b>D 4</b>	<p><b>Does the wetland have the <u>opportunity</u> to reduce flooding and erosion?</b></p> <p>Answer YES if the unit is in a location in the watershed where the flood storage, or reduction in water velocity, it provides helps protect downstream property and aquatic resources from flooding or excessive and/or erosive flows. Answer NO if the water coming into the wetland is controlled by a structure such as flood gate, tide gate, flap valve, reservoir etc. OR you estimate that more than 90% of the water in the wetland is from groundwater in areas where damaging groundwater flooding does not occur. <i>Note which of the following indicators of opportunity apply.</i></p> <p><input type="checkbox"/> Wetland is in a headwater of a river or stream that has flooding problems.</p> <p><input checked="" type="checkbox"/> Wetland drains to a river or stream that has flooding problems</p> <p><input type="checkbox"/> Wetland has no outlet and impounds surface runoff water that might otherwise flow into a river or stream that has flooding problems</p> <p><input type="checkbox"/> Other _____</p> <p><b>YES multiplier is 2</b>                      NO multiplier is 1</p>	<p>(see p. 49)</p> <p>Multiplier X2</p>
◆	<p><b>TOTAL – Hydrologic Functions</b>                      Multiply the score from D3 by D4; then <i>add score to table on p. 1</i></p>	<p>10</p>

Comments:





These questions apply to wetlands of all HGM classes.		Points
HABITAT FUNCTIONS – Indicators that wetland functions to provide important habitat.		(only 1 score per box)
<b>H 1</b>	<b>Does the wetland have the <u>potential</u> to provide habitat for many species?</b>	
H 1.1	<p><b>Vegetation structure</b> (see P. 72):                      Check the types of vegetation classes present (as defined by Cowardin) – Size threshold for each class is 1/4 acre or more than 10% of the area if unit is smaller than 2.5 acres.</p> <p><input type="checkbox"/> Aquatic Bed  <input checked="" type="checkbox"/> Emergent plants  <input type="checkbox"/> Scrub/shrub (areas where shrubs have &gt; 30% cover)  <input type="checkbox"/> Forested (areas where trees have &gt; 30% cover)</p> <p>If the unit has a forested class check if:  <input type="checkbox"/> The forested class has 3 out of 5 strata (canopy, sub-canopy, shrubs, herbaceous, moss/ground-cover) that each cover 20% within the forested polygon.                      Add the number of vegetation types that qualify. If you have:</p> <p style="text-align: right;"><b>Map of Cowardin vegetation classes</b></p> <p style="text-align: right;">4 structures or more..... points = 4                      3 structures ..... points = 2                      1 structure ..... points = 0</p>	<p>Figure ____</p> <p style="text-align: center;">0</p>
H 1.2	<p><b>Hydroperiods</b> (see p.73):                      Check the types of water regimes (hydroperiods) present within the wetland. The water regime has to cover more than 10% of the wetland or 1/4 acre to count (see text for descriptions of hydroperiods).</p> <p><input checked="" type="checkbox"/> Permanently flooded or inundated  <input checked="" type="checkbox"/> Seasonally flooded or inundated  <input checked="" type="checkbox"/> Occasionally flooded or inundated  <input checked="" type="checkbox"/> Saturated only</p> <p><input type="checkbox"/> Permanently flowing stream or river in, or adjacent to, the wetland  <input type="checkbox"/> Seasonally flowing stream in, or adjacent to, the wetland  <input type="checkbox"/> <b>Lake-fringe wetland..... = 2 points</b>  <input type="checkbox"/> <b>Freshwater tidal wetland..... = 2 points</b></p> <p style="text-align: right;"><b>Map of hydroperiods</b></p> <p style="text-align: right;">4 or more types present points = 3  <b>3 or more types present..... points = 2</b>                      2 types present..... points = 1                      1 type present ..... points = 0</p>	<p>Figure ____</p> <p style="text-align: center;">2</p>
H 1.3	<p><b>Richness of Plant Species</b> (see p. 75):                      Count the number of plant species in the wetland that cover at least 10 ft<sup>2</sup> (different patches of the same species can be combined to meet the size threshold)                      You do not have to name the species. Do not include Eurasian Milfoil, reed canarygrass, purple loosestrife, Canadian Thistle.</p> <p>If you counted: &gt; 19 species ..... points = 2  <b>5 – 19 species..... points = 1</b>                      &lt; 5 species ..... points = 0</p> <p>List species below if you want to:                      _____                      _____                      _____</p>	<p>Figure ____</p> <p style="text-align: center;">1</p>
H 1.4	<p><b>Interspersion of Habitats</b> (see p. 76):                      Decided from the diagrams below whether interspersion between Cowardin vegetation (described in H1.1), or the classes and unvegetated areas (can include open water or mudflats) is high, medium, low, or <b>none</b>.</p> <div style="display: flex; justify-content: space-around;"> <div style="text-align: center;">  <p>None = 0 points</p> </div> <div style="text-align: center;">  <p>Low = 1 point</p> </div> <div style="text-align: center;">  <p>Moderate = 2 points</p> </div> <div style="text-align: center;">  <p>High = 3 points</p> </div> </div> <p style="text-align: center;">[riparian braided channels]</p> <p>Note: If you have 4 or more classes or 3 vegetation classes and open water, the rating is always “high”.</p> <p style="text-align: right;"><b>Use map of Cowardin classes.</b></p>	<p>Figure ____</p> <p style="text-align: center;">0</p>
H 1.5	<p><b>Special Habitat Features</b> (see p. 77):                      Check the habitat features that are present in the wetland. The number of checks is the number of points you put into the next column.</p> <p><input type="checkbox"/> Large, downed, woody debris within the wetland (&gt; 4 in. diameter and 6 ft. long)  <input type="checkbox"/> Standing snags (diameter at the bottom &gt; 4 inches) in the wetland  <input type="checkbox"/> Undercut banks are present for at least 6.6 ft. (2m) and/or overhanging vegetation extends at least 3.3 ft. (1m) over a stream (or ditch) in, or contiguous with the unit, for at least 33 ft. (10m)  <input type="checkbox"/> Stable steep banks of fine material that might be used by beaver or muskrat for denning (&gt; 30 degree slope) OR signs of recent beaver activity are present (cut shrubs or trees that have not yet turned grey/brown)  <input type="checkbox"/> At least 1/4 acre of thin-stemmed persistent vegetation or woody branches are present in areas that are permanently or seasonally inundated (structures for egg-laying by amphibians)  <input type="checkbox"/> Invasive plants cover less than 25% of the wetland area in each stratum of plants</p> <p>NOTE: The 20% stated in early printings of the manual on page 78 is an error.</p>	<p>Figure ____</p> <p style="text-align: center;">0</p>
<b>H 1 TOTAL Score</b> – potential for providing habitat		3

Exhibit 16  
 SSP 2015-00215  
 000984

H 2	Does the wetland have the <u>opportunity</u> to provide habitat for many species?	(only 1 score per box)
	<p>H 2.1 <u>Buffers</u> (see P. 80):  <i>Choose the description that best represents condition of buffer of wetland unit. The highest scoring criterion that applies to the wetland is to be used in the rating. See text for definition of “undisturbed”.</i></p> <p><input type="checkbox"/> 100m (330 ft) of relatively undisturbed vegetated areas, rocky areas, or open water &gt; 95% of circumference. No structures are within the undisturbed part of buffer (relatively undisturbed also means no grazing, no landscaping, no daily human use)..... <b>points = 5</b></p> <p><input type="checkbox"/> 100m (330 ft) of relatively undisturbed vegetated areas, rocky areas, or open water &gt; 50% circumference ..... <b>points = 4</b></p> <p><input type="checkbox"/> 50m (170 ft) of relatively undisturbed vegetated areas, rocky areas, or open water &gt; 95% circumference ..... <b>points = 4</b></p> <p><input type="checkbox"/> 100m (330 ft) of relatively undisturbed vegetated areas, rocky areas, or open water &gt; 25% circumference ..... <b>points = 3</b></p> <p><input type="checkbox"/> 50m (170 ft) of relatively undisturbed vegetated areas, rocky areas, or open water for &gt; 50% circumference ..... <b>points = 3</b></p> <p><b>If buffer does not meet any of the criteria above:</b></p> <p><input type="checkbox"/> No paved areas (except paved trails) or buildings within 25m (80 ft) of wetland &gt; 95% circumference. Light to moderate grazing or lawns are OK ..... <b>points = 2</b></p> <p><input type="checkbox"/> No paved areas of buildings within 50m of wetland for &gt; 50% circumference. Light to moderate grazing or lawns are OK..... <b>points = 2</b></p> <p><input type="checkbox"/> Heavy grazing in buffer ..... <b>points = 1</b></p> <p><input type="checkbox"/> Vegetated buffers are &lt; 2m wide (6.6 ft) for more than 95% circumference (e.g. tilled fields, paving, basalt bedrock extend to edge of wetland) ..... <b>points = 0</b></p> <p><input checked="" type="checkbox"/> Buffer does not meet any of the criteria above ..... <b>points = 1</b></p> <p style="text-align: right;"><b>Arial photo showing buffers</b></p>	<p>Figure ____</p> <p style="text-align: center;">1</p>
	<p>H 2.2 <u>Corridors and Connections</u> (see p. 81)</p> <p>H 2.2.1 Is the wetland part of a relatively undisturbed and unbroken vegetated corridor (either riparian or upland) that is at least 150 ft. wide, has at least a 30% cover of shrubs, forest or native undisturbed prairie, that connects to estuaries, other wetlands or undisturbed uplands that are at least 250 acres in size? (<i>Dams in riparian corridors, heavily used gravel roads, paved roads, are considered breaks in the corridor.</i>)                  YES = <b>4 points</b> (go to H 2.3) <span style="float: right;"><b>NO = go to H 2.2.2</b></span></p> <p>H. 2.2.2 Is the wetland part of a relatively undisturbed and unbroken vegetated corridor (either riparian or upland) that is at least 50 ft. wide, has at least 30% cover of shrubs or forest, and connects to estuaries, other wetlands or undisturbed uplands that are at least 25 acres in size? <b>OR a Lake-fringe</b> wetland, if it does not have an undisturbed corridor as in the question above?                  YES = <b>2 points</b> (go to H 2.3) <span style="float: right;"><b>NO = go to H 2.2.3</b></span></p> <p>H. 2.2.3 Is the wetland:  <ul style="list-style-type: none"> <li>• Within 5 mi (8km) of a brackish or salt water estuary OR</li> <li>• Within 3 miles of a large field or pasture (&gt; 40 acres) OR <span style="float: right;"><b>YES = 1 point</b></span></li> <li>• <b>Within 1 mile of a lake greater than 20 acres?</b> <span style="float: right;"><b>NO = 0 points</b></span></li> </ul> </p>	<p style="text-align: center;">1</p>

Comments:

	<p>H 2.3 <u>Near or adjacent to other priority habitats listed by WDFW</u> (see p. 82): (see new and complete descriptions of WDFW priority habitats, and the counties in which they can be found, in the PHS report <a href="http://wdfw.wa.gov/hab/phslist.htm">http://wdfw.wa.gov/hab/phslist.htm</a> )</p> <p>Which of the following priority habitats are within 330 ft. (100m) of the wetland unit?  <i>NOTE: the connections do not have to be relatively undisturbed.</i></p> <p><input type="checkbox"/> <b>Aspen Stands:</b> Pure or mixed stands of aspen greater than 0.4 ha (1 acre).</p> <p><input type="checkbox"/> <b>Biodiversity Areas and Corridors:</b> Areas of habitat that are relatively important to various species of native fish and wildlife (full descriptions in WDFW PHS report p. 152).</p> <p><input type="checkbox"/> <b>Herbaceous Balds:</b> Variable size patches of grass and forbs on shallow soils over bedrock.</p> <p><input type="checkbox"/> <b>Old-growth/Mature forests:</b> (Old-growth west of Cascade crest) Stands of at least 2 tree species, forming a multi-layered canopy with occasional small openings; with at least 20 trees/ha (8 trees/acre) &gt; 81 cm (32 in) dbh or &gt; 200 years of age. (Mature forests) Stands with average diameters exceeding 53 cm (21 in) dbh; crown cover may be less than 100%; decay, decadence, numbers of snags, and quantity of large downed material is generally less than that found in old-growth; 80 - 200 years old west of the Cascade crest.</p> <p><input type="checkbox"/> <b>Oregon white Oak:</b> Woodlands Stands of pure oak or oak/conifer associations where canopy coverage of the oak component is important (full descriptions in WDFW PHS report p. 158).</p> <p><input checked="" type="checkbox"/> <b>Riparian:</b> The area adjacent to aquatic systems with flowing water that contains elements of both aquatic and terrestrial ecosystems which mutually influence each other.</p> <p><input type="checkbox"/> <b>Westside Prairies:</b> Herbaceous, non-forested plant communities that can either take the form of a dry prairie or a wet prairie (full descriptions in WDFW PHS report p. 161).</p> <p><input checked="" type="checkbox"/> <b>Instream:</b> The combination of physical, biological, and chemical processes and conditions that interact to provide functional life history requirements for instream fish and wildlife resources.</p> <p><input type="checkbox"/> <b>Nearshore:</b> Relatively undisturbed nearshore habitats. These include Coastal Nearshore, Open Coast Nearshore, and Puget Sound Nearshore. (full descriptions of habitats and the definition of relatively undisturbed are in WDFW report: pp. 167-169 and glossary in Appendix A).</p> <p><input type="checkbox"/> <b>Caves:</b> A naturally occurring cavity, recess, void, or system of interconnected passages under the earth in soils, rock, ice, or other geological formations and is large enough to contain a human.</p> <p><input type="checkbox"/> <b>Cliffs:</b> Greater than 7.6 m (25 ft) high and occurring below 5000 ft.</p> <p><input type="checkbox"/> <b>Talus:</b> Homogenous areas of rock rubble ranging in average size 0.15 - 2.0 m (0.5 - 6.5 ft), composed of basalt, andesite, and/or sedimentary rock, including riprap slides and mine tailings. May be associated with cliffs.</p> <p><input type="checkbox"/> <b>Snags and Logs:</b> Trees are considered snags if they are dead or dying and exhibit sufficient decay characteristics to enable cavity excavation/use by wildlife. Priority snags have a diameter at breast height of &gt; 51 cm (20 in) in western Washington and are &gt; 2 m (6.5 ft) in height. Priority logs are &gt; 30 cm (12 in) in diameter at the largest end, and &gt; 6 m (20 ft) long.</p> <p>If wetland has <b>3 or more</b> priority habitats = <b>4 points</b>  <b>If wetland has 2</b> priority habitats = <b>3 points</b>                  If wetland has <b>1</b> priority habitat = <b>1 point</b>                      No habitats = 0 points</p> <p>Note: All vegetated wetlands are by definition a priority habitat but are not included in this list. Nearby wetlands are addressed in question H 2.4)</p>	3
	<p>H 2.4 <u>Wetland Landscape:</u> Choose the <b>one</b> description of the landscape around the wetland that best fits (see p. 84)</p> <ul style="list-style-type: none"> <li>• There are at least 3 other wetlands within 1/2 mile, and the connections between them are relatively undisturbed (light grazing between wetlands OK, as is lake shore with some boating, but connections should NOT be bisected by paved roads, fill, fields, or other development.....points = 5</li> <li>• The wetland is Lake-fringe on a lake with little disturbance and there are 3 other lake-fringe wetlands within 1/2 mile .....points = 5</li> <li>• <b>There are at least 3 other wetlands within 1/2 mile, BUT the connections between them are disturbed.....points = 3</b></li> <li>• The wetland fringe on a lake <b>with</b> disturbance and there are 3 other lake-fringe wetlands within 1/2 mile .....points = 3</li> <li>• There is at least 1 wetland within 1/2 mile .....points = 2</li> <li>• There are no wetlands within 1/2 mile.....points = 0</li> </ul>	3
	<p><b>H 2 TOTAL Score</b> – opportunity for providing habitat                      Add the scores from H2.1, H2.2, H2.3, H2.4</p>	8
	<p style="text-align: right;">TOTAL for H 1 from page 8</p>	3
◆	<p><b>Total Score for Habitat Functions</b>                      Add the points for H 1 and H 2; then <b>record the result on p. 1</b></p>	11

Comments:

### CATEGORIZATION BASED ON SPECIAL CHARACTERISTICS

*Please determine if the wetland meets the attributes described below  
and circle the appropriate answers and Category.*

Wetland Type – Check off any criteria that apply to the wetland. Circle the Category when the appropriate criteria are met.		
<b>SC1</b>	<p><b>Estuarine wetlands?</b> (see p.86)</p> <p>Does the wetland unit meet the following criteria for Estuarine wetlands?</p> <p><input type="checkbox"/> The dominant water regime is tidal,  <input type="checkbox"/> Vegetated, and  <input type="checkbox"/> With a salinity greater than 0.5 ppt.</p> <p style="text-align: center;">YES = Go to SC 1.1                      NO = <u>X</u></p>	
SC 1.1	<p>Is the wetland unit within a National Wildlife Refuge, National Park, National Estuary Reserve, Natural Area Preserve, State Park or Educational, Environmental, or Scientific Reserve designated under WAC 332-30-151?      YES = Category I                      NO = go to SC 1.2</p>	<b>Cat. I</b>
SC 1.2	<p>Is the wetland at least 1 acre in size and meets at least two of the following conditions?</p> <p style="text-align: center;">YES = Category I                      NO = Category II</p> <p><input type="checkbox"/> The wetland is relatively undisturbed (has no diking, ditching, filling, cultivation, grazing, and has less than 10% cover of non-native plant species. If the non-native <i>Spartina</i> spp., are only species that cover more than 10% of the wetland, then the wetland should be given a dual rating (I/II). The area of <i>Spartina</i> would be rated a Category II while the relatively undisturbed upper marsh with native species would be a Category I. Do not, however, exclude the area of <i>Spartina</i> in determining the size threshold of 1 acre.</p> <p><input type="checkbox"/> At least 3/4 of the landward edge of the wetland has a 100 ft. buffer of shrub, forest, or un-grazed or un-mowed grassland</p> <p><input type="checkbox"/> The wetland has at least 2 of the following features: tidal channels, depressions with open water, or contiguous freshwater wetlands.</p>	<b>Cat. I</b> <b>Cat. II</b>  <b>Dual Rating I/II</b>
<b>SC2</b>	<p><b>Natural Heritage Wetlands</b> (see p. 87)</p> <p>Natural Heritage wetlands have been identified by the Washington Natural Heritage Program/DNR as either high quality undisturbed wetlands or wetlands that support state Threatened, Endangered, or Sensitive plant species.</p> <p>SC 2.1 Is the wetland being rated in a Section/Township/Range that contains a natural heritage wetland? (This question is used to screen out most sites before you need to contact WNHP/DNR.)</p> <p style="text-align: center;">S/T/R information from Appendix D _____ or accessed from WNHP/DNR web site _____</p> <p style="text-align: center;">YES _____ Contact WNHP/DNR (see p. 79) and go to SC 2.2                      NO = <u>X</u></p> <p>SC 2.2 Has DNR identified the wetland as a high quality undisturbed wetland or as a site with state threatened or endangered plant species?</p> <p style="text-align: center;">YES = Category 1                      NO _____ not a Heritage Wetland</p>	<b>Cat I</b>
<b>SC3</b>	<p><b>Bogs</b> (see p. 87)</p> <p>Does the wetland (or any part of the unit) meet both the criteria for soils and vegetation in bogs? Use the key below to identify if the wetland is a bog. <i>If you answer yes you will still need to rate the wetland based on its function.</i></p> <ol style="list-style-type: none"> <li>1. Does the unit have organic soil horizons (i.e. layers of organic soil), either peats or mucks, that compose 16 inches or more of the first 32 inches of soil profile? (See Appendix B for a field key to identify organic soils)?      YES = go to question 3      <b>NO = go to question 2</b></li> <li>2. Does the wetland have organic soils, either peats or mucks that are less than 16 inches deep over bedrock, or an impermeable hardpan such as clay or volcanic ash, or that are floating on a lake or pond?      YES = go to question 3      <b>NO = is not a bog for purpose of rating</b></li> <li>3. Does the unit have more than 70% cover of mosses at ground level, AND other plants, if present, consist of the “bog” species listed in Table 3 as a significant component of the vegetation (more than 30% of the total shrub and herbaceous cover consists of species in Table 3)?</li> </ol> <p style="text-align: center;">YES = Is a bog for purpose of rating                      NO = go to question 4</p> <p>NOTE: If you are uncertain about the extent of mosses in the understory you may substitute that criterion by measuring the pH of the water that seeps into a hole dug at least 16” deep. If the pH is less than 5.0 and the “bog” plant species in Table 3 are present, the wetland is a bog.</p> <ol style="list-style-type: none"> <li>4. Is the unit forested (&gt; 30% cover) with sitka spruce, subalpine fir, western red cedar, western hemlock, lodgepole pine, quaking aspen, Englemann’s spruce, or western white pine. WITH any of the species (or combination of species) on the bog species plant list in Table 3 as a significant component of the ground cover (&gt; 30% coverage of the total shrub/herbaceous cover)?</li> </ol> <p style="text-align: center;">YES = Category I                      NO = Is not a bog for purpose of rating</p>	<b>Cat. I</b>

**Exhibit 16**  
**SSDP2016-00415**  
**000987**



SC4	<p><b>Forested Wetlands</b> (see p. 90)</p> <p>Does the wetland have at least 1 acre of forest that meet one of these criteria for the Department of Fish and Wildlife's forests as priority habitats? <i>If you answer yes you will still need to rate the wetland based on its function.</i></p> <p>___ <b>Old-growth forests:</b> (west of Cascade Crest) Stands of at least two three species forming a multi-layered canopy with occasional small openings; with at least 8 trees/acre (20 trees/hectare) that are at least 200 years of age OR have a diameter at breast height (dbh) of 32 inches (81 cm or more).</p> <p>NOTE: The criterion for dbh is based on measurements for upland forests. Two-hundred year old trees in wetlands will often have a smaller dbh because their growth rates are often slower. The DFW criterion is and "OR" so old-growth forests do not necessarily have to have trees of this diameter.</p> <p>___ <b>Mature forests:</b> (west of the Cascade Crest) Stands where the largest trees are 80 – 200 years old OR have an average diameters (dbh) exceeding 21 inches (53 cm); crown cover may be less than 100%; decay, decadence, numbers of snags, and quantity of large downed material is generally less than that found in old-growth.</p> <p>YES = Category I                      NO = <u>X</u> not a forested wetland with special characteristics</p>	Cat. I
SC5	<p><b>Wetlands in Coastal Lagoons</b> (see p. 91)</p> <p>Does the wetland meet all of the following criteria of a wetland in a coastal lagoon?</p> <p>___ The wetland lies in a depression adjacent to marine waters that is wholly or partially separated from marine waters by sandbanks, gravel banks, shingle, or, less frequently, rocks.</p> <p>___ The lagoon in which the wetland is located contains surface water that is saline or brackish (&gt; 0.5 ppt) during most of the year in at least a portion of the lagoon (<i>needs to be measured near the bottom.</i>)</p> <p>YES = Go to SC 5.1                      NO <u>X</u> not a wetland in a coastal lagoon</p> <p>SC 5.1 Does the wetland meet all of the following three conditions?</p> <p>___ The wetland is relatively undisturbed (has no diking, ditching, filling, cultivation, grazing) and has less than 20% cover of invasive plant species (see list of invasive species on p. 74).</p> <p>___ At least 3/4 of the landward edge of the wetland has a 100 ft. buffer of shrub, forest, or un-grazed or un-mowed grassland.</p> <p>___ The wetland is larger than 1/10 acre (4350 square ft.)</p> <p>YES = Category I                      NO = Category II</p>	Cat. I Cat. II
SC6	<p><b>Interdunal Wetlands</b> (see p. 93)</p> <p>Is the wetland west of the 1889 line (also called the Western Boundary of Upland Ownership or WBUO)?</p> <p>YES = Go to SC 6.1                      NO <u>X</u> not an interdunal wetland for rating</p> <p><i>If you answer yes you will still need to rate the wetland based on its functions.</i></p> <p>In practical terms that means the following geographic areas:</p> <ul style="list-style-type: none"> <li>• Long Beach Peninsula -- lands west of SR 103</li> <li>• Grayland-Westport -- lands west of SR 105</li> <li>• Ocean Shores-Copalis – lands west of SR 115 and SR 109</li> </ul> <p>SC 6.1 Is the wetland one acre or larger, or is it in a mosaic of wetlands that is one acre or larger?</p> <p>YES = Category II                      NO = go to SC 6.2</p> <p>SC 6.2 Is the wetland between 0.1 and 1 acre, or is it in a mosaic of wetlands that is between 0.1 and 1 acre?</p> <p>YES = Category III</p>	Cat. II Cat. III
◆	<p><b>Category of wetland based on Special Characteristics</b></p> <p>Choose the "highest" rating if wetland falls into several categories, and record on p. 1.</p> <p>If you answered NO for all types enter "Not Applicable" on p. 1</p>	NA

Comments:

**Exhibit 16**  
**SSDP2016-00415**  
**000988**

Wetland name or number 15E

**WETLAND RATING FORM – WESTERN WASHINGTON**  
Version 2 – Updated July 2006 to increase accuracy and reproducibility among users  
Updated Oct. 2008 with the new WDFW definitions for priority habitats

Name of wetland (if known): 15E Date of site visit: 01-30-09 & 09-12-13

Rated by: Colin Worsley / Matt Maynard Trained by Ecology? Yes X No      Date of training: 11-2005 / 04-2006

SEC: 07 TOWNSHIP: 24N RANGE: 06E Is S/T/R in Appendix D? Yes      No X

Map of wetland unit: Figure      Estimated size 0.05 acre

**SUMMARY OF RATING**

Category based on FUNCTIONS provided by wetland: I      II      III      IV X

Category I =	Score > 70
Category II =	Score 51 - 69
Category III =	Score 30 – 50
Category IV =	Score < 30

Score for Water Quality Functions	4
Score for Hydrologic Functions	14
Score for Habitat Functions	10
<b>TOTAL Score for Functions</b>	<b>28</b>

Category based on SPECIAL CHARACTERISTICS of Wetland I      II      Does not apply X

**Final Category** (choose the “highest” category from above)

**IV**

**Summary of basic information about the wetland unit.**

Wetland Unit has Special Characteristics		Wetland HGM Class used for Rating	
<b>Estuarine</b>		<b>Depressional</b>	<b>X</b>
<b>Natural Heritage Wetland</b>		<b>Riverine</b>	
<b>Bog</b>		<b>Lake-fringe</b>	
<b>Mature Forest</b>		<b>Slope</b>	
<b>Old Growth Forest</b>		<b>Flats</b>	
<b>Coastal Lagoon</b>		<b>Freshwater Tidal</b>	
<b>Interdunal</b>			
None of the above	X	Check if unit has multiple HGM classes present	

**Does the wetland being rated meet any of the criteria below?** If you answer YES to any of the questions below you will need to protect the wetland according to the regulations regarding the special characteristics found in the wetland.

Check List for Wetlands that Need Additional Protection (in addition to the protection recommended for its category)		YES	NO
SP1. <i>Has the wetland unit been documented as a habitat for any Federally listed Threatened or Endangered <b>animal or plant</b> species (T/E species)?</i> For the purposes of this rating system, “documented” means the wetland is on the appropriate state or federal database.			X
SP2. <i>Has the wetland unit been documented as habitat for any State listed Threatened or Endangered <b>animal</b> species?</i> For the purposes of this rating system, “documented” means the wetland is on the appropriate state database. Note: Wetlands with State listed plant species are categorized as Category 1 Natural Heritage Wetlands (see p. 19 of data form).			X
SP3. <i>Does the wetland unit contain individuals of Priority species listed by the WDFW for the state?</i>			X
SP4. <i>Does the wetland unit have a local significance in addition to its functions?</i> For example, the wetland has been identified in the Shoreline Master Program, the Critical Areas Ordinance, or in a local management plan as having special significance.			X

To complete the next part of the data sheet you will need to determine the Hydrogeomorphic Class of the wetland being rated.

Exhibit 16  
SSDP2016-00415  
000909

### Classification of Vegetated Wetlands for Western Washington

If the hydrologic criteria listed in each question do not apply to the entire unit being rated, you probably have a unit with multiple HGM classes. In this case, identify which hydrologic criteria in questions 1-7 apply, and go to Question 8.

1. Are the water levels in the entire unit usually controlled by tides (i.e. except during floods)?  
NO – go to 2                      **YES – the wetland class is Tidal Fringe**  
 If yes, is the salinity of the water during periods of annual low flow below 0.5 ppt (parts per thousand)?  
**YES – Freshwater Tidal Fringe**                      **NO – Saltwater Tidal Fringe (Estuarine)**  
*If your wetland can be classified as a Freshwater Tidal Fringe use the forms for Riverine wetlands. If it is a Saltwater Tidal Fringe it is rated as an Estuarine wetland. Wetlands that were call estuarine in the first and second editions of the rating system are called Salt Water Tidal Fringe in the Hydrogeomorphic Classification. Estuarine wetlands were categorized separately in the earlier editions, and this separation is being kept in this revision. To maintain consistency between editions, the term “Estuarine” wetland is kept. Please note, however, that the characteristics that define Category I and II estuarine wetlands have changed (see p. \_\_\_\_).*

---

2. The entire wetland unit is flat and precipitation is only source (>90%) of water to it. Groundwater and surface water runoff are NOT sources of water to the unit.  
NO – go to 3                      **YES – The wetland class is Flats**  
 If your wetland can be classified as a “Flats” wetland, use the form for **Depressional** wetlands.

---

3. Does the entire wetland meet both of the following criteria?  
 \_\_\_\_\_ The vegetated part of the wetland is on the shores of a body of permanent open water (without any vegetation on the surface) where at least 20 acres (8ha) in size;  
 \_\_\_\_\_ At least 30% of the open water area is deeper than 6.6 (2 m)?  
NO – go to 4                      **YES – The wetland class is Lake-fringe (Lacustrine Fringe)**

---

4. Does the entire wetland meet all of the following criteria?  
 \_\_\_\_\_ The wetland is on a slope (*slope can be very gradual*).  
 \_\_\_\_\_ The water flows through the wetland in one direction (unidirectional) and usually comes from seeps. It may flow subsurface, as sheetflow, or in a swale without distinct banks.  
 \_\_\_\_\_ The water leaves the wetland **without being impounded**?  
 NOTE: *Surface water does not pond in these types of wetlands except occasionally in very small and shallow depressions or behind hummocks (depressions are usually <3 ft diameter and less than 1 foot deep).*  
NO – go to 5                      **YES – The wetland class is Slope**

---

5. Does the entire wetland meet all of the following criteria?  
 \_\_\_\_\_ The unit is in a valley or stream channel where it gets inundated by overbank flooding from that stream or river.  
 \_\_\_\_\_ The overbank flooding occurs at least once every two years.  
 NOTE: *The riverine unit can contain depressions that are filled with water when the river is not flooding..*  
NO – go to 6                      **YES – The wetland class is Riverine**

---

6. Is the entire wetland unit in a topographic depression in which water ponds, or is saturated to the surface, at some time of the year. This means that any outlet, if present is higher than the interior of the wetland.  
NO – go to 7                      **YES – The wetland class is Depressional**

---

7. Is the entire wetland located in a very flat area with no obvious depression and no overbank flooding. The unit does not pond surface water more than a few inches. The unit seems to be maintained by high groundwater in the area. The wetland may be ditched, but has no obvious natural outlet.  
No – go to 8                      **YES – The wetland class is Depressional**

---

8. Your wetland unit seems to be difficult to classify and probably contains several different HGM classes. For example, seeps at the base of a slope may grade into a riverine floodplain, or a small stream within a depressional wetland has a zone of flooding along its sides. **GO BACK AND IDENTIFY WHICH OF THE HYDROLOGIC REGIMES DESCRIBED IN QUESTIONS 1-7 APPLY TO DIFFERENT AREAS IN THE UNIT** (make a rough sketch to help you decide). Use the following table to identify the appropriate class to use for the rating system if you have several HGM classes present within your wetland. NOTE: Use this table only if the class that is recommended in the second column represents 10% or more of the total area of the wetland unit being rated. If the area of the class listed in column 2 is less than 10% of the unit, classify the wetland using the class that represents more than 90% of the total area.

HGM Classes within the wetland unit being rated	HGM Class to Use in Rating
Slope + Riverine	Riverine
Slope + Depressional	Depressional
Slope + Lake-fringe	Lake-fringe
Depressional + Riverine along stream within boundary	Depressional
Depressional + Lake-fringe	Depressional
Salt Water Tidal Fringe and any other class of freshwater wetland	Treat as ESTUARINE under wetlands with special characteristics

Exhibit 16  
SSDP2016-00415  
000990

If you are unable still to determine which of the above criteria apply to your wetland, or you have more than 2 HGM classes within a wetland boundary, classify the wetland as **Depressional** for the rating.

<b>D Depressional and Flat Wetlands</b>		<b>Points</b>
WATER QUALITY FUNCTIONS – Indicators that wetland functions to improve water quality.		(only 1 score per box) (see p.38)
<b>D 1</b>	<b>Does the wetland have the <u>potential</u> to improve water quality?</b>	
D 1.1	Characteristics of surface water flows out of the wetland: • Unit is a depression with no surface water leaving it (no outlet)..... points = 3 • <b>Unit has an intermittently flowing, OR highly constricted, permanently flowing outlet ..... points = 2</b> • Unit has an unconstricted, or slightly constricted, surface outlet ( <i>permanently flowing</i> ) ..... points = 1 • Unit is a “flat” depression (Q.7 on key), or in the Flats class, with permanent surface outflow <b>and no obvious natural outlet</b> and/or outlet is a man-made ditch..... points = 1 ( <i>If ditch is not permanently flowing treat unit as “intermittently flowing”</i> ) <b>Provide photo or drawing</b>	Figure ____  2
D 1.2	The soil 2 inches below the surface (or duff layer) is clay or organic ( <i>use NRCS definitions</i> ) YES points = 4 NO points = 0	
D 1.3	Characteristics of persistent vegetation (emergent, shrub, and/or forest Cowardin class): • Wetland has persistent, ungrazed vegetation > = 95% of area..... points = 5 • Wetland has persistent, ungrazed vegetation > = 1/2 of area..... points = 3 • Wetland has persistent, ungrazed vegetation > = 1/10 of area..... points = 1 • <b>Wetland has persistent, ungrazed vegetation &lt; 1/10 of area..... points = 0</b> <b>Map of Cowardin vegetation classes</b>	Figure ____  0
D 1.4	Characteristics of seasonal ponding or inundation: <i>This is the area of the wetland that is ponded for at least 2 months, but dries out sometime during the year. Do not count the area that is permanently ponded. Estimate area as the average condition 5 out of 10 years.</i> • Area seasonally ponded is > 1/2 total area of wetland ..... points = 4 • Area seasonally ponded is > 1/4 total area of wetland ..... points = 2 • <b>Area seasonally ponded is &lt; 1/4 total area of wetland ..... points = 0</b> <b>Map of Hydroperiods</b>	Figure ____  0
<b>Total for D 1</b>		<i>Add the points in the boxes above</i> <b>2</b>
<b>D 2</b>	<b>Does the wetland have the <u>opportunity</u> to improve water quality?</b>	(see p. 44)
Answer YES if you know or believe there are pollutants in groundwater or surface water coming into the wetland that would otherwise reduce water quality in streams, lakes or groundwater downgradient from the wetland? <i>Note which of the following conditions provide the sources of pollutants. A unit may have pollutants coming from several sources, but any single source would qualify as opportunity.</i> ___ Grazing in the wetland or within 150 ft ___ Untreated stormwater discharges to wetland ___ Tilled fields or orchards within 150 ft. of wetland ___ A stream or culvert discharges into wetland that drains developed areas, residential areas, farmed fields, roads, or clear-cut logging <u>X</u> Residential, urban areas, golf courses are within 150 ft. of wetland ___ Wetland is fed by groundwater high in phosphorus or nitrogen ___ Other _____ YES multiplier is 2 NO multiplier is 1		Multiplier  X2
<b>◆ TOTAL – Water Quality Functions</b> Multiply the score from D1 by D2; then <i>add score to table on p. 1</i>		<b>4</b>
HYDROLOGIC FUNCTIONS – Indicators that wetland unit functions to reduce flooding and stream degradation.		
<b>D 3</b>	<b>Does the wetland have the <u>potential</u> to reduce flooding and erosion?</b>	(see p.46)
D 3.1	Characteristics of surface water flows out of the wetland unit • Unit is a depression with no surface water leaving it (no outlet)..... points = 4 • <b>Unit has an intermittently flowing, OR highly constricted permanently flowing outlet ..... points = 2</b> • Unit is a “flat” depression (Q.7 on key) or in the Flats class, with permanent surface outflow <b>and no obvious natural outlet</b> and/or outlet is a man-made ditch..... points = 1 ( <i>If ditch is not permanently flowing treat unit as “intermittently flowing”</i> ) • Unit has an unconstricted, or slightly constricted, surface outlet ( <i>permanently flowing</i> ) ..... points = 0	2
D 3.2	Depth of storage during wet periods. <i>Estimate the height of ponding above the bottom of the outlet. For units with no outlet measure from the surface of permanent water or deepest part (if dry).</i> • Marks of ponding are 3 ft. or more above the surface or bottom of the outlet ..... points = 7 • The wetland is a “headwater” wetland..... points = 5 • Marks of ponding between 2 ft. to < 3 ft. from surface or bottom of outlet ..... points = 5 • Marks are at least 0.5 ft. to < 2 ft. from surface or bottom of outlet ..... points = 3 • Wetland is flat (yes to Q.2 or Q.7 on key)but has small depressions on the surface that trap water points = 1 • <b>Marks of ponding less than 0.5 ft ..... points = 0</b>	0
D 3.3	Contribution of wetland unit to storage in the watershed: <i>Estimate the ratio of the area of upstream basin contributing surface water to the wetland to the area of the wetland unit itself.</i> • <b>The area of the basin is less than 10 times the area of unit..... points = 5</b> • The area of the basin is 10 to 100 times the area of the unit ..... points = 3 • The area of the basin is more than 100 times the area of the unit ..... points = 0 • Entire unit is in the FLATS class ..... points = 5	5
<b>Total for D 3</b>		<i>Add the points in the boxes above</i> <b>7</b>

<p><b>D 4</b></p>	<p><b>Does the wetland have the <u>opportunity</u> to reduce flooding and erosion?</b></p> <p>Answer YES if the unit is in a location in the watershed where the flood storage, or reduction in water velocity, it provides helps protect downstream property and aquatic resources from flooding or excessive and/or erosive flows. Answer NO if the water coming into the wetland is controlled by a structure such as flood gate, tide gate, flap valve, reservoir etc. OR you estimate that more than 90% of the water in the wetland is from groundwater in areas where damaging groundwater flooding does not occur. <i>Note which of the following indicators of opportunity apply.</i></p> <p><input type="checkbox"/> Wetland is in a headwater of a river or stream that has flooding problems.  <input checked="" type="checkbox"/> Wetland drains to a river or stream that has flooding problems  <input type="checkbox"/> Wetland has no outlet and impounds surface runoff water that might otherwise flow into a river or stream that has flooding problems  <input type="checkbox"/> Other _____</p> <p>YES multiplier is 2    NO multiplier is 1</p>	<p>(see p. 49)</p> <p>Multiplier X2</p>
<p><b>◆</b></p>	<p><b>TOTAL – Hydrologic Functions</b>    Multiply the score from D3 by D4; then <i>add score to table on p. 1</i></p>	<p>14</p>

**Comments:**





These questions apply to wetlands of all HGM classes.		Points (only 1 score per box)
HABITAT FUNCTIONS – Indicators that wetland functions to provide important habitat.		
<b>H 1</b>	<b>Does the wetland have the <u>potential</u> to provide habitat for many species?</b>	
H 1.1	<p><u>Vegetation structure</u> (see P. 72): Check the types of vegetation classes present (as defined by Cowardin) – Size threshold for each class is 1/4 acre or more than 10% of the area if unit is smaller than 2.5 acres.</p> <p><input checked="" type="checkbox"/> Aquatic Bed  <input checked="" type="checkbox"/> Emergent plants  <input type="checkbox"/> Scrub/shrub (areas where shrubs have &gt; 30% cover)  <input type="checkbox"/> Forested (areas where trees have &gt; 30% cover)</p> <p>If the unit has a forested class check if:  <input type="checkbox"/> The forested class has 3 out of 5 strata (canopy, sub-canopy, shrubs, herbaceous, moss/ground-cover) that each cover 20% within the forested polygon.            Add the number of vegetation types that qualify. If you have:</p> <p style="text-align: right;"><b>Map of Cowardin vegetation classes</b></p> <p style="text-align: right;">4 structures or more..... points = 4            3 structures ..... points = 2            1 structure ..... points = 0</p>	Figure ____  0
H 1.2	<p><u>Hydroperiods</u> (see p.73): Check the types of water regimes (hydroperiods) present within the wetland. The water regime has to cover more than 10% of the wetland or 1/4 acre to count (see text for descriptions of hydroperiods).</p> <p><input checked="" type="checkbox"/> Permanently flooded or inundated  <input type="checkbox"/> Seasonally flooded or inundated  <input type="checkbox"/> Occasionally flooded or inundated  <input checked="" type="checkbox"/> Saturated only  <input type="checkbox"/> Permanently flowing stream or river in, or adjacent to, the wetland  <input type="checkbox"/> Seasonally flowing stream in, or adjacent to, the wetland  <input type="checkbox"/> Lake-fringe wetland..... = 2 points  <input type="checkbox"/> Freshwater tidal wetland..... = 2 points</p> <p style="text-align: right;"><b>Map of hydroperiods</b></p> <p style="text-align: right;">4 or more types present points = 3            3 or more types present..... points = 2            2 types present ..... points = 1            1 type present ..... points = 0</p>	Figure ____  1
H 1.3	<p><u>Richness of Plant Species</u> (see p. 75): Count the number of plant species in the wetland that cover at least 10 ft<sup>2</sup> (different patches of the same species can be combined to meet the size threshold) You do not have to name the species. Do not include Eurasian Milfoil, reed canarygrass, purple loosestrife, Canadian Thistle.</p> <p>If you counted: &gt; 19 species ..... points = 2            5 – 19 species..... points = 1            &lt; 5 species ..... points = 0</p> <p>List species below if you want to:            _____            _____            _____</p>	Figure ____  1
H 1.4	<p><u>Interspersion of Habitats</u> (see p. 76): Decided from the diagrams below whether interspersion between Cowardin vegetation (described in H1.1), or the classes and unvegetated areas (can include open water or mudflats) is high, medium, low, or <b>none</b>.</p> <div style="display: flex; justify-content: space-around;"> <div style="text-align: center;">  <p>None = 0 points</p> </div> <div style="text-align: center;">  <p>Low = 1 point</p> </div> <div style="text-align: center;">  <p>Moderate = 2 points</p> </div> <div style="text-align: center;">  <p>High = 3 points</p> </div> </div> <p style="text-align: center;">[riparian braided channels]</p> <p>Note: If you have 4 or more classes or 3 vegetation classes and open water, the rating is always “high”.</p> <p style="text-align: center;"><b>Use map of Cowardin classes.</b></p>	Figure ____  0
H 1.5	<p><u>Special Habitat Features</u> (see p. 77): Check the habitat features that are present in the wetland. The number of checks is the number of points you put into the next column.</p> <p><input type="checkbox"/> Large, downed, woody debris within the wetland (&gt; 4 in. diameter and 6 ft. long)  <input type="checkbox"/> Standing snags (diameter at the bottom &gt; 4 inches) in the wetland  <input type="checkbox"/> Undercut banks are present for at least 6.6 ft. (2m) and/or overhanging vegetation extends at least 3.3 ft. (1m) over a stream (or ditch) in, or contiguous with the unit, for at least 33 ft. (10m)  <input type="checkbox"/> Stable steep banks of fine material that might be used by beaver or muskrat for denning (&gt; 30 degree slope) OR signs of recent beaver activity are present (cut shrubs or trees that have not yet turned grey/brown)  <input type="checkbox"/> At least 1/4 acre of thin-stemmed persistent vegetation or woody branches are present in areas that are permanently or seasonally inundated (structures for egg-laying by amphibians)  <input type="checkbox"/> Invasive plants cover less than 25% of the wetland area in each stratum of plants</p> <p>NOTE: The 20% stated in early printings of the manual on page 78 is an error.</p>	Figure ____  0
<b>H 1 TOTAL Score</b> – potential for providing habitat		2

Exhibit 16  
 S51P2016-00215  
 000993

<b>H 2</b>	<b>Does the wetland have the opportunity to provide habitat for many species?</b>	(only 1 score per box)
	<p>H 2.1 <b>Buffers</b> (see P. 80): <i>Choose the description that best represents condition of buffer of wetland unit. The highest scoring criterion that applies to the wetland is to be used in the rating. See text for definition of "undisturbed".</i></p> <p><input type="checkbox"/> 100m (330 ft) of relatively undisturbed vegetated areas, rocky areas, or open water &gt; 95% of circumference. No structures are within the undisturbed part of buffer (relatively undisturbed also means no grazing, no landscaping, no daily human use)..... <b>points = 5</b></p> <p><input type="checkbox"/> 100m (330 ft) of relatively undisturbed vegetated areas, rocky areas, or open water &gt; 50% circumference ..... <b>points = 4</b></p> <p><input type="checkbox"/> 50m (170 ft) of relatively undisturbed vegetated areas, rocky areas, or open water &gt; 95% circumference ..... <b>points = 4</b></p> <p><input type="checkbox"/> 100m (330 ft) of relatively undisturbed vegetated areas, rocky areas, or open water &gt; 25% circumference ..... <b>points = 3</b></p> <p><input type="checkbox"/> 50m (170 ft) of relatively undisturbed vegetated areas, rocky areas, or open water for &gt; 50% circumference ..... <b>points = 3</b></p> <p><b>If buffer does not meet any of the criteria above:</b></p> <p><input type="checkbox"/> No paved areas (except paved trails) or buildings within 25m (80 ft) of wetland &gt; 95% circumference. Light to moderate grazing or lawns are OK ..... <b>points = 2</b></p> <p><input type="checkbox"/> No paved areas of buildings within 50m of wetland for &gt; 50% circumference. Light to moderate grazing or lawns are OK..... <b>points = 2</b></p> <p><input type="checkbox"/> Heavy grazing in buffer ..... <b>points = 1</b></p> <p><input type="checkbox"/> Vegetated buffers are &lt; 2m wide (6.6 ft) for more than 95% circumference (e.g. tilled fields, paving, basalt bedrock extend to edge of wetland) ..... <b>points = 0</b></p> <p><input checked="" type="checkbox"/> Buffer does not meet any of the criteria above ..... <b>points = 1</b></p> <p style="text-align: right;"><b>Arial photo showing buffers</b></p>	<b>Figure</b> ____  1
	<p>H 2.2 <b>Corridors and Connections</b> (see p. 81)</p> <p>H 2.2.1 Is the wetland part of a relatively undisturbed and unbroken vegetated corridor (either riparian or upland) that is at least 150 ft. wide, has at least a 30% cover of shrubs, forest or native undisturbed prairie, that connects to estuaries, other wetlands or undisturbed uplands that are at least 250 acres in size? (<i>Dams in riparian corridors, heavily used gravel roads, paved roads, are considered breaks in the corridor.</i>) YES = <b>4 points</b> (go to H 2.3)                                  <b>NO = go to H 2.2.2</b></p> <p>H. 2.2.2 Is the wetland part of a relatively undisturbed and unbroken vegetated corridor (either riparian or upland) that is at least 50 ft. wide, has at least 30% cover of shrubs or forest, and connects to estuaries, other wetlands or undisturbed uplands that are at least 25 acres in size? <b>OR a Lake-fringe</b> wetland, if it does not have an undisturbed corridor as in the question above? YES = <b>2 points</b> (go to H 2.3)                                  <b>NO = go to H 2.2.3</b></p> <p>H. 2.2.3 Is the wetland: <ul style="list-style-type: none"><li>• Within 5 mi (8km) of a brackish or salt water estuary OR</li><li>• Within 3 miles of a large field or pasture (&gt; 40 acres) OR                                  <b>YES = 1 point</b></li><li>• <b>Within 1 mile of a lake greater than 20 acres?</b>                                  <b>NO = 0 points</b></li></ul></p>	1

Comments:

**Exhibit 16  
SSDP2016-00415  
000994**

	<p>H 2.3 <u>Near or adjacent to other priority habitats listed by WDFW</u> (see p. 82): (see new and complete descriptions of WDFW priority habitats, and the counties in which they can be found, in the PHS report <a href="http://wdfw.wa.gov/hab/phslist.htm">http://wdfw.wa.gov/hab/phslist.htm</a> )</p> <p>Which of the following priority habitats are within 330 ft. (100m) of the wetland unit?  <i>NOTE: the connections do not have to be relatively undisturbed.</i></p> <p><input type="checkbox"/> <b>Aspen Stands:</b> Pure or mixed stands of aspen greater than 0.4 ha (1 acre).</p> <p><input type="checkbox"/> <b>Biodiversity Areas and Corridors:</b> Areas of habitat that are relatively important to various species of native fish and wildlife (full descriptions in WDFW PHS report p. 152).</p> <p><input type="checkbox"/> <b>Herbaceous Balds:</b> Variable size patches of grass and forbs on shallow soils over bedrock.</p> <p><input type="checkbox"/> <b>Old-growth/Mature forests:</b> (Old-growth west of Cascade crest) Stands of at least 2 tree species, forming a multi-layered canopy with occasional small openings; with at least 20 trees/ha (8 trees/acre) &gt; 81 cm (32 in) dbh or &gt; 200 years of age. (Mature forests) Stands with average diameters exceeding 53 cm (21 in) dbh; crown cover may be less than 100%; decay, decadence, numbers of snags, and quantity of large downed material is generally less than that found in old-growth; 80 - 200 years old west of the Cascade crest.</p> <p><input type="checkbox"/> <b>Oregon white Oak:</b> Woodlands Stands of pure oak or oak/conifer associations where canopy coverage of the oak component is important (full descriptions in WDFW PHS report p. 158).</p> <p><input checked="" type="checkbox"/> <b>Riparian:</b> The area adjacent to aquatic systems with flowing water that contains elements of both aquatic and terrestrial ecosystems which mutually influence each other.</p> <p><input type="checkbox"/> <b>Westside Prairies:</b> Herbaceous, non-forested plant communities that can either take the form of a dry prairie or a wet prairie (full descriptions in WDFW PHS report p. 161).</p> <p><input checked="" type="checkbox"/> <b>Instream:</b> The combination of physical, biological, and chemical processes and conditions that interact to provide functional life history requirements for instream fish and wildlife resources.</p> <p><input type="checkbox"/> <b>Nearshore:</b> Relatively undisturbed nearshore habitats. These include Coastal Nearshore, Open Coast Nearshore, and Puget Sound Nearshore. (full descriptions of habitats and the definition of relatively undisturbed are in WDFW report: pp. 167-169 and glossary in Appendix A).</p> <p><input type="checkbox"/> <b>Caves:</b> A naturally occurring cavity, recess, void, or system of interconnected passages under the earth in soils, rock, ice, or other geological formations and is large enough to contain a human.</p> <p><input type="checkbox"/> <b>Cliffs:</b> Greater than 7.6 m (25 ft) high and occurring below 5000 ft.</p> <p><input type="checkbox"/> <b>Talus:</b> Homogenous areas of rock rubble ranging in average size 0.15 - 2.0 m (0.5 - 6.5 ft), composed of basalt, andesite, and/or sedimentary rock, including riprap slides and mine tailings. May be associated with cliffs.</p> <p><input type="checkbox"/> <b>Snags and Logs:</b> Trees are considered snags if they are dead or dying and exhibit sufficient decay characteristics to enable cavity excavation/use by wildlife. Priority snags have a diameter at breast height of &gt; 51 cm (20 in) in western Washington and are &gt; 2 m (6.5 ft) in height. Priority logs are &gt; 30 cm (12 in) in diameter at the largest end, and &gt; 6 m (20 ft) long.</p> <p>If wetland has <b>3 or more</b> priority habitats = <b>4 points</b>  <b>If wetland has 2</b> priority habitats = <b>3 points</b>                  If wetland has <b>1</b> priority habitat = <b>1 point</b>                      No habitats = 0 points</p> <p>Note: All vegetated wetlands are by definition a priority habitat but are not included in this list. Nearby wetlands are addressed in question H 2.4)</p>	3
	<p>H 2.4 <u>Wetland Landscape:</u> Choose the <b>one</b> description of the landscape around the wetland that best fits (see p. 84)</p> <ul style="list-style-type: none"> <li>• There are at least 3 other wetlands within 1/2 mile, and the connections between them are relatively undisturbed (light grazing between wetlands OK, as is lake shore with some boating, but connections should NOT be bisected by paved roads, fill, fields, or other development.....points = 5</li> <li>• The wetland is Lake-fringe on a lake with little disturbance and there are 3 other lake-fringe wetlands within 1/2 mile .....points = 5</li> <li>• <b>There are at least 3 other wetlands within 1/2 mile, BUT the connections between them are disturbed.....points = 3</b></li> <li>• The wetland fringe on a lake <b>with</b> disturbance and there are 3 other lake-fringe wetlands within 1/2 mile .....points = 3</li> <li>• There is at least 1 wetland within 1/2 mile .....points = 2</li> <li>• There are no wetlands within 1/2 mile.....points = 0</li> </ul>	3
<p><b>H 2 TOTAL Score</b> – opportunity for providing habitat                      Add the scores from H2.1, H2.2, H2.3, H2.4</p>		8
<p style="text-align: right;"><i>TOTAL for H 1 from page 8</i></p>		2
◆	<p><b>Total Score for Habitat Functions</b>                      Add the points for H 1 and H 2; then <b>record the result on p. 1</b></p>	10

Comments:



### CATEGORIZATION BASED ON SPECIAL CHARACTERISTICS

*Please determine if the wetland meets the attributes described below  
and circle the appropriate answers and Category.*

<b>Wetland Type</b> – Check off any criteria that apply to the wetland. Circle the Category when the appropriate criteria are met.	
<b>SC1</b>	<p><b>Estuarine wetlands?</b> (see p.86)</p> <p>Does the wetland unit meet the following criteria for Estuarine wetlands?</p> <p><input type="checkbox"/> The dominant water regime is tidal,</p> <p><input type="checkbox"/> Vegetated, and</p> <p><input type="checkbox"/> With a salinity greater than 0.5 ppt.</p> <p style="text-align: center;">YES = Go to SC 1.1                      NO = <u>X</u></p>
	<p>SC 1.1 Is the wetland unit within a National Wildlife Refuge, National Park, National Estuary Reserve, Natural Area Preserve, State Park or Educational, Environmental, or Scientific Reserve designated under WAC 332-30-151?    YES = Category I                      NO = go to SC 1.2</p>
	<p>SC 1.2 Is the wetland at least 1 acre in size and meets at least two of the following conditions?</p> <p style="text-align: center;">YES = Category I                      NO = Category II</p> <p><input type="checkbox"/> The wetland is relatively undisturbed (has no diking, ditching, filling, cultivation, grazing, and has less than 10% cover of non-native plant species. If the non-native <i>Spartina</i> spp., are only species that cover more than 10% of the wetland, then the wetland should be given a dual rating (I/II). The area of <i>Spartina</i> would be rated a Category II while the relatively undisturbed upper marsh with native species would be a Category I. Do not, however, exclude the area of <i>Spartina</i> in determining the size threshold of 1 acre.</p> <p><input type="checkbox"/> At least 3/4 of the landward edge of the wetland has a 100 ft. buffer of shrub, forest, or un-grazed or un-mowed grassland</p> <p><input type="checkbox"/> The wetland has at least 2 of the following features: tidal channels, depressions with open water, or contiguous freshwater wetlands.</p>
	<p><b>Cat. I</b></p> <p><b>Cat. I</b></p> <p><b>Dual Rating I/II</b></p>
<b>SC2</b>	<p><b>Natural Heritage Wetlands</b> (see p. 87)</p> <p>Natural Heritage wetlands have been identified by the Washington Natural Heritage Program/DNR as either high quality undisturbed wetlands or wetlands that support state Threatened, Endangered, or Sensitive plant species.</p> <p>SC 2.1 Is the wetland being rated in a Section/Township/Range that contains a natural heritage wetland? (<i>This question is used to screen out most sites before you need to contact WNHP/DNR.</i>)</p> <p style="text-align: center;">S/T/R information from Appendix D _____ or accessed from WNHP/DNR web site _____</p> <p style="text-align: center;">YES _____ Contact WNHP/DNR (see p. 79) and go to SC 2.2                      NO = <u>X</u></p> <p>SC 2.2 Has DNR identified the wetland as a high quality undisturbed wetland or as a site with state threatened or endangered plant species?</p> <p style="text-align: center;">YES = Category 1                      NO _____ not a Heritage Wetland</p>
	<p><b>Cat I</b></p>
<b>SC3</b>	<p><b>Bogs</b> (see p. 87)</p> <p>Does the wetland (<b>or any part of the unit</b>) meet both the criteria for soils and vegetation in bogs? Use the key below to identify if the wetland is a bog. <i>If you answer yes you will still need to rate the wetland based on its function.</i></p> <ol style="list-style-type: none"> <li>1. Does the unit have organic soil horizons (i.e. layers of organic soil), either peats or mucks, that compose 16 inches or more of the first 32 inches of soil profile? (See Appendix B for a field key to identify organic soils)?    YES = go to question 3                      <b>NO = go to question 2</b></li> <li>2. Does the wetland have organic soils, either peats or mucks that are less than 16 inches deep over bedrock, or an impermeable hardpan such as clay or volcanic ash, or that are floating on a lake or pond?    YES = go to question 3                      <b>NO = is not a bog for purpose of rating</b></li> <li>3. Does the unit have more than 70% cover of mosses at ground level, AND other plants, if present, consist of the “bog” species listed in Table 3 as a significant component of the vegetation (more than 30% of the total shrub and herbaceous cover consists of species in Table 3)?</li> </ol> <p style="text-align: center;">YES = Is a bog for purpose of rating                      NO = go to question 4</p> <p>NOTE: If you are uncertain about the extent of mosses in the understory you may substitute that criterion by measuring the pH of the water that seeps into a hole dug at least 16” deep. If the pH is less than 5.0 and the “bog” plant species in Table 3 are present, the wetland is a bog.</p> <ol style="list-style-type: none"> <li>4. Is the unit forested (&gt; 30% cover) with sitka spruce, subalpine fir, western red cedar, western hemlock, lodgepole pine, quaking aspen, Englemann’s spruce, or western white pine. WITH any of the species (or combination of species) on the bog species plant list in Table 3 as a significant component of the ground cover (&gt; 30% coverage of the total shrub/herbaceous cover)?</li> </ol> <p style="text-align: center;">YES = Category I                      NO = Is not a bog for purpose of rating</p>
	<p><b>Cat. I</b></p>

**Exhibit 16**  
**SSDP2016-00415**  
**000996**

<p><b>SC4</b></p>	<p><b>Forested Wetlands</b> (see p. 90)                  Does the wetland have at least 1 acre of forest that meet one of these criteria for the Department of Fish and Wildlife's forests as priority habitats? <i>If you answer yes you will still need to rate the wetland based on its function.</i></p> <p>___ <b>Old-growth forests:</b> (west of Cascade Crest) Stands of at least two three species forming a multi-layered canopy with occasional small openings; with at least 8 trees/acre (20 trees/hectare) that are at least 200 years of age OR have a diameter at breast height (dbh) of 32 inches (81 cm or more).</p> <p>NOTE: The criterion for dbh is based on measurements for upland forests. Two-hundred year old trees in wetlands will often have a smaller dbh because their growth rates are often slower. The DFW criterion is and "OR" so old-growth forests do not necessarily have to have trees of this diameter.</p> <p>___ <b>Mature forests:</b> (west of the Cascade Crest) Stands where the largest trees are 80 – 200 years old OR have an average diameters (dbh) exceeding 21 inches (53 cm); crown cover may be less than 100%; decay, decadence, numbers of snags, and quantity of large downed material is generally less than that found in old-growth.</p> <p>YES = Category I                      NO = <u>X</u> not a forested wetland with special characteristics</p>	<p><b>Cat. I</b></p>
<p><b>SC5</b></p>	<p><b>Wetlands in Coastal Lagoons</b> (see p. 91)                  Does the wetland meet all of the following criteria of a wetland in a coastal lagoon?</p> <p>___ The wetland lies in a depression adjacent to marine waters that is wholly or partially separated from marine waters by sandbanks, gravel banks, shingle, or, less frequently, rocks.</p> <p>___ The lagoon in which the wetland is located contains surface water that is saline or brackish (&gt; 0.5 ppt) during most of the year in at least a portion of the lagoon (<i>needs to be measured near the bottom.</i>)</p> <p>YES = Go to SC 5.1                      NO <u>X</u> not a wetland in a coastal lagoon</p> <p>SC 5.1 Does the wetland meet all of the following three conditions?</p> <p>___ The wetland is relatively undisturbed (has no diking, ditching, filling, cultivation, grazing) and has less than 20% cover of invasive plant species (see list of invasive species on p. 74).</p> <p>___ At least 3/4 of the landward edge of the wetland has a 100 ft. buffer of shrub, forest, or un-grazed or un-mowed grassland.</p> <p>___ The wetland is larger than 1/10 acre (4350 square ft.)</p> <p>YES = Category I                      NO = Category II</p>	<p><b>Cat. I</b></p> <p><b>Cat. II</b></p>
<p><b>SC6</b></p>	<p><b>Interdunal Wetlands</b> (see p. 93)                  Is the wetland west of the 1889 line (also called the Western Boundary of Upland Ownership or WBUO)?</p> <p>YES = Go to SC 6.1                      NO <u>X</u> not an interdunal wetland for rating</p> <p><b><i>If you answer yes you will still need to rate the wetland based on its functions.</i></b></p> <p>In practical terms that means the following geographic areas:</p> <ul style="list-style-type: none"> <li>• Long Beach Peninsula -- lands west of SR 103</li> <li>• Grayland-Westport -- lands west of SR 105</li> <li>• Ocean Shores-Copalis – lands west of SR 115 and SR 109</li> </ul> <p>SC 6.1 Is the wetland one acre or larger, or is it in a mosaic of wetlands that is one acre or larger?</p> <p>YES = Category II                      NO = go to SC 6.2</p> <p>SC 6.2 Is the wetland between 0.1 and 1 acre, or is it in a mosaic of wetlands that is between 0.1 and 1 acre?</p> <p>YES = Category III</p>	<p><b>Cat. II</b></p> <p><b>Cat. III</b></p>
<p>◆</p>	<p><b>Category of wetland based on Special Characteristics</b>                  Choose the "highest" rating if wetland falls into several categories, and record on p. 1.                  If you answered NO for all types enter "Not Applicable" on p. 1</p>	<p><b>NA</b></p>

**Comments:**

Wetland name or number 18C

**WETLAND RATING FORM – WESTERN WASHINGTON**  
Version 2 – Updated July 2006 to increase accuracy and reproducibility among users  
Updated Oct. 2008 with the new WDFW definitions for priority habitats

Name of wetland (if known): 18C Date of site visit: 03-11-14

Rated by: Colin Worsley / Matt Maynard Trained by Ecology? Yes X No      Date of training: 11-2005 / 04-2006

SEC: 06 TOWNSHIP: 24N RANGE: 06E Is S/T/R in Appendix D? Yes      No X

Map of wetland unit: Figure                      Estimated size 0.02 acre

**SUMMARY OF RATING**

Category based on FUNCTIONS provided by wetland: I      II      III X IV     

Category I =	Score > 70
Category II =	Score 51 - 69
Category III =	Score 30 – 50
Category IV =	Score < 30

Score for Water Quality Functions	24
Score for Hydrologic Functions	14
Score for Habitat Functions	8
<b>TOTAL Score for Functions</b>	<b>46</b>

Category based on SPECIAL CHARACTERISTICS of Wetland I      II      Does not apply X

**Final Category** (choose the “highest” category from above”) **III**

**Summary of basic information about the wetland unit.**

Wetland Unit has Special Characteristics		Wetland HGM Class used for Rating	
<b>Estuarine</b>		<b>Depressional</b>	<b>X</b>
<b>Natural Heritage Wetland</b>		<b>Riverine</b>	
<b>Bog</b>		<b>Lake-fringe</b>	
<b>Mature Forest</b>		<b>Slope</b>	
<b>Old Growth Forest</b>		<b>Flats</b>	
<b>Coastal Lagoon</b>		<b>Freshwater Tidal</b>	
<b>Interdunal</b>			
None of the above	X	Check if unit has multiple HGM classes present	<span style="border: 1px solid black; padding: 2px;">    </span>

**Does the wetland being rated meet any of the criteria below?** If you answer YES to any of the questions below you will need to protect the wetland according to the regulations regarding the special characteristics found in the wetland.

Check List for Wetlands that Need Additional Protection (in addition to the protection recommended for its category)	YES	NO
SP1. <i>Has the wetland unit been documented as a habitat for any Federally listed Threatened or Endangered <b>animal or plant</b> species (T/E species)?</i> For the purposes of this rating system, “documented” means the wetland is on the appropriate state or federal database.		X
SP2. <i>Has the wetland unit been documented as habitat for any State listed Threatened or Endangered <b>animal</b> species?</i> For the purposes of this rating system, “documented” means the wetland is on the appropriate state database. Note: Wetlands with State listed plant species are categorized as Category 1 Natural Heritage Wetlands (see p. 19 of data form).		X
SP3. <i>Does the wetland unit contain individuals of Priority species listed by the WDFW for the state?</i>		X
SP4. <i>Does the wetland unit have a local significance in addition to its functions?</i> For example, the wetland has been identified in the Shoreline Master Program, the Critical Areas Ordinance, or in a local management plan as having special significance.		X

To complete the next part of the data sheet you will need to determine the Hydrogeomorphic Class of the wetland being rated.

Exhibit 16  
SSDP2016-00415  
000998

### Classification of Vegetated Wetlands for Western Washington

If the hydrologic criteria listed in each question do not apply to the entire unit being rated, you probably have a unit with multiple HGM classes. In this case, identify which hydrologic criteria in questions 1-7 apply, and go to Question 8.

1. Are the water levels in the entire unit usually controlled by tides (i.e. except during floods)?  
NO – go to 2                      **YES – the wetland class is Tidal Fringe**  
 If yes, is the salinity of the water during periods of annual low flow below 0.5 ppt (parts per thousand)?  
**YES – Freshwater Tidal Fringe**                      **NO – Saltwater Tidal Fringe (Estuarine)**  
*If your wetland can be classified as a Freshwater Tidal Fringe use the forms for Riverine wetlands. If it is a Saltwater Tidal Fringe it is rated as an Estuarine wetland. Wetlands that were call estuarine in the first and second editions of the rating system are called Salt Water Tidal Fringe in the Hydrogeomorphic Classification. Estuarine wetlands were categorized separately in the earlier editions, and this separation is being kept in this revision. To maintain consistency between editions, the term “Estuarine” wetland is kept. Please note, however, that the characteristics that define Category I and II estuarine wetlands have changed (see p. \_\_\_\_).*

---

2. The entire wetland unit is flat and precipitation is only source (>90%) of water to it. Groundwater and surface water runoff are NOT sources of water to the unit.  
NO – go to 3                      **YES – The wetland class is Flats**  
 If your wetland can be classified as a “Flats” wetland, use the form for **Depressional** wetlands.

---

3. Does the entire wetland meet both of the following criteria?  
 \_\_\_\_\_ The vegetated part of the wetland is on the shores of a body of permanent open water (without any vegetation on the surface) where at least 20 acres (8ha) in size;  
 \_\_\_\_\_ At least 30% of the open water area is deeper than 6.6 (2 m)?  
NO – go to 4                      **YES – The wetland class is Lake-fringe (Lacustrine Fringe)**

---

4. Does the entire wetland meet all of the following criteria?  
 \_\_\_\_\_ The wetland is on a slope (*slope can be very gradual*).  
 \_\_\_\_\_ The water flows through the wetland in one direction (unidirectional) and usually comes from seeps. It may flow subsurface, as sheetflow, or in a swale without distinct banks.  
 \_\_\_\_\_ The water leaves the wetland **without being impounded**?  
 NOTE: *Surface water does not pond in these types of wetlands except occasionally in very small and shallow depressions or behind hummocks (depressions are usually <3 ft diameter and less than 1 foot deep).*  
NO – go to 5                      **YES – The wetland class is Slope**

---

5. Does the entire wetland meet all of the following criteria?  
 \_\_\_\_\_ The unit is in a valley or stream channel where it gets inundated by overbank flooding from that stream or river.  
 \_\_\_\_\_ The overbank flooding occurs at least once every two years.  
 NOTE: *The riverine unit can contain depressions that are filled with water when the river is not flooding..*  
NO – go to 6                      **YES – The wetland class is Riverine**

---

6. Is the entire wetland unit in a topographic depression in which water ponds, or is saturated to the surface, at some time of the year. This means that any outlet, if present is higher than the interior of the wetland.  
NO – go to 7                      **YES – The wetland class is Depressional**

---

7. Is the entire wetland located in a very flat area with no obvious depression and no overbank flooding. The unit does not pond surface water more than a few inches. The unit seems to be maintained by high groundwater in the area. The wetland may be ditched, but has no obvious natural outlet.  
No – go to 8                      **YES – The wetland class is Depressional**

---

8. Your wetland unit seems to be difficult to classify and probably contains several different HGM classes. For example, seeps at the base of a slope may grade into a riverine floodplain, or a small stream within a depressional wetland has a zone of flooding along its sides. **GO BACK AND IDENTIFY WHICH OF THE HYDROLOGIC REGIMES DESCRIBED IN QUESTIONS 1-7 APPLY TO DIFFERENT AREAS IN THE UNIT** (make a rough sketch to help you decide). Use the following table to identify the appropriate class to use for the rating system if you have several HGM classes present within your wetland. NOTE: Use this table only if the class that is recommended in the second column represents 10% or more of the total area of the wetland unit being rated. If the area of the class listed in column 2 is less than 10% of the unit, classify the wetland using the class that represents more than 90% of the total area.

HGM Classes within the wetland unit being rated	HGM Class to Use in Rating
Slope + Riverine	Riverine
Slope + Depressional	Depressional
Slope + Lake-fringe	Lake-fringe
Depressional + Riverine along stream within boundary	Depressional
Depressional + Lake-fringe	Depressional
Salt Water Tidal Fringe and any other class of freshwater wetland	Treat as ESTUARINE under wetlands with special characteristics

**Exhibit 16**  
**SSDP2016-00415**  
**000999**



If you are unable still to determine which of the above criteria apply to your wetland, or you have more than 2 HGM classes within a wetland boundary, classify the wetland as **Depressional** for the rating.

<b>D Depressional and Flat Wetlands</b>		<b>Points</b>
WATER QUALITY FUNCTIONS – Indicators that wetland functions to improve water quality.		(only 1 score per box) (see p.38)
<b>D 1</b>	<b>Does the wetland have the <u>potential</u> to improve water quality?</b>	
	D 1.1 Characteristics of surface water flows out of the wetland: <ul style="list-style-type: none"> <li>• Unit is a depression with no surface water leaving it (no outlet) ..... points = 3</li> <li>• Unit has an intermittently flowing, OR highly constricted, permanently flowing outlet ..... points = 2</li> <li>• Unit has an unconstricted, or slightly constricted, surface outlet (<i>permanently flowing</i>) ..... points = 1</li> <li>• Unit is a “flat” depression (Q.7 on key), or in the Flats class, with permanent surface outflow <b>and no obvious natural outlet</b> and/or outlet is a man-made ditch..... points = 1 (If ditch is not permanently flowing treat unit as “intermittently flowing”) <b>Provide photo or drawing</b></li> </ul>	<b>Figure</b> ____  3
	D 1.2 The soil 2 inches below the surface (or duff layer) is clay or organic ( <i>use NRCS definitions</i> ) YES points = 4 NO points = 0	0
	D 1.3 Characteristics of persistent vegetation (emergent, shrub, and/or forest Cowardin class): <ul style="list-style-type: none"> <li>• Wetland has persistent, ungrazed vegetation &gt; = 95% of area..... points = 5</li> <li>• Wetland has persistent, ungrazed vegetation &gt; = 1/2 of area..... points = 3</li> <li>• Wetland has persistent, ungrazed vegetation &gt; = 1/10 of area..... points = 1</li> <li>• Wetland has persistent, ungrazed vegetation &lt; 1/10 of area..... points = 0</li> </ul> <b>Map of Cowardin vegetation classes</b>	<b>Figure</b> ____  5
	D 1.4 Characteristics of seasonal ponding or inundation: <i>This is the area of the wetland that is ponded for at least 2 months, but dries out sometime during the year. Do not count the area that is permanently ponded. Estimate area as the average condition 5 out of 10 years.</i> <ul style="list-style-type: none"> <li>• Area seasonally ponded is &gt; 1/2 total area of wetland ..... points = 4</li> <li>• Area seasonally ponded is &gt; 1/4 total area of wetland ..... points = 2</li> <li>• Area seasonally ponded is &lt; 1/4 total area of wetland ..... points = 0</li> </ul> <b>Map of Hydroperiods</b>	<b>Figure</b> ____  4
<b>Total for D 1</b>		<i>Add the points in the boxes above</i> 12
<b>D 2</b>	<b>Does the wetland have the <u>opportunity</u> to improve water quality?</b> Answer YES if you know or believe there are pollutants in groundwater or surface water coming into the wetland that would otherwise reduce water quality in streams, lakes or groundwater downgradient from the wetland? <i>Note which of the following conditions provide the sources of pollutants. A unit may have pollutants coming from several sources, but any single source would qualify as opportunity.</i> <input type="checkbox"/> Grazing in the wetland or within 150 ft <input type="checkbox"/> Untreated stormwater discharges to wetland <input type="checkbox"/> Tilled fields or orchards within 150 ft. of wetland <input type="checkbox"/> A stream or culvert discharges into wetland that drains developed areas, residential areas, farmed fields, roads, or clear-cut logging <input checked="" type="checkbox"/> Residential, urban areas, golf courses are within 150 ft. of wetland <input type="checkbox"/> Wetland is fed by groundwater high in phosphorus or nitrogen <input type="checkbox"/> Other _____ <b>YES multiplier is 2</b> NO multiplier is 1	(see p. 44)          Multiplier  X2
<b>♦ TOTAL – Water Quality Functions</b> Multiply the score from D1 by D2; then <b>add score to table on p. 1</b>		24
HYDROLOGIC FUNCTIONS – Indicators that wetland unit functions to reduce flooding and stream degradation.		
<b>D 3</b>	<b>Does the wetland have the <u>potential</u> to reduce flooding and erosion?</b>	(see p.46)
	D 3.1 Characteristics of surface water flows out of the wetland unit <ul style="list-style-type: none"> <li>• Unit is a depression with no surface water leaving it (no outlet)..... points = 4</li> <li>• Unit has an intermittently flowing, OR highly constricted permanently flowing outlet ..... points = 2</li> <li>• Unit is a “flat” depression (Q.7 on key) or in the Flats class, with permanent surface outflow <b>and no obvious natural outlet</b> and/or outlet is a man-made ditch..... points = 1 (If ditch is not permanently flowing treat unit as “intermittently flowing”)</li> <li>• Unit has an unconstricted, or slightly constricted, surface outlet (<i>permanently flowing</i>) ..... points = 0</li> </ul>	4
	D 3.2 Depth of storage during wet periods. <i>Estimate the height of ponding above the bottom of the outlet. For units with no outlet measure from the surface of permanent water or deepest part (if dry).</i> <ul style="list-style-type: none"> <li>• Marks of ponding are 3 ft. or more above the surface or bottom of the outlet ..... points = 7</li> <li>• The wetland is a “headwater” wetland..... points = 5</li> <li>• Marks of ponding between 2 ft. to &lt; 3 ft. from surface or bottom of outlet ..... points = 5</li> <li>• Marks are at least 0.5 ft. to &lt; 2 ft. from surface or bottom of outlet..... points = 3</li> <li>• Wetland is flat (yes to Q.2 or Q.7 on key)but has small depressions on the surface that trap water points = 1</li> <li>• Marks of ponding less than 0.5 ft..... points = 0</li> </ul>	3
	D 3.3 Contribution of wetland unit to storage in the watershed: <i>Estimate the ratio of the area of upstream basin contributing surface water to the wetland to the area of the wetland unit itself.</i> <ul style="list-style-type: none"> <li>• The area of the basin is less than 10 times the area of unit..... points = 5</li> <li>• The area of the basin is 10 to 100 times the area of the unit ..... points = 3</li> <li>• The area of the basin is more than 100 times the area of the unit..... points = 0</li> <li>• Entire unit is in the FLATS class ..... points = 5</li> </ul>	0
<b>Total for D 3</b>		<i>Add the points in the boxes above</i> 7

**Exhibit 16**  
**SSDP2016-00415**  
**001000**

<b>D 4</b>	<p><b>Does the wetland have the <u>opportunity</u> to reduce flooding and erosion?</b></p> <p>Answer YES if the unit is in a location in the watershed where the flood storage, or reduction in water velocity, it provides helps protect downstream property and aquatic resources from flooding or excessive and/or erosive flows. Answer NO if the water coming into the wetland is controlled by a structure such as flood gate, tide gate, flap valve, reservoir etc. OR you estimate that more than 90% of the water in the wetland is from groundwater in areas where damaging groundwater flooding does not occur. <i>Note which of the following indicators of opportunity apply.</i></p> <p><input type="checkbox"/> Wetland is in a headwater of a river or stream that has flooding problems.</p> <p><input type="checkbox"/> Wetland drains to a river or stream that has flooding problems</p> <p><input checked="" type="checkbox"/> Wetland has no outlet and impounds surface runoff water that might otherwise flow into a river or stream that has flooding problems</p> <p><input type="checkbox"/> Other _____</p> <p><b>YES multiplier is 2</b>                      NO multiplier is 1</p>	<p>(see p. 49)</p> <p>Multiplier</p> <p><u>X2</u></p>
◆	<p><b>TOTAL – Hydrologic Functions</b>                      Multiply the score from D3 by D4; then <i>add score to table on p. 1</i></p>	<p>14</p>

**Comments: Adjacent property owner said this area floods in winter.**

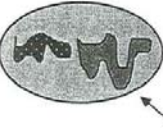
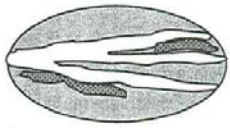
<i>These questions apply to wetlands of all HGM classes.</i> HABITAT FUNCTIONS – Indicators that wetland functions to provide important habitat.		<b>Points</b> (only 1 score per box)											
<b>H 1</b>	<b>Does the wetland have the <u>potential</u> to provide habitat for many species?</b>	<b>Figure</b> ____											
	H 1.1 <u>Vegetation structure</u> (see P. 72): Check the types of vegetation classes present (as defined by Cowardin) – Size threshold for each class is 1/4 acre or more than 10% of the area if unit is smaller than 2.5 acres. <input type="checkbox"/> Aquatic Bed <input type="checkbox"/> Emergent plants <input checked="" type="checkbox"/> Scrub/shrub (areas where shrubs have > 30% cover) <input type="checkbox"/> Forested (areas where trees have > 30% cover) If the unit has a forested class check if: <input type="checkbox"/> The forested class has 3 out of 5 strata (canopy, sub-canopy, shrubs, herbaceous, moss/ground-cover) that each cover 20% within the forested polygon. Add the number of vegetation types that qualify. If you have: <table style="margin-left: 20px;"> <tr> <td>4 structures or more.....</td> <td>points = 4</td> <td><b>Map of Cowardin vegetation classes</b></td> </tr> <tr> <td>3 structures.....</td> <td>points = 2</td> <td>3 structures.....</td> <td>points = 2</td> </tr> <tr> <td>2 structures.....</td> <td>points = 1</td> <td>1 structure.....</td> <td>points = 0</td> </tr> </table>	4 structures or more.....	points = 4	<b>Map of Cowardin vegetation classes</b>	3 structures.....	points = 2	3 structures.....	points = 2	2 structures.....	points = 1	1 structure.....	points = 0	0
4 structures or more.....	points = 4	<b>Map of Cowardin vegetation classes</b>											
3 structures.....	points = 2	3 structures.....	points = 2										
2 structures.....	points = 1	1 structure.....	points = 0										
	H 1.2 <u>Hydroperiods</u> (see p.73): Check the types of water regimes (hydroperiods) present within the wetland. The water regime has to cover more than 10% of the wetland or 1/4 acre to count (see text for descriptions of hydroperiods). <input type="checkbox"/> Permanently flooded or inundated <input checked="" type="checkbox"/> Seasonally flooded or inundated <input type="checkbox"/> Occasionally flooded or inundated <input type="checkbox"/> Saturated only <input type="checkbox"/> Permanently flowing stream or river in, or adjacent to, the wetland <input type="checkbox"/> Seasonally flowing stream in, or adjacent to, the wetland <input type="checkbox"/> <b>Lake-fringe wetland..... = 2 points</b> <input type="checkbox"/> <b>Freshwater tidal wetland..... = 2 points</b>	0											
	H 1.3 <u>Richness of Plant Species</u> (see p. 75): Count the number of plant species in the wetland that cover at least 10 ft <sup>2</sup> (different patches of the same species can be combined to meet the size threshold) You do not have to name the species. Do not include Eurasian Milfoil, reed canarygrass, purple loosestrife, Canadian Thistle. If you counted: <table style="margin-left: 20px;"> <tr> <td>&gt; 19 species.....</td> <td>points = 2</td> </tr> <tr> <td>5 – 19 species.....</td> <td>points = 1</td> </tr> <tr> <td>&lt; 5 species.....</td> <td>points = 0</td> </tr> </table> List species below if you want to: _____ _____ _____	> 19 species.....	points = 2	5 – 19 species.....	points = 1	< 5 species.....	points = 0	1					
> 19 species.....	points = 2												
5 – 19 species.....	points = 1												
< 5 species.....	points = 0												
	H 1.4 <u>Interspersion of Habitats</u> (see p. 76): Decided from the diagrams below whether interspersion between Cowardin vegetation (described in H1.1), or the classes and unvegetated areas (can include open water or mudflats) is high, medium, low, or none. <div style="display: flex; justify-content: space-around; align-items: flex-start;"> <div style="text-align: center;">                           None = 0 points                     </div> <div style="text-align: center;">                           Low = 1 point                     </div> <div style="text-align: center;">                           Moderate = 2 points                     </div> <div style="text-align: center;">                           High = 3 points                     </div> </div> <div style="margin-top: 10px;">                           [riparian braided channels]                     </div> <div style="margin-left: 20px; margin-top: 10px;">                         Note: If you have 4 or more classes or 3 vegetation classes and open water, the rating is always “high”.                           Use map of Cowardin classes.                     </div>	0											
	H 1.5 <u>Special Habitat Features</u> (see p. 77): Check the habitat features that are present in the wetland. The number of checks is the number of points you put into the next column. <ul style="list-style-type: none"> <li><input type="checkbox"/> Large, downed, woody debris within the wetland (&gt; 4 in. diameter and 6 ft. long)</li> <li><input type="checkbox"/> Standing snags (diameter at the bottom &gt; 4 inches) in the wetland</li> <li><input type="checkbox"/> Undercut banks are present for at least 6.6 ft. (2m) and/or overhanging vegetation extends at least 3.3 ft. (1m) over a stream (or ditch) in, or contiguous with the unit, for at least 33 ft. (10m)</li> <li><input type="checkbox"/> Stable steep banks of fine material that might be used by beaver or muskrat for denning (&gt; 30 degree slope) OR signs of recent beaver activity are present (cut shrubs or trees that have not yet turned grey/brown)</li> <li><input type="checkbox"/> At least 1/4 acre of thin-stemmed persistent vegetation or woody branches are present in areas that are permanently or seasonally inundated (structures for egg-laying by amphibians)</li> <li><input type="checkbox"/> Invasive plants cover less than 25% of the wetland area in each stratum of plants</li> </ul> NOTE: The 20% stated in early printings of the manual on page 78 is an error.	0											
<b>H 1 TOTAL Score</b> – potential for providing habitat		Add the points in the column to the right. <span style="color: red; font-weight: bold;">Exhibit 16</span> <span style="color: red; font-weight: bold;">SSDP2016-00415</span> <span style="color: red; font-weight: bold;">001062</span>											
		1											

<b>H 2</b>	<b>Does the wetland have the <u>opportunity</u> to provide habitat for many species?</b>	(only 1 score per box)
	<p>H 2.1 <u>Buffers</u> (see P. 80):  <i>Choose the description that best represents condition of buffer of wetland unit. The highest scoring criterion that applies to the wetland is to be used in the rating. See text for definition of "undisturbed".</i></p> <p><input type="checkbox"/> 100m (330 ft) of relatively undisturbed vegetated areas, rocky areas, or open water &gt; 95% of circumference. No structures are within the undisturbed part of buffer (relatively undisturbed also means no grazing, no landscaping, no daily human use)..... <b>points = 5</b></p> <p><input type="checkbox"/> 100m (330 ft) of relatively undisturbed vegetated areas, rocky areas, or open water &gt; 50% circumference ..... <b>points = 4</b></p> <p><input type="checkbox"/> 50m (170 ft) of relatively undisturbed vegetated areas, rocky areas, or open water &gt; 95% circumference ..... <b>points = 4</b></p> <p><input type="checkbox"/> 100m (330 ft) of relatively undisturbed vegetated areas, rocky areas, or open water &gt; 25% circumference ..... <b>points = 3</b></p> <p><input type="checkbox"/> 50m (170 ft) of relatively undisturbed vegetated areas, rocky areas, or open water for &gt; 50% circumference ..... <b>points = 3</b></p> <p><b>If buffer does not meet any of the criteria above:</b></p> <p><input type="checkbox"/> No paved areas (except paved trails) or buildings within 25m (80 ft) of wetland &gt; 95% circumference. Light to moderate grazing or lawns are OK ..... <b>points = 2</b></p> <p><input type="checkbox"/> No paved areas of buildings within 50m of wetland for &gt; 50% circumference. Light to moderate grazing or lawns are OK..... <b>points = 2</b></p> <p><input type="checkbox"/> Heavy grazing in buffer ..... <b>points = 1</b></p> <p><input type="checkbox"/> Vegetated buffers are &lt; 2m wide (6.6 ft) for more than 95% circumference (e.g. tilled fields, paving, basalt bedrock extend to edge of wetland) ..... <b>points = 0</b></p> <p><input checked="" type="checkbox"/> Buffer does not meet any of the criteria above ..... <b>points = 1</b></p> <p style="text-align: right;"><b>Arial photo showing buffers</b></p>	<p><b>Figure</b> ____</p> <p style="text-align: center;">1</p>
	<p>H 2.2 <u>Corridors and Connections</u> (see p. 81)</p> <p>H 2.2.1 Is the wetland part of a relatively undisturbed and unbroken vegetated corridor (either riparian or upland) that is at least 150 ft. wide, has at least a 30% cover of shrubs, forest or native undisturbed prairie, that connects to estuaries, other wetlands or undisturbed uplands that are at least 250 acres in size? (<i>Dams in riparian corridors, heavily used gravel roads, paved roads, are considered breaks in the corridor.</i>)</p> <p style="padding-left: 40px;">YES = <b>4 points</b> (go to H 2.3) <span style="float: right;">NO = go to H 2.2.2</span></p> <p>H. 2.2.2 Is the wetland part of a relatively undisturbed and unbroken vegetated corridor (either riparian or upland) that is at least 50 ft. wide, has at least 30% cover of shrubs or forest, and connects to estuaries, other wetlands or undisturbed uplands that are at least 25 acres in size? <b>OR a Lake-fringe</b> wetland, if it does not have an undisturbed corridor as in the question above?</p> <p style="padding-left: 40px;">YES = <b>2 points</b> (go to H 2.3) <span style="float: right;">NO = go to H 2.2.3</span></p> <p>H. 2.2.3 Is the wetland:</p> <ul style="list-style-type: none"> <li>• Within 5 mi (8km) of a brackish or salt water estuary OR</li> <li>• Within 3 miles of a large field or pasture (&gt; 40 acres) OR <span style="float: right;">YES = 1 point</span></li> <li>• <b>Within 1 mile of a lake greater than 20 acres?</b> <span style="float: right;">NO = 0 points</span></li> </ul>	<p style="text-align: center;">1</p>

**Comments:**



	<p>H 2.3 <u>Near or adjacent to other priority habitats listed by WDFW</u> (see p. 82): (see new and complete descriptions of WDFW priority habitats, and the counties in which they can be found, in the PHS report <a href="http://wdfw.wa.gov/hab/phslist.htm">http://wdfw.wa.gov/hab/phslist.htm</a>)</p> <p>Which of the following priority habitats are within 330 ft. (100m) of the wetland unit?  <i>NOTE: the connections do not have to be relatively undisturbed.</i></p> <p><input type="checkbox"/> <b>Aspen Stands:</b> Pure or mixed stands of aspen greater than 0.4 ha (1 acre).</p> <p><input type="checkbox"/> <b>Biodiversity Areas and Corridors:</b> Areas of habitat that are relatively important to various species of native fish and wildlife (full descriptions in WDFW PHS report p. 152).</p> <p><input type="checkbox"/> <b>Herbaceous Balds:</b> Variable size patches of grass and forbs on shallow soils over bedrock.</p> <p><input type="checkbox"/> <b>Old-growth/Mature forests:</b> (Old-growth west of Cascade crest) Stands of at least 2 tree species, forming a multi-layered canopy with occasional small openings; with at least 20 trees/ha (8 trees/acre) &gt; 81 cm (32 in) dbh or &gt; 200 years of age. (Mature forests) Stands with average diameters exceeding 53 cm (21 in) dbh; crown cover may be less than 100%; decay, decadence, numbers of snags, and quantity of large downed material is generally less than that found in old-growth; 80 - 200 years old west of the Cascade crest.</p> <p><input type="checkbox"/> <b>Oregon white Oak:</b> Woodlands Stands of pure oak or oak/conifer associations where canopy coverage of the oak component is important (full descriptions in WDFW PHS report p. 158).</p> <p><input checked="" type="checkbox"/> <b>Riparian:</b> The area adjacent to aquatic systems with flowing water that contains elements of both aquatic and terrestrial ecosystems which mutually influence each other.</p> <p><input type="checkbox"/> <b>Westside Prairies:</b> Herbaceous, non-forested plant communities that can either take the form of a dry prairie or a wet prairie (full descriptions in WDFW PHS report p. 161).</p> <p><input checked="" type="checkbox"/> <b>Instream:</b> The combination of physical, biological, and chemical processes and conditions that interact to provide functional life history requirements for instream fish and wildlife resources.</p> <p><input type="checkbox"/> <b>Nearshore:</b> Relatively undisturbed nearshore habitats. These include Coastal Nearshore, Open Coast Nearshore, and Puget Sound Nearshore. (full descriptions of habitats and the definition of relatively undisturbed are in WDFW report: pp. 167-169 and glossary in Appendix A).</p> <p><input type="checkbox"/> <b>Caves:</b> A naturally occurring cavity, recess, void, or system of interconnected passages under the earth in soils, rock, ice, or other geological formations and is large enough to contain a human.</p> <p><input type="checkbox"/> <b>Cliffs:</b> Greater than 7.6 m (25 ft) high and occurring below 5000 ft.</p> <p><input type="checkbox"/> <b>Talus:</b> Homogenous areas of rock rubble ranging in average size 0.15 - 2.0 m (0.5 - 6.5 ft), composed of basalt, andesite, and/or sedimentary rock, including riprap slides and mine tailings. May be associated with cliffs.</p> <p><input type="checkbox"/> <b>Snags and Logs:</b> Trees are considered snags if they are dead or dying and exhibit sufficient decay characteristics to enable cavity excavation/use by wildlife. Priority snags have a diameter at breast height of &gt; 51 cm (20 in) in western Washington and are &gt; 2 m (6.5 ft) in height. Priority logs are &gt; 30 cm (12 in) in diameter at the largest end, and &gt; 6 m (20 ft) long.</p> <p>If wetland has <b>3 or more</b> priority habitats = <b>4 points</b>                  If wetland has <b>2</b> priority habitats = <b>3 points</b>                  If wetland has <b>1</b> priority habitat = <b>1 point</b>                      No habitats = 0 points</p> <p>Note: All vegetated wetlands are by definition a priority habitat but are not included in this list. Nearby wetlands are addressed in question H 2.4)</p>	2
	<p>H 2.4 <u>Wetland Landscape:</u> Choose the <b>one</b> description of the landscape around the wetland that best fits (see p. 84)</p> <ul style="list-style-type: none"> <li>• There are at least 3 other wetlands within 1/2 mile, and the connections between them are relatively undisturbed (light grazing between wetlands OK, as is lake shore with some boating, but connections should NOT be bisected by paved roads, fill, fields, or other development.....points = 5</li> <li>• The wetland is Lake-fringe on a lake with little disturbance and there are 3 other lake-fringe wetlands within 1/2 mile .....points = 5</li> <li>• There are at least 3 other wetlands within 1/2 mile, BUT the connections between them are disturbed.....points = 3</li> <li>• The wetland fringe on a lake <b>with</b> disturbance and there are 3 other lake-fringe wetlands within 1/2 mile .....points = 3</li> <li>• There is at least 1 wetland within 1/2 mile .....points = 2</li> <li>• There are no wetlands within 1/2 mile.....points = 0</li> </ul>	3
<p><b>H 2 TOTAL Score – opportunity for providing habitat</b>                      Add the scores from H2.1, H2.2, H2.3, H2.4</p>		7
<p style="text-align: right;"><i>TOTAL for H 1 from page 8</i></p>		1
◆	<p><b>Total Score for Habitat Functions</b>                      Add the points for H 1 and H 2; then <b>record the result on p. 1</b></p>	8

Comments:

### CATEGORIZATION BASED ON SPECIAL CHARACTERISTICS

*Please determine if the wetland meets the attributes described below  
and circle the appropriate answers and Category.*

<b>Wetland Type</b> – Check off any criteria that apply to the wetland. Circle the Category when the appropriate criteria are met.	
<b>SC1</b>	<p><b>Estuarine wetlands?</b> (see p.86)</p> <p>Does the wetland unit meet the following criteria for Estuarine wetlands?</p> <p><input type="checkbox"/> The dominant water regime is tidal,  <input type="checkbox"/> Vegetated, and  <input type="checkbox"/> With a salinity greater than 0.5 ppt.</p> <p style="text-align: center;">YES = Go to SC 1.1                      NO = <u>X</u></p>
	<p>SC 1.1 Is the wetland unit within a National Wildlife Refuge, National Park, National Estuary Reserve, Natural Area Preserve, State Park or Educational, Environmental, or Scientific Reserve designated under WAC 332-30-151?    YES = Category I                      NO = go to SC 1.2</p>
	<p>SC 1.2 Is the wetland at least 1 acre in size and meets at least two of the following conditions?          YES = Category I                      NO = Category II</p> <p><input type="checkbox"/> The wetland is relatively undisturbed (has no diking, ditching, filling, cultivation, grazing, and has less than 10% cover of non-native plant species. If the non-native <i>Spartina</i> spp., are only species that cover more than 10% of the wetland, then the wetland should be given a dual rating (I/II). The area of <i>Spartina</i> would be rated a Category II while the relatively undisturbed upper marsh with native species would be a Category I. Do not, however, exclude the area of <i>Spartina</i> in determining the size threshold of 1 acre.</p> <p><input type="checkbox"/> At least 3/4 of the landward edge of the wetland has a 100 ft. buffer of shrub, forest, or un-grazed or un-mowed grassland</p> <p><input type="checkbox"/> The wetland has at least 2 of the following features: tidal channels, depressions with open water, or contiguous freshwater wetlands.</p>
<b>SC2</b>	<p><b>Natural Heritage Wetlands</b> (see p. 87)</p> <p>Natural Heritage wetlands have been identified by the Washington Natural Heritage Program/DNR as either high quality undisturbed wetlands or wetlands that support state Threatened, Endangered, or Sensitive plant species.</p> <p>SC 2.1 Is the wetland being rated in a Section/Township/Range that contains a natural heritage wetland? (<i>This question is used to screen out most sites before you need to contact WNHP/DNR.</i>)          S/T/R information from Appendix D _____ or accessed from WNHP/DNR web site _____          YES _____ Contact WNHP/DNR (see p. 79) and go to SC 2.2                      NO <u>X</u></p> <p>SC 2.2 Has DNR identified the wetland as a high quality undisturbed wetland or as a site with state threatened or endangered plant species?          YES = Category 1                      NO _____ not a Heritage Wetland</p>
<b>SC3</b>	<p><b>Bogs</b> (see p. 87)</p> <p>Does the wetland (or any part of the unit) meet both the criteria for soils and vegetation in bogs? Use the key below to identify if the wetland is a bog. <i>If you answer yes you will still need to rate the wetland based on its function.</i></p> <p>1. Does the unit have organic soil horizons (i.e. layers of organic soil), either peats or mucks, that compose 16 inches or more of the first 32 inches of soil profile? (See Appendix B for a field key to identify organic soils)?    YES = go to question 3                      NO = go to question 2</p> <p>2. Does the wetland have organic soils, either peats or mucks that are less than 16 inches deep over bedrock, or an impermeable hardpan such as clay or volcanic ash, or that are floating on a lake or pond?    YES = go to question 3                      NO = is not a bog for purpose of rating</p> <p>3. Does the unit have more than 70% cover of mosses at ground level, AND other plants, if present, consist of the “bog” species listed in Table 3 as a significant component of the vegetation (more than 30% of the total shrub and herbaceous cover consists of species in Table 3)?          YES = Is a bog for purpose of rating                      NO = go to question 4</p> <p>NOTE: If you are uncertain about the extent of mosses in the understory you may substitute that criterion by measuring the pH of the water that seeps into a hole dug at least 16” deep. If the pH is less than 5.0 and the “bog” plant species in Table 3 are present, the wetland is a bog.</p> <p>4. Is the unit forested (&gt; 30% cover) with sitka spruce, subalpine fir, western red cedar, western hemlock, lodgepole pine, quaking aspen, Englemann’s spruce, or western white pine. WITH any of the species (or combination of species) on the bog species plant list in Table 3 as a significant component of the ground cover (&gt; 30% coverage of the total shrub/herbaceous cover)?          YES = Category I                      NO = Is not a bog for purpose of rating</p>

**Exhibit 16**  
**SSDP2016-00415**  
**001005**

SC4	<p><b>Forested Wetlands</b> (see p. 90)</p> <p>Does the wetland have at least 1 acre of forest that meet one of these criteria for the Department of Fish and Wildlife's forests as priority habitats? <i>If you answer yes you will still need to rate the wetland based on its function.</i></p> <p>___ <b>Old-growth forests:</b> (west of Cascade Crest) Stands of at least two three species forming a multi-layered canopy with occasional small openings; with at least 8 trees/acre (20 trees/hectare) that are at least 200 years of age OR have a diameter at breast height (dbh) of 32 inches (81 cm or more).</p> <p>NOTE: The criterion for dbh is based on measurements for upland forests. Two-hundred year old trees in wetlands will often have a smaller dbh because their growth rates are often slower. The DFW criterion is and "OR" so old-growth forests do not necessarily have to have trees of this diameter.</p> <p>___ <b>Mature forests:</b> (west of the Cascade Crest) Stands where the largest trees are 80 – 200 years old OR have an average diameters (dbh) exceeding 21 inches (53 cm); crown cover may be less than 100%; decay, decadence, numbers of snags, and quantity of large downed material is generally less than that found in old-growth.</p> <p>YES = Category I                      NO = <u>X</u> not a forested wetland with special characteristics</p>	Cat. I
SC5	<p><b>Wetlands in Coastal Lagoons</b> (see p. 91)</p> <p>Does the wetland meet all of the following criteria of a wetland in a coastal lagoon?</p> <p>___ The wetland lies in a depression adjacent to marine waters that is wholly or partially separated from marine waters by sandbanks, gravel banks, shingle, or, less frequently, rocks.</p> <p>___ The lagoon in which the wetland is located contains surface water that is saline or brackish (&gt; 0.5 ppt) during most of the year in at least a portion of the lagoon (<i>needs to be measured near the bottom.</i>)</p> <p>YES = Go to SC 5.1                      NO <u>X</u> not a wetland in a coastal lagoon</p> <p>SC 5.1 Does the wetland meet all of the following three conditions?</p> <p>___ The wetland is relatively undisturbed (has no diking, ditching, filling, cultivation, grazing) and has less than 20% cover of invasive plant species (see list of invasive species on p. 74).</p> <p>___ At least 3/4 of the landward edge of the wetland has a 100 ft. buffer of shrub, forest, or un-grazed or un-mowed grassland.</p> <p>___ The wetland is larger than 1/10 acre (4350 square ft.)</p> <p>YES = Category I                      NO = Category II</p>	Cat. I Cat. II
SC6	<p><b>Interdunal Wetlands</b> (see p. 93)</p> <p>Is the wetland west of the 1889 line (also called the Western Boundary of Upland Ownership or WBUO)?</p> <p>YES = Go to SC 6.1                      NO <u>X</u> not an interdunal wetland for rating</p> <p><i>If you answer yes you will still need to rate the wetland based on its functions.</i></p> <p>In practical terms that means the following geographic areas:</p> <ul style="list-style-type: none"> <li>• Long Beach Peninsula -- lands west of SR 103</li> <li>• Grayland-Westport -- lands west of SR 105</li> <li>• Ocean Shores-Copalis – lands west of SR 115 and SR 109</li> </ul> <p>SC 6.1 Is the wetland one acre or larger, or is it in a mosaic of wetlands that is one acre or larger?</p> <p>YES = Category II                      NO = go to SC 6.2</p> <p>SC 6.2 Is the wetland between 0.1 and 1 acre, or is it in a mosaic of wetlands that is between 0.1 and 1 acre?</p> <p>YES = Category III</p>	Cat. II Cat. III
◆	<p><b>Category of wetland based on Special Characteristics</b></p> <p>Choose the "highest" rating if wetland falls into several categories, and record on p. 1.</p> <p>If you answered NO for all types enter "Not Applicable" on p. 1</p>	NA

Comments:

**Exhibit 16**  
**SSDP2016-00415**  
**001006**

Wetland name or number 19A

**WETLAND RATING FORM – WESTERN WASHINGTON**  
Version 2 – Updated July 2006 to increase accuracy and reproducibility among users  
Updated Oct. 2008 with the new WDFW definitions for priority habitats

Name of wetland (if known): 19A Date of site visit: 09-12-13

Rated by: Colin Worsley / Matt Maynard Trained by Ecology? Yes X No      Date of training: 11-2005 / 04-2006

SEC: 06 TOWNSHIP: 24N RANGE: 06E Is S/T/R in Appendix D? Yes      No X

Map of wetland unit: Figure      Estimated size 0.02 acre

**SUMMARY OF RATING**

Category based on FUNCTIONS provided by wetland: I      II      III      IV X

Category I =	Score > 70
Category II =	Score 51 - 69
Category III =	Score 30 – 50
Category IV =	Score < 30

Score for Water Quality Functions	12
Score for Hydrologic Functions	8
Score for Habitat Functions	7
<b>TOTAL Score for Functions</b>	<b>27</b>

Category based on SPECIAL CHARACTERISTICS of Wetland I      II      Does not apply X

**Final Category** (choose the “highest” category from above”) **IV**

**Summary of basic information about the wetland unit.**

Wetland Unit has Special Characteristics		Wetland HGM Class used for Rating	
<b>Estuarine</b>		<b>Depressional</b>	<b>X</b>
<b>Natural Heritage Wetland</b>		<b>Riverine</b>	
<b>Bog</b>		<b>Lake-fringe</b>	
<b>Mature Forest</b>		<b>Slope</b>	
<b>Old Growth Forest</b>		<b>Flats</b>	
<b>Coastal Lagoon</b>		<b>Freshwater Tidal</b>	
<b>Interdunal</b>			
None of the above	X	Check if unit has multiple HGM classes present	<span style="border: 1px solid black; padding: 2px 10px;">    </span>

**Does the wetland being rated meet any of the criteria below?** If you answer YES to any of the questions below you will need to protect the wetland according to the regulations regarding the special characteristics found in the wetland.

Check List for Wetlands that Need Additional Protection (in addition to the protection recommended for its category)	YES	NO
SP1. <i>Has the wetland unit been documented as a habitat for any Federally listed Threatened or Endangered <b>animal or plant</b> species (T/E species)?</i> For the purposes of this rating system, “documented” means the wetland is on the appropriate state or federal database.		X
SP2. <i>Has the wetland unit been documented as habitat for any State listed Threatened or Endangered <b>animal</b> species?</i> For the purposes of this rating system, “documented” means the wetland is on the appropriate state database. Note: Wetlands with State listed plant species are categorized as Category 1 Natural Heritage Wetlands (see p. 19 of data form).		X
SP3. <i>Does the wetland unit contain individuals of Priority species listed by the WDFW for the state?</i>		X
SP4. <i>Does the wetland unit have a local significance in addition to its functions?</i> For example, the wetland has been identified in the Shoreline Master Program, the Critical Areas Ordinance, or in a local management plan as having special significance.		X

To complete the next part of the data sheet you will need to determine the Hydrogeomorphic Class of the wetland being rated.

Exhibit 16  
SSDP2016-00415  
09/09/07

### Classification of Vegetated Wetlands for Western Washington

If the hydrologic criteria listed in each question do not apply to the entire unit being rated, you probably have a unit with multiple HGM classes. In this case, identify which hydrologic criteria in questions 1-7 apply, and go to Question 8.

1. Are the water levels in the entire unit usually controlled by tides (i.e. except during floods)?  
NO – go to 2                      **YES – the wetland class is Tidal Fringe**  
 If yes, is the salinity of the water during periods of annual low flow below 0.5 ppt (parts per thousand)?  
**YES – Freshwater Tidal Fringe**                      **NO – Saltwater Tidal Fringe (Estuarine)**  
*If your wetland can be classified as a Freshwater Tidal Fringe use the forms for Riverine wetlands. If it is a Saltwater Tidal Fringe it is rated as an Estuarine wetland. Wetlands that were call estuarine in the first and second editions of the rating system are called Salt Water Tidal Fringe in the Hydrogeomorphic Classification. Estuarine wetlands were categorized separately in the earlier editions, and this separation is being kept in this revision. To maintain consistency between editions, the term “Estuarine” wetland is kept. Please note, however, that the characteristics that define Category I and II estuarine wetlands have changed (see p. \_\_\_\_).*

---

2. The entire wetland unit is flat and precipitation is only source (>90%) of water to it. Groundwater and surface water runoff are NOT sources of water to the unit.  
NO – go to 3                      **YES – The wetland class is Flats**  
 If your wetland can be classified as a “Flats” wetland, use the form for **Depressional** wetlands.

---

3. Does the entire wetland meet both of the following criteria?  
 \_\_\_\_\_ The vegetated part of the wetland is on the shores of a body of permanent open water (without any vegetation on the surface) where at least 20 acres (8ha) in size;  
 \_\_\_\_\_ At least 30% of the open water area is deeper than 6.6 (2 m)?  
NO – go to 4                      **YES – The wetland class is Lake-fringe (Lacustrine Fringe)**

---

4. Does the entire wetland meet all of the following criteria?  
 \_\_\_\_\_ The wetland is on a slope (*slope can be very gradual*).  
 \_\_\_\_\_ The water flows through the wetland in one direction (unidirectional) and usually comes from seeps. It may flow subsurface, as sheetflow, or in a swale without distinct banks.  
 \_\_\_\_\_ The water leaves the wetland **without being impounded**?  
 NOTE: *Surface water does not pond in these types of wetlands except occasionally in very small and shallow depressions or behind hummocks (depressions are usually <3 ft diameter and less than 1 foot deep).*  
NO – go to 5                      **YES – The wetland class is Slope**

---

5. Does the entire wetland meet all of the following criteria?  
 \_\_\_\_\_ The unit is in a valley or stream channel where it gets inundated by overbank flooding from that stream or river.  
 \_\_\_\_\_ The overbank flooding occurs at least once every two years.  
 NOTE: *The riverine unit can contain depressions that are filled with water when the river is not flooding..*  
NO – go to 6                      **YES – The wetland class is Riverine**

---

6. Is the entire wetland unit in a topographic depression in which water ponds, or is saturated to the surface, at some time of the year. This means that any outlet, if present is higher than the interior of the wetland.  
NO – go to 7                      **YES – The wetland class is Depressional**

---

7. Is the entire wetland located in a very flat area with no obvious depression and no overbank flooding. The unit does not pond surface water more than a few inches. The unit seems to be maintained by high groundwater in the area. The wetland may be ditched, but has no obvious natural outlet.  
No – go to 8                      **YES – The wetland class is Depressional**

---

8. Your wetland unit seems to be difficult to classify and probably contains several different HGM classes. For example, seeps at the base of a slope may grade into a riverine floodplain, or a small stream within a depressional wetland has a zone of flooding along its sides. **GO BACK AND IDENTIFY WHICH OF THE HYDROLOGIC REGIMES DESCRIBED IN QUESTIONS 1-7 APPLY TO DIFFERENT AREAS IN THE UNIT** (make a rough sketch to help you decide). Use the following table to identify the appropriate class to use for the rating system if you have several HGM classes present within your wetland. NOTE: Use this table only if the class that is recommended in the second column represents 10% or more of the total area of the wetland unit being rated. If the area of the class listed in column 2 is less than 10% of the unit, classify the wetland using the class that represents more than 90% of the total area.

HGM Classes within the wetland unit being rated	HGM Class to Use in Rating
Slope + Riverine	Riverine
Slope + Depressional	Depressional
Slope + Lake-fringe	Lake-fringe
Depressional + Riverine along stream within boundary	Depressional
Depressional + Lake-fringe	Depressional
Salt Water Tidal Fringe and any other class of freshwater wetland	Treat as ESTUARINE under wetlands with special characteristics

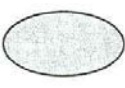
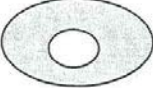



**Exhibit 16**  
**SSDP2016-00415**  
**001008**

If you are unable still to determine which of the above criteria apply to your wetland, or you have more than 2 HGM classes within a wetland boundary, classify the wetland as **Depressional** for the rating.

<b>D Depressional and Flat Wetlands</b>		<b>Points</b>
WATER QUALITY FUNCTIONS – Indicators that wetland functions to improve water quality.		(only 1 score per box) (see p.38)
<b>D 1</b>	<b>Does the wetland have the potential to improve water quality?</b>	
D 1.1	Characteristics of surface water flows out of the wetland: <ul style="list-style-type: none"> <li>• Unit is a depression with no surface water leaving it (no outlet)..... points = 3</li> <li>• Unit has an intermittently flowing, OR highly constricted, permanently flowing outlet ..... points = 2</li> <li>• Unit has an unconstricted, or slightly constricted, surface outlet (<i>permanently flowing</i>) ..... points = 1</li> <li>• Unit is a “flat” depression (Q.7 on key), or in the Flats class, with permanent surface outflow <b>and no obvious natural outlet</b> and/or outlet is a man-made ditch..... points = 1 <i>(If ditch is not permanently flowing treat unit as “intermittently flowing”)</i> <b>Provide photo or drawing</b></li> </ul>	<b>Figure</b> ____  3
D 1.2	The soil 2 inches below the surface (or duff layer) is clay or organic ( <i>use NRCS definitions</i> ) YES points = 4                                  NO points = 0	0
D 1.3	Characteristics of persistent vegetation (emergent, shrub, and/or forest Cowardin class): <ul style="list-style-type: none"> <li>• Wetland has persistent, ungrazed vegetation &gt; = 95% of area..... points = 5</li> <li>• Wetland has persistent, ungrazed vegetation &gt; = 1/2 of area..... points = 3</li> <li>• Wetland has persistent, ungrazed vegetation &gt; = 1/10 of area..... points = 1</li> <li>• Wetland has persistent, ungrazed vegetation &lt; 1/10 of area..... points = 0</li> </ul> <p style="text-align: center;"><b>Map of Cowardin vegetation classes</b></p>	<b>Figure</b> ____  1
D 1.4	Characteristics of seasonal ponding or inundation: <i>This is the area of the wetland that is ponded for at least 2 months, but dries out sometime during the year. Do not count the area that is permanently ponded. Estimate area as the average condition 5 out of 10 years.</i> <ul style="list-style-type: none"> <li>• Area seasonally ponded is &gt; 1/2 total area of wetland ..... points = 4</li> <li>• Area seasonally ponded is &gt; 1/4 total area of wetland ..... points = 2</li> <li>• Area seasonally ponded is &lt; 1/4 total area of wetland ..... points = 0</li> </ul> <p style="text-align: center;"><b>Map of Hydroperiods</b></p>	<b>Figure</b> ____  2
<b>Total for D 1</b>		Add the points in the boxes above <b>6</b>
<b>D 2</b>	<b>Does the wetland have the opportunity to improve water quality?</b> Answer YES if you know or believe there are pollutants in groundwater or surface water coming into the wetland that would otherwise reduce water quality in streams, lakes or groundwater downgradient from the wetland? <i>Note which of the following conditions provide the sources of pollutants. A unit may have pollutants coming from several sources, but any single source would qualify as opportunity.</i> ___ Grazing in the wetland or within 150 ft ___ Untreated stormwater discharges to wetland ___ Tilled fields or orchards within 150 ft. of wetland ___ A stream or culvert discharges into wetland that drains developed areas, residential areas, farmed fields, roads, or clear-cut logging <input checked="" type="checkbox"/> Residential, urban areas, golf courses are within 150 ft. of wetland ___ Wetland is fed by groundwater high in phosphorus or nitrogen ___ Other _____ YES multiplier is 2                                  NO multiplier is 1	(see p. 44)          Multiplier  X2
◆ <b>TOTAL – Water Quality Functions</b> Multiply the score from D1 by D2; then <i>add score to table on p. 1</i>		12
HYDROLOGIC FUNCTIONS – Indicators that wetland unit functions to reduce flooding and stream degradation.		
<b>D 3</b>	<b>Does the wetland have the potential to reduce flooding and erosion?</b>	(see p.46)
D 3.1	Characteristics of surface water flows out of the wetland unit <ul style="list-style-type: none"> <li>• Unit is a depression with no surface water leaving it (no outlet)..... points = 4</li> <li>• Unit has an intermittently flowing, OR highly constricted permanently flowing outlet ..... points = 2</li> <li>• Unit is a “flat” depression (Q.7 on key) or in the Flats class, with permanent surface outflow <b>and no obvious natural outlet</b> and/or outlet is a man-made ditch..... points = 1 <i>(If ditch is not permanently flowing treat unit as “intermittently flowing”)</i></li> <li>• Unit has an unconstricted, or slightly constricted, surface outlet (<i>permanently flowing</i>) ..... points = 0</li> </ul>	4
D 3.2	Depth of storage during wet periods. <i>Estimate the height of ponding above the bottom of the outlet. For units with no outlet measure from the surface of permanent water or deepest part (if dry).</i> <ul style="list-style-type: none"> <li>• Marks of ponding are 3 ft. or more above the surface or bottom of the outlet ..... points = 7</li> <li>• The wetland is a “headwater” wetland..... points = 5</li> <li>• Marks of ponding between 2 ft. to &lt; 3 ft. from surface or bottom of outlet ..... points = 5</li> <li>• Marks are at least 0.5 ft. to &lt; 2 ft. from surface or bottom of outlet ..... points = 3</li> <li>• Wetland is flat (yes to Q.2 or Q.7 on key)but has small depressions on the surface that trap water points = 1</li> <li>• Marks of ponding less than 0.5 ft ..... points = 0</li> </ul>	0
D 3.3	Contribution of wetland unit to storage in the watershed: <i>Estimate the ratio of the area of upstream basin contributing surface water to the wetland to the area of the wetland unit itself.</i> <ul style="list-style-type: none"> <li>• The area of the basin is less than 10 times the area of unit..... points = 5</li> <li>• The area of the basin is 10 to 100 times the area of the unit ..... points = 3</li> <li>• The area of the basin is more than 100 times the area of the unit..... points = 0</li> <li>• Entire unit is in the FLATS class ..... points = 5</li> </ul>	0
<b>Total for D 3</b>		Add the points in the boxes above <b>4</b>

<b>D 4</b>	<p><b>Does the wetland have the <u>opportunity</u> to reduce flooding and erosion?</b></p> <p>Answer YES if the unit is in a location in the watershed where the flood storage, or reduction in water velocity, it provides helps protect downstream property and aquatic resources from flooding or excessive and/or erosive flows. Answer NO if the water coming into the wetland is controlled by a structure such as flood gate, tide gate, flap valve, reservoir etc. OR you estimate that more than 90% of the water in the wetland is from groundwater in areas where damaging groundwater flooding does not occur. <i>Note which of the following indicators of opportunity apply.</i></p> <p><input type="checkbox"/> Wetland is in a headwater of a river or stream that has flooding problems.</p> <p><input type="checkbox"/> Wetland drains to a river or stream that has flooding problems</p> <p><input checked="" type="checkbox"/> Wetland has no outlet and impounds surface runoff water that might otherwise flow into a river or stream that has flooding problems</p> <p><input type="checkbox"/> Other _____</p> <p><b>YES multiplier is 2</b>                      NO multiplier is 1</p>	<p>(see p. 49)</p> <p>Multiplier</p> <p><u>X2</u></p>
◆	<p><b>TOTAL – Hydrologic Functions</b>                      Multiply the score from D3 by D4; then <i>add score to table on p. 1</i></p>	<p>8</p>

Comments:

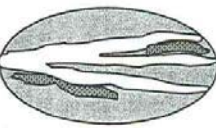
<p><i>These questions apply to wetlands of all HGM classes.</i></p> <p>HABITAT FUNCTIONS – Indicators that wetland functions to provide important habitat.</p>		<p><b>Points</b> (only 1 score per box)</p>
<p><b>H 1 Does the wetland have the potential to provide habitat for many species?</b></p>		
<p>H 1.1 <u>Vegetation structure</u> (see P. 72):                      Check the types of vegetation classes present (as defined by Cowardin) – Size threshold for each class is 1/4 acre or more than 10% of the area if unit is smaller than 2.5 acres.  <input type="checkbox"/> Aquatic Bed  <input checked="" type="checkbox"/> Emergent plants  <input type="checkbox"/> Scrub/shrub (areas where shrubs have &gt; 30% cover)  <input type="checkbox"/> Forested (areas where trees have &gt; 30% cover)                      If the unit has a forested class check if:  <input type="checkbox"/> The forested class has 3 out of 5 strata (canopy, sub-canopy, shrubs, herbaceous, moss/ground-cover) that each cover 20% within the forested polygon.                      Add the number of vegetation types that qualify. If you have:                      4 structures or more..... points = 4                      3 structures..... points = 2                      2 structures..... points = 1</p>	<p><b>Map of Cowardin vegetation classes</b>                      3 structures..... points = 2                      1 structure..... points = 0</p>	<p>Figure ____</p> <p>0</p>
<p>H 1.2 <u>Hydroperiods</u> (see p.73):                      Check the types of water regimes (hydroperiods) present within the wetland. The water regime has to cover more than 10% of the wetland or 1/4 acre to count (see text for descriptions of hydroperiods).  <input type="checkbox"/> Permanently flooded or inundated  <input checked="" type="checkbox"/> Seasonally flooded or inundated  <input type="checkbox"/> Occasionally flooded or inundated  <input checked="" type="checkbox"/> Saturated only  <input type="checkbox"/> Permanently flowing stream or river in, or adjacent to, the wetland  <input type="checkbox"/> Seasonally flowing stream in, or adjacent to, the wetland  <input type="checkbox"/> Lake-fringe wetland..... = 2 points  <input type="checkbox"/> Freshwater tidal wetland..... = 2 points</p>	<p>4 or more types present points = 3                      3 or more types present..... points = 2                      2 types present..... points = 1                      1 type present ..... points = 0</p> <p><b>Map of hydroperiods</b></p>	<p>Figure ____</p> <p>1</p>
<p>H 1.3 <u>Richness of Plant Species</u> (see p. 75):                      Count the number of plant species in the wetland that cover at least 10 ft<sup>2</sup> (different patches of the same species can be combined to meet the size threshold)                      You do not have to name the species. Do not include Eurasian Milfoil, reed canarygrass, purple loosestrife, Canadian Thistle.                      If you counted: &gt; 19 species ..... points = 2                      5 – 19 species..... points = 1                      &lt; 5 species ..... points = 0                      List species below if you want to:                      _____                      _____                      _____</p>	<p>5 – 19 species..... points = 1</p>	<p>1</p>
<p>H 1.4 <u>Interspersion of Habitats</u> (see p. 76):                      Decided from the diagrams below whether interspersion between Cowardin vegetation (described in H1.1), or the classes and unvegetated areas (can include open water or mudflats) is high, medium, low, or none.</p> <div style="display: flex; justify-content: space-around;"> <div style="text-align: center;">  <p>None = 0 points</p> </div> <div style="text-align: center;">  <p>Low = 1 point</p> </div> <div style="text-align: center;">  <p>Moderate = 2 points</p> </div> <div style="text-align: center;">  </div> </div> <div style="display: flex; justify-content: space-around; margin-top: 20px;"> <div style="text-align: center;">  </div> <div style="text-align: center;">  <p>High = 3 points</p> </div> <div style="text-align: center;">  <p>[riparian braided channels]</p> </div> </div> <p>Note: If you have 4 or more classes or 3 vegetation classes and open water, the rating is always “high”.  Use map of Cowardin classes.</p>	<p>Figure ____</p> <p>0</p>	
<p>H 1.5 <u>Special Habitat Features</u> (see p. 77):                      Check the habitat features that are present in the wetland. The number of checks is the number of points you put into the next column.  <input type="checkbox"/> Large, downed, woody debris within the wetland (&gt; 4 in. diameter and 6 ft. long)  <input type="checkbox"/> Standing snags (diameter at the bottom &gt; 4 inches) in the wetland  <input type="checkbox"/> Undercut banks are present for at least 6.6 ft. (2m) and/or overhanging vegetation extends at least 3.3 ft. (1m) over a stream (or ditch) in, or contiguous with the unit, for at least 33 ft. (10m)  <input type="checkbox"/> Stable steep banks of fine material that might be used by beaver or muskrat for denning (&gt; 30 degree slope) OR signs of recent beaver activity are present (cut shrubs or trees that have not yet turned grey/brown)  <input type="checkbox"/> At least 1/4 acre of thin-stemmed persistent vegetation or woody branches are present in areas that are permanently or seasonally inundated (structures for egg-laying by amphibians)  <input type="checkbox"/> Invasive plants cover less than 25% of the wetland area in each stratum of plants                      NOTE: The 20% stated in early printings of the manual on page 78 is an error.</p>	<p>0</p>	<p>0</p>
<p><b>H 1 TOTAL Score – potential for providing habitat</b></p>		<p>Add the points in the column.</p> <p><b>00001</b></p>





	<p>H 2.3 <u>Near or adjacent to other priority habitats listed by WDFW</u> (see p. 82): (see new and complete descriptions of WDFW priority habitats, and the counties in which they can be found, in the PHS report <a href="http://wdfw.wa.gov/hab/phslist.htm">http://wdfw.wa.gov/hab/phslist.htm</a> )</p> <p>Which of the following priority habitats are within 330 ft. (100m) of the wetland unit?  <i>NOTE: the connections do not have to be relatively undisturbed.</i></p> <p>___ <b>Aspen Stands:</b> Pure or mixed stands of aspen greater than 0.4 ha (1 acre).</p> <p>___ <b>Biodiversity Areas and Corridors:</b> Areas of habitat that are relatively important to various species of native fish and wildlife (full descriptions in WDFW PHS report p. 152).</p> <p>___ <b>Herbaceous Balds:</b> Variable size patches of grass and forbs on shallow soils over bedrock.</p> <p>___ <b>Old-growth/Mature forests:</b> (Old-growth west of Cascade crest) Stands of at least 2 tree species, forming a multi-layered canopy with occasional small openings; with at least 20 trees/ha (8 trees/acre) &gt; 81 cm (32 in) dbh or &gt; 200 years of age. (Mature forests) Stands with average diameters exceeding 53 cm (21 in) dbh; crown cover may be less than 100%; decay, decadence, numbers of snags, and quantity of large downed material is generally less than that found in old-growth; 80 - 200 years old west of the Cascade crest.</p> <p>___ <b>Oregon white Oak:</b> Woodlands Stands of pure oak or oak/conifer associations where canopy coverage of the oak component is important (full descriptions in WDFW PHS report p. 158).</p> <p>___ <b>Riparian:</b> The area adjacent to aquatic systems with flowing water that contains elements of both aquatic and terrestrial ecosystems which mutually influence each other.</p> <p>___ <b>Westside Prairies:</b> Herbaceous, non-forested plant communities that can either take the form of a dry prairie or a wet prairie (full descriptions in WDFW PHS report p. 161).</p> <p>___ <b>Instream:</b> The combination of physical, biological, and chemical processes and conditions that interact to provide functional life history requirements for instream fish and wildlife resources.</p> <p>___ <b>Nearshore:</b> Relatively undisturbed nearshore habitats. These include Coastal Nearshore, Open Coast Nearshore, and Puget Sound Nearshore. (full descriptions of habitats and the definition of relatively undisturbed are in WDFW report: pp. 167-169 and glossary in Appendix A).</p> <p>___ <b>Caves:</b> A naturally occurring cavity, recess, void, or system of interconnected passages under the earth in soils, rock, ice, or other geological formations and is large enough to contain a human.</p> <p>___ <b>Cliffs:</b> Greater than 7.6 m (25 ft) high and occurring below 5000 ft.</p> <p>___ <b>Talus:</b> Homogenous areas of rock rubble ranging in average size 0.15 - 2.0 m (0.5 - 6.5 ft), composed of basalt, andesite, and/or sedimentary rock, including riprap slides and mine tailings. May be associated with cliffs.</p> <p>___ <b>Snags and Logs:</b> Trees are considered snags if they are dead or dying and exhibit sufficient decay characteristics to enable cavity excavation/use by wildlife. Priority snags have a diameter at breast height of &gt; 51 cm (20 in) in western Washington and are &gt; 2 m (6.5 ft) in height. Priority logs are &gt; 30 cm (12 in) in diameter at the largest end, and &gt; 6 m (20 ft) long.</p> <p>If wetland has <b>3 or more</b> priority habitats = <b>4 points</b>                  If wetland has <b>2</b> priority habitats = <b>3 points</b>                  If wetland has <b>1</b> priority habitat = <b>1 point</b>                      <b>No habitats = 0 points</b></p> <p>Note: All vegetated wetlands are by definition a priority habitat but are not included in this list. Nearby wetlands are addressed in question H 2.4)</p>	0
	<p>H 2.4 <u>Wetland Landscape:</u> Choose the <b>one</b> description of the landscape around the wetland that best fits (see p. 84)</p> <ul style="list-style-type: none"> <li>• There are at least 3 other wetlands within 1/2 mile, and the connections between them are relatively undisturbed (light grazing between wetlands OK, as is lake shore with some boating, but connections should NOT be bisected by paved roads, fill, fields, or other development.....points = 5</li> <li>• The wetland is Lake-fringe on a lake with little disturbance and there are 3 other lake-fringe wetlands within 1/2 mile .....points = 5</li> <li>• <b>There are at least 3 other wetlands within 1/2 mile, BUT the connections between them are disturbed.....points = 3</b></li> <li>• The wetland fringe on a lake <b>with</b> disturbance and there are 3 other lake-fringe wetlands within 1/2 mile .....points = 3</li> <li>• There is at least 1 wetland within 1/2 mile .....points = 2</li> <li>• There are no wetlands within 1/2 mile.....points = 0</li> </ul>	3
<b>H 2 TOTAL Score – opportunity for providing habitat</b> <i>Add the scores from H2.1, H2.2, H2.3, H2.4</i>		5
<i>TOTAL for H 1 from page 8</i>		2
◆	<b>Total Score for Habitat Functions</b> Add the points for H 1 and H 2; then <b>record the result on p. 1</b>	7

Comments:

**CATEGORIZATION BASED ON SPECIAL CHARACTERISTICS**

**Please determine if the wetland meets the attributes described below  
and circle the appropriate answers and Category.**

<b>Wetland Type</b> – Check off any criteria that apply to the wetland. Circle the Category when the appropriate criteria are met.	
<b>SC1</b>	<p><b>Estuarine wetlands?</b> (see p.86)</p> <p>Does the wetland unit meet the following criteria for Estuarine wetlands?</p> <p><input type="checkbox"/> The dominant water regime is tidal,</p> <p><input type="checkbox"/> Vegetated, and</p> <p><input type="checkbox"/> With a salinity greater than 0.5 ppt.</p> <p>YES = Go to SC 1.1                                  NO <u>X</u></p>
	<p>SC 1.1 Is the wetland unit within a National Wildlife Refuge, National Park, National Estuary Reserve, Natural Area Preserve, State Park or Educational, Environmental, or Scientific Reserve designated under WAC 332-30-151?    YES = Category I                                  NO = go to SC 1.2                                  <b>Cat. 1</b></p>
	<p>SC 1.2 Is the wetland at least 1 acre in size and meets at least two of the following conditions?</p> <p>YES = Category I                                  NO = Category II</p> <p><input type="checkbox"/> The wetland is relatively undisturbed (has no diking, ditching, filling, cultivation, grazing, and has less than 10% cover of non-native plant species. If the non-native <i>Spartina</i> spp. are only species that cover more than 10% of the wetland, then the wetland should be given a dual rating (I/II). The area of <i>Spartina</i> would be rated a Category II while the relatively undisturbed upper marsh with native species would be a Category I. Do not, however, exclude the area of <i>Spartina</i> in determining the size threshold of 1 acre.</p> <p><input type="checkbox"/> At least 3/4 of the landward edge of the wetland has a 100 ft. buffer of shrub, forest, or un-grazed or un-mowed grassland</p> <p><input type="checkbox"/> The wetland has at least 2 of the following features: tidal channels, depressions with open water, or contiguous freshwater wetlands.</p> <p><b>Cat. I</b> <b>Cat. II</b> <b>Dual Rating I/II</b></p>
<b>SC2</b>	<p><b>Natural Heritage Wetlands</b> (see p. 87)</p> <p>Natural Heritage wetlands have been identified by the Washington Natural Heritage Program/DNR as either high quality undisturbed wetlands or wetlands that support state Threatened, Endangered, or Sensitive plant species.</p> <p>SC 2.1 Is the wetland being rated in a Section/Township/Range that contains a natural heritage wetland? (This question is used to screen out most sites before you need to contact WNHP/DNR.) S/T/R information from Appendix D _____ or accessed from WNHP/DNR web site _____ YES _____ Contact WNHP/DNR (see p. 79) and go to SC 2.2                                  NO <u>X</u></p> <p>SC 2.2 Has DNR identified the wetland as a high quality undisturbed wetland or as a site with state threatened or endangered plant species? YES = Category 1                                  NO _____ not a Heritage Wetland</p> <p><b>Cat I</b></p>
<b>SC3</b>	<p><b>Bogs</b> (see p. 87)</p> <p>Does the wetland (<b>or any part of the unit</b>) meet both the criteria for soils and vegetation in bogs? Use the key below to identify if the wetland is a bog. <b>If you answer yes you will still need to rate the wetland based on its function.</b></p> <p>1. Does the unit have organic soil horizons (i.e. layers of organic soil), either peats or mucks, that compose 16 inches or more of the first 32 inches of soil profile? (See Appendix B for a field key to identify organic soils)?    YES = go to question 3                                  <b>NO = go to question 2</b></p> <p>2. Does the wetland have organic soils, either peats or mucks that are less than 16 inches deep over bedrock, or an impermeable hardpan such as clay or volcanic ash, or that are floating on a lake or pond?    YES = go to question 3                                  <b>NO = is not a bog for purpose of rating</b></p> <p>3. Does the unit have more than 70% cover of mosses at ground level, AND other plants, if present, consist of the “bog” species listed in Table 3 as a significant component of the vegetation (more than 30% of the total shrub and herbaceous cover consists of species in Table 3)? YES = Is a bog for purpose of rating                                  NO = go to question 4</p> <p>NOTE: If you are uncertain about the extent of mosses in the understory you may substitute that criterion by measuring the pH of the water that seeps into a hole dug at least 16” deep. If the pH is less than 5.0 and the “bog” plant species in Table 3 are present, the wetland is a bog.</p> <p>4. Is the unit forested (&gt; 30% cover) with sitka spruce, subalpine fir, western red cedar, western hemlock, lodgepole pine, quaking aspen, Englemann’s spruce, or western white pine. WITH any of the species (or combination of species) on the bog species plant list in Table 3 as a significant component of the ground cover (&gt; 30% coverage of the total shrub/herbaceous cover)? YES = Category I                                  NO = Is not a bog for purpose of rating</p> <p><b>Cat. I</b></p>

**Exhibit 16**  
**SSDP2016-00415**  
**001014**

<p><b>SC4</b></p>	<p><b>Forested Wetlands</b> (see p. 90)                  Does the wetland have at least 1 acre of forest that meet one of these criteria for the Department of Fish and Wildlife's forests as priority habitats? <i>If you answer yes you will still need to rate the wetland based on its function.</i>                  ___ <b>Old-growth forests:</b> (west of Cascade Crest) Stands of at least two three species forming a multi-layered canopy with occasional small openings; with at least 8 trees/acre (20 trees/hectare) that are at least 200 years of age OR have a diameter at breast height (dbh) of 32 inches (81 cm or more).                  NOTE: The criterion for dbh is based on measurements for upland forests. Two-hundred year old trees in wetlands will often have a smaller dbh because their growth rates are often slower. The DFW criterion is and "OR" so old-growth forests do not necessarily have to have trees of this diameter.                  ___ <b>Mature forests:</b> (west of the Cascade Crest) Stands where the largest trees are 80 – 200 years old OR have an average diameters (dbh) exceeding 21 inches (53 cm); crown cover may be less than 100%; decay, decadence, numbers of snags, and quantity of large downed material is generally less than that found in old-growth.                  YES = Category I                      NO = <u>X</u> not a forested wetland with special characteristics</p>	<p><b>Cat. I</b></p>
<p><b>SC5</b></p>	<p><b>Wetlands in Coastal Lagoons</b> (see p. 91)                  Does the wetland meet all of the following criteria of a wetland in a coastal lagoon?                  ___ The wetland lies in a depression adjacent to marine waters that is wholly or partially separated from marine waters by sandbanks, gravel banks, shingle, or, less frequently, rocks.                  ___ The lagoon in which the wetland is located contains surface water that is saline or brackish (&gt; 0.5 ppt) during most of the year in at least a portion of the lagoon (<i>needs to be measured near the bottom.</i>)                  YES = Go to SC 5.1                      NO <u>X</u> not a wetland in a coastal lagoon                  SC 5.1 Does the wetland meet all of the following three conditions?                  ___ The wetland is relatively undisturbed (has no diking, ditching, filling, cultivation, grazing) and has less than 20% cover of invasive plant species (see list of invasive species on p. 74).                  ___ At least 3/4 of the landward edge of the wetland has a 100 ft. buffer of shrub, forest, or un-grazed or un-mowed grassland.                  ___ The wetland is larger than 1/10 acre (4350 square ft.)                  YES = Category I                      NO = Category II</p>	<p><b>Cat. I</b>  <b>Cat. II</b></p>
<p><b>SC6</b></p>	<p><b>Interdunal Wetlands</b> (see p. 93)                  Is the wetland west of the 1889 line (also called the Western Boundary of Upland Ownership or WBUO)?                  YES = Go to SC 6.1                      NO <u>X</u> not an interdunal wetland for rating  <i>If you answer yes you will still need to rate the wetland based on its functions.</i>                  In practical terms that means the following geographic areas:                  • Long Beach Peninsula -- lands west of SR 103                  • Grayland-Westport -- lands west of SR 105                  • Ocean Shores-Copalis – lands west of SR 115 and SR 109                  SC 6.1 Is the wetland one acre or larger, or is it in a mosaic of wetlands that is one acre or larger?                  YES = Category II                      NO = go to SC 6.2                  SC 6.2 Is the wetland between 0.1 and 1 acre, or is it in a mosaic of wetlands that is between 0.1 and 1 acre?                  YES = Category III</p>	<p><b>Cat. II</b>  <b>Cat. III</b></p>
<p>◆</p>	<p><b>Category of wetland based on Special Characteristics</b>                  Choose the "highest" rating if wetland falls into several categories, and record on p. 1.                  If you answered NO for all types enter "Not Applicable" on p. 1</p>	<p><b>NA</b></p>

Comments:

Wetland name or number 19B

**WETLAND RATING FORM – WESTERN WASHINGTON**  
Version 2 – Updated July 2006 to increase accuracy and reproducibility among users  
Updated Oct. 2008 with the new WDFW definitions for priority habitats

Name of wetland (if known): 19B Date of site visit: 05-05-09 (rev: 03-11-14)

Rated by: Colin Worsley / Matt Maynard Trained by Ecology? Yes X No     Date of training: 11-2005 / 04-2006

SEC: 06 TOWNSHIP: 24N RANGE: 06E Is S/T/R in Appendix D? Yes     No X

Map of wetland unit: Figure                      Estimated size ~0.36 acre

**SUMMARY OF RATING**

Category based on FUNCTIONS provided by wetland: I     II     III     **X** IV    

Category I =	Score > 70
Category II =	Score 51 - 69
Category III =	Score 30 – 50
Category IV =	Score < 30

Score for Water Quality Functions	20
Score for Hydrologic Functions	4
Score for Habitat Functions	11
<b>TOTAL Score for Functions</b>	<b>35</b>

Category based on SPECIAL CHARACTERISTICS of Wetland I     II     Does not apply **X**

**Final Category** (choose the “highest” category from above”) **III**

**Summary of basic information about the wetland unit.**

Wetland Unit has Special Characteristics		Wetland HGM Class used for Rating	
<b>Estuarine</b>		<b>Depressional</b>	
<b>Natural Heritage Wetland</b>		<b>Riverine</b>	
<b>Bog</b>		<b>Lake-fringe</b>	<b>X</b>
<b>Mature Forest</b>		<b>Slope</b>	<b>(x)</b>
<b>Old Growth Forest</b>		<b>Flats</b>	
<b>Coastal Lagoon</b>		<b>Freshwater Tidal</b>	
<b>Interdunal</b>			
None of the above	<b>X</b>	Check if unit has multiple HGM classes present	<b>X</b>

**Does the wetland being rated meet any of the criteria below?** If you answer YES to any of the questions below you will need to protect the wetland according to the regulations regarding the special characteristics found in the wetland.

Check List for Wetlands that Need Additional Protection (in addition to the protection recommended for its category)	YES	NO
SP1. <i>Has the wetland unit been documented as a habitat for any Federally listed Threatened or Endangered <b>animal or plant</b> species (T/E species)?</i> For the purposes of this rating system, “documented” means the wetland is on the appropriate state or federal database.		X
SP2. <i>Has the wetland unit been documented as habitat for any State listed Threatened or Endangered <b>animal</b> species?</i> For the purposes of this rating system, “documented” means the wetland is on the appropriate state database. Note: Wetlands with State listed plant species are categorized as Category 1 Natural Heritage Wetlands (see p. 19 of data form).		X
SP3. <i>Does the wetland unit contain individuals of Priority species listed by the WDFW for the state?</i>		X
SP4. <i>Does the wetland unit have a local significance in addition to its functions?</i> For example, the wetland has been identified in the Shoreline Master Program, the Critical Areas Ordinance, or in a local management plan as having special significance.		X

To complete the next part of the data sheet you will need to determine the Hydrogeomorphic Class of the wetland being rated. Exhibit 16

SSDP2016-00415

001016

The hydrogeomorphic classification groups wetlands in to those that function in similar ways. This simplifies the questions needed to answer how well the wetland functions. The Hydrogeomorphic Class of a wetland can be determined using the key below. See p. 24 for more detailed instructions on classifying wetlands.  
Wetland Rating Form – Western Washington, Version 2 (7/06), updated with new WDFW definitions Oct. 2008 Page 1 of 8

### Classification of Vegetated Wetlands for Western Washington

If the hydrologic criteria listed in each question do not apply to the entire unit being rated, you probably have a unit with multiple HGM classes. In this case, identify which hydrologic criteria in questions 1-7 apply, and go to Question 8.

1. Are the water levels in the entire unit usually controlled by tides (i.e. except during floods)?  
NO – go to 2                      **YES – the wetland class is Tidal Fringe**  
 If yes, is the salinity of the water during periods of annual low flow below 0.5 ppt (parts per thousand)?  
**YES – Freshwater Tidal Fringe**                      **NO – Saltwater Tidal Fringe (Estuarine)**  
*If your wetland can be classified as a Freshwater Tidal Fringe use the forms for **Riverine** wetlands. If it is a Saltwater Tidal Fringe it is rated as an **Estuarine** wetland. Wetlands that were call estuarine in the first and second editions of the rating system are called Salt Water Tidal Fringe in the Hydrogeomorphic Classification. Estuarine wetlands were categorized separately in the earlier editions, and this separation is being kept in this revision. To maintain consistency between editions, the term “Estuarine” wetland is kept. Please note, however, that the characteristics that define Category I and II estuarine wetlands have changed (see p. \_\_\_\_).*

---

2. The entire wetland unit is flat and precipitation is only source (>90%) of water to it. Groundwater and surface water runoff are NOT sources of water to the unit.  
NO – go to 3                      **YES – The wetland class is Flats**  
 If your wetland can be classified as a “Flats” wetland, use the form for **Depressional** wetlands.

---

3. Does the entire wetland meet both of the following criteria?  
 \_\_\_\_ The vegetated part of the wetland is on the shores of a body of permanent open water (without any vegetation on the surface) where at least 20 acres (8ha) in size;  
 \_\_\_\_ At least 30% of the open water area is deeper than 6.6 (2 m)?  
NO – go to 4                      **YES – The wetland class is Lake-fringe (Lacustrine Fringe)**

---

4. Does the entire wetland meet all of the following criteria?  
 \_\_\_\_ The wetland is on a slope (*slope can be very gradual*).  
 \_\_\_\_ The water flows through the wetland in one direction (unidirectional) and usually comes from seeps. It may flow subsurface, as sheetflow, or in a swale without distinct banks.  
 \_\_\_\_ The water leaves the wetland **without being impounded**?  
 NOTE: *Surface water does not pond in these types of wetlands except occasionally in very small and shallow depressions or behind hummocks (depressions are usually <3 ft diameter and less than 1 foot deep).*  
NO – go to 5                      **YES – The wetland class is Slope**

---

5. Does the entire wetland meet all of the following criteria?  
 \_\_\_\_ The unit is in a valley or stream channel where it gets inundated by overbank flooding from that stream or river.  
 \_\_\_\_ The overbank flooding occurs at least once every two years.  
 NOTE: *The riverine unit can contain depressions that are filled with water when the river is not flooding..*  
NO – go to 6                      **YES – The wetland class is Riverine**

---

6. Is the entire wetland unit in a topographic depression in which water ponds, or is saturated to the surface, at some time of the year. This means that any outlet, if present is higher than the interior of the wetland.  
NO – go to 7                      **YES – The wetland class is Depressional**

---

7. Is the entire wetland located in a very flat area with no obvious depression and no overbank flooding. The unit does not pond surface water more than a few inches. The unit seems to be maintained by high groundwater in the area. The wetland may be ditched, but has no obvious natural outlet.  
No – go to 8                      **YES – The wetland class is Depressional**

---

8. Your wetland unit seems to be difficult to classify and probably contains several different HGM classes. For example, seeps at the base of a slope may grade into a riverine floodplain, or a small stream within a depressional wetland has a zone of flooding along its sides. **GO BACK AND IDENTIFY WHICH OF THE HYDROLOGIC REGIMES DESCRIBED IN QUESTIONS 1-7 APPLY TO DIFFERENT AREAS IN THE UNIT** (make a rough sketch to help you decide). Use the following table to identify the appropriate class to use for the rating system if you have several HGM classes present within your wetland. NOTE: Use this table only if the class that is recommended in the second column represents 10% or more of the total area of the wetland unit being rated. If the area of the class listed in column 2 is less than 10% of the unit, classify the wetland using the class that represents more than 90% of the total area.

HGM Classes within the wetland unit being rated	HGM Class to Use in Rating
Slope + Riverine	Riverine
Slope + Depressional	Depressional
Slope + Lake-fringe	Lake-fringe
Depressional + Riverine along stream within boundary	Depressional
Depressional + Lake-fringe	Depressional
Salt Water Tidal Fringe and any other class of freshwater wetland	Treat as ESTUARINE under wetlands with special characteristics

**Exhibit 16**  
**SSDP2016-00415**  
**001017**

If you are unable still to determine which of the above criteria apply to your wetland, or you have more than 2 HGM classes within a wetland boundary, classify the wetland as **Depressional** for the rating.

L Lake-fringe Wetlands		Points
WATER QUALITY FUNCTIONS – Indicators that the wetland unit functions to improve water quality.		(only 1 score per box)
<b>L 1</b>	<b>Does the wetland unit have the <u>potential</u> to improve water quality?</b> (see p.59)	
	L 1.1 Average width of vegetation along the lakeshore (use polygons of Cowardin classes): • Vegetation is more than 33 ft. (10m) wide ..... points = 6 • Vegetation is more than 16 ft.(5m) wide and < 33 ft ..... points = 3 • Vegetation is more than 6 ft. (2m) wide and < 16 ft ..... points = 1 • Vegetation is less than 6 ft. wide..... points = 0 <b>Map of Cowardin classes with widths marked</b>	Figure ____ 6
	L 1.2 Characteristics of the vegetation in the wetland: <i>Choose the appropriate description that results in the highest points, and do not include any open water in your estimate of coverage. The herbaceous plants can be either the dominant form or as an understory in a shrub or forest community. These are not Cowardin classes. Area of Cover is total cover in the unit, but it can be in patches. NOTE: Herbaceous does not include aquatic bed.</i> • Cover of herbaceous plants is > 90% of the vegetated area..... points = 6 • Cover of herbaceous plants is > 2/3 of the vegetated area..... points = 4 • Cover of herbaceous plants is > 1/3 of the vegetated area..... points = 3 • Other vegetation that is not aquatic bed or herbaceous covers > 2/3 of the unit ..... points = 3 • Other vegetation that is not aquatic bed in > 1/3 vegetated area ..... points = 1 • Aquatic bed cover and open water > 2/3 of the unit..... points = 0 <b>Map with polygons of different vegetation types</b>	Figure ____ 4
<i>Add the points in the boxes above</i>		10
<b>L 2</b>	<b>Does the wetland have the <u>opportunity</u> to improve water quality?</b>	(see p.61)
	Answer YES if you know or believe there are pollutants in the lake water, or polluted surface water flowing through the unit to the lake. <i>Note which of the following conditions provide the sources of pollutants. A unit may have pollutants coming from several sources, but any single source would qualify as opportunity.</i> ___ Wetland is along the shores of a lake or reservoir that does not meet water quality standards ___ Grazing in the wetland or within 150 ft ___ Polluted water discharges to wetland along upland edge ___ Tilled fields or orchards within 150 ft. of wetland <input checked="" type="checkbox"/> Residential or urban areas are within 150 ft. of wetland ___ Parks with grassy areas that are maintained, ballfields, golf courses (all within 150 ft. of lake shore) <input checked="" type="checkbox"/> Power boats with gasoline or diesel engines use the lake ___ Other _____ YES multiplier is 2 NO multiplier is 1	Multiplier X2
<b>◆</b>	<b>TOTAL – Water Quality Functions</b> Multiply the score from L1 by L2; then <i>add score to table on p. 1</i>	20
HYDROLOGIC FUNCTIONS – Indicators that wetland functions to reduce shoreline erosion.		
<b>L 3</b>	<b>Does the wetland have the <u>potential</u> to reduce shoreline erosion?</b>	(see p.62)
	L 3 Average width and characteristics of vegetation along the lakeshore ( <i>do not include aquatic bed</i> ): ( <i>choose the highest scoring description that matches conditions in the wetland</i> ) • 3/4 of distance is shrubs or forest at least 33 ft. (10m) wide ..... points = 6 • 3/4 of distance is shrubs or forest at least 6 ft. (2m) wide. .... points = 4 • 1/4 of distance is shrubs or forest at least 33 ft. (10m) wide. .... points = 4 • Vegetation is at least 6 ft. (2m) wide (any type except aquatic bed)..... points = 2 • Vegetation is less than 6 ft. (2m) wide (any type except aquatic bed) ..... points = 0 <b>Aerial photo or map with Cowardin vegetation classes</b>	Figure ____ 2
<i>Record the points in the boxes above</i>		2
<b>L 4</b>	<b>Does the wetland have the <u>opportunity</u> to reduce erosion?</b>	(see p. 64)
	Are there features along the shore that will be impacted if the shoreline erodes? <i>Note which of the following conditions apply.</i> <input checked="" type="checkbox"/> There are human structures and activities along the upland edge of the wetland (buildings, fields) that can be damaged by erosion. ___ There are undisturbed natural resources along the upland edge of the wetland (e.g. mature forests, other wetlands) that can be damaged by shoreline erosion. ___ Other _____ YES multiplier is 2 NO multiplier is 1	Multiplier X2
<b>◆</b>	<b>TOTAL – Hydrologic Functions</b> Multiply the score from L3 by L4; then <i>add score to table on p. 1</i>	4

Comments: Majority of herbaceous vegetation is maintained lawn.





These questions apply to wetlands of all HGM classes.		Points
HABITAT FUNCTIONS – Indicators that wetland functions to provide important habitat.		(only 1 score per box)
<b>H 1</b>	<b>Does the wetland have the potential to provide habitat for many species?</b>	
H 1.1	<p><b>Vegetation structure</b> (see P. 72):                      Check the types of vegetation classes present (as defined by Cowardin) – Size threshold for each class is 1/4 acre or more than 10% of the area if unit is smaller than 2.5 acres.</p> <p><input type="checkbox"/> Aquatic Bed  <input checked="" type="checkbox"/> Emergent plants  <input checked="" type="checkbox"/> Scrub/shrub (areas where shrubs have &gt; 30% cover)  <input type="checkbox"/> Forested (areas where trees have &gt; 30% cover)</p> <p>If the unit has a forested class check if:  <input type="checkbox"/> The forested class has 3 out of 5 strata (canopy, sub-canopy, shrubs, herbaceous, moss/ground-cover) that each cover 20% within the forested polygon.                      Add the number of vegetation types that qualify. If you have:</p> <p style="text-align: right;"><b>Map of Cowardin vegetation classes</b></p> <p>4 structures or more..... points = 4                      3 structures ..... points = 2                      2 structures ..... points = 1                      1 structure ..... points = 0</p>	Figure ____  1
H 1.2	<p><b>Hydroperiods</b> (see p.73):                      Check the types of water regimes (hydroperiods) present within the wetland. The water regime has to cover more than 10% of the wetland or 1/4 acre to count (see text for descriptions of hydroperiods).</p> <p><input type="checkbox"/> Permanently flooded or inundated  <input type="checkbox"/> Seasonally flooded or inundated  <input type="checkbox"/> Occasionally flooded or inundated  <input type="checkbox"/> Saturated only  <input type="checkbox"/> Permanently flowing stream or river in, or adjacent to, the wetland  <input type="checkbox"/> Seasonally flowing stream in, or adjacent to, the wetland  <input checked="" type="checkbox"/> Lake-fringe wetland ..... = 2 points  <input type="checkbox"/> Freshwater tidal wetland ..... = 2 points</p> <p style="text-align: right;"><b>Map of hydroperiods</b></p> <p>4 or more types present points = 3                      3 or more types present ..... points = 2                      2 types present ..... points = 1                      1 type present ..... points = 0</p>	Figure ____  2
H 1.3	<p><b>Richness of Plant Species</b> (see p. 75):                      Count the number of plant species in the wetland that cover at least 10 ft<sup>2</sup> (different patches of the same species can be combined to meet the size threshold)                      You do not have to name the species. Do not include Eurasian Milfoil, reed canarygrass, purple loosestrife, Canadian Thistle.</p> <p>If you counted: &gt; 19 species ..... points = 2                      5 – 19 species ..... points = 1                      &lt; 5 species ..... points = 0</p> <p>List species below if you want to:                      _____                      _____                      _____</p>	1
H 1.4	<p><b>Interspersion of Habitats</b> (see p. 76):                      Decided from the diagrams below whether interspersion between Cowardin vegetation (described in H1.1), or the classes and unvegetated areas (can include open water or mudflats) is high, medium, low, or none.</p> <div style="display: flex; justify-content: space-around;"> <div style="text-align: center;">  <p>None = 0 points</p> </div> <div style="text-align: center;">  <p>Low = 1 point</p> </div> <div style="text-align: center;">  <p>Moderate = 2 points</p> </div> <div style="text-align: center;">  <p>High = 3 points</p> </div> </div> <p style="text-align: center;">[riparian braided channels]</p> <p>Note: If you have 4 or more classes or 3 vegetation classes and open water, the rating is always “high”.</p> <p style="text-align: right;"><b>Use map of Cowardin classes.</b></p>	Figure ____  1
H 1.5	<p><b>Special Habitat Features</b> (see p. 77):                      Check the habitat features that are present in the wetland. The number of checks is the number of points you put into the next column.</p> <p><input type="checkbox"/> Large, downed, woody debris within the wetland (&gt; 4 in. diameter and 6 ft. long)  <input type="checkbox"/> Standing snags (diameter at the bottom &gt; 4 inches) in the wetland  <input type="checkbox"/> Undercut banks are present for at least 6.6 ft. (2m) and/or overhanging vegetation extends at least 3.3 ft. (1m) over a stream (or ditch) in, or contiguous with the unit, for at least 33 ft. (10m)  <input type="checkbox"/> Stable steep banks of fine material that might be used by beaver or muskrat for denning (&gt; 30 degree slope) OR signs of recent beaver activity are present (cut shrubs or trees that have not yet turned grey/brown)  <input type="checkbox"/> At least 1/4 acre of thin-stemmed persistent vegetation or woody branches are present in areas that are permanently or seasonally inundated (structures for egg-laying by amphibians)  <input type="checkbox"/> Invasive plants cover less than 25% of the wetland area in each stratum of plants</p> <p>NOTE: The 20% stated in early printings of the manual on page 78 is an error.</p>	0
<b>H 1 TOTAL Score</b> – potential for providing habitat		5

Exhibit 16  
 SSSP 2016-00215  
 001019



H 2	Does the wetland have the <u>opportunity</u> to provide habitat for many species?	(only 1 score per box)
	<p>H 2.1 <u>Buffers</u> (see P. 80): Choose the description that best represents condition of buffer of wetland unit. The highest scoring criterion that applies to the wetland is to be used in the rating. See text for definition of "undisturbed".</p> <p>___ 100m (330 ft) of relatively undisturbed vegetated areas, rocky areas, or open water &gt; 95% of circumference. No structures are within the undisturbed part of buffer (relatively undisturbed also means no grazing, no landscaping, no daily human use)..... <b>points = 5</b></p> <p>___ 100m (330 ft) of relatively undisturbed vegetated areas, rocky areas, or open water &gt; 50% circumference..... <b>points = 4</b></p> <p>___ 50m (170 ft) of relatively undisturbed vegetated areas, rocky areas, or open water &gt; 95% circumference..... <b>points = 4</b></p> <p>___ 100m (330 ft) of relatively undisturbed vegetated areas, rocky areas, or open water &gt; 25% circumference..... <b>points = 3</b></p> <p>___ 50m (170 ft) of relatively undisturbed vegetated areas, rocky areas, or open water for &gt; 50% circumference..... <b>points = 3</b></p> <p><b>If buffer does not meet any of the criteria above:</b></p> <p>___ No paved areas (except paved trails) or buildings within 25m (80 ft) of wetland &gt; 95% circumference. Light to moderate grazing or lawns are OK..... <b>points = 2</b></p> <p>___ No paved areas of buildings within 50m of wetland for &gt; 50% circumference. Light to moderate grazing or lawns are OK..... <b>points = 2</b></p> <p>___ Heavy grazing in buffer..... <b>points = 1</b></p> <p>___ Vegetated buffers are &lt; 2m wide (6.6 ft) for more than 95% circumference (e.g. tilled fields, paving, basalt bedrock extend to edge of wetland)..... <b>points = 0</b></p> <p><b>X</b> <b>Buffer does not meet any of the criteria above..... points = 1</b></p> <p style="text-align: right;"><b>Arial photo showing buffers</b></p>	<p>Figure ____</p> <p style="text-align: center;">1</p>
	<p>H 2.2 <u>Corridors and Connections</u> (see p. 81)</p> <p>H 2.2.1 Is the wetland part of a relatively undisturbed and unbroken vegetated corridor (either riparian or upland) that is at least 150 ft. wide, has at least a 30% cover of shrubs, forest or native undisturbed prairie, that connects to estuaries, other wetlands or undisturbed uplands that are at least 250 acres in size? (<i>Dams in riparian corridors, heavily used gravel roads, paved roads, are considered breaks in the corridor.</i>)</p> <p style="padding-left: 40px;">YES = <b>4 points</b> (go to H 2.3) <span style="margin-left: 100px;"><b>NO = go to H 2.2.2</b></span></p> <p>H. 2.2.2 Is the wetland part of a relatively undisturbed and unbroken vegetated corridor (either riparian or upland) that is at least 50 ft. wide, has at least 30% cover of shrubs or forest, and connects to estuaries, other wetlands or undisturbed uplands that are at least 25 acres in size? <b>OR a Lake-fringe wetland, if it does not have an undisturbed corridor as in the question above?</b></p> <p style="padding-left: 40px;"><b>YES = 2 points</b> (go to H 2.3) <span style="margin-left: 100px;">NO = go to H 2.2.3</span></p> <p>H. 2.2.3 Is the wetland:</p> <ul style="list-style-type: none"> <li>• Within 5 mi (8km) of a brackish or salt water estuary OR</li> <li>• Within 3 miles of a large field or pasture (&gt; 40 acres) OR</li> <li>• Within 1 mile of a lake greater than 20 acres?</li> </ul> <p style="padding-left: 40px;">YES = 1 point NO = 0 points</p>	<p style="text-align: center;">2</p>

Comments:

	<p>H 2.3 <u>Near or adjacent to other priority habitats listed by WDFW</u> (see p. 82): (see new and complete descriptions of WDFW priority habitats, and the counties in which they can be found, in the PHS report <a href="http://wdfw.wa.gov/hab/phslist.htm">http://wdfw.wa.gov/hab/phslist.htm</a>)</p> <p>Which of the following priority habitats are within 330 ft. (100m) of the wetland unit?  <i>NOTE: the connections do not have to be relatively undisturbed.</i></p> <p><input type="checkbox"/> <b>Aspen Stands:</b> Pure or mixed stands of aspen greater than 0.4 ha (1 acre).</p> <p><input type="checkbox"/> <b>Biodiversity Areas and Corridors:</b> Areas of habitat that are relatively important to various species of native fish and wildlife (full descriptions in WDFW PHS report p. 152).</p> <p><input type="checkbox"/> <b>Herbaceous Balds:</b> Variable size patches of grass and forbs on shallow soils over bedrock.</p> <p><input type="checkbox"/> <b>Old-growth/Mature forests:</b> (Old-growth west of Cascade crest) Stands of at least 2 tree species, forming a multi-layered canopy with occasional small openings; with at least 20 trees/ha (8 trees/acre) &gt; 81 cm (32 in) dbh or &gt; 200 years of age. (Mature forests) Stands with average diameters exceeding 53 cm (21 in) dbh; crown cover may be less than 100%; decay, decadence, numbers of snags, and quantity of large downed material is generally less than that found in old-growth; 80 - 200 years old west of the Cascade crest.</p> <p><input type="checkbox"/> <b>Oregon white Oak:</b> Woodlands Stands of pure oak or oak/conifer associations where canopy coverage of the oak component is important (full descriptions in WDFW PHS report p. 158).</p> <p><input type="checkbox"/> <b>Riparian:</b> The area adjacent to aquatic systems with flowing water that contains elements of both aquatic and terrestrial ecosystems which mutually influence each other.</p> <p><input type="checkbox"/> <b>Westside Prairies:</b> Herbaceous, non-forested plant communities that can either take the form of a dry prairie or a wet prairie (full descriptions in WDFW PHS report p. 161).</p> <p><input type="checkbox"/> <b>Instream:</b> The combination of physical, biological, and chemical processes and conditions that interact to provide functional life history requirements for instream fish and wildlife resources.</p> <p><input type="checkbox"/> <b>Nearshore:</b> Relatively undisturbed nearshore habitats. These include Coastal Nearshore, Open Coast Nearshore, and Puget Sound Nearshore. (full descriptions of habitats and the definition of relatively undisturbed are in WDFW report: pp. 167-169 and glossary in Appendix A).</p> <p><input type="checkbox"/> <b>Caves:</b> A naturally occurring cavity, recess, void, or system of interconnected passages under the earth in soils, rock, ice, or other geological formations and is large enough to contain a human.</p> <p><input type="checkbox"/> <b>Cliffs:</b> Greater than 7.6 m (25 ft) high and occurring below 5000 ft.</p> <p><input type="checkbox"/> <b>Talus:</b> Homogenous areas of rock rubble ranging in average size 0.15 - 2.0 m (0.5 - 6.5 ft), composed of basalt, andesite, and/or sedimentary rock, including riprap slides and mine tailings. May be associated with cliffs.</p> <p><input type="checkbox"/> <b>Snags and Logs:</b> Trees are considered snags if they are dead or dying and exhibit sufficient decay characteristics to enable cavity excavation/use by wildlife. Priority snags have a diameter at breast height of &gt; 51 cm (20 in) in western Washington and are &gt; 2 m (6.5 ft) in height. Priority logs are &gt; 30 cm (12 in) in diameter at the largest end, and &gt; 6 m (20 ft) long.</p> <p>If wetland has <b>3 or more</b> priority habitats = <b>4 points</b>                  If wetland has <b>2</b> priority habitats = <b>3 points</b>                  If wetland has <b>1</b> priority habitat = <b>1 point</b>                      <b>No habitats = 0 points</b></p> <p>Note: All vegetated wetlands are by definition a priority habitat but are not included in this list. Nearby wetlands are addressed in question H 2.4)</p>	0
	<p>H 2.4 <u>Wetland Landscape:</u> Choose the <b>one</b> description of the landscape around the wetland that best fits (see p. 84)</p> <ul style="list-style-type: none"> <li>• There are at least 3 other wetlands within 1/2 mile, and the connections between them are relatively undisturbed (light grazing between wetlands OK, as is lake shore with some boating, but connections should NOT be bisected by paved roads, fill, fields, or other development.....points = 5</li> <li>• The wetland is Lake-fringe on a lake with little disturbance and there are 3 other lake-fringe wetlands within 1/2 mile .....points = 5</li> <li>• <b>There are at least 3 other wetlands within 1/2 mile, BUT the connections between them are disturbed.....points = 3</b></li> <li>• The wetland fringe on a lake <b>with</b> disturbance and there are 3 other lake-fringe wetlands within 1/2 mile .....points = 3</li> <li>• There is at least 1 wetland within 1/2 mile .....points = 2</li> <li>• There are no wetlands within 1/2 mile.....points = 0</li> </ul>	3
<b>H 2 TOTAL Score – opportunity for providing habitat</b> <i>Add the scores from H2.1, H2.2, H2.3, H2.4</i>		6
<i>TOTAL for H 1 from page 8</i>		5
◆	<b>Total Score for Habitat Functions</b> Add the points for H 1 and H 2; then <b>record the result on p. 1</b>	11

Comments:

**CATEGORIZATION BASED ON SPECIAL CHARACTERISTICS**

**Please determine if the wetland meets the attributes described below and circle the appropriate answers and Category.**

<b>Wetland Type</b> – Check off any criteria that apply to the wetland. Circle the Category when the appropriate criteria are met.		
<b>SC1</b>	<b>Estuarine wetlands?</b> ( <i>see p.86</i> ) Does the wetland unit meet the following criteria for Estuarine wetlands? <input type="checkbox"/> The dominant water regime is tidal, <input type="checkbox"/> Vegetated, and <input type="checkbox"/> With a salinity greater than 0.5 ppt. YES = Go to SC 1.1                                      NO = <u>X</u>	
	SC 1.1 Is the wetland unit within a National Wildlife Refuge, National Park, National Estuary Reserve, Natural Area Preserve, State Park or Educational, Environmental, or Scientific Reserve designated under WAC 332-30-151?    YES = Category I                                      NO = go to SC 1.2	<b>Cat. I</b>
	SC 1.2 Is the wetland at least 1 acre in size and meets at least two of the following conditions? YES = Category I                                      NO = Category II <input type="checkbox"/> The wetland is relatively undisturbed (has no diking, ditching, filling, cultivation, grazing, and has less than 10% cover of non-native plant species. If the non-native <i>Spartina</i> spp., are only species that cover more than 10% of the wetland, then the wetland should be given a dual rating (I/II). The area of <i>Spartina</i> would be rated a Category II while the relatively undisturbed upper marsh with native species would be a Category I. Do not, however, exclude the area of <i>Spartina</i> in determining the size threshold of 1 acre. <input type="checkbox"/> At least 3/4 of the landward edge of the wetland has a 100 ft. buffer of shrub, forest, or un-grazed or un-mowed grassland <input type="checkbox"/> The wetland has at least 2 of the following features: tidal channels, depressions with open water, or contiguous freshwater wetlands.	<b>Cat. I</b>   <b>Cat. II</b>   <b>Dual Rating I/II</b>
<b>SC2</b>	<b>Natural Heritage Wetlands</b> ( <i>see p. 87</i> ) Natural Heritage wetlands have been identified by the Washington Natural Heritage Program/DNR as either high quality undisturbed wetlands or wetlands that support state Threatened, Endangered, or Sensitive plant species. SC 2.1 Is the wetland being rated in a Section/Township/Range that contains a natural heritage wetland? ( <i>This question is used to screen out most sites before you need to contact WNHP/DNR.</i> ) S/T/R information from Appendix D _____ or accessed from WNHP/DNR web site _____ YES _____ Contact WNHP/DNR (see p. 79) and go to SC 2.2                                      NO = <u>X</u> SC 2.2 Has DNR identified the wetland as a high quality undisturbed wetland or as a site with state threatened or endangered plant species? YES = Category 1                                      NO = _____ not a Heritage Wetland	<b>Cat I</b>
<b>SC3</b>	<b>Bogs</b> ( <i>see p. 87</i> ) Does the wetland ( <b>or any part of the unit</b> ) meet both the criteria for soils and vegetation in bogs? Use the key below to identify if the wetland is a bog. <b>If you answer yes you will still need to rate the wetland based on its function.</b> 1. Does the unit have organic soil horizons (i.e. layers of organic soil), either peats or mucks, that compose 16 inches or more of the first 32 inches of soil profile? (See Appendix B for a field key to identify organic soils)?                                      YES = go to question 3                                      NO = go to question 2 2. Does the wetland have organic soils, either peats or mucks that are less than 16 inches deep over bedrock, or an impermeable hardpan such as clay or volcanic ash, or that are floating on a lake or pond?                                      YES = go to question 3                                      NO = is not a bog for purpose of rating 3. Does the unit have more than 70% cover of mosses at ground level, AND other plants, if present, consist of the “bog” species listed in Table 3 as a significant component of the vegetation (more than 30% of the total shrub and herbaceous cover consists of species in Table 3)? YES = Is a bog for purpose of rating                                      NO = go to question 4 NOTE: If you are uncertain about the extent of mosses in the understory you may substitute that criterion by measuring the pH of the water that seeps into a hole dug at least 16” deep. If the pH is less than 5.0 and the “bog” plant species in Table 3 are present, the wetland is a bog. 4. Is the unit forested (> 30% cover) with sitka spruce, subalpine fir, western red cedar, western hemlock, lodgepole pine, quaking aspen, Englemann’s spruce, or western white pine. WITH any of the species (or combination of species) on the bog species plant list in Table 3 as a significant component of the ground cover (> 30% coverage of the total shrub/herbaceous cover)? YES = Category I                                      NO = Is not a bog for purpose of rating	<b>Cat. I</b>

Exhibit 16  
 SSSDP2016-00415  
 001022

<b>SC4</b>	<p><b>Forested Wetlands</b> (<i>see p. 90</i>)</p> <p>Does the wetland have at least 1 acre of forest that meet one of these criteria for the Department of Fish and Wildlife's forests as priority habitats? <i>If you answer yes you will still need to rate the wetland based on its function.</i></p> <p>___ <b>Old-growth forests:</b> (west of Cascade Crest) Stands of at least two three species forming a multi-layered canopy with occasional small openings; with at least 8 trees/acre (20 trees/hectare) that are at least 200 years of age OR have a diameter at breast height (dbh) of 32 inches (81 cm or more).</p> <p>NOTE: The criterion for dbh is based on measurements for upland forests. Two-hundred year old trees in wetlands will often have a smaller dbh because their growth rates are often slower. The DFW criterion is and "OR" so old-growth forests do not necessarily have to have trees of this diameter.</p> <p>___ <b>Mature forests:</b> (west of the Cascade Crest) Stands where the largest trees are 80 – 200 years old OR have an average diameters (dbh) exceeding 21 inches (53 cm); crown cover may be less than 100%; decay, decadence, numbers of snags, and quantity of large downed material is generally less than that found in old-growth.</p> <p>YES = Category I                      NO = <u>X</u> not a forested wetland with special characteristics</p>	<b>Cat. I</b>
<b>SC5</b>	<p><b>Wetlands in Coastal Lagoons</b> (<i>see p. 91</i>)</p> <p>Does the wetland meet all of the following criteria of a wetland in a coastal lagoon?</p> <p>___ The wetland lies in a depression adjacent to marine waters that is wholly or partially separated from marine waters by sandbanks, gravel banks, shingle, or, less frequently, rocks.</p> <p>___ The lagoon in which the wetland is located contains surface water that is saline or brackish (&gt; 0.5 ppt) during most of the year in at least a portion of the lagoon (<i>needs to be measured near the bottom.</i>)</p> <p>YES = Go to SC 5.1                      NO <u>X</u> not a wetland in a coastal lagoon</p> <p>SC 5.1 Does the wetland meet all of the following three conditions?</p> <p>___ The wetland is relatively undisturbed (has no diking, ditching, filling, cultivation, grazing) and has less than 20% cover of invasive plant species (see list of invasive species on p. 74).</p> <p>___ At least 3/4 of the landward edge of the wetland has a 100 ft. buffer of shrub, forest, or un-grazed or un-mowed grassland.</p> <p>___ The wetland is larger than 1/10 acre (4350 square ft.)</p> <p>YES = Category I                      NO = Category II</p>	<b>Cat. I</b> <b>Cat. II</b>
<b>SC6</b>	<p><b>Interdunal Wetlands</b> (<i>see p. 93</i>)</p> <p>Is the wetland west of the 1889 line (also called the Western Boundary of Upland Ownership or WBUO)?</p> <p>YES = Go to SC 6.1                      NO <u>X</u> not an interdunal wetland for rating</p> <p><i>If you answer yes you will still need to rate the wetland based on its functions.</i></p> <p>In practical terms that means the following geographic areas:</p> <ul style="list-style-type: none"> <li>• Long Beach Peninsula -- lands west of SR 103</li> <li>• Grayland-Westport -- lands west of SR 105</li> <li>• Ocean Shores-Copalis – lands west of SR 115 and SR 109</li> </ul> <p>SC 6.1 Is the wetland one acre or larger, or is it in a mosaic of wetlands that is one acre or larger?</p> <p>YES = Category II                      NO = go to SC 6.2</p> <p>SC 6.2 Is the wetland between 0.1 and 1 acre, or is it in a mosaic of wetlands that is between 0.1 and 1 acre?</p> <p>YES = Category III</p>	<b>Cat. II</b> <b>Cat. III</b>
◆	<p><b>Category of wetland based on Special Characteristics</b></p> <p><i>Choose the "highest" rating if wetland falls into several categories, and record on p. 1.</i></p> <p>If you answered NO for all types enter "Not Applicable" on p. 1</p>	<b>NA</b>

Comments:

Wetland name or number 20A

**WETLAND RATING FORM – WESTERN WASHINGTON**  
Version 2 – Updated July 2006 to increase accuracy and reproducibility among users  
Updated Oct. 2008 with the new WDFW definitions for priority habitats

Name of wetland (if known): 20A Date of site visit: 09-12-13

Rated by: Colin Worsley / Matt Maynard Trained by Ecology? Yes X No      Date of training: 11-2005 / 04-2006

SEC: 06 TOWNSHIP: 24N RANGE: 06E Is S/T/R in Appendix D? Yes      No X

Map of wetland unit: Figure      Estimated size 0.05 acre

**SUMMARY OF RATING**

Category based on FUNCTIONS provided by wetland: I      II      III X IV     

Category I =	Score > 70
Category II =	Score 51 - 69
Category III =	Score 30 – 50
Category IV =	Score < 30

Score for Water Quality Functions	18
Score for Hydrologic Functions	16
Score for Habitat Functions	11
<b>TOTAL Score for Functions</b>	<b>45</b>

Category based on SPECIAL CHARACTERISTICS of Wetland I      II      Does not apply X

**Final Category** (choose the “highest” category from above”) **III**

**Summary of basic information about the wetland unit.**

Wetland Unit has Special Characteristics		Wetland HGM Class used for Rating	
<b>Estuarine</b>		<b>Depressional</b>	<b>X</b>
<b>Natural Heritage Wetland</b>		<b>Riverine</b>	
<b>Bog</b>		<b>Lake-fringe</b>	
<b>Mature Forest</b>		<b>Slope</b>	(x)
<b>Old Growth Forest</b>		<b>Flats</b>	
<b>Coastal Lagoon</b>		<b>Freshwater Tidal</b>	
<b>Interdunal</b>			
None of the above	X	Check if unit has multiple HGM classes present	<b>X</b>

**Does the wetland being rated meet any of the criteria below?** If you answer YES to any of the questions below you will need to protect the wetland according to the regulations regarding the special characteristics found in the wetland.

Check List for Wetlands that Need Additional Protection (in addition to the protection recommended for its category)	YES	NO
SP1. <i>Has the wetland unit been documented as a habitat for any Federally listed Threatened or Endangered <b>animal or plant</b> species (T/E species)?</i> For the purposes of this rating system, “documented” means the wetland is on the appropriate state or federal database.		X
SP2. <i>Has the wetland unit been documented as habitat for any State listed Threatened or Endangered <b>animal</b> species?</i> For the purposes of this rating system, “documented” means the wetland is on the appropriate state database. Note: Wetlands with State listed plant species are categorized as Category 1 Natural Heritage Wetlands (see p. 19 of data form).		X
SP3. <i>Does the wetland unit contain individuals of Priority species listed by the WDFW for the state?</i>		X
SP4. <i>Does the wetland unit have a local significance in addition to its functions?</i> For example, the wetland has been identified in the Shoreline Master Program, the Critical Areas Ordinance, or in a local management plan as having special significance.		X

To complete the next part of the data sheet you will need to determine the Hydrogeomorphic Class of the wetland being rated.

Exhibit 16  
SSDP2016-00415  
001024

### Classification of Vegetated Wetlands for Western Washington

If the hydrologic criteria listed in each question do not apply to the entire unit being rated, you probably have a unit with multiple HGM classes. In this case, identify which hydrologic criteria in questions 1-7 apply, and go to Question 8.

1. Are the water levels in the entire unit usually controlled by tides (i.e. except during floods)?  
NO – go to 2                      **YES – the wetland class is Tidal Fringe**  
 If yes, is the salinity of the water during periods of annual low flow below 0.5 ppt (parts per thousand)?  
**YES – Freshwater Tidal Fringe**                      **NO – Saltwater Tidal Fringe (Estuarine)**  
*If your wetland can be classified as a Freshwater Tidal Fringe use the forms for Riverine wetlands. If it is a Saltwater Tidal Fringe it is rated as an Estuarine wetland. Wetlands that were call estuarine in the first and second editions of the rating system are called Salt Water Tidal Fringe in the Hydrogeomorphic Classification. Estuarine wetlands were categorized separately in the earlier editions, and this separation is being kept in this revision. To maintain consistency between editions, the term “Estuarine” wetland is kept. Please note, however, that the characteristics that define Category I and II estuarine wetlands have changed (see p. \_\_\_\_\_).*

---

2. The entire wetland unit is flat and precipitation is only source (>90%) of water to it. Groundwater and surface water runoff are NOT sources of water to the unit.  
NO – go to 3                      **YES – The wetland class is Flats**  
 If your wetland can be classified as a “Flats” wetland, use the form for **Depressional** wetlands.

---

3. Does the entire wetland meet both of the following criteria?  
 \_\_\_\_\_ The vegetated part of the wetland is on the shores of a body of permanent open water (without any vegetation on the surface) where at least 20 acres (8ha) in size;  
 \_\_\_\_\_ At least 30% of the open water area is deeper than 6.6 (2 m)?  
NO – go to 4                      **YES – The wetland class is Lake-fringe (Lacustrine Fringe)**

---

4. Does the entire wetland meet all of the following criteria?  
 \_\_\_\_\_ The wetland is on a slope (*slope can be very gradual*).  
 \_\_\_\_\_ The water flows through the wetland in one direction (unidirectional) and usually comes from seeps. It may flow subsurface, as sheetflow, or in a swale without distinct banks.  
 \_\_\_\_\_ The water leaves the wetland **without being impounded**?  
 NOTE: *Surface water does not pond in these types of wetlands except occasionally in very small and shallow depressions or behind hummocks (depressions are usually <3 ft diameter and less than 1 foot deep).*  
NO – go to 5                      **YES – The wetland class is Slope**

---

5. Does the entire wetland meet all of the following criteria?  
 \_\_\_\_\_ The unit is in a valley or stream channel where it gets inundated by overbank flooding from that stream or river.  
 \_\_\_\_\_ The overbank flooding occurs at least once every two years.  
 NOTE: *The riverine unit can contain depressions that are filled with water when the river is not flooding..*  
NO – go to 6                      **YES – The wetland class is Riverine**

---

6. Is the entire wetland unit in a topographic depression in which water ponds, or is saturated to the surface, at some time of the year. This means that any outlet, if present is higher than the interior of the wetland.  
NO – go to 7                      **YES – The wetland class is Depressional**

---

7. Is the entire wetland located in a very flat area with no obvious depression and no overbank flooding. The unit does not pond surface water more than a few inches. The unit seems to be maintained by high groundwater in the area. The wetland may be ditched, but has no obvious natural outlet.  
No – go to 8                      **YES – The wetland class is Depressional**

---

8. Your wetland unit seems to be difficult to classify and probably contains several different HGM classes. For example, seeps at the base of a slope may grade into a riverine floodplain, or a small stream within a depressional wetland has a zone of flooding along its sides. **GO BACK AND IDENTIFY WHICH OF THE HYDROLOGIC REGIMES DESCRIBED IN QUESTIONS 1-7 APPLY TO DIFFERENT AREAS IN THE UNIT** (make a rough sketch to help you decide). Use the following table to identify the appropriate class to use for the rating system if you have several HGM classes present within your wetland. NOTE: Use this table only if the class that is recommended in the second column represents 10% or more of the total area of the wetland unit being rated. If the area of the class listed in column 2 is less than 10% of the unit, classify the wetland using the class that represents more than 90% of the total area.

HGM Classes within the wetland unit being rated	HGM Class to Use in Rating
Slope + Riverine	Riverine
Slope + Depressional	Depressional
Slope + Lake-fringe	Lake-fringe
Depressional + Riverine along stream within boundary	Depressional
Depressional + Lake-fringe	Depressional
Salt Water Tidal Fringe and any other class of freshwater wetland	Treat as ESTUARINE under wetlands with special characteristics

**Exhibit 16**  
**SSDP2016-00415**  
**001025**

If you are unable still to determine which of the above criteria apply to your wetland, or you have more than 2 HGM classes within a wetland boundary, classify the wetland as **Depressional** for the rating.

<b>D Depressional and Flat Wetlands</b>		<b>Points</b>
WATER QUALITY FUNCTIONS – Indicators that wetland functions to improve water quality.		(only 1 score per box) <i>(see p.38)</i>
<b>D 1</b>	<b>Does the wetland have the <u>potential</u> to improve water quality?</b>	
D 1.1	Characteristics of surface water flows out of the wetland: <ul style="list-style-type: none"> <li>• Unit is a depression with no surface water leaving it (no outlet)..... points = 3</li> <li>• <b>Unit has an intermittently flowing, OR highly constricted, permanently flowing outlet..... points = 2</b></li> <li>• Unit has an unstricted, or slightly constricted, surface outlet (<i>permanently flowing</i>) ..... points = 1</li> <li>• Unit is a “flat” depression (Q.7 on key), or in the Flats class, with permanent surface outflow <b>and no obvious natural outlet</b> and/or outlet is a man-made ditch..... points = 1 <i>(If ditch is not permanently flowing treat unit as “intermittently flowing”)</i> <b>Provide photo or drawing</b></li> </ul>	Figure ____ 2
D 1.2	The soil 2 inches below the surface (or duff layer) is clay or organic ( <i>use NRCS definitions</i> ) YES points = 4 NO points = 0	0
D 1.3	Characteristics of persistent vegetation (emergent, shrub, and/or forest Cowardin class): <ul style="list-style-type: none"> <li>• <b>Wetland has persistent, ungrazed vegetation &gt;= 95% of area..... points = 5</b></li> <li>• Wetland has persistent, ungrazed vegetation &gt;= 1/2 of area..... points = 3</li> <li>• Wetland has persistent, ungrazed vegetation &gt;= 1/10 of area..... points = 1</li> <li>• Wetland has persistent, ungrazed vegetation &lt; 1/10 of area..... points = 0</li> </ul> <b>Map of Cowardin vegetation classes</b>	Figure ____ 5
D 1.4	Characteristics of seasonal ponding or inundation: <i>This is the area of the wetland that is ponded for at least 2 months, but dries out sometime during the year. Do not count the area that is permanently ponded. Estimate area as the average condition 5 out of 10 years.</i> <ul style="list-style-type: none"> <li>• Area seasonally ponded is &gt; 1/2 total area of wetland ..... points = 4</li> <li>• <b>Area seasonally ponded is &gt; 1/4 total area of wetland..... points = 2</b></li> <li>• Area seasonally ponded is &lt; 1/4 total area of wetland ..... points = 0</li> </ul> <b>Map of Hydroperiods</b>	Figure ____ 2
<b>Total for D 1</b>		<i>Add the points in the boxes above</i>
<b>Total for D 1</b>		<b>9</b>
<b>D 2</b>	<b>Does the wetland have the <u>opportunity</u> to improve water quality?</b> Answer YES if you know or believe there are pollutants in groundwater or surface water coming into the wetland that would otherwise reduce water quality in streams, lakes or groundwater downgradient from the wetland? <i>Note which of the following conditions provide the sources of pollutants. A unit may have pollutants coming from several sources, but any single source would qualify as opportunity.</i> ____ Grazing in the wetland or within 150 ft ____ Untreated stormwater discharges to wetland ____ Tilled fields or orchards within 150 ft. of wetland ____ A stream or culvert discharges into wetland that drains developed areas, residential areas, farmed fields, roads, or clear-cut logging <u>X</u> Residential, urban areas, golf courses are within 150 ft. of wetland ____ Wetland is fed by groundwater high in phosphorus or nitrogen ____ Other _____ <b>YES multiplier is 2</b> NO multiplier is 1	<i>(see p. 44)</i>  Multiplier  X2
<b>◆ TOTAL – Water Quality Functions</b>		<b>18</b>
HYDROLOGIC FUNCTIONS – Indicators that wetland unit functions to reduce flooding and stream degradation.		
<b>D 3</b>	<b>Does the wetland have the <u>potential</u> to reduce flooding and erosion?</b>	<i>(see p.46)</i>
D 3.1	Characteristics of surface water flows out of the wetland unit <ul style="list-style-type: none"> <li>• Unit is a depression with no surface water leaving it (no outlet)..... points = 4</li> <li>• <b>Unit has an intermittently flowing, OR highly constricted permanently flowing outlet..... points = 2</b></li> <li>• Unit is a “flat” depression (Q.7 on key) or in the Flats class, with permanent surface outflow <b>and no obvious natural outlet</b> and/or outlet is a man-made ditch..... points = 1 <i>(If ditch is not permanently flowing treat unit as “intermittently flowing”)</i></li> <li>• Unit has an unstricted, or slightly constricted, surface outlet (<i>permanently flowing</i>) ..... points = 0</li> </ul>	2
D 3.2	Depth of storage during wet periods. <i>Estimate the height of ponding above the bottom of the outlet. For units with no outlet measure from the surface of permanent water or deepest part (if dry).</i> <ul style="list-style-type: none"> <li>• Marks of ponding are 3 ft. or more above the surface or bottom of the outlet ..... points = 7</li> <li>• The wetland is a “headwater” wetland..... points = 5</li> <li>• Marks of ponding between 2 ft. to &lt; 3 ft. from surface or bottom of outlet ..... points = 5</li> <li>• <b>Marks are at least 0.5 ft. to &lt; 2 ft. from surface or bottom of outlet..... points = 3</b></li> <li>• Wetland is flat (yes to Q.2 or Q.7 on key)but has small depressions on the surface that trap water ..... points = 1</li> <li>• Marks of ponding less than 0.5 ft ..... points = 0</li> </ul>	3
D 3.3	Contribution of wetland unit to storage in the watershed: <i>Estimate the ratio of the area of upstream basin contributing surface water to the wetland to the area of the wetland unit itself.</i> <ul style="list-style-type: none"> <li>• The area of the basin is less than 10 times the area of unit..... points = 5</li> <li>• <b>The area of the basin is 10 to 100 times the area of the unit ..... points = 3</b></li> <li>• The area of the basin is more than 100 times the area of the unit ..... points = 0</li> <li>• Entire unit is in the FLATS class ..... points = 5</li> </ul>	3
<b>Total for D 3</b>		<i>Add the points in the boxes above</i>
<b>Total for D 3</b>		<b>8</b>

<b>D 4</b>	<p><b>Does the wetland have the <u>opportunity</u> to reduce flooding and erosion?</b></p> <p>Answer YES if the unit is in a location in the watershed where the flood storage, or reduction in water velocity, it provides helps protect downstream property and aquatic resources from flooding or excessive and/or erosive flows. Answer NO if the water coming into the wetland is controlled by a structure such as flood gate, tide gate, flap valve, reservoir etc. OR you estimate that more than 90% of the water in the wetland is from groundwater in areas where damaging groundwater flooding does not occur. <i>Note which of the following indicators of opportunity apply.</i></p> <p><input type="checkbox"/> Wetland is in a headwater of a river or stream that has flooding problems.</p> <p><input type="checkbox"/> Wetland drains to a river or stream that has flooding problems</p> <p><input checked="" type="checkbox"/> Wetland has no outlet and impounds surface runoff water that might otherwise flow into a river or stream that has flooding problems</p> <p><input type="checkbox"/> Other _____</p> <p><b>YES multiplier is 2</b>                      NO multiplier is 1</p>	<p>(see p. 49)</p> <p>Multiplier</p> <p><u>X2</u></p>
◆	<p><b>TOTAL – Hydrologic Functions</b>                      Multiply the score from D3 by D4; then <i>add score to table on p. 1</i></p>	<p>16</p>

Comments:







<p><i>These questions apply to wetlands of all HGM classes.</i></p> <p>HABITAT FUNCTIONS – Indicators that wetland functions to provide important habitat.</p>		<p><b>Points</b> (only 1 score per box)</p>
<b>H 1</b>	<b>Does the wetland have the <u>potential</u> to provide habitat for many species?</b>	
H 1.1	<p><u>Vegetation structure</u> (see P. 72):                      Check the types of vegetation classes present (as defined by Cowardin) – Size threshold for each class is 1/4 acre or more than 10% of the area if unit is smaller than 2.5 acres.</p> <p><input type="checkbox"/> Aquatic Bed  <input checked="" type="checkbox"/> Emergent plants  <input type="checkbox"/> Scrub/shrub (areas where shrubs have &gt; 30% cover)  <input type="checkbox"/> Forested (areas where trees have &gt; 30% cover)</p> <p>If the unit has a forested class check if:  <input type="checkbox"/> The forested class has 3 out of 5 strata (canopy, sub-canopy, shrubs, herbaceous, moss/ground-cover) that each cover 20% within the forested polygon.                      Add the number of vegetation types that qualify. If you have:</p> <p>4 structures or more..... points = 4                      3 structures..... points = 2                      2 structures..... points = 1</p> <p><b>Map of Cowardin vegetation classes</b>                      3 structures..... points = 2                      1 structure..... points = 0</p>	<p><b>Figure</b> ____</p> <p>0</p>
H 1.2	<p><u>Hydroperiods</u> (see p.73):                      Check the types of water regimes (hydroperiods) present within the wetland. The water regime has to cover more than 10% of the wetland or 1/4 acre to count (see text for descriptions of hydroperiods).</p> <p><input checked="" type="checkbox"/> Permanently flooded or inundated  <input checked="" type="checkbox"/> Seasonally flooded or inundated  <input type="checkbox"/> Occasionally flooded or inundated  <input checked="" type="checkbox"/> Saturated only</p> <p><input type="checkbox"/> Permanently flowing stream or river in, or adjacent to, the wetland  <input type="checkbox"/> Seasonally flowing stream in, or adjacent to, the wetland  <input type="checkbox"/> <b>Lake-fringe wetland..... = 2 points</b>  <input type="checkbox"/> <b>Freshwater tidal wetland..... = 2 points</b></p> <p><b>Map of hydroperiods</b>                      4 or more types present points = 3                      3 or more types present..... points = 2                      2 types present..... points = 1                      1 type present..... points = 0</p>	<p><b>Figure</b> ____</p> <p>2</p>
H 1.3	<p><u>Richness of Plant Species</u> (see p. 75):                      Count the number of plant species in the wetland that cover at least 10 ft<sup>2</sup> (different patches of the same species can be combined to meet the size threshold)                      You do not have to name the species. Do not include Eurasian Milfoil, reed canarygrass, purple loosestrife, Canadian Thistle.</p> <p>If you counted: &gt; 19 species..... points = 2                      5 – 19 species..... points = 1                      &lt; 5 species..... points = 0</p> <p>List species below if you want to:                      _____                      _____                      _____</p>	<p>1</p>
H 1.4	<p><u>Interspersion of Habitats</u> (see p. 76):                      Decided from the diagrams below whether interspersion between Cowardin vegetation (described in H1.1), or the classes and unvegetated areas (can include open water or mudflats) is high, medium, low, or none.</p> <div style="display: flex; justify-content: space-around;"> <div style="text-align: center;">  <p>None = 0 points</p> </div> <div style="text-align: center;">  <p>Low = 1 point</p> </div> <div style="text-align: center;">  <p>Moderate = 2 points</p> </div> </div> <div style="display: flex; justify-content: space-around; margin-top: 20px;"> <div style="text-align: center;">  <p>High = 3 points</p> </div> <div style="text-align: center;">  <p>[riparian braided channels]</p> </div> </div> <p>Note: If you have 4 or more classes or 3 vegetation classes and open water, the rating is always “high”.                      Use map of Cowardin classes.</p>	<p><b>Figure</b> ____</p> <p>0</p>
H 1.5	<p><u>Special Habitat Features</u> (see p. 77):                      Check the habitat features that are present in the wetland. The number of checks is the number of points you put into the next column.</p> <p><input type="checkbox"/> Large, downed, woody debris within the wetland (&gt; 4 in. diameter and 6 ft. long)  <input type="checkbox"/> Standing snags (diameter at the bottom &gt; 4 inches) in the wetland  <input type="checkbox"/> Undercut banks are present for at least 6.6 ft. (2m) and/or overhanging vegetation extends at least 3.3 ft. (1m) over a stream (or ditch) in, or contiguous with the unit, for at least 33 ft. (10m)  <input type="checkbox"/> Stable steep banks of fine material that might be used by beaver or muskrat for denning (&gt; 30 degree slope) OR signs of recent beaver activity are present (cut shrubs or trees that have not yet turned grey/brown)  <input type="checkbox"/> At least 1/4 acre of thin-stemmed persistent vegetation or woody branches are present in areas that are permanently or seasonally inundated (structures for egg-laying by amphibians)  <input type="checkbox"/> Invasive plants cover less than 25% of the wetland area in each stratum of plants</p> <p>NOTE: The 20% stated in early printings of the manual on page 78 is an error.</p>	<p>0</p>
<b>H 1 TOTAL Score – potential for providing habitat</b>		<p>Add the points in the column.</p> <p><b>3</b></p>

Exhibit 16  
SSDP2016-00415  
001028

<b>H 2</b>	<b>Does the wetland have the <u>opportunity</u> to provide habitat for many species?</b>	(only 1 score per box)
	<p>H 2.1 <b>Buffers</b> (see P. 80):  <i>Choose the description that best represents condition of buffer of wetland unit. The highest scoring criterion that applies to the wetland is to be used in the rating. See text for definition of "undisturbed".</i></p> <p><input type="checkbox"/> 100m (330 ft) of relatively undisturbed vegetated areas, rocky areas, or open water &gt; 95% of circumference. No structures are within the undisturbed part of buffer (relatively undisturbed also means no grazing, no landscaping, no daily human use)..... <b>points = 5</b></p> <p><input type="checkbox"/> 100m (330 ft) of relatively undisturbed vegetated areas, rocky areas, or open water &gt; 50% circumference..... <b>points = 4</b></p> <p><input type="checkbox"/> 50m (170 ft) of relatively undisturbed vegetated areas, rocky areas, or open water &gt; 95% circumference..... <b>points = 4</b></p> <p><input type="checkbox"/> 100m (330 ft) of relatively undisturbed vegetated areas, rocky areas, or open water &gt; 25% circumference..... <b>points = 3</b></p> <p><input type="checkbox"/> 50m (170 ft) of relatively undisturbed vegetated areas, rocky areas, or open water for &gt; 50% circumference..... <b>points = 3</b></p> <p><b>If buffer does not meet any of the criteria above:</b></p> <p><input type="checkbox"/> No paved areas (except paved trails) or buildings within 25m (80 ft) of wetland &gt; 95% circumference. Light to moderate grazing or lawns are OK..... <b>points = 2</b></p> <p><input type="checkbox"/> No paved areas of buildings within 50m of wetland for &gt; 50% circumference. Light to moderate grazing or lawns are OK..... <b>points = 2</b></p> <p><input type="checkbox"/> Heavy grazing in buffer..... <b>points = 1</b></p> <p><input type="checkbox"/> Vegetated buffers are &lt; 2m wide (6.6 ft) for more than 95% circumference (e.g. tilled fields, paving, basalt bedrock extend to edge of wetland)..... <b>points = 0</b></p> <p><input checked="" type="checkbox"/> Buffer does not meet any of the criteria above..... <b>points = 1</b></p> <p style="text-align: right;"><b>Arial photo showing buffers</b></p>	<p><b>Figure</b> _____</p> <p style="text-align: center;">1</p>
	<p>H 2.2 <b>Corridors and Connections</b> (see p. 81)</p> <p>H 2.2.1 Is the wetland part of a relatively undisturbed and unbroken vegetated corridor (either riparian or upland) that is at least 150 ft. wide, has at least a 30% cover of shrubs, forest or native undisturbed prairie, that connects to estuaries, other wetlands or undisturbed uplands that are at least 250 acres in size? (<i>Dams in riparian corridors, heavily used gravel roads, paved roads, are considered breaks in the corridor.</i>)</p> <p style="text-align: center;">YES = <b>4 points</b> (go to H 2.3)                      NO = go to H 2.2.2</p> <p>H. 2.2.2 Is the wetland part of a relatively undisturbed and unbroken vegetated corridor (either riparian or upland) that is at least 50 ft. wide, has at least 30% cover of shrubs or forest, and connects to estuaries, other wetlands or undisturbed uplands that are at least 25 acres in size? <b>OR a Lake-fringe wetland</b>, if it does not have an undisturbed corridor as in the question above?</p> <p style="text-align: center;">YES = <b>2 points</b> (go to H 2.3)                      NO = go to H 2.2.3</p> <p>H. 2.2.3 Is the wetland:</p> <ul style="list-style-type: none"> <li>• Within 5 mi (8km) of a brackish or salt water estuary OR</li> <li>• Within 3 miles of a large field or pasture (&gt; 40 acres) OR                      YES = 1 point</li> <li>• <b>Within 1 mile of a lake greater than 20 acres?</b>                      NO = 0 points</li> </ul>	<p style="text-align: center;">1</p>

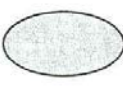
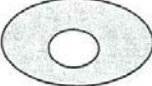
Comments:

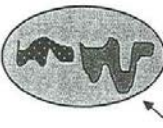
	<p>H 2.3 <u>Near or adjacent to other priority habitats listed by WDFW</u> (see p. 82): (see new and complete descriptions of WDFW priority habitats, and the counties in which they can be found, in the PHS report <a href="http://wdfw.wa.gov/hab/phslist.htm">http://wdfw.wa.gov/hab/phslist.htm</a> )</p> <p>Which of the following priority habitats are within 330 ft. (100m) of the wetland unit?  <i>NOTE: the connections do not have to be relatively undisturbed.</i></p> <p><input type="checkbox"/> <b>Aspen Stands:</b> Pure or mixed stands of aspen greater than 0.4 ha (1 acre).</p> <p><input type="checkbox"/> <b>Biodiversity Areas and Corridors:</b> Areas of habitat that are relatively important to various species of native fish and wildlife (full descriptions in WDFW PHS report p. 152).</p> <p><input type="checkbox"/> <b>Herbaceous Balds:</b> Variable size patches of grass and forbs on shallow soils over bedrock.</p> <p><input type="checkbox"/> <b>Old-growth/Mature forests:</b> (Old-growth west of Cascade crest) Stands of at least 2 tree species, forming a multi-layered canopy with occasional small openings; with at least 20 trees/ha (8 trees/acre) &gt; 81 cm (32 in) dbh or &gt; 200 years of age. (Mature forests) Stands with average diameters exceeding 53 cm (21 in) dbh; crown cover may be less than 100%; decay, decadence, numbers of snags, and quantity of large downed material is generally less than that found in old-growth; 80 - 200 years old west of the Cascade crest.</p> <p><input type="checkbox"/> <b>Oregon white Oak:</b> Woodlands Stands of pure oak or oak/conifer associations where canopy coverage of the oak component is important (full descriptions in WDFW PHS report p. 158).</p> <p><input checked="" type="checkbox"/> <b>Riparian:</b> The area adjacent to aquatic systems with flowing water that contains elements of both aquatic and terrestrial ecosystems which mutually influence each other.</p> <p><input type="checkbox"/> <b>Westside Prairies:</b> Herbaceous, non-forested plant communities that can either take the form of a dry prairie or a wet prairie (full descriptions in WDFW PHS report p. 161).</p> <p><input checked="" type="checkbox"/> <b>Instream:</b> The combination of physical, biological, and chemical processes and conditions that interact to provide functional life history requirements for instream fish and wildlife resources.</p> <p><input type="checkbox"/> <b>Nearshore:</b> Relatively undisturbed nearshore habitats. These include Coastal Nearshore, Open Coast Nearshore, and Puget Sound Nearshore. (full descriptions of habitats and the definition of relatively undisturbed are in WDFW report: pp. 167-169 and glossary in Appendix A).</p> <p><input type="checkbox"/> <b>Caves:</b> A naturally occurring cavity, recess, void, or system of interconnected passages under the earth in soils, rock, ice, or other geological formations and is large enough to contain a human.</p> <p><input type="checkbox"/> <b>Cliffs:</b> Greater than 7.6 m (25 ft) high and occurring below 5000 ft.</p> <p><input type="checkbox"/> <b>Talus:</b> Homogenous areas of rock rubble ranging in average size 0.15 - 2.0 m (0.5 - 6.5 ft), composed of basalt, andesite, and/or sedimentary rock, including riprap slides and mine tailings. May be associated with cliffs.</p> <p><input type="checkbox"/> <b>Snags and Logs:</b> Trees are considered snags if they are dead or dying and exhibit sufficient decay characteristics to enable cavity excavation/use by wildlife. Priority snags have a diameter at breast height of &gt; 51 cm (20 in) in western Washington and are &gt; 2 m (6.5 ft) in height. Priority logs are &gt; 30 cm (12 in) in diameter at the largest end, and &gt; 6 m (20 ft) long.</p> <p>If wetland has <b>3 or more</b> priority habitats = <b>4 points</b>  <b>If wetland has 2</b> priority habitats = <b>3 points</b>                  If wetland has <b>1</b> priority habitat = <b>1 point</b>                      No habitats = 0 points</p> <p>Note: All vegetated wetlands are by definition a priority habitat but are not included in this list. Nearby wetlands are addressed in question H 2.4)</p>	3
	<p>H 2.4 <u>Wetland Landscape:</u> Choose the <b>one</b> description of the landscape around the wetland that best fits (see p. 84)</p> <ul style="list-style-type: none"> <li>• There are at least 3 other wetlands within 1/2 mile, and the connections between them are relatively undisturbed (light grazing between wetlands OK, as is lake shore with some boating, but connections should NOT be bisected by paved roads, fill, fields, or other development.....points = 5</li> <li>• The wetland is Lake-fringe on a lake with little disturbance and there are 3 other lake-fringe wetlands within 1/2 mile .....points = 5</li> <li>• <b>There are at least 3 other wetlands within 1/2 mile, BUT the connections between them are disturbed.....points = 3</b></li> <li>• The wetland fringe on a lake <b>with</b> disturbance and there are 3 other lake-fringe wetlands within 1/2 mile .....points = 3</li> <li>• There is at least 1 wetland within 1/2 mile .....points = 2</li> <li>• There are no wetlands within 1/2 mile.....points = 0</li> </ul>	3
<b>H 2 TOTAL Score – opportunity for providing habitat</b> <i>Add the scores from H2.1, H2.2, H2.3, H2.4</i>		8
<i>TOTAL for H 1 from page 8</i>		3
◆	<b>Total Score for Habitat Functions</b> Add the points for H 1 and H 2; then <b>record the result on p. 1</b>	11

Comments:

**CATEGORIZATION BASED ON SPECIAL CHARACTERISTICS**

*Please determine if the wetland meets the attributes described below  
and circle the appropriate answers and Category.*

Wetland Type – Check off any criteria that apply to the wetland. Circle the Category when the appropriate criteria are met.	
<b>SC1</b>	<b>Estuarine wetlands?</b> (see p.86) Does the wetland unit meet the following criteria for Estuarine wetlands? <input type="checkbox"/> The dominant water regime is tidal, <input type="checkbox"/> Vegetated, and <input type="checkbox"/> With a salinity greater than 0.5 ppt. YES = Go to SC 1.1    NO <u><b>X</b></u>
	SC 1.1 Is the wetland unit within a National Wildlife Refuge, National Park, National Estuary Reserve, Natural Area Preserve, State Park or Educational, Environmental, or Scientific Reserve designated under WAC 332-30-151?    YES = Category I    NO = go to SC 1.2 <b>Cat. I</b>
	SC 1.2 Is the wetland at least 1 acre in size and meets at least two of the following conditions? YES = Category I    NO = Category II <input type="checkbox"/> The wetland is relatively undisturbed (has no diking, ditching, filling, cultivation, grazing, and has less than 10% cover of non-native plant species. If the non-native <i>Spartina</i> spp., are only species that cover more than 10% of the wetland, then the wetland should be given a dual rating (I/II). The area of <i>Spartina</i> would be rated a Category II while the relatively undisturbed upper marsh with native species would be a Category I. Do not, however, exclude the area of <i>Spartina</i> in determining the size threshold of 1 acre. <input type="checkbox"/> At least 3/4 of the landward edge of the wetland has a 100 ft. buffer of shrub, forest, or un-grazed or un-mowed grassland <input type="checkbox"/> The wetland has at least 2 of the following features: tidal channels, depressions with open water, or contiguous freshwater wetlands. <b>Cat. I</b> <b>Cat. II</b> <b>Dual Rating I/II</b>
<b>SC2</b>	<b>Natural Heritage Wetlands</b> (see p. 87) Natural Heritage wetlands have been identified by the Washington Natural Heritage Program/DNR as either high quality undisturbed wetlands or wetlands that support state Threatened, Endangered, or Sensitive plant species. SC 2.1 Is the wetland being rated in a Section/Township/Range that contains a natural heritage wetland? (This question is used to screen out most sites before you need to contact WNHP/DNR.) S/T/R information from Appendix D _____ or accessed from WNHP/DNR web site _____ YES _____ Contact WNHP/DNR (see p. 79) and go to SC 2.2    NO <u><b>X</b></u> SC 2.2 Has DNR identified the wetland as a high quality undisturbed wetland or as a site with state threatened or endangered plant species? YES = Category 1    NO _____ not a Heritage Wetland <b>Cat I</b>
<b>SC3</b>	<b>Bogs</b> (see p. 87) Does the wetland ( <b>or any part of the unit</b> ) meet both the criteria for soils and vegetation in bogs? Use the key below to identify if the wetland is a bog. <i>If you answer yes you will still need to rate the wetland based on its function.</i> 1. Does the unit have organic soil horizons (i.e. layers of organic soil), either peats or mucks, that compose 16 inches or more of the first 32 inches of soil profile? (See Appendix B for a field key to identify organic soils)?    YES = go to question 3    NO = go to question 2 2. Does the wetland have organic soils, either peats or mucks that are less than 16 inches deep over bedrock, or an impermeable hardpan such as clay or volcanic ash, or that are floating on a lake or pond?    YES = go to question 3    NO = is not a bog for purpose of rating 3. Does the unit have more than 70% cover of mosses at ground level, AND other plants, if present, consist of the “bog” species listed in Table 3 as a significant component of the vegetation (more than 30% of the total shrub and herbaceous cover consists of species in Table 3)? YES = Is a bog for purpose of rating    NO = go to question 4 NOTE: If you are uncertain about the extent of mosses in the understory you may substitute that criterion by measuring the pH of the water that seeps into a hole dug at least 16” deep. If the pH is less than 5.0 and the “bog” plant species in Table 3 are present, the wetland is a bog. 4. Is the unit forested (> 30% cover) with sitka spruce, subalpine fir, western red cedar, western hemlock, lodgepole pine, quaking aspen, Englemann’s spruce, or western white pine. WITH any of the species (or combination of species) on the bog species plant list in Table 3 as a significant component of the ground cover (> 30% coverage of the total shrub/herbaceous cover)? YES = Category I    NO = Is not a bog for purpose of rating <b>Cat. I</b>

Exhibit 16  
SSDP2016-00415  
001031

SC4	<p><b>Forested Wetlands</b> (see p. 90)</p> <p>Does the wetland have at least 1 acre of forest that meet one of these criteria for the Department of Fish and Wildlife's forests as priority habitats? <i>If you answer yes you will still need to rate the wetland based on its function.</i></p> <p>___ <b>Old-growth forests:</b> (west of Cascade Crest) Stands of at least two three species forming a multi-layered canopy with occasional small openings; with at least 8 trees/acre (20 trees/hectare) that are at least 200 years of age OR have a diameter at breast height (dbh) of 32 inches (81 cm or more).</p> <p>NOTE: The criterion for dbh is based on measurements for upland forests. Two-hundred year old trees in wetlands will often have a smaller dbh because their growth rates are often slower. The DFW criterion is and "OR" so old-growth forests do not necessarily have to have trees of this diameter.</p> <p>___ <b>Mature forests:</b> (west of the Cascade Crest) Stands where the largest trees are 80 – 200 years old OR have an average diameters (dbh) exceeding 21 inches (53 cm); crown cover may be less than 100%; decay, decadence, numbers of snags, and quantity of large downed material is generally less than that found in old-growth.</p> <p>YES = Category I                      NO = <u>X</u> not a forested wetland with special characteristics</p>	Cat. I
SC5	<p><b>Wetlands in Coastal Lagoons</b> (see p. 91)</p> <p>Does the wetland meet all of the following criteria of a wetland in a coastal lagoon?</p> <p>___ The wetland lies in a depression adjacent to marine waters that is wholly or partially separated from marine waters by sandbanks, gravel banks, shingle, or, less frequently, rocks.</p> <p>___ The lagoon in which the wetland is located contains surface water that is saline or brackish (&gt; 0.5 ppt) during most of the year in at least a portion of the lagoon (<i>needs to be measured near the bottom.</i>)</p> <p>YES = Go to SC 5.1                      NO <u>X</u> not a wetland in a coastal lagoon</p> <p>SC 5.1 Does the wetland meet all of the following three conditions?</p> <p>___ The wetland is relatively undisturbed (has no diking, ditching, filling, cultivation, grazing) and has less than 20% cover of invasive plant species (see list of invasive species on p. 74).</p> <p>___ At least 3/4 of the landward edge of the wetland has a 100 ft. buffer of shrub, forest, or un-grazed or un-mowed grassland.</p> <p>___ The wetland is larger than 1/10 acre (4350 square ft.)</p> <p>YES = Category I                      NO = Category II</p>	Cat. I Cat. II
SC6	<p><b>Interdunal Wetlands</b> (see p. 93)</p> <p>Is the wetland west of the 1889 line (also called the Western Boundary of Upland Ownership or WBUO)?</p> <p>YES = Go to SC 6.1                      NO <u>X</u> not an interdunal wetland for rating</p> <p><i>If you answer yes you will still need to rate the wetland based on its functions.</i></p> <p>In practical terms that means the following geographic areas:</p> <ul style="list-style-type: none"> <li>• Long Beach Peninsula -- lands west of SR 103</li> <li>• Grayland-Westport -- lands west of SR 105</li> <li>• Ocean Shores-Copalis – lands west of SR 115 and SR 109</li> </ul> <p>SC 6.1 Is the wetland one acre or larger, or is it in a mosaic of wetlands that is one acre or larger?</p> <p>YES = Category II                      NO = go to SC 6.2</p> <p>SC 6.2 Is the wetland between 0.1 and 1 acre, or is it in a mosaic of wetlands that is between 0.1 and 1 acre?</p> <p>YES = Category III</p>	Cat. II Cat. III
◆	<p><b>Category of wetland based on Special Characteristics</b></p> <p>Choose the "highest" rating if wetland falls into several categories, and record on p. 1.</p> <p>If you answered NO for all types enter "Not Applicable" on p. 1</p>	NA

Comments:

Wetland name or number 21AC

**WETLAND RATING FORM – WESTERN WASHINGTON**  
Version 2 – Updated July 2006 to increase accuracy and reproducibility among users  
Updated Oct. 2008 with the new WDFW definitions for priority habitats

Name of wetland (if known): 21AC Date of site visit: 10-31-07 (rev: 03-19-14)

Rated by: Colin Worsley / Matt Maynard Trained by Ecology? Yes X No     Date of training: 11- 2005 / 04-2006

SEC: 06 TOWNSHIP: 24N RANGE: 06E Is S/T/R in Appendix D? Yes     No X

Map of wetland unit: Figure                      Estimated size ~0.40 acre

**SUMMARY OF RATING**

Category based on FUNCTIONS provided by wetland: I     II     III     **X** IV    

Category I =	Score > 70
Category II =	Score 51 - 69
Category III =	Score 30 – 50
Category IV =	Score < 30

Score for Water Quality Functions	18
Score for Hydrologic Functions	4
Score for Habitat Functions	12
<b>TOTAL Score for Functions</b>	<b>34</b>

Category based on SPECIAL CHARACTERISTICS of Wetland I     II     Does not apply **X**

**Final Category** (choose the “highest” category from above”) **III**

**Summary of basic information about the wetland unit.**

Wetland Unit has Special Characteristics		Wetland HGM Class used for Rating	
<b>Estuarine</b>		<b>Depressional</b>	
<b>Natural Heritage Wetland</b>		<b>Riverine</b>	
<b>Bog</b>		<b>Lake-fringe</b>	<b>X</b>
<b>Mature Forest</b>		<b>Slope</b>	<b>(x)</b>
<b>Old Growth Forest</b>		<b>Flats</b>	
<b>Coastal Lagoon</b>		<b>Freshwater Tidal</b>	
<b>Interdunal</b>			
None of the above	<b>X</b>	Check if unit has multiple HGM classes present	<b>X</b>

**Does the wetland being rated meet any of the criteria below?** If you answer YES to any of the questions below you will need to protect the wetland according to the regulations regarding the special characteristics found in the wetland.

<b>Check List for Wetlands that Need Additional Protection (in addition to the protection recommended for its category)</b>	<b>YES</b>	<b>NO</b>
SP1. <i>Has the wetland unit been documented as a habitat for any Federally listed Threatened or Endangered <b>animal or plant</b> species (T/E species)?</i> For the purposes of this rating system, “documented” means the wetland is on the appropriate state or federal database.		X
SP2. <i>Has the wetland unit been documented as habitat for any State listed Threatened or Endangered <b>animal</b> species?</i> For the purposes of this rating system, “documented” means the wetland is on the appropriate state database. Note: Wetlands with State listed plant species are categorized as Category 1 Natural Heritage Wetlands (see p. 19 of data form).		X
SP3. <i>Does the wetland unit contain individuals of Priority species listed by the WDFW for the state?</i>		X
SP4. <i>Does the wetland unit have a local significance in addition to its functions?</i> For example, the wetland has been identified in the Shoreline Master Program, the Critical Areas Ordinance, or in a local management plan as having special significance.		X

To complete the next part of the data sheet you will need to determine the Hydrogeomorphic Class of the wetland being rated.

Exhibit 16  
SSDP2016-00415  
001033

### Classification of Vegetated Wetlands for Western Washington

If the hydrologic criteria listed in each question do not apply to the entire unit being rated, you probably have a unit with multiple HGM classes. In this case, identify which hydrologic criteria in questions 1-7 apply, and go to Question 8.

1. Are the water levels in the entire unit usually controlled by tides (i.e. except during floods)?  
NO – go to 2                      **YES – the wetland class is Tidal Fringe**  
 If yes, is the salinity of the water during periods of annual low flow below 0.5 ppt (parts per thousand)?  
**YES – Freshwater Tidal Fringe**                      **NO – Saltwater Tidal Fringe (Estuarine)**  
*If your wetland can be classified as a Freshwater Tidal Fringe use the forms for Riverine wetlands. If it is a Saltwater Tidal Fringe it is rated as an Estuarine wetland. Wetlands that were call estuarine in the first and second editions of the rating system are called Salt Water Tidal Fringe in the Hydrogeomorphic Classification. Estuarine wetlands were categorized separately in the earlier editions, and this separation is being kept in this revision. To maintain consistency between editions, the term “Estuarine” wetland is kept. Please note, however, that the characteristics that define Category I and II estuarine wetlands have changed (see p. \_\_\_\_).*

---

2. The entire wetland unit is flat and precipitation is only source (>90%) of water to it. Groundwater and surface water runoff are NOT sources of water to the unit.  
NO – go to 3                      **YES – The wetland class is Flats**  
 If your wetland can be classified as a “Flats” wetland, use the form for **Depressional** wetlands.

---

3. Does the entire wetland meet both of the following criteria?  
 \_\_\_\_ The vegetated part of the wetland is on the shores of a body of permanent open water (without any vegetation on the surface) where at least 20 acres (8ha) in size;  
 \_\_\_\_ At least 30% of the open water area is deeper than 6.6 (2 m)?  
NO – go to 4                      **YES – The wetland class is Lake-fringe (Lacustrine Fringe)**

---

4. Does the entire wetland meet all of the following criteria?  
 \_\_\_\_ The wetland is on a slope (*slope can be very gradual*).  
 \_\_\_\_ The water flows through the wetland in one direction (unidirectional) and usually comes from seeps. It may flow subsurface, as sheetflow, or in a swale without distinct banks.  
 \_\_\_\_ The water leaves the wetland **without being impounded**?  
 NOTE: *Surface water does not pond in these types of wetlands except occasionally in very small and shallow depressions or behind hummocks (depressions are usually <3 ft diameter and less than 1 foot deep).*  
NO – go to 5                      **YES – The wetland class is Slope**

---

5. Does the entire wetland meet all of the following criteria?  
 \_\_\_\_ The unit is in a valley or stream channel where it gets inundated by overbank flooding from that stream or river.  
 \_\_\_\_ The overbank flooding occurs at least once every two years.  
 NOTE: *The riverine unit can contain depressions that are filled with water when the river is not flooding..*  
NO – go to 6                      **YES – The wetland class is Riverine**

---

6. Is the entire wetland unit in a topographic depression in which water ponds, or is saturated to the surface, at some time of the year. This means that any outlet, if present is higher than the interior of the wetland.  
NO – go to 7                      **YES – The wetland class is Depressional**

---

7. Is the entire wetland located in a very flat area with no obvious depression and no overbank flooding. The unit does not pond surface water more than a few inches. The unit seems to be maintained by high groundwater in the area. The wetland may be ditched, but has no obvious natural outlet.  
No – go to 8                      **YES – The wetland class is Depressional**

---

8. Your wetland unit seems to be difficult to classify and probably contains several different HGM classes. For example, seeps at the base of a slope may grade into a riverine floodplain, or a small stream within a depressional wetland has a zone of flooding along its sides. **GO BACK AND IDENTIFY WHICH OF THE HYDROLOGIC REGIMES DESCRIBED IN QUESTIONS 1-7 APPLY TO DIFFERENT AREAS IN THE UNIT** (make a rough sketch to help you decide). Use the following table to identify the appropriate class to use for the rating system if you have several HGM classes present within your wetland. NOTE: Use this table only if the class that is recommended in the second column represents 10% or more of the total area of the wetland unit being rated. If the area of the class listed in column 2 is less than 10% of the unit, classify the wetland using the class that represents more than 90% of the total area.

HGM Classes within the wetland unit being rated	HGM Class to Use in Rating
Slope + Riverine	Riverine
Slope + Depressional	Depressional
Slope + Lake-fringe	Lake-fringe
Depressional + Riverine along stream within boundary	Depressional
Depressional + Lake-fringe	Depressional
Salt Water Tidal Fringe and any other class of freshwater wetland	Treat as ESTUARINE under wetlands with special characteristics

**Exhibit 16**  
**SSDP2016-00415**  
**001034**

If you are unable still to determine which of the above criteria apply to your wetland, or you have more than 2 HGM classes within a wetland boundary, classify the wetland as **Depressional** for the rating.

L Lake-fringe Wetlands		Points
WATER QUALITY FUNCTIONS – Indicators that the wetland unit functions to improve water quality.		(only 1 score per box)
<b>L 1</b>	<b>Does the wetland unit have the <u>potential</u> to improve water quality?</b> (see p.59)	
	L 1.1 Average width of vegetation along the lakeshore (use polygons of Cowardin classes): • Vegetation is more than 33 ft. (10m) wide ..... points = 6 • <b>Vegetation is more than 16 ft.(5m) wide and &lt; 33 ft ..... points = 3</b> • Vegetation is more than 6 ft. (2m) wide and < 16 ft ..... points = 1 • Vegetation is less than 6 ft. wide..... points = 0 <b>Map of Cowardin classes with widths marked</b>	Figure ____ 3
	L 1.2 Characteristics of the vegetation in the wetland: <i>Choose the appropriate description that results in the highest points, and do not include any open water in your estimate of coverage. The herbaceous plants can be either the dominant form or as an understory in a shrub or forest community. These are not Cowardin classes. Area of Cover is total cover in the unit, but it can be in patches. NOTE: Herbaceous does not include aquatic bed.</i> • Cover of herbaceous plants is > 90% of the vegetated area..... points = 6 • Cover of herbaceous plants is > 2/3 of the vegetated area..... points = 4 • Cover of herbaceous plants is > 1/3 of the vegetated area..... points = 3 • Other vegetation that is not aquatic bed or herbaceous covers > 2/3 of the unit ..... points = 3 • Other vegetation that is not aquatic bed in > 1/3 vegetated area ..... points = 1 • Aquatic bed cover and open water > 2/3 of the unit..... points = 0 <b>Map with polygons of different vegetation types</b>	Figure ____ 6
<i>Add the points in the boxes above</i>		<b>9</b>
<b>L 2</b>	<b>Does the wetland have the <u>opportunity</u> to improve water quality?</b>	(see p.61)
	Answer YES if you know or believe there are pollutants in the lake water, or polluted surface water flowing through the unit to the lake. <i>Note which of the following conditions provide the sources of pollutants. A unit may have pollutants coming from several sources, but any single source would qualify as opportunity.</i> ___ Wetland is along the shores of a lake or reservoir that does not meet water quality standards ___ Grazing in the wetland or within 150 ft ___ Polluted water discharges to wetland along upland edge ___ Tilled fields or orchards within 150 ft. of wetland <input checked="" type="checkbox"/> Residential or urban areas are within 150 ft. of wetland ___ Parks with grassy areas that are maintained, ballfields, golf courses (all within 150 ft. of lake shore) <input checked="" type="checkbox"/> Power boats with gasoline or diesel engines use the lake ___ Other _____ <b>YES multiplier is 2</b> NO multiplier is 1	Multiplier <b>X2</b>
<b>◆</b>	<b>TOTAL – Water Quality Functions</b> Multiply the score from L1 by L2; then <i>add score to table on p. 1</i>	<b>18</b>
HYDROLOGIC FUNCTIONS – Indicators that wetland functions to reduce shoreline erosion.		
<b>L 3</b>	<b>Does the wetland have the <u>potential</u> to reduce shoreline erosion?</b>	(see p.62)
	L 3 Average width and characteristics of vegetation along the lakeshore ( <i>do not include aquatic bed</i> ): ( <i>choose the highest scoring description that matches conditions in the wetland</i> ) • 3/4 of distance is shrubs or forest at least 33 ft. (10m) wide ..... points = 6 • 3/4 of distance is shrubs or forest at least 6 ft. (2m) wide..... points = 4 • 1/4 of distance is shrubs or forest at least 33 ft. (10m) wide..... points = 4 • <b>Vegetation is at least 6 ft. (2m) wide (any type except aquatic bed)..... points = 2</b> • Vegetation is less than 6 ft. (2m) wide (any type except aquatic bed) ..... points = 0 <b>Aerial photo or map with Cowardin vegetation classes</b>	Figure ____ 2
<i>Record the points in the boxes above</i>		<b>2</b>
<b>L 4</b>	<b>Does the wetland have the <u>opportunity</u> to reduce erosion?</b>	(see p. 64)
	Are there features along the shore that will be impacted if the shoreline erodes? <i>Note which of the following conditions apply.</i> <input checked="" type="checkbox"/> There are human structures and activities along the upland edge of the wetland (buildings, fields) that can be damaged by erosion. ___ There are undisturbed natural resources along the upland edge of the wetland (e.g. mature forests, other wetlands) that can be damaged by shoreline erosion. ___ Other _____ <b>YES multiplier is 2</b> NO multiplier is 1	Multiplier <b>X2</b>
<b>◆</b>	<b>TOTAL – Hydrologic Functions</b> Multiply the score from L3 by L4; then <i>add score to table on p. 1</i>	<b>4</b>

Comments: Majority of herbaceous vegetation is maintained lawn.







These questions apply to wetlands of all HGM classes.		Points (only 1 score per box)
HABITAT FUNCTIONS – Indicators that wetland functions to provide important habitat.		
<b>H 1</b>	<b>Does the wetland have the <u>potential</u> to provide habitat for many species?</b>	
H 1.1	<p><u>Vegetation structure</u> (see P. 72): Check the types of vegetation classes present (as defined by Cowardin) – Size threshold for each class is 1/4 acre or more than 10% of the area if unit is smaller than 2.5 acres.</p> <p><input type="checkbox"/> Aquatic Bed <input checked="" type="checkbox"/> Emergent plants <input type="checkbox"/> Scrub/shrub (areas where shrubs have &gt; 30% cover) <input type="checkbox"/> Forested (areas where trees have &gt; 30% cover) If the unit has a forested class check if: <input type="checkbox"/> The forested class has 3 out of 5 strata (canopy, sub-canopy, shrubs, herbaceous, moss/ground-cover) that each cover 20% within the forested polygon. Add the number of vegetation types that qualify. If you have: 4 structures or more..... points = 4 3 structures ..... points = 2 2 structures ..... points = 1</p> <p><b>Map of Cowardin vegetation classes</b> 3 structures ..... points = 2 1 structure ..... points = 0</p>	Figure ____  0
H 1.2	<p><u>Hydroperiods</u> (see p.73): Check the types of water regimes (hydroperiods) present within the wetland. The water regime has to cover more than 10% of the wetland or 1/4 acre to count (see text for descriptions of hydroperiods).</p> <p><input type="checkbox"/> Permanently flooded or inundated <input type="checkbox"/> Seasonally flooded or inundated <input type="checkbox"/> Occasionally flooded or inundated <input type="checkbox"/> Saturated only <input type="checkbox"/> Permanently flowing stream or river in, or adjacent to, the wetland <input type="checkbox"/> Seasonally flowing stream in, or adjacent to, the wetland <input checked="" type="checkbox"/> Lake-fringe wetland ..... = 2 points <input type="checkbox"/> Freshwater tidal wetland ..... = 2 points</p> <p><b>Map of hydroperiods</b></p>	Figure ____  2
H 1.3	<p><u>Richness of Plant Species</u> (see p. 75): Count the number of plant species in the wetland that cover at least 10 ft<sup>2</sup> (different patches of the same species can be combined to meet the size threshold) You do not have to name the species. Do not include Eurasian Milfoil, reed canarygrass, purple loosestrife, Canadian Thistle. If you counted: &gt; 19 species ..... points = 2 5 – 19 species ..... points = 1 &lt; 5 species ..... points = 0</p> <p>List species below if you want to: _____ _____ _____</p>	Figure ____  1
H 1.4	<p><u>Interspersion of Habitats</u> (see p. 76): Decided from the diagrams below whether interspersion between Cowardin vegetation (described in H1.1), or the classes and unvegetated areas (can include open water or mudflats) is high, medium, low, or none.</p> <div style="display: flex; justify-content: space-around;"> <div style="text-align: center;">  None = 0 points         </div> <div style="text-align: center;">  Low = 1 point         </div> <div style="text-align: center;">  Moderate = 2 points         </div> <div style="text-align: center;">  High = 3 points         </div> </div> <p>[riparian braided channels]</p> <p>Note: If you have 4 or more classes or 3 vegetation classes and open water, the rating is always "high".</p> <p><b>Use map of Cowardin classes.</b></p>	Figure ____  0
H 1.5	<p><u>Special Habitat Features</u> (see p. 77): Check the habitat features that are present in the wetland. The number of checks is the number of points you put into the next column.</p> <p><input type="checkbox"/> Large, downed, woody debris within the wetland (&gt; 4 in. diameter and 6 ft. long) <input type="checkbox"/> Standing snags (diameter at the bottom &gt; 4 inches) in the wetland <input type="checkbox"/> Undercut banks are present for at least 6.6 ft. (2m) and/or overhanging vegetation extends at least 3.3 ft. (1m) over a stream (or ditch) in, or contiguous with the unit, for at least 33 ft. (10m) <input type="checkbox"/> Stable steep banks of fine material that might be used by beaver or muskrat for denning (&gt; 30 degree slope) OR signs of recent beaver activity are present (cut shrubs or trees that have not yet turned grey/brown) <input type="checkbox"/> At least 1/4 acre of thin-stemmed persistent vegetation or woody branches are present in areas that are permanently or seasonally inundated (structures for egg-laying by amphibians) <input type="checkbox"/> Invasive plants cover less than 25% of the wetland area in each stratum of plants NOTE: The 20% stated in early printings of the manual on page 78 is an error.</p>	Figure ____  0
<b>H 1 TOTAL Score</b> – potential for providing habitat		3

Exhibit 16  
SSP 2016-00215  
001036

<b>H 2</b>	<b>Does the wetland have the <u>opportunity</u> to provide habitat for many species?</b>	(only 1 score per box)
	<p>H 2.1 <b>Buffers</b> (see P. 80):  <i>Choose the description that best represents condition of buffer of wetland unit. The highest scoring criterion that applies to the wetland is to be used in the rating. See text for definition of "undisturbed".</i></p> <p>___ 100m (330 ft) of relatively undisturbed vegetated areas, rocky areas, or open water &gt; 95% of circumference. No structures are within the undisturbed part of buffer (relatively undisturbed also means no grazing, no landscaping, no daily human use)..... <b>points = 5</b></p> <p>___ 100m (330 ft) of relatively undisturbed vegetated areas, rocky areas, or open water &gt; 50% circumference ..... <b>points = 4</b></p> <p>___ 50m (170 ft) of relatively undisturbed vegetated areas, rocky areas, or open water &gt; 95% circumference ..... <b>points = 4</b></p> <p>___ 100m (330 ft) of relatively undisturbed vegetated areas, rocky areas, or open water &gt; 25% circumference ..... <b>points = 3</b></p> <p>___ 50m (170 ft) of relatively undisturbed vegetated areas, rocky areas, or open water for &gt; 50% circumference ..... <b>points = 3</b></p> <p><b>If buffer does not meet any of the criteria above:</b></p> <p>___ No paved areas (except paved trails) or buildings within 25m (80 ft) of wetland &gt; 95% circumference. Light to moderate grazing or lawns are OK ..... <b>points = 2</b></p> <p>___ No paved areas of buildings within 50m of wetland for &gt; 50% circumference. Light to moderate grazing or lawns are OK..... <b>points = 2</b></p> <p>___ Heavy grazing in buffer ..... <b>points = 1</b></p> <p>___ Vegetated buffers are &lt; 2m wide (6.6 ft) for more than 95% circumference (e.g. tilled fields, paving, basalt bedrock extend to edge of wetland) ..... <b>points = 0</b></p> <p><b>X</b> <u>Buffer does not meet any of the criteria above</u> ..... <b>points = 1</b></p> <p style="text-align: right;"><b>Arial photo showing buffers</b></p>	<p><b>Figure</b> ____</p> <p style="text-align: center;">1</p>
	<p>H 2.2 <b>Corridors and Connections</b> (see p. 81)</p> <p>H 2.2.1 Is the wetland part of a relatively undisturbed and unbroken vegetated corridor (either riparian or upland) that is at least 150 ft. wide, has at least a 30% cover of shrubs, forest or native undisturbed prairie, that connects to estuaries, other wetlands or undisturbed uplands that are at least 250 acres in size? (<i>Dams in riparian corridors, heavily used gravel roads, paved roads, are considered breaks in the corridor.</i>)</p> <p style="text-align: center;">YES = <b>4 points</b> (go to H 2.3)                      <b>NO = go to H 2.2.2</b></p> <p>H. 2.2.2 Is the wetland part of a relatively undisturbed and unbroken vegetated corridor (either riparian or upland) that is at least 50 ft. wide, has at least 30% cover of shrubs or forest, and connects to estuaries, other wetlands or undisturbed uplands that are at least 25 acres in size? <b>OR a Lake-fringe</b> wetland, if it does not have an undisturbed corridor as in the question above?</p> <p style="text-align: center;"><b>YES = 2 points</b> (go to H 2.3)                      NO = go to H 2.2.3</p> <p>H. 2.2.3 Is the wetland:</p> <ul style="list-style-type: none"> <li>• Within 5 mi (8km) of a brackish or salt water estuary OR</li> <li>• Within 3 miles of a large field or pasture (&gt; 40 acres) OR                      YES = 1 point</li> <li>• Within 1 mile of a lake greater than 20 acres?                                      NO = 0 points</li> </ul>	<p style="text-align: center;">2</p>

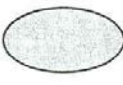
**Comments:**

	<p>H 2.3 <u>Near or adjacent to other priority habitats listed by WDFW</u> (see p. 82): (see new and complete descriptions of WDFW priority habitats, and the counties in which they can be found, in the PHS report <a href="http://wdfw.wa.gov/hab/phslist.htm">http://wdfw.wa.gov/hab/phslist.htm</a>)</p> <p>Which of the following priority habitats are within 330 ft. (100m) of the wetland unit?  <i>NOTE: the connections do not have to be relatively undisturbed.</i></p> <p><input type="checkbox"/> <b>Aspen Stands:</b> Pure or mixed stands of aspen greater than 0.4 ha (1 acre).</p> <p><input type="checkbox"/> <b>Biodiversity Areas and Corridors:</b> Areas of habitat that are relatively important to various species of native fish and wildlife (full descriptions in WDFW PHS report p. 152).</p> <p><input type="checkbox"/> <b>Herbaceous Balds:</b> Variable size patches of grass and forbs on shallow soils over bedrock.</p> <p><input type="checkbox"/> <b>Old-growth/Mature forests:</b> (Old-growth west of Cascade crest) Stands of at least 2 tree species, forming a multi-layered canopy with occasional small openings; with at least 20 trees/ha (8 trees/acre) &gt; 81 cm (32 in) dbh or &gt; 200 years of age. (Mature forests) Stands with average diameters exceeding 53 cm (21 in) dbh; crown cover may be less than 100%; decay, decadence, numbers of snags, and quantity of large downed material is generally less than that found in old-growth; 80 - 200 years old west of the Cascade crest.</p> <p><input type="checkbox"/> <b>Oregon white Oak:</b> Woodlands Stands of pure oak or oak/conifer associations where canopy coverage of the oak component is important (full descriptions in WDFW PHS report p. 158).</p> <p><input checked="" type="checkbox"/> <b>Riparian:</b> The area adjacent to aquatic systems with flowing water that contains elements of both aquatic and terrestrial ecosystems which mutually influence each other.</p> <p><input type="checkbox"/> <b>Westside Prairies:</b> Herbaceous, non-forested plant communities that can either take the form of a dry prairie or a wet prairie (full descriptions in WDFW PHS report p. 161).</p> <p><input checked="" type="checkbox"/> <b>Instream:</b> The combination of physical, biological, and chemical processes and conditions that interact to provide functional life history requirements for instream fish and wildlife resources.</p> <p><input type="checkbox"/> <b>Nearshore:</b> Relatively undisturbed nearshore habitats. These include Coastal Nearshore, Open Coast Nearshore, and Puget Sound Nearshore. (full descriptions of habitats and the definition of relatively undisturbed are in WDFW report: pp. 167-169 and glossary in Appendix A).</p> <p><input type="checkbox"/> <b>Caves:</b> A naturally occurring cavity, recess, void, or system of interconnected passages under the earth in soils, rock, ice, or other geological formations and is large enough to contain a human.</p> <p><input type="checkbox"/> <b>Cliffs:</b> Greater than 7.6 m (25 ft) high and occurring below 5000 ft.</p> <p><input type="checkbox"/> <b>Talus:</b> Homogenous areas of rock rubble ranging in average size 0.15 - 2.0 m (0.5 - 6.5 ft), composed of basalt, andesite, and/or sedimentary rock, including riprap slides and mine tailings. May be associated with cliffs.</p> <p><input type="checkbox"/> <b>Snags and Logs:</b> Trees are considered snags if they are dead or dying and exhibit sufficient decay characteristics to enable cavity excavation/use by wildlife. Priority snags have a diameter at breast height of &gt; 51 cm (20 in) in western Washington and are &gt; 2 m (6.5 ft) in height. Priority logs are &gt; 30 cm (12 in) in diameter at the largest end, and &gt; 6 m (20 ft) long.</p> <p>If wetland has <b>3 or more</b> priority habitats = <b>4 points</b>  <b>If wetland has 2</b> priority habitats = <b>3 points</b>                  If wetland has <b>1</b> priority habitat = <b>1 point</b>                      No habitats = 0 points</p> <p>Note: All vegetated wetlands are by definition a priority habitat but are not included in this list. Nearby wetlands are addressed in question H 2.4)</p>	3
	<p>H 2.4 <u>Wetland Landscape:</u> Choose the <b>one</b> description of the landscape around the wetland that best fits (see p. 84)</p> <ul style="list-style-type: none"> <li>• There are at least 3 other wetlands within 1/2 mile, and the connections between them are relatively undisturbed (light grazing between wetlands OK, as is lake shore with some boating, but connections should NOT be bisected by paved roads, fill, fields, or other development.....points = 5</li> <li>• The wetland is Lake-fringe on a lake with little disturbance and there are 3 other lake-fringe wetlands within 1/2 mile .....points = 5</li> <li>• <b>There are at least 3 other wetlands within 1/2 mile, BUT the connections between them are disturbed.....points = 3</b></li> <li>• The wetland fringe on a lake <b>with</b> disturbance and there are 3 other lake-fringe wetlands within 1/2 mile .....points = 3</li> <li>• There is at least 1 wetland within 1/2 mile .....points = 2</li> <li>• There are no wetlands within 1/2 mile.....points = 0</li> </ul>	3
<p><b>H 2 TOTAL Score</b> – opportunity for providing habitat                      <i>Add the scores from H2.1, H2.2, H2.3, H2.4</i></p>		9
<p style="text-align: right;"><i>TOTAL for H 1 from page 8</i></p>		3
◆	<p><b>Total Score for Habitat Functions</b>                      Add the points for H 1 and H 2; then <b>record the result on p. 1</b></p>	12

Comments:

Wetland name or number 21B

**WETLAND RATING FORM – WESTERN WASHINGTON**  
Version 2 – Updated July 2006 to increase accuracy and reproducibility among users  
Updated Oct. 2008 with the new WDFW definitions for priority habitats

Name of wetland (if known): 21B Date of site visit: 09-12-13

Rated by: Colin Worsley / Matt Maynard Trained by Ecology? Yes X No      Date of training: 11-2005 / 04-2006

SEC: 06 TOWNSHIP: 24N RANGE: 06E Is S/T/R in Appendix D? Yes      No X

Map of wetland unit: Figure      Estimated size 0.08 acre

**SUMMARY OF RATING**

Category based on FUNCTIONS provided by wetland: I      II      III X IV     

Category I =	Score > 70
Category II =	Score 51 - 69
Category III =	Score 30 – 50
Category IV =	Score < 30

Score for Water Quality Functions	14
Score for Hydrologic Functions	10
Score for Habitat Functions	15
<b>TOTAL Score for Functions</b>	<b>39</b>

Category based on SPECIAL CHARACTERISTICS of Wetland I      II      Does not apply X

**Final Category** (choose the “highest” category from above”) **III**

**Summary of basic information about the wetland unit.**

Wetland Unit has Special Characteristics		Wetland HGM Class used for Rating	
<b>Estuarine</b>		<b>Depressional</b>	<b>X</b>
<b>Natural Heritage Wetland</b>		<b>Riverine</b>	
<b>Bog</b>		<b>Lake-fringe</b>	
<b>Mature Forest</b>		<b>Slope</b>	
<b>Old Growth Forest</b>		<b>Flats</b>	
<b>Coastal Lagoon</b>		<b>Freshwater Tidal</b>	
<b>Interdunal</b>			
None of the above	X	Check if unit has multiple HGM classes present	

**Does the wetland being rated meet any of the criteria below?** If you answer YES to any of the questions below you will need to protect the wetland according to the regulations regarding the special characteristics found in the wetland.

Check List for Wetlands that Need Additional Protection (in addition to the protection recommended for its category)		YES	NO
SP1. <i>Has the wetland unit been documented as a habitat for any Federally listed Threatened or Endangered <b>animal or plant</b> species (T/E species)?</i> For the purposes of this rating system, “documented” means the wetland is on the appropriate state or federal database.			X
SP2. <i>Has the wetland unit been documented as habitat for any State listed Threatened or Endangered <b>animal</b> species?</i> For the purposes of this rating system, “documented” means the wetland is on the appropriate state database. Note: Wetlands with State listed plant species are categorized as Category 1 Natural Heritage Wetlands (see p. 19 of data form).			X
SP3. <i>Does the wetland unit contain individuals of Priority species listed by the WDFW for the state?</i>			X
SP4. <i>Does the wetland unit have a local significance in addition to its functions?</i> For example, the wetland has been identified in the Shoreline Master Program, the Critical Areas Ordinance, or in a local management plan as having special significance.			X

To complete the next part of the data sheet you will need to determine the Hydrogeomorphic Class of the wetland being rated.

Exhibit 16  
SSDP2016-00415  
001039

The hydrogeomorphic classification groups wetlands in to those that function in similar ways. This simplifies the questions needed to answer how well the wetland functions. The Hydrogeomorphic Class of a wetland can be determined using the key below. See p. 24 for more detailed instructions on classifying wetlands.  
Wetland Rating Form – Western Washington, Version 2 (7/06), updated with new WDFW definitions Oct. 2008

### Classification of Vegetated Wetlands for Western Washington

If the hydrologic criteria listed in each question do not apply to the entire unit being rated, you probably have a unit with multiple HGM classes. In this case, identify which hydrologic criteria in questions 1-7 apply, and go to Question 8.

1. Are the water levels in the entire unit usually controlled by tides (i.e. except during floods)?  
NO – go to 2                      **YES – the wetland class is Tidal Fringe**  
 If yes, is the salinity of the water during periods of annual low flow below 0.5 ppt (parts per thousand)?  
**YES – Freshwater Tidal Fringe**                      **NO – Saltwater Tidal Fringe (Estuarine)**  
*If your wetland can be classified as a Freshwater Tidal Fringe use the forms for Riverine wetlands. If it is a Saltwater Tidal Fringe it is rated as an Estuarine wetland. Wetlands that were call estuarine in the first and second editions of the rating system are called Salt Water Tidal Fringe in the Hydrogeomorphic Classification. Estuarine wetlands were categorized separately in the earlier editions, and this separation is being kept in this revision. To maintain consistency between editions, the term “Estuarine” wetland is kept. Please note, however, that the characteristics that define Category I and II estuarine wetlands have changed (see p. \_\_\_\_).*

---

2. The entire wetland unit is flat and precipitation is only source (>90%) of water to it. Groundwater and surface water runoff are NOT sources of water to the unit.  
NO – go to 3                      **YES – The wetland class is Flats**  
 If your wetland can be classified as a “Flats” wetland, use the form for **Depressional** wetlands.

---

3. Does the entire wetland meet both of the following criteria?  
 \_\_\_\_\_ The vegetated part of the wetland is on the shores of a body of permanent open water (without any vegetation on the surface) where at least 20 acres (8ha) in size;  
 \_\_\_\_\_ At least 30% of the open water area is deeper than 6.6 (2 m)?  
NO – go to 4                      **YES – The wetland class is Lake-fringe (Lacustrine Fringe)**

---

4. Does the entire wetland meet all of the following criteria?  
 \_\_\_\_\_ The wetland is on a slope (*slope can be very gradual*).  
 \_\_\_\_\_ The water flows through the wetland in one direction (unidirectional) and usually comes from seeps. It may flow subsurface, as sheetflow, or in a swale without distinct banks.  
 \_\_\_\_\_ The water leaves the wetland **without being impounded**?  
 NOTE: *Surface water does not pond in these types of wetlands except occasionally in very small and shallow depressions or behind hummocks (depressions are usually <3 ft diameter and less than 1 foot deep).*  
NO – go to 5                      **YES – The wetland class is Slope**

---

5. Does the entire wetland meet all of the following criteria?  
 \_\_\_\_\_ The unit is in a valley or stream channel where it gets inundated by overbank flooding from that stream or river.  
 \_\_\_\_\_ The overbank flooding occurs at least once every two years.  
 NOTE: *The riverine unit can contain depressions that are filled with water when the river is not flooding..*  
NO – go to 6                      **YES – The wetland class is Riverine**

---

6. Is the entire wetland unit in a topographic depression in which water ponds, or is saturated to the surface, at some time of the year. This means that any outlet, if present is higher than the interior of the wetland.  
NO – go to 7                      **YES – The wetland class is Depressional**

---

7. Is the entire wetland located in a very flat area with no obvious depression and no overbank flooding. The unit does not pond surface water more than a few inches. The unit seems to be maintained by high groundwater in the area. The wetland may be ditched, but has no obvious natural outlet.  
No – go to 8                      **YES – The wetland class is Depressional**

---

8. Your wetland unit seems to be difficult to classify and probably contains several different HGM classes. For example, seeps at the base of a slope may grade into a riverine floodplain, or a small stream within a depressional wetland has a zone of flooding along its sides. GO BACK AND IDENTIFY WHICH OF THE HYDROLOGIC REGIMES DESCRIBED IN QUESTIONS 1-7 APPLY TO DIFFERENT AREAS IN THE UNIT (make a rough sketch to help you decide). Use the following table to identify the appropriate class to use for the rating system if you have several HGM classes present within your wetland. NOTE: Use this table only if the class that is recommended in the second column represents 10% or more of the total area of the wetland unit being rated. If the area of the class listed in column 2 is less than 10% of the unit, classify the wetland using the class that represents more than 90% of the total area.

HGM Classes within the wetland unit being rated	HGM Class to Use in Rating
Slope + Riverine	Riverine
Slope + Depressional	Depressional
Slope + Lake-fringe	Lake-fringe
Depressional + Riverine along stream within boundary	Depressional
Depressional + Lake-fringe	Depressional
Salt Water Tidal Fringe and any other class of freshwater wetland	Treat as ESTUARINE under wetlands with special characteristics

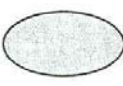
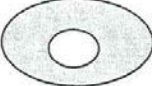

Exhibit 16  
SSDP2016-00415  
001040

If you are unable still to determine which of the above criteria apply to your wetland, or you have more than 2 HGM classes within a wetland boundary, classify the wetland as **Depressional** for the rating.

<b>D Depressional and Flat Wetlands</b>		<b>Points</b>
WATER QUALITY FUNCTIONS – Indicators that wetland functions to improve water quality.		(only 1 score per box) (see p.38)
<b>D 1</b>	<b>Does the wetland have the potential to improve water quality?</b>	
D 1.1	Characteristics of surface water flows out of the wetland: • Unit is a depression with no surface water leaving it (no outlet)..... points = 3 • Unit has an intermittently flowing, OR highly constricted, permanently flowing outlet ..... points = 2 • Unit has an unconstricted, or slightly constricted, surface outlet (permanently flowing) ..... points = 1 • Unit is a “flat” depression (Q.7 on key), or in the Flats class, with permanent surface outflow and no obvious natural outlet and/or outlet is a man-made ditch..... points = 1 (If ditch is not permanently flowing treat unit as “intermittently flowing”) <b>Provide photo or drawing</b>	Figure ____ 2
D 1.2	The soil 2 inches below the surface (or duff layer) is clay or organic (use NRCS definitions) YES points = 4 NO points = 0	0
D 1.3	Characteristics of persistent vegetation (emergent, shrub, and/or forest Cowardin class): • Wetland has persistent, ungrazed vegetation > = 95% of area..... points = 5 • Wetland has persistent, ungrazed vegetation > = 1/2 of area..... points = 3 • Wetland has persistent, ungrazed vegetation > = 1/10 of area..... points = 1 • Wetland has persistent, ungrazed vegetation < 1/10 of area..... points = 0 <b>Map of Cowardin vegetation classes</b>	Figure ____ 5
D 1.4	Characteristics of seasonal ponding or inundation: <i>This is the area of the wetland that is ponded for at least 2 months, but dries out sometime during the year. Do not count the area that is permanently ponded. Estimate area as the average condition 5 out of 10 years.</i> • Area seasonally ponded is > 1/2 total area of wetland ..... points = 4 • Area seasonally ponded is > 1/4 total area of wetland ..... points = 2 • Area seasonally ponded is < 1/4 total area of wetland ..... points = 0 <b>Map of Hydroperiods</b>	Figure ____ 0
<b>Total for D 1</b>		Add the points in the boxes above 7
<b>D 2</b>	<b>Does the wetland have the opportunity to improve water quality?</b>	(see p. 44)
Answer YES if you know or believe there are pollutants in groundwater or surface water coming into the wetland that would otherwise reduce water quality in streams, lakes or groundwater downgradient from the wetland? <i>Note which of the following conditions provide the sources of pollutants. A unit may have pollutants coming from several sources, but any single source would qualify as opportunity.</i> <input type="checkbox"/> Grazing in the wetland or within 150 ft <input type="checkbox"/> Untreated stormwater discharges to wetland <input type="checkbox"/> Tilled fields or orchards within 150 ft. of wetland <input type="checkbox"/> A stream or culvert discharges into wetland that drains developed areas, residential areas, farmed fields, roads, or clear-cut logging <input checked="" type="checkbox"/> Residential, urban areas, golf courses are within 150 ft. of wetland <input type="checkbox"/> Wetland is fed by groundwater high in phosphorus or nitrogen <input type="checkbox"/> Other _____ YES multiplier is 2                      NO multiplier is 1		Multiplier X2
<b>◆ TOTAL – Water Quality Functions</b>		14
HYDROLOGIC FUNCTIONS – Indicators that wetland unit functions to reduce flooding and stream degradation.		
<b>D 3</b>	<b>Does the wetland have the potential to reduce flooding and erosion?</b>	(see p.46)
D 3.1	Characteristics of surface water flows out of the wetland unit • Unit is a depression with no surface water leaving it (no outlet)..... points = 4 • Unit has an intermittently flowing, OR highly constricted permanently flowing outlet ..... points = 2 • Unit is a “flat” depression (Q.7 on key) or in the Flats class, with permanent surface outflow and no obvious natural outlet and/or outlet is a man-made ditch..... points = 1 (If ditch is not permanently flowing treat unit as “intermittently flowing”) • Unit has an unconstricted, or slightly constricted, surface outlet (permanently flowing) ..... points = 0	2
D 3.2	Depth of storage during wet periods. <i>Estimate the height of ponding above the bottom of the outlet. For units with no outlet measure from the surface of permanent water or deepest part (if dry).</i> • Marks of ponding are 3 ft. or more above the surface or bottom of the outlet ..... points = 7 • The wetland is a “headwater” wetland..... points = 5 • Marks of ponding between 2 ft. to < 3 ft. from surface or bottom of outlet ..... points = 5 • Marks are at least 0.5 ft. to < 2 ft. from surface or bottom of outlet ..... points = 3 • Wetland is flat (yes to Q.2 or Q.7 on key)but has small depressions on the surface that trap water points = 1 • Marks of ponding less than 0.5 ft ..... points = 0	0
D 3.3	Contribution of wetland unit to storage in the watershed: <i>Estimate the ratio of the area of upstream basin contributing surface water to the wetland to the area of the wetland unit itself.</i> • The area of the basin is less than 10 times the area of unit..... points = 5 • The area of the basin is 10 to 100 times the area of the unit ..... points = 3 • The area of the basin is more than 100 times the area of the unit ..... points = 0 • Entire unit is in the FLATS class ..... points = 5	3
<b>Total for D 3</b>		Add the points in the boxes above 5

<b>D 4</b>	<p><b>Does the wetland have the <u>opportunity</u> to reduce flooding and erosion?</b></p> <p>Answer YES if the unit is in a location in the watershed where the flood storage, or reduction in water velocity, it provides helps protect downstream property and aquatic resources from flooding or excessive and/or erosive flows. Answer NO if the water coming into the wetland is controlled by a structure such as flood gate, tide gate, flap valve, reservoir etc. OR you estimate that more than 90% of the water in the wetland is from groundwater in areas where damaging groundwater flooding does not occur. <i>Note which of the following indicators of opportunity apply.</i></p> <p><input type="checkbox"/> Wetland is in a headwater of a river or stream that has flooding problems.</p> <p><input type="checkbox"/> Wetland drains to a river or stream that has flooding problems</p> <p><input checked="" type="checkbox"/> Wetland has no outlet and impounds surface runoff water that might otherwise flow into a river or stream that has flooding problems</p> <p><input type="checkbox"/> Other _____</p> <p><b>YES multiplier is 2</b>                      NO multiplier is 1</p>	<p>(see p. 49)</p> <p>Multiplier</p> <p><u>X2</u></p>
◆	<p><b>TOTAL – Hydrologic Functions</b>                      Multiply the score from D3 by D4; then <i>add score to table on p. 1</i></p>	<p>10</p>

Comments:

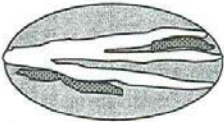
<i>These questions apply to wetlands of all HGM classes.</i> HABITAT FUNCTIONS – Indicators that wetland functions to provide important habitat.		<b>Points</b> (only 1 score per box)									
<b>H 1</b>	<b>Does the wetland have the <u>potential</u> to provide habitat for many species?</b>	<b>Figure</b> ____									
	H 1.1 <u>Vegetation structure</u> (see P. 72): Check the types of vegetation classes present (as defined by Cowardin) – Size threshold for each class is 1/4 acre or more than 10% of the area if unit is smaller than 2.5 acres. <input type="checkbox"/> Aquatic Bed <input type="checkbox"/> Emergent plants <input checked="" type="checkbox"/> Scrub/shrub (areas where shrubs have > 30% cover) <input checked="" type="checkbox"/> Forested (areas where trees have > 30% cover) If the unit has a forested class check if: <input checked="" type="checkbox"/> The forested class has 3 out of 5 strata (canopy, sub-canopy, shrubs, herbaceous, moss/ground-cover) that each cover 20% within the forested polygon. Add the number of vegetation types that qualify. If you have: <table style="margin-left: 20px;"> <tr> <td>4 structures or more.....</td> <td>points = 4</td> <td><b>Map of Cowardin vegetation classes</b></td> </tr> <tr> <td>3 structures.....</td> <td>points = 2</td> <td><b>3 structures..... points = 2</b></td> </tr> <tr> <td>2 structures.....</td> <td>points = 1</td> <td>1 structure..... points = 0</td> </tr> </table>	4 structures or more.....	points = 4	<b>Map of Cowardin vegetation classes</b>	3 structures.....	points = 2	<b>3 structures..... points = 2</b>	2 structures.....	points = 1	1 structure..... points = 0	2
4 structures or more.....	points = 4	<b>Map of Cowardin vegetation classes</b>									
3 structures.....	points = 2	<b>3 structures..... points = 2</b>									
2 structures.....	points = 1	1 structure..... points = 0									
	H 1.2 <u>Hydroperiods</u> (see p.73): Check the types of water regimes (hydroperiods) present within the wetland. The water regime has to cover more than 10% of the wetland or 1/4 acre to count (see text for descriptions of hydroperiods). <input checked="" type="checkbox"/> Permanently flooded or inundated <input type="checkbox"/> Seasonally flooded or inundated <input checked="" type="checkbox"/> Occasionally flooded or inundated <input checked="" type="checkbox"/> Saturated only <input checked="" type="checkbox"/> Permanently flowing stream or river in, or adjacent to, the wetland <input type="checkbox"/> Seasonally flowing stream in, or adjacent to, the wetland <input type="checkbox"/> <b>Lake-fringe wetland..... = 2 points</b> <input type="checkbox"/> <b>Freshwater tidal wetland..... = 2 points</b>	3									
	H 1.3 <u>Richness of Plant Species</u> (see p. 75): Count the number of plant species in the wetland that cover at least 10 ft <sup>2</sup> (different patches of the same species can be combined to meet the size threshold) You do not have to name the species. Do not include Eurasian Milfoil, reed canarygrass, purple loosestrife, Canadian Thistle. If you counted: <table style="margin-left: 20px;"> <tr> <td>&gt; 19 species .....</td> <td>points = 2</td> </tr> <tr> <td><b>5 – 19 species.....</b></td> <td><b>points = 1</b></td> </tr> <tr> <td>&lt; 5 species .....</td> <td>points = 0</td> </tr> </table> List species below if you want to: _____ _____ _____	> 19 species .....	points = 2	<b>5 – 19 species.....</b>	<b>points = 1</b>	< 5 species .....	points = 0	1			
> 19 species .....	points = 2										
<b>5 – 19 species.....</b>	<b>points = 1</b>										
< 5 species .....	points = 0										
	H 1.4 <u>Interspersion of Habitats</u> (see p. 76): Decided from the diagrams below whether interspersion between Cowardin vegetation (described in H1.1), or the classes and unvegetated areas (can include open water or mudflats) is high, medium, low, or none. <div style="display: flex; justify-content: space-around; align-items: flex-start;"> <div style="text-align: center;">                           None = 0 points                     </div> <div style="text-align: center;">                           Low = 1 point                     </div> <div style="text-align: center;">                           Moderate = 2 points                     </div> <div style="text-align: center;">                           High = 3 points                     </div> </div> <div style="margin-left: 20px;">                           [riparian braided channels]                     </div> <div style="margin-left: 20px;"> <p>Note: If you have 4 or more classes or 3 vegetation classes and open water, the rating is always “high”.</p> <p><b>Use map of Cowardin classes.</b></p> </div>	1									
	H 1.5 <u>Special Habitat Features</u> (see p. 77): Check the habitat features that are present in the wetland. The number of checks is the number of points you put into the next column. <ul style="list-style-type: none"> <li><input type="checkbox"/> Large, downed, woody debris within the wetland (&gt; 4 in. diameter and 6 ft. long)</li> <li><input type="checkbox"/> Standing snags (diameter at the bottom &gt; 4 inches) in the wetland</li> <li><input type="checkbox"/> Undercut banks are present for at least 6.6 ft. (2m) and/or overhanging vegetation extends at least 3.3 ft. (1m) over a stream (or ditch) in, or contiguous with the unit, for at least 33 ft. (10m)</li> <li><input type="checkbox"/> Stable steep banks of fine material that might be used by beaver or muskrat for denning (&gt; 30 degree slope) OR signs of recent beaver activity are present (cut shrubs or trees that have not yet turned grey/brown)</li> <li><input type="checkbox"/> At least 1/4 acre of thin-stemmed persistent vegetation or woody branches are present in areas that are permanently or seasonally inundated (structures for egg-laying by amphibians)</li> <li><input type="checkbox"/> Invasive plants cover less than 25% of the wetland area in each stratum of plants</li> </ul> NOTE: The 20% stated in early printings of the manual on page 78 is an error.	0									
<b>H 1 TOTAL Score</b> – potential for providing habitat		Add the points in the column. <div style="float: right; color: red; font-weight: bold;">                         Exhibit 16                          SSDP2016-00415                          001043                     </div>									





	<p>H 2.3 <u>Near or adjacent to other priority habitats listed by WDFW</u> (see p. 82): (see new and complete descriptions of WDFW priority habitats, and the counties in which they can be found, in the PHS report <a href="http://wdfw.wa.gov/hab/phslist.htm">http://wdfw.wa.gov/hab/phslist.htm</a>)</p> <p>Which of the following priority habitats are within 330 ft. (100m) of the wetland unit?  <i>NOTE: the connections do not have to be relatively undisturbed.</i></p> <p><input type="checkbox"/> <b>Aspen Stands:</b> Pure or mixed stands of aspen greater than 0.4 ha (1 acre).</p> <p><input type="checkbox"/> <b>Biodiversity Areas and Corridors:</b> Areas of habitat that are relatively important to various species of native fish and wildlife (full descriptions in WDFW PHS report p. 152).</p> <p><input type="checkbox"/> <b>Herbaceous Balds:</b> Variable size patches of grass and forbs on shallow soils over bedrock.</p> <p><input type="checkbox"/> <b>Old-growth/Mature forests:</b> (Old-growth west of Cascade crest) Stands of at least 2 tree species, forming a multi-layered canopy with occasional small openings; with at least 20 trees/ha (8 trees/acre) &gt; 81 cm (32 in) dbh or &gt; 200 years of age. (Mature forests) Stands with average diameters exceeding 53 cm (21 in) dbh; crown cover may be less than 100%; decay, decadence, numbers of snags, and quantity of large downed material is generally less than that found in old-growth; 80 - 200 years old west of the Cascade crest.</p> <p><input type="checkbox"/> <b>Oregon white Oak:</b> Woodlands Stands of pure oak or oak/conifer associations where canopy coverage of the oak component is important (full descriptions in WDFW PHS report p. 158).</p> <p><input checked="" type="checkbox"/> <b>Riparian:</b> The area adjacent to aquatic systems with flowing water that contains elements of both aquatic and terrestrial ecosystems which mutually influence each other.</p> <p><input type="checkbox"/> <b>Westside Prairies:</b> Herbaceous, non-forested plant communities that can either take the form of a dry prairie or a wet prairie (full descriptions in WDFW PHS report p. 161).</p> <p><input checked="" type="checkbox"/> <b>Instream:</b> The combination of physical, biological, and chemical processes and conditions that interact to provide functional life history requirements for instream fish and wildlife resources.</p> <p><input type="checkbox"/> <b>Nearshore:</b> Relatively undisturbed nearshore habitats. These include Coastal Nearshore, Open Coast Nearshore, and Puget Sound Nearshore. (full descriptions of habitats and the definition of relatively undisturbed are in WDFW report: pp. 167-169 and glossary in Appendix A).</p> <p><input type="checkbox"/> <b>Caves:</b> A naturally occurring cavity, recess, void, or system of interconnected passages under the earth in soils, rock, ice, or other geological formations and is large enough to contain a human.</p> <p><input type="checkbox"/> <b>Cliffs:</b> Greater than 7.6 m (25 ft) high and occurring below 5000 ft.</p> <p><input type="checkbox"/> <b>Talus:</b> Homogenous areas of rock rubble ranging in average size 0.15 - 2.0 m (0.5 - 6.5 ft), composed of basalt, andesite, and/or sedimentary rock, including riprap slides and mine tailings. May be associated with cliffs.</p> <p><input type="checkbox"/> <b>Snags and Logs:</b> Trees are considered snags if they are dead or dying and exhibit sufficient decay characteristics to enable cavity excavation/use by wildlife. Priority snags have a diameter at breast height of &gt; 51 cm (20 in) in western Washington and are &gt; 2 m (6.5 ft) in height. Priority logs are &gt; 30 cm (12 in) in diameter at the largest end, and &gt; 6 m (20 ft) long.</p> <p>If wetland has <b>3 or more</b> priority habitats = <b>4 points</b>  <b>If wetland has 2</b> priority habitats = <b>3 points</b>                  If wetland has <b>1</b> priority habitat = <b>1 point</b>                      No habitats = 0 points</p> <p>Note: All vegetated wetlands are by definition a priority habitat but are not included in this list. Nearby wetlands are addressed in question H 2.4)</p>	3
	<p>H 2.4 <u>Wetland Landscape:</u> Choose the <b>one</b> description of the landscape around the wetland that best fits (see p. 84)</p> <ul style="list-style-type: none"> <li>• There are at least 3 other wetlands within 1/2 mile, and the connections between them are relatively undisturbed (light grazing between wetlands OK, as is lake shore with some boating, but connections should NOT be bisected by paved roads, fill, fields, or other development.....points = 5</li> <li>• The wetland is Lake-fringe on a lake with little disturbance and there are 3 other lake-fringe wetlands within 1/2 mile .....points = 5</li> <li>• <b>There are at least 3 other wetlands within 1/2 mile, BUT the connections between them are disturbed.....points = 3</b></li> <li>• The wetland fringe on a lake <b>with</b> disturbance and there are 3 other lake-fringe wetlands within 1/2 mile .....points = 3</li> <li>• There is at least 1 wetland within 1/2 mile .....points = 2</li> <li>• There are no wetlands within 1/2 mile.....points = 0</li> </ul>	3
<p><b>H 2 TOTAL Score</b> – opportunity for providing habitat                      Add the scores from H2.1, H2.2, H2.3, H2.4</p>		8
<p style="text-align: right;"><i>TOTAL for H 1 from page 8</i></p>		7
◆	<p><b>Total Score for Habitat Functions</b>                      Add the points for H 1 and H 2; then <b>record the result on p. 1</b></p>	15

Comments:



<p><b>SC4</b></p>	<p><b>Forested Wetlands</b> (see p. 90)                  Does the wetland have at least 1 acre of forest that meet one of these criteria for the Department of Fish and Wildlife's forests as priority habitats? <i>If you answer yes you will still need to rate the wetland based on its function.</i>                  ___ <b>Old-growth forests:</b> (west of Cascade Crest) Stands of at least two three species forming a multi-layered canopy with occasional small openings; with at least 8 trees/acre (20 trees/hectare) that are at least 200 years of age OR have a diameter at breast height (dbh) of 32 inches (81 cm or more).                  NOTE: The criterion for dbh is based on measurements for upland forests. Two-hundred year old trees in wetlands will often have a smaller dbh because their growth rates are often slower. The DFW criterion is and "OR" so old-growth forests do not necessarily have to have trees of this diameter.                  ___ <b>Mature forests:</b> (west of the Cascade Crest) Stands where the largest trees are 80 – 200 years old OR have an average diameters (dbh) exceeding 21 inches (53 cm); crown cover may be less than 100%; decay, decadence, numbers of snags, and quantity of large downed material is generally less than that found in old-growth.                  YES = Category I                      NO = <u>X</u> not a forested wetland with special characteristics</p>	<p><b>Cat. I</b></p>
<p><b>SC5</b></p>	<p><b>Wetlands in Coastal Lagoons</b> (see p. 91)                  Does the wetland meet all of the following criteria of a wetland in a coastal lagoon?                  ___ The wetland lies in a depression adjacent to marine waters that is wholly or partially separated from marine waters by sandbanks, gravel banks, shingle, or, less frequently, rocks.                  ___ The lagoon in which the wetland is located contains surface water that is saline or brackish (&gt; 0.5 ppt) during most of the year in at least a portion of the lagoon (<i>needs to be measured near the bottom.</i>)                  YES = Go to SC 5.1                      NO <u>X</u> not a wetland in a coastal lagoon                  SC 5.1 Does the wetland meet all of the following three conditions?                  ___ The wetland is relatively undisturbed (has no diking, ditching, filling, cultivation, grazing) and has less than 20% cover of invasive plant species (see list of invasive species on p. 74).                  ___ At least 3/4 of the landward edge of the wetland has a 100 ft. buffer of shrub, forest, or un-grazed or un-mowed grassland.                  ___ The wetland is larger than 1/10 acre (4350 square ft.)                  YES = Category I                      NO = Category II</p>	<p><b>Cat. I</b>  <b>Cat. II</b></p>
<p><b>SC6</b></p>	<p><b>Interdunal Wetlands</b> (see p. 93)                  Is the wetland west of the 1889 line (also called the Western Boundary of Upland Ownership or WBUO)?                  YES = Go to SC 6.1                      NO <u>X</u> not an interdunal wetland for rating  <i>If you answer yes you will still need to rate the wetland based on its functions.</i>                  In practical terms that means the following geographic areas:                  • Long Beach Peninsula -- lands west of SR 103                  • Grayland-Westport -- lands west of SR 105                  • Ocean Shores-Copalis – lands west of SR 115 and SR 109                  SC 6.1 Is the wetland one acre or larger, or is it in a mosaic of wetlands that is one acre or larger?                  YES = Category II                      NO = go to SC 6.2                  SC 6.2 Is the wetland between 0.1 and 1 acre, or is it in a mosaic of wetlands that is between 0.1 and 1 acre?                  YES = Category III</p>	<p><b>Cat. II</b>  <b>Cat. III</b></p>
<p>◆</p>	<p><b>Category of wetland based on Special Characteristics</b>                  Choose the "highest" rating if wetland falls into several categories, and record on p. 1.                  If you answered NO for all types enter "Not Applicable" on p. 1</p>	<p><b>NA</b></p>

Comments:

Wetland name or number 21D

**WETLAND RATING FORM – WESTERN WASHINGTON**  
Version 2 – Updated July 2006 to increase accuracy and reproducibility among users  
Updated Oct. 2008 with the new WDFW definitions for priority habitats

Name of wetland (if known): 21D Date of site visit: 09-20-13

Rated by: Colin Worsley / Matt Maynard Trained by Ecology? Yes X No      Date of training: 11-2005 / 04-2006

SEC: 06 TOWNSHIP: 24N RANGE: 06E Is S/T/R in Appendix D? Yes      No X

Map of wetland unit: Figure      Estimated size 0.15 acre

**SUMMARY OF RATING**

Category based on FUNCTIONS provided by wetland: I      II      III      IV X

Category I =	Score > 70
Category II =	Score 51 - 69
Category III =	Score 30 – 50
Category IV =	Score < 30

Score for Water Quality Functions	2
Score for Hydrologic Functions	6
Score for Habitat Functions	10
<b>TOTAL Score for Functions</b>	<b>18</b>

Category based on SPECIAL CHARACTERISTICS of Wetland I      II      Does not apply X

**Final Category** (choose the “highest” category from above”) **IV**

**Summary of basic information about the wetland unit.**

Wetland Unit has Special Characteristics		Wetland HGM Class used for Rating	
<b>Estuarine</b>		<b>Depressional</b>	<b>X</b>
<b>Natural Heritage Wetland</b>		<b>Riverine</b>	
<b>Bog</b>		<b>Lake-fringe</b>	
<b>Mature Forest</b>		<b>Slope</b>	(x)
<b>Old Growth Forest</b>		<b>Flats</b>	
<b>Coastal Lagoon</b>		<b>Freshwater Tidal</b>	
<b>Interdunal</b>			
None of the above	X	Check if unit has multiple HGM classes present	<b>X</b>

**Does the wetland being rated meet any of the criteria below?** If you answer YES to any of the questions below you will need to protect the wetland according to the regulations regarding the special characteristics found in the wetland.

Check List for Wetlands that Need Additional Protection (in addition to the protection recommended for its category)	YES	NO
SP1. <i>Has the wetland unit been documented as a habitat for any Federally listed Threatened or Endangered <b>animal or plant</b> species (T/E species)?</i> For the purposes of this rating system, “documented” means the wetland is on the appropriate state or federal database.		X
SP2. <i>Has the wetland unit been documented as habitat for any State listed Threatened or Endangered <b>animal</b> species?</i> For the purposes of this rating system, “documented” means the wetland is on the appropriate state database. Note: Wetlands with State listed plant species are categorized as Category 1 Natural Heritage Wetlands (see p. 19 of data form).		X
SP3. <i>Does the wetland unit contain individuals of Priority species listed by the WDFW for the state?</i>		X
SP4. <i>Does the wetland unit have a local significance in addition to its functions?</i> For example, the wetland has been identified in the Shoreline Master Program, the Critical Areas Ordinance, or in a local management plan as having special significance.		X

To complete the next part of the data sheet you will need to determine the Hydrogeomorphic Class of the wetland being rated.

Exhibit 16  
SSDP2016-00415  
001048

### Classification of Vegetated Wetlands for Western Washington

If the hydrologic criteria listed in each question do not apply to the entire unit being rated, you probably have a unit with multiple HGM classes. In this case, identify which hydrologic criteria in questions 1-7 apply, and go to Question 8.

1. Are the water levels in the entire unit usually controlled by tides (i.e. except during floods)?  
NO – go to 2                      **YES – the wetland class is Tidal Fringe**  
 If yes, is the salinity of the water during periods of annual low flow below 0.5 ppt (parts per thousand)?  
**YES – Freshwater Tidal Fringe**                      **NO – Saltwater Tidal Fringe (Estuarine)**  
*If your wetland can be classified as a Freshwater Tidal Fringe use the forms for Riverine wetlands. If it is a Saltwater Tidal Fringe it is rated as an Estuarine wetland. Wetlands that were call estuarine in the first and second editions of the rating system are called Salt Water Tidal Fringe in the Hydrogeomorphic Classification. Estuarine wetlands were categorized separately in the earlier editions, and this separation is being kept in this revision. To maintain consistency between editions, the term “Estuarine” wetland is kept. Please note, however, that the characteristics that define Category I and II estuarine wetlands have changed (see p. \_\_\_\_\_).*

---

2. The entire wetland unit is flat and precipitation is only source (>90%) of water to it. Groundwater and surface water runoff are NOT sources of water to the unit.  
NO – go to 3                      **YES – The wetland class is Flats**  
 If your wetland can be classified as a “Flats” wetland, use the form for **Depressional** wetlands.

---

3. Does the entire wetland meet both of the following criteria?  
 \_\_\_\_\_ The vegetated part of the wetland is on the shores of a body of permanent open water (without any vegetation on the surface) where at least 20 acres (8ha) in size;  
 \_\_\_\_\_ At least 30% of the open water area is deeper than 6.6 (2 m)?  
NO – go to 4                      **YES – The wetland class is Lake-fringe (Lacustrine Fringe)**

---

4. Does the entire wetland meet all of the following criteria?  
 \_\_\_\_\_ The wetland is on a slope (*slope can be very gradual*).  
 \_\_\_\_\_ The water flows through the wetland in one direction (unidirectional) and usually comes from seeps. It may flow subsurface, as sheetflow, or in a swale without distinct banks.  
 \_\_\_\_\_ The water leaves the wetland **without being impounded**?  
 NOTE: *Surface water does not pond in these types of wetlands except occasionally in very small and shallow depressions or behind hummocks (depressions are usually <3 ft diameter and less than 1 foot deep).*  
NO – go to 5                      **YES – The wetland class is Slope**

---

5. Does the entire wetland meet all of the following criteria?  
 \_\_\_\_\_ The unit is in a valley or stream channel where it gets inundated by overbank flooding from that stream or river.  
 \_\_\_\_\_ The overbank flooding occurs at least once every two years.  
 NOTE: *The riverine unit can contain depressions that are filled with water when the river is not flooding..*  
NO – go to 6                      **YES – The wetland class is Riverine**

---

6. Is the entire wetland unit in a topographic depression in which water ponds, or is saturated to the surface, at some time of the year. This means that any outlet, if present is higher than the interior of the wetland.  
NO – go to 7                      **YES – The wetland class is Depressional**

---

7. Is the entire wetland located in a very flat area with no obvious depression and no overbank flooding. The unit does not pond surface water more than a few inches. The unit seems to be maintained by high groundwater in the area. The wetland may be ditched, but has no obvious natural outlet.  
No – go to 8                      **YES – The wetland class is Depressional**

---

8. Your wetland unit seems to be difficult to classify and probably contains several different HGM classes. For example, seeps at the base of a slope may grade into a riverine floodplain, or a small stream within a depressional wetland has a zone of flooding along its sides. **GO BACK AND IDENTIFY WHICH OF THE HYDROLOGIC REGIMES DESCRIBED IN QUESTIONS 1-7 APPLY TO DIFFERENT AREAS IN THE UNIT** (make a rough sketch to help you decide). Use the following table to identify the appropriate class to use for the rating system if you have several HGM classes present within your wetland. NOTE: Use this table only if the class that is recommended in the second column represents 10% or more of the total area of the wetland unit being rated. If the area of the class listed in column 2 is less than 10% of the unit, classify the wetland using the class that represents more than 90% of the total area.

HGM Classes within the wetland unit being rated	HGM Class to Use in Rating
Slope + Riverine	Riverine
Slope + Depressional	Depressional
Slope + Lake-fringe	Lake-fringe
Depressional + Riverine along stream within boundary	Depressional
Depressional + Lake-fringe	Depressional
Salt Water Tidal Fringe and any other class of freshwater wetland	Treat as ESTUARINE under wetlands with special characteristics

**Exhibit 16**  
**SSDP2016-00415**  
**001049**

If you are unable still to determine which of the above criteria apply to your wetland, or you have more than 2 HGM classes within a wetland boundary, classify the wetland as **Depressional** for the rating.



<b>D 4</b>	<p><b>Does the wetland have the <u>opportunity</u> to reduce flooding and erosion?</b></p> <p>Answer YES if the unit is in a location in the watershed where the flood storage, or reduction in water velocity, it provides helps protect downstream property and aquatic resources from flooding or excessive and/or erosive flows. Answer NO if the water coming into the wetland is controlled by a structure such as flood gate, tide gate, flap valve, reservoir etc. OR you estimate that more than 90% of the water in the wetland is from groundwater in areas where damaging groundwater flooding does not occur. <i>Note which of the following indicators of opportunity apply.</i></p> <p><input type="checkbox"/> Wetland is in a headwater of a river or stream that has flooding problems.</p> <p><input type="checkbox"/> Wetland drains to a river or stream that has flooding problems</p> <p><input checked="" type="checkbox"/> Wetland has no outlet and impounds surface runoff water that might otherwise flow into a river or stream that has flooding problems</p> <p><input type="checkbox"/> Other _____</p> <p><b>YES multiplier is 2</b>                      NO multiplier is 1</p>	<p>(see p. 49)</p> <p>Multiplier</p> <p><u>X2</u></p>
◆	<p><b>TOTAL – Hydrologic Functions</b>                      Multiply the score from D3 by D4; then <i>add score to table on p. 1</i></p>	<p><b>6</b></p>

Comments:







<p><i>These questions apply to wetlands of all HGM classes.</i></p> <p>HABITAT FUNCTIONS – Indicators that wetland functions to provide important habitat.</p>		<p><b>Points</b> (only 1 score per box)</p>
<b>H 1</b>	<b>Does the wetland have the <u>potential</u> to provide habitat for many species?</b>	
H 1.1	<p><u>Vegetation structure</u> (see P. 72):                      Check the types of vegetation classes present (as defined by Cowardin) – Size threshold for each class is 1/4 acre or more than 10% of the area if unit is smaller than 2.5 acres.</p> <p><input type="checkbox"/> Aquatic Bed  <input checked="" type="checkbox"/> Emergent plants  <input type="checkbox"/> Scrub/shrub (areas where shrubs have &gt; 30% cover)  <input type="checkbox"/> Forested (areas where trees have &gt; 30% cover)</p> <p>If the unit has a forested class check if:  <input type="checkbox"/> The forested class has 3 out of 5 strata (canopy, sub-canopy, shrubs, herbaceous, moss/ground-cover) that each cover 20% within the forested polygon.                      Add the number of vegetation types that qualify. If you have:</p> <p>4 structures or more..... points = 4                      3 structures..... points = 2                      2 structures..... points = 1</p> <p style="text-align: right;"><b>Map of Cowardin vegetation classes</b>                      3 structures..... points = 2                      1 structure..... points = 0</p>	<p><b>Figure</b> ____</p> <p style="text-align: right;">0</p>
H 1.2	<p><u>Hydroperiods</u> (see p.73):                      Check the types of water regimes (hydroperiods) present within the wetland. The water regime has to cover more than 10% of the wetland or 1/4 acre to count (see text for descriptions of hydroperiods).</p> <p><input checked="" type="checkbox"/> Permanently flooded or inundated  <input type="checkbox"/> Seasonally flooded or inundated  <input type="checkbox"/> Occasionally flooded or inundated  <input checked="" type="checkbox"/> Saturated only</p> <p><input type="checkbox"/> Permanently flowing stream or river in, or adjacent to, the wetland  <input type="checkbox"/> Seasonally flowing stream in, or adjacent to, the wetland  <input type="checkbox"/> <b>Lake-fringe wetland..... = 2 points</b>  <input type="checkbox"/> <b>Freshwater tidal wetland..... = 2 points</b></p> <p style="text-align: right;"><b>Map of hydroperiods</b></p> <p>4 or more types present points = 3                      3 or more types present..... points = 2                      2 types present..... points = 1                      1 type present ..... points = 0</p>	<p><b>Figure</b> ____</p> <p style="text-align: right;">1</p>
H 1.3	<p><u>Richness of Plant Species</u> (see p. 75):                      Count the number of plant species in the wetland that cover at least 10 ft<sup>2</sup> (different patches of the same species can be combined to meet the size threshold)                      You do not have to name the species. Do not include Eurasian Milfoil, reed canarygrass, purple loosestrife, Canadian Thistle.</p> <p>If you counted: &gt; 19 species ..... points = 2                      5 – 19 species..... points = 1                      &lt; 5 species ..... points = 0</p> <p>List species below if you want to:                      _____                      _____                      _____</p>	<p style="text-align: right;">1</p>
H 1.4	<p><u>Interspersion of Habitats</u> (see p. 76):                      Decided from the diagrams below whether interspersion between Cowardin vegetation (described in H1.1), or the classes and unvegetated areas (can include open water or mudflats) is high, medium, low, or none.</p> <div style="display: flex; justify-content: space-around;"> <div style="text-align: center;">                           None = 0 points                     </div> <div style="text-align: center;">                           Low = 1 point                     </div> <div style="text-align: center;">                           Moderate = 2 points                     </div> </div> <div style="display: flex; justify-content: space-around; margin-top: 20px;"> <div style="text-align: center;">                           High = 3 points                     </div> <div style="text-align: center;">                           High = 3 points                     </div> <div style="text-align: center;">                           [riparian braided channels]                     </div> </div> <p style="text-align: right;">Note: If you have 4 or more classes or 3 vegetation classes and open water, the rating is always “high”.  Use map of Cowardin classes.</p>	<p><b>Figure</b> ____</p> <p style="text-align: right;">0</p>
H 1.5	<p><u>Special Habitat Features</u> (see p. 77):                      Check the habitat features that are present in the wetland. The number of checks is the number of points you put into the next column.</p> <p><input type="checkbox"/> Large, downed, woody debris within the wetland (&gt; 4 in. diameter and 6 ft. long)  <input type="checkbox"/> Standing snags (diameter at the bottom &gt; 4 inches) in the wetland  <input type="checkbox"/> Undercut banks are present for at least 6.6 ft. (2m) and/or overhanging vegetation extends at least 3.3 ft. (1m) over a stream (or ditch) in, or contiguous with the unit, for at least 33 ft. (10m)  <input type="checkbox"/> Stable steep banks of fine material that might be used by beaver or muskrat for denning (&gt; 30 degree slope) OR signs of recent beaver activity are present (cut shrubs or trees that have not yet turned grey/brown)  <input type="checkbox"/> At least 1/4 acre of thin-stemmed persistent vegetation or woody branches are present in areas that are permanently or seasonally inundated (structures for egg-laying by amphibians)  <input type="checkbox"/> Invasive plants cover less than 25% of the wetland area in each stratum of plants</p> <p><i>NOTE: The 20% stated in early printings of the manual on page 78 is an error.</i></p>	<p style="text-align: right;">0</p>
<b>H 1 TOTAL Score</b> – potential for providing habitat		<p>Add the points in the column.</p> <p style="text-align: right;"><b>2</b></p>

Exhibit 16  
SSDP2016-00415  
001051

H 2	Does the wetland have the <u>opportunity</u> to provide habitat for many species?	(only 1 score per box)
	<p>H 2.1 <u>Buffers</u> (see P. 80):  <i>Choose the description that best represents condition of buffer of wetland unit. The highest scoring criterion that applies to the wetland is to be used in the rating. See text for definition of “undisturbed”.</i></p> <p><input type="checkbox"/> 100m (330 ft) of relatively undisturbed vegetated areas, rocky areas, or open water &gt; 95% of circumference. No structures are within the undisturbed part of buffer (relatively undisturbed also means no grazing, no landscaping, no daily human use)..... <b>points = 5</b></p> <p><input type="checkbox"/> 100m (330 ft) of relatively undisturbed vegetated areas, rocky areas, or open water &gt; 50% circumference ..... <b>points = 4</b></p> <p><input type="checkbox"/> 50m (170 ft) of relatively undisturbed vegetated areas, rocky areas, or open water &gt; 95% circumference ..... <b>points = 4</b></p> <p><input type="checkbox"/> 100m (330 ft) of relatively undisturbed vegetated areas, rocky areas, or open water &gt; 25% circumference ..... <b>points = 3</b></p> <p><input type="checkbox"/> 50m (170 ft) of relatively undisturbed vegetated areas, rocky areas, or open water for &gt; 50% circumference ..... <b>points = 3</b></p> <p><b>If buffer does not meet any of the criteria above:</b></p> <p><input type="checkbox"/> No paved areas (except paved trails) or buildings within 25m (80 ft) of wetland &gt; 95% circumference. Light to moderate grazing or lawns are OK ..... <b>points = 2</b></p> <p><input type="checkbox"/> No paved areas of buildings within 50m of wetland for &gt; 50% circumference. Light to moderate grazing or lawns are OK..... <b>points = 2</b></p> <p><input type="checkbox"/> Heavy grazing in buffer ..... <b>points = 1</b></p> <p><input type="checkbox"/> Vegetated buffers are &lt; 2m wide (6.6 ft) for more than 95% circumference (e.g. tilled fields, paving, basalt bedrock extend to edge of wetland) ..... <b>points = 0</b></p> <p><input checked="" type="checkbox"/> Buffer does not meet any of the criteria above ..... <b>points = 1</b></p> <p style="text-align: right;"><b>Arial photo showing buffers</b></p>	<p><b>Figure</b> ____</p> <p>1</p>
	<p>H 2.2 <u>Corridors and Connections</u> (see p. 81)</p> <p>H 2.2.1 Is the wetland part of a relatively undisturbed and unbroken vegetated corridor (either riparian or upland) that is at least 150 ft. wide, has at least a 30% cover of shrubs, forest or native undisturbed prairie, that connects to estuaries, other wetlands or undisturbed uplands that are at least 250 acres in size? (<i>Dams in riparian corridors, heavily used gravel roads, paved roads, are considered breaks in the corridor.</i>)</p> <p>YES = <b>4 points</b> (go to H 2.3)                      NO = go to H 2.2.2</p> <p>H. 2.2.2 Is the wetland part of a relatively undisturbed and unbroken vegetated corridor (either riparian or upland) that is at least 50 ft. wide, has at least 30% cover of shrubs or forest, and connects to estuaries, other wetlands or undisturbed uplands that are at least 25 acres in size? <b>OR a Lake-fringe wetland</b>, if it does not have an undisturbed corridor as in the question above?</p> <p>YES = <b>2 points</b> (go to H 2.3)                      NO = go to H 2.2.3</p> <p>H. 2.2.3 Is the wetland:</p> <ul style="list-style-type: none"> <li>• Within 5 mi (8km) of a brackish or salt water estuary OR</li> <li>• Within 3 miles of a large field or pasture (&gt; 40 acres) OR                      YES = 1 point</li> <li>• Within 1 mile of a lake greater than 20 acres?                                      NO = 0 points</li> </ul>	<p>1</p>

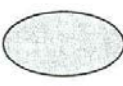
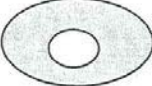
Comments:

	<p>H 2.3 <u>Near or adjacent to other priority habitats listed by WDFW</u> (see p. 82): (see new and complete descriptions of WDFW priority habitats, and the counties in which they can be found, in the PHS report <a href="http://wdfw.wa.gov/hab/phslist.htm">http://wdfw.wa.gov/hab/phslist.htm</a> )</p> <p>Which of the following priority habitats are within 330 ft. (100m) of the wetland unit?  <i>NOTE: the connections do not have to be relatively undisturbed.</i></p> <p><input type="checkbox"/> <b>Aspen Stands:</b> Pure or mixed stands of aspen greater than 0.4 ha (1 acre).</p> <p><input type="checkbox"/> <b>Biodiversity Areas and Corridors:</b> Areas of habitat that are relatively important to various species of native fish and wildlife (full descriptions in WDFW PHS report p. 152).</p> <p><input type="checkbox"/> <b>Herbaceous Balds:</b> Variable size patches of grass and forbs on shallow soils over bedrock.</p> <p><input type="checkbox"/> <b>Old-growth/Mature forests:</b> (Old-growth west of Cascade crest) Stands of at least 2 tree species, forming a multi-layered canopy with occasional small openings; with at least 20 trees/ha (8 trees/acre) &gt; 81 cm (32 in) dbh or &gt; 200 years of age. (Mature forests) Stands with average diameters exceeding 53 cm (21 in) dbh; crown cover may be less than 100%; decay, decadence, numbers of snags, and quantity of large downed material is generally less than that found in old-growth; 80 - 200 years old west of the Cascade crest.</p> <p><input type="checkbox"/> <b>Oregon white Oak:</b> Woodlands Stands of pure oak or oak/conifer associations where canopy coverage of the oak component is important (full descriptions in WDFW PHS report p. 158).</p> <p><input checked="" type="checkbox"/> <b>Riparian:</b> The area adjacent to aquatic systems with flowing water that contains elements of both aquatic and terrestrial ecosystems which mutually influence each other.</p> <p><input type="checkbox"/> <b>Westside Prairies:</b> Herbaceous, non-forested plant communities that can either take the form of a dry prairie or a wet prairie (full descriptions in WDFW PHS report p. 161).</p> <p><input checked="" type="checkbox"/> <b>Instream:</b> The combination of physical, biological, and chemical processes and conditions that interact to provide functional life history requirements for instream fish and wildlife resources.</p> <p><input type="checkbox"/> <b>Nearshore:</b> Relatively undisturbed nearshore habitats. These include Coastal Nearshore, Open Coast Nearshore, and Puget Sound Nearshore. (full descriptions of habitats and the definition of relatively undisturbed are in WDFW report: pp. 167-169 and glossary in Appendix A).</p> <p><input type="checkbox"/> <b>Caves:</b> A naturally occurring cavity, recess, void, or system of interconnected passages under the earth in soils, rock, ice, or other geological formations and is large enough to contain a human.</p> <p><input type="checkbox"/> <b>Cliffs:</b> Greater than 7.6 m (25 ft) high and occurring below 5000 ft.</p> <p><input type="checkbox"/> <b>Talus:</b> Homogenous areas of rock rubble ranging in average size 0.15 - 2.0 m (0.5 - 6.5 ft), composed of basalt, andesite, and/or sedimentary rock, including riprap slides and mine tailings. May be associated with cliffs.</p> <p><input type="checkbox"/> <b>Snags and Logs:</b> Trees are considered snags if they are dead or dying and exhibit sufficient decay characteristics to enable cavity excavation/use by wildlife. Priority snags have a diameter at breast height of &gt; 51 cm (20 in) in western Washington and are &gt; 2 m (6.5 ft) in height. Priority logs are &gt; 30 cm (12 in) in diameter at the largest end, and &gt; 6 m (20 ft) long.</p> <p>If wetland has <b>3 or more</b> priority habitats = <b>4 points</b>  <b>If wetland has 2</b> priority habitats = <b>3 points</b>                  If wetland has <b>1</b> priority habitat = <b>1 point</b>                      No habitats = 0 points</p> <p>Note: All vegetated wetlands are by definition a priority habitat but are not included in this list. Nearby wetlands are addressed in question H 2.4)</p>	3
	<p>H 2.4 <u>Wetland Landscape:</u> Choose the <b>one</b> description of the landscape around the wetland that best fits (see p. 84)</p> <ul style="list-style-type: none"> <li>• There are at least 3 other wetlands within 1/2 mile, and the connections between them are relatively undisturbed (light grazing between wetlands OK, as is lake shore with some boating, but connections should NOT be bisected by paved roads, fill, fields, or other development.....points = 5</li> <li>• The wetland is Lake-fringe on a lake with little disturbance and there are 3 other lake-fringe wetlands within 1/2 mile .....points = 5</li> <li>• <b>There are at least 3 other wetlands within 1/2 mile, BUT the connections between them are disturbed.....points = 3</b></li> <li>• The wetland fringe on a lake <b>with</b> disturbance and there are 3 other lake-fringe wetlands within 1/2 mile .....points = 3</li> <li>• There is at least 1 wetland within 1/2 mile .....points = 2</li> <li>• There are no wetlands within 1/2 mile.....points = 0</li> </ul>	3
<b>H 2 TOTAL Score – opportunity for providing habitat</b> <i>Add the scores from H2.1, H2.2, H2.3, H2.4</i>		8
<i>TOTAL for H 1 from page 8</i>		2
<b>◆</b>	<b>Total Score for Habitat Functions</b> Add the points for H 1 and H 2; then <b>record the result on p. 1</b>	10

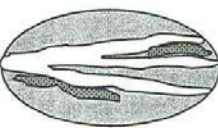
Comments:



SC4	<p><b>Forested Wetlands</b> (see p. 90)</p> <p>Does the wetland have at least 1 acre of forest that meet one of these criteria for the Department of Fish and Wildlife's forests as priority habitats? <i>If you answer yes you will still need to rate the wetland based on its function.</i></p> <p>___ <b>Old-growth forests:</b> (west of Cascade Crest) Stands of at least two three species forming a multi-layered canopy with occasional small openings; with at least 8 trees/acre (20 trees/hectare) that are at least 200 years of age OR have a diameter at breast height (dbh) of 32 inches (81 cm or more).</p> <p>NOTE: The criterion for dbh is based on measurements for upland forests. Two-hundred year old trees in wetlands will often have a smaller dbh because their growth rates are often slower. The DFW criterion is and "OR" so old-growth forests do not necessarily have to have trees of this diameter.</p> <p>___ <b>Mature forests:</b> (west of the Cascade Crest) Stands where the largest trees are 80 – 200 years old OR have an average diameters (dbh) exceeding 21 inches (53 cm); crown cover may be less than 100%; decay, decadence, numbers of snags, and quantity of large downed material is generally less than that found in old-growth.</p> <p>YES = Category I                      NO = <u>X</u> not a forested wetland with special characteristics</p>	Cat. I
SC5	<p><b>Wetlands in Coastal Lagoons</b> (see p. 91)</p> <p>Does the wetland meet all of the following criteria of a wetland in a coastal lagoon?</p> <p>___ The wetland lies in a depression adjacent to marine waters that is wholly or partially separated from marine waters by sandbanks, gravel banks, shingle, or, less frequently, rocks.</p> <p>___ The lagoon in which the wetland is located contains surface water that is saline or brackish (&gt; 0.5 ppt) during most of the year in at least a portion of the lagoon (<i>needs to be measured near the bottom.</i>)</p> <p>YES = Go to SC 5.1                      NO <u>X</u> not a wetland in a coastal lagoon</p> <p>SC 5.1 Does the wetland meet all of the following three conditions?</p> <p>___ The wetland is relatively undisturbed (has no diking, ditching, filling, cultivation, grazing) and has less than 20% cover of invasive plant species (see list of invasive species on p. 74).</p> <p>___ At least 3/4 of the landward edge of the wetland has a 100 ft. buffer of shrub, forest, or un-grazed or un-mowed grassland.</p> <p>___ The wetland is larger than 1/10 acre (4350 square ft.)</p> <p>YES = Category I                      NO = Category II</p>	Cat. I Cat. II
SC6	<p><b>Interdunal Wetlands</b> (see p. 93)</p> <p>Is the wetland west of the 1889 line (also called the Western Boundary of Upland Ownership or WBUO)?</p> <p>YES = Go to SC 6.1                      NO <u>X</u> not an interdunal wetland for rating</p> <p><i>If you answer yes you will still need to rate the wetland based on its functions.</i></p> <p>In practical terms that means the following geographic areas:</p> <ul style="list-style-type: none"> <li>• Long Beach Peninsula -- lands west of SR 103</li> <li>• Grayland-Westport -- lands west of SR 105</li> <li>• Ocean Shores-Copalis – lands west of SR 115 and SR 109</li> </ul> <p>SC 6.1 Is the wetland one acre or larger, or is it in a mosaic of wetlands that is one acre or larger?</p> <p>YES = Category II                      NO = go to SC 6.2</p> <p>SC 6.2 Is the wetland between 0.1 and 1 acre, or is it in a mosaic of wetlands that is between 0.1 and 1 acre?</p> <p>YES = Category III</p>	Cat. II Cat. III
◆	<p><b>Category of wetland based on Special Characteristics</b></p> <p>Choose the "highest" rating if wetland falls into several categories, and record on p. 1.</p> <p>If you answered NO for all types enter "Not Applicable" on p. 1</p>	NA

Comments:

Wetland name or number 22AB

**WETLAND RATING FORM – WESTERN WASHINGTON**  
Version 2 – Updated July 2006 to increase accuracy and reproducibility among users  
Updated Oct. 2008 with the new WDFW definitions for priority habitats

Name of wetland (if known): 22AB Date of site visit: 09-20-13

Rated by: Colin Worsley / Matt Maynard Trained by Ecology? Yes X No      Date of training: 11-2005 / 04-2006

SEC: 06 TOWNSHIP: 24N RANGE: 06E Is S/T/R in Appendix D? Yes      No X

Map of wetland unit: Figure      Estimated size 0.46 acre

**SUMMARY OF RATING**

Category based on FUNCTIONS provided by wetland: I      II      III X IV     

Category I =	Score > 70
Category II =	Score 51 - 69
Category III =	Score 30 – 50
Category IV =	Score < 30

Score for Water Quality Functions	20
Score for Hydrologic Functions	6
Score for Habitat Functions	20
<b>TOTAL Score for Functions</b>	<b>46</b>

Category based on SPECIAL CHARACTERISTICS of Wetland I      II      Does not apply X

**Final Category** (choose the “highest” category from above”) **III**

**Summary of basic information about the wetland unit.**

Wetland Unit has Special Characteristics		Wetland HGM Class used for Rating	
<b>Estuarine</b>		<b>Depressional</b>	<b>X</b>
<b>Natural Heritage Wetland</b>		<b>Riverine</b>	
<b>Bog</b>		<b>Lake-fringe</b>	
<b>Mature Forest</b>		<b>Slope</b>	(x)
<b>Old Growth Forest</b>		<b>Flats</b>	
<b>Coastal Lagoon</b>		<b>Freshwater Tidal</b>	
<b>Interdunal</b>			
None of the above	X	Check if unit has multiple HGM classes present	<b>X</b>

**Does the wetland being rated meet any of the criteria below?** If you answer YES to any of the questions below you will need to protect the wetland according to the regulations regarding the special characteristics found in the wetland.

Check List for Wetlands that Need Additional Protection (in addition to the protection recommended for its category)	YES	NO
SP1. <i>Has the wetland unit been documented as a habitat for any Federally listed Threatened or Endangered <b>animal or plant</b> species (T/E species)?</i> For the purposes of this rating system, “documented” means the wetland is on the appropriate state or federal database.		X
SP2. <i>Has the wetland unit been documented as habitat for any State listed Threatened or Endangered <b>animal</b> species?</i> For the purposes of this rating system, “documented” means the wetland is on the appropriate state database. Note: Wetlands with State listed plant species are categorized as Category 1 Natural Heritage Wetlands (see p. 19 of data form).		X
SP3. <i>Does the wetland unit contain individuals of Priority species listed by the WDFW for the state?</i>		X
SP4. <i>Does the wetland unit have a local significance in addition to its functions?</i> For example, the wetland has been identified in the Shoreline Master Program, the Critical Areas Ordinance, or in a local management plan as having special significance.		X

To complete the next part of the data sheet you will need to determine the Hydrogeomorphic Class of the wetland being rated.

Exhibit 16  
SSDP2016-00415  
001097

### Classification of Vegetated Wetlands for Western Washington

If the hydrologic criteria listed in each question do not apply to the entire unit being rated, you probably have a unit with multiple HGM classes. In this case, identify which hydrologic criteria in questions 1-7 apply, and go to Question 8.

1. Are the water levels in the entire unit usually controlled by tides (i.e. except during floods)?  
NO – go to 2                      **YES – the wetland class is Tidal Fringe**  
 If yes, is the salinity of the water during periods of annual low flow below 0.5 ppt (parts per thousand)?  
**YES – Freshwater Tidal Fringe**                      **NO – Saltwater Tidal Fringe (Estuarine)**  
*If your wetland can be classified as a Freshwater Tidal Fringe use the forms for Riverine wetlands. If it is a Saltwater Tidal Fringe it is rated as an Estuarine wetland. Wetlands that were call estuarine in the first and second editions of the rating system are called Salt Water Tidal Fringe in the Hydrogeomorphic Classification. Estuarine wetlands were categorized separately in the earlier editions, and this separation is being kept in this revision. To maintain consistency between editions, the term “Estuarine” wetland is kept. Please note, however, that the characteristics that define Category I and II estuarine wetlands have changed (see p. \_\_\_\_\_).*

---

2. The entire wetland unit is flat and precipitation is only source (>90%) of water to it. Groundwater and surface water runoff are NOT sources of water to the unit.  
NO – go to 3                      **YES – The wetland class is Flats**  
 If your wetland can be classified as a “Flats” wetland, use the form for **Depressional** wetlands.

---

3. Does the entire wetland meet both of the following criteria?  
 \_\_\_\_\_ The vegetated part of the wetland is on the shores of a body of permanent open water (without any vegetation on the surface) where at least 20 acres (8ha) in size;  
 \_\_\_\_\_ At least 30% of the open water area is deeper than 6.6 (2 m)?  
NO – go to 4                      **YES – The wetland class is Lake-fringe (Lacustrine Fringe)**

---

4. Does the entire wetland meet all of the following criteria?  
 \_\_\_\_\_ The wetland is on a slope (*slope can be very gradual*).  
 \_\_\_\_\_ The water flows through the wetland in one direction (unidirectional) and usually comes from seeps. It may flow subsurface, as sheetflow, or in a swale without distinct banks.  
 \_\_\_\_\_ The water leaves the wetland **without being impounded**?  
 NOTE: *Surface water does not pond in these types of wetlands except occasionally in very small and shallow depressions or behind hummocks (depressions are usually <3 ft diameter and less than 1 foot deep).*  
NO – go to 5                      **YES – The wetland class is Slope**

---

5. Does the entire wetland meet all of the following criteria?  
 \_\_\_\_\_ The unit is in a valley or stream channel where it gets inundated by overbank flooding from that stream or river.  
 \_\_\_\_\_ The overbank flooding occurs at least once every two years.  
 NOTE: *The riverine unit can contain depressions that are filled with water when the river is not flooding..*  
NO – go to 6                      **YES – The wetland class is Riverine**

---

6. Is the entire wetland unit in a topographic depression in which water ponds, or is saturated to the surface, at some time of the year. This means that any outlet, if present is higher than the interior of the wetland.  
NO – go to 7                      **YES – The wetland class is Depressional**

---

7. Is the entire wetland located in a very flat area with no obvious depression and no overbank flooding. The unit does not pond surface water more than a few inches. The unit seems to be maintained by high groundwater in the area. The wetland may be ditched, but has no obvious natural outlet.  
No – go to 8                      **YES – The wetland class is Depressional**

---

8. Your wetland unit seems to be difficult to classify and probably contains several different HGM classes. For example, seeps at the base of a slope may grade into a riverine floodplain, or a small stream within a depressional wetland has a zone of flooding along its sides. **GO BACK AND IDENTIFY WHICH OF THE HYDROLOGIC REGIMES DESCRIBED IN QUESTIONS 1-7 APPLY TO DIFFERENT AREAS IN THE UNIT** (make a rough sketch to help you decide). Use the following table to identify the appropriate class to use for the rating system if you have several HGM classes present within your wetland. NOTE: Use this table only if the class that is recommended in the second column represents 10% or more of the total area of the wetland unit being rated. If the area of the class listed in column 2 is less than 10% of the unit, classify the wetland using the class that represents more than 90% of the total area.

HGM Classes within the wetland unit being rated	HGM Class to Use in Rating
Slope + Riverine	Riverine
Slope + Depressional	Depressional
Slope + Lake-fringe	Lake-fringe
Depressional + Riverine along stream within boundary	Depressional
Depressional + Lake-fringe	Depressional
Salt Water Tidal Fringe and any other class of freshwater wetland	Treat as ESTUARINE under wetlands with special characteristics

**Exhibit 16**  
**SSDP2016-00415**  
**001058**

If you are unable still to determine which of the above criteria apply to your wetland, or you have more than 2 HGM classes within a wetland boundary, classify the wetland as **Depressional** for the rating.





<b>D 4</b>	<p><b>Does the wetland have the <u>opportunity</u> to reduce flooding and erosion?</b></p> <p>Answer YES if the unit is in a location in the watershed where the flood storage, or reduction in water velocity, it provides helps protect downstream property and aquatic resources from flooding or excessive and/or erosive flows. Answer NO if the water coming into the wetland is controlled by a structure such as flood gate, tide gate, flap valve, reservoir etc. OR you estimate that more than 90% of the water in the wetland is from groundwater in areas where damaging groundwater flooding does not occur. <i>Note which of the following indicators of opportunity apply.</i></p> <p><input type="checkbox"/> Wetland is in a headwater of a river or stream that has flooding problems.</p> <p><input type="checkbox"/> Wetland drains to a river or stream that has flooding problems</p> <p><input checked="" type="checkbox"/> Wetland has no outlet and impounds surface runoff water that might otherwise flow into a river or stream that has flooding problems</p> <p><input type="checkbox"/> Other _____</p> <p><b>YES multiplier is 2</b>                      NO multiplier is 1</p>	<p>(see p. 49)</p> <p>Multiplier</p> <p><u>X2</u></p>
◆	<p><b>TOTAL – Hydrologic Functions</b>                      Multiply the score from D3 by D4; then <i>add score to table on p. 1</i></p>	<p>6</p>

Comments:







<i>These questions apply to wetlands of all HGM classes.</i> HABITAT FUNCTIONS – Indicators that wetland functions to provide important habitat.		<b>Points</b> (only 1 score per box)									
<b>H 1</b>	<b>Does the wetland have the <u>potential</u> to provide habitat for many species?</b>	Figure ____									
	H 1.1 <u>Vegetation structure</u> (see P. 72): Check the types of vegetation classes present (as defined by Cowardin) – Size threshold for each class is 1/4 acre or more than 10% of the area if unit is smaller than 2.5 acres. <input type="checkbox"/> Aquatic Bed <input checked="" type="checkbox"/> Emergent plants <input checked="" type="checkbox"/> Scrub/shrub (areas where shrubs have > 30% cover) <input checked="" type="checkbox"/> Forested (areas where trees have > 30% cover) If the unit has a forested class check if: <input checked="" type="checkbox"/> The forested class has 3 out of 5 strata (canopy, sub-canopy, shrubs, herbaceous, moss/ground-cover) that each cover 20% within the forested polygon. Add the number of vegetation types that qualify. If you have: <table style="margin-left: 20px;"> <tr> <td>4 structures or more.....</td> <td>points = 4</td> <td rowspan="3" style="vertical-align: middle;"><b>Map of Cowardin vegetation classes</b></td> </tr> <tr> <td>3 structures.....</td> <td>points = 2</td> </tr> <tr> <td>1 structure.....</td> <td>points = 0</td> </tr> </table>	4 structures or more.....	points = 4	<b>Map of Cowardin vegetation classes</b>	3 structures.....	points = 2	1 structure.....	points = 0	4		
4 structures or more.....	points = 4	<b>Map of Cowardin vegetation classes</b>									
3 structures.....	points = 2										
1 structure.....	points = 0										
	H 1.2 <u>Hydroperiods</u> (see p.73): Check the types of water regimes (hydroperiods) present within the wetland. The water regime has to cover more than 10% of the wetland or 1/4 acre to count (see text for descriptions of hydroperiods). <input checked="" type="checkbox"/> Permanently flooded or inundated <input checked="" type="checkbox"/> Seasonally flooded or inundated <input checked="" type="checkbox"/> Occasionally flooded or inundated <input checked="" type="checkbox"/> Saturated only <input checked="" type="checkbox"/> Permanently flowing stream or river in, or adjacent to, the wetland <input type="checkbox"/> Seasonally flowing stream in, or adjacent to, the wetland <input type="checkbox"/> Lake-fringe wetland..... = 2 points <input type="checkbox"/> Freshwater tidal wetland..... = 2 points <table style="margin-left: 20px;"> <tr> <td>4 or more types present</td> <td>points = 3</td> <td rowspan="4" style="vertical-align: middle;"><b>Map of hydroperiods</b></td> </tr> <tr> <td>3 or more types present.....</td> <td>points = 2</td> </tr> <tr> <td>2 types present.....</td> <td>points = 1</td> </tr> <tr> <td>1 type present.....</td> <td>points = 0</td> </tr> </table>	4 or more types present	points = 3	<b>Map of hydroperiods</b>	3 or more types present.....	points = 2	2 types present.....	points = 1	1 type present.....	points = 0	3
4 or more types present	points = 3	<b>Map of hydroperiods</b>									
3 or more types present.....	points = 2										
2 types present.....	points = 1										
1 type present.....	points = 0										
	H 1.3 <u>Richness of Plant Species</u> (see p. 75): Count the number of plant species in the wetland that cover at least 10 ft <sup>2</sup> (different patches of the same species can be combined to meet the size threshold) You do not have to name the species. Do not include Eurasian Milfoil, reed canarygrass, purple loosestrife, Canadian Thistle. If you counted: <table style="margin-left: 20px;"> <tr> <td>&gt; 19 species.....</td> <td>points = 2</td> </tr> <tr> <td>5 – 19 species.....</td> <td>points = 1</td> </tr> <tr> <td>&lt; 5 species.....</td> <td>points = 0</td> </tr> </table> List species below if you want to: _____ _____ _____	> 19 species.....	points = 2	5 – 19 species.....	points = 1	< 5 species.....	points = 0	2			
> 19 species.....	points = 2										
5 – 19 species.....	points = 1										
< 5 species.....	points = 0										
	H 1.4 <u>Interspersion of Habitats</u> (see p. 76): Decided from the diagrams below whether interspersion between Cowardin vegetation (described in H1.1), or the classes and unvegetated areas (can include open water or mudflats) is high, medium, low, or none. <div style="display: flex; justify-content: space-around; align-items: flex-start;"> <div style="text-align: center;">                           None = 0 points                     </div> <div style="text-align: center;">                           Low = 1 point                     </div> <div style="text-align: center;">                           Moderate = 2 points                     </div> <div style="text-align: center;">                           High = 3 points                     </div> </div> <div style="margin-top: 20px;">    <div style="margin-left: 100px;">[riparian braided channels]</div> </div> <div style="margin-top: 20px;"> <p>Note: If you have 4 or more classes or 3 vegetation classes and open water, the rating is always “high”.</p> <p>Use map of Cowardin classes.</p> </div>	2									
	H 1.5 <u>Special Habitat Features</u> (see p. 77): Check the habitat features that are present in the wetland. The number of checks is the number of points you put into the next column. <input checked="" type="checkbox"/> Large, downed, woody debris within the wetland (> 4 in. diameter and 6 ft. long) <input type="checkbox"/> Standing snags (diameter at the bottom > 4 inches) in the wetland <input type="checkbox"/> Undercut banks are present for at least 6.6 ft. (2m) and/or overhanging vegetation extends at least 3.3 ft. (1m) over a stream (or ditch) in, or contiguous with the unit, for at least 33 ft. (10m) <input type="checkbox"/> Stable steep banks of fine material that might be used by beaver or muskrat for denning (> 30 degree slope) OR signs of recent beaver activity are present (cut shrubs or trees that have not yet turned grey/brown) <input type="checkbox"/> At least 1/4 acre of thin-stemmed persistent vegetation or woody branches are present in areas that are permanently or seasonally inundated (structures for egg-laying by amphibians) <input type="checkbox"/> Invasive plants cover less than 25% of the wetland area in each stratum of plants NOTE: The 20% stated in early printings of the manual on page 78 is an error.	1									
<b>H 1 TOTAL Score – potential for providing habitat</b>		Add the points in the column. <span style="color: red;">001061</span>									

Exhibit 16  
SSDP2016-00415  
001061

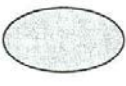

	<p>H 2.3 <u>Near or adjacent to other priority habitats listed by WDFW</u> (see p. 82): (see new and complete descriptions of WDFW priority habitats, and the counties in which they can be found, in the PHS report <a href="http://wdfw.wa.gov/hab/phslist.htm">http://wdfw.wa.gov/hab/phslist.htm</a>)</p> <p>Which of the following priority habitats are within 330 ft. (100m) of the wetland unit?  <i>NOTE: the connections do not have to be relatively undisturbed.</i></p> <p><input type="checkbox"/> <b>Aspen Stands:</b> Pure or mixed stands of aspen greater than 0.4 ha (1 acre).</p> <p><input type="checkbox"/> <b>Biodiversity Areas and Corridors:</b> Areas of habitat that are relatively important to various species of native fish and wildlife (full descriptions in WDFW PHS report p. 152).</p> <p><input type="checkbox"/> <b>Herbaceous Balds:</b> Variable size patches of grass and forbs on shallow soils over bedrock.</p> <p><input type="checkbox"/> <b>Old-growth/Mature forests:</b> (Old-growth west of Cascade crest) Stands of at least 2 tree species, forming a multi-layered canopy with occasional small openings; with at least 20 trees/ha (8 trees/acre) &gt; 81 cm (32 in) dbh or &gt; 200 years of age. (Mature forests) Stands with average diameters exceeding 53 cm (21 in) dbh; crown cover may be less than 100%; decay, decadence, numbers of snags, and quantity of large downed material is generally less than that found in old-growth; 80 - 200 years old west of the Cascade crest.</p> <p><input type="checkbox"/> <b>Oregon white Oak:</b> Woodlands Stands of pure oak or oak/conifer associations where canopy coverage of the oak component is important (full descriptions in WDFW PHS report p. 158).</p> <p><input checked="" type="checkbox"/> <b>Riparian:</b> The area adjacent to aquatic systems with flowing water that contains elements of both aquatic and terrestrial ecosystems which mutually influence each other.</p> <p><input type="checkbox"/> <b>Westside Prairies:</b> Herbaceous, non-forested plant communities that can either take the form of a dry prairie or a wet prairie (full descriptions in WDFW PHS report p. 161).</p> <p><input checked="" type="checkbox"/> <b>Instream:</b> The combination of physical, biological, and chemical processes and conditions that interact to provide functional life history requirements for instream fish and wildlife resources.</p> <p><input type="checkbox"/> <b>Nearshore:</b> Relatively undisturbed nearshore habitats. These include Coastal Nearshore, Open Coast Nearshore, and Puget Sound Nearshore. (full descriptions of habitats and the definition of relatively undisturbed are in WDFW report: pp. 167-169 and glossary in Appendix A).</p> <p><input type="checkbox"/> <b>Caves:</b> A naturally occurring cavity, recess, void, or system of interconnected passages under the earth in soils, rock, ice, or other geological formations and is large enough to contain a human.</p> <p><input type="checkbox"/> <b>Cliffs:</b> Greater than 7.6 m (25 ft) high and occurring below 5000 ft.</p> <p><input type="checkbox"/> <b>Talus:</b> Homogenous areas of rock rubble ranging in average size 0.15 - 2.0 m (0.5 - 6.5 ft), composed of basalt, andesite, and/or sedimentary rock, including riprap slides and mine tailings. May be associated with cliffs.</p> <p><input type="checkbox"/> <b>Snags and Logs:</b> Trees are considered snags if they are dead or dying and exhibit sufficient decay characteristics to enable cavity excavation/use by wildlife. Priority snags have a diameter at breast height of &gt; 51 cm (20 in) in western Washington and are &gt; 2 m (6.5 ft) in height. Priority logs are &gt; 30 cm (12 in) in diameter at the largest end, and &gt; 6 m (20 ft) long.</p> <p>If wetland has <b>3 or more</b> priority habitats = <b>4 points</b>  <b>If wetland has 2</b> priority habitats = <b>3 points</b>                  If wetland has <b>1</b> priority habitat = <b>1 point</b>                      No habitats = 0 points</p> <p>Note: All vegetated wetlands are by definition a priority habitat but are not included in this list. Nearby wetlands are addressed in question H 2.4)</p>	3
	<p>H 2.4 <u>Wetland Landscape:</u> Choose the <b>one</b> description of the landscape around the wetland that best fits (see p. 84)</p> <ul style="list-style-type: none"> <li>• There are at least 3 other wetlands within 1/2 mile, and the connections between them are relatively undisturbed (light grazing between wetlands OK, as is lake shore with some boating, but connections should NOT be bisected by paved roads, fill, fields, or other development.....points = 5</li> <li>• The wetland is Lake-fringe on a lake with little disturbance and there are 3 other lake-fringe wetlands within 1/2 mile .....points = 5</li> <li>• <b>There are at least 3 other wetlands within 1/2 mile, BUT the connections between them are disturbed.....points = 3</b></li> <li>• The wetland fringe on a lake <b>with</b> disturbance and there are 3 other lake-fringe wetlands within 1/2 mile .....points = 3</li> <li>• There is at least 1 wetland within 1/2 mile .....points = 2</li> <li>• There are no wetlands within 1/2 mile.....points = 0</li> </ul>	3
<p><b>H 2 TOTAL Score</b> – opportunity for providing habitat      <i>Add the scores from H2.1, H2.2, H2.3, H2.4</i></p>		8
<p><i>TOTAL for H 1 from page 8</i></p>		12
◆	<p><b>Total Score for Habitat Functions</b>                      Add the points for H 1 and H 2; then <b>record the result on p. 1</b></p>	20

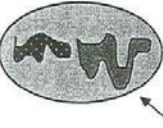
Comments:

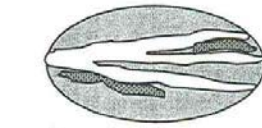
### CATEGORIZATION BASED ON SPECIAL CHARACTERISTICS

*Please determine if the wetland meets the attributes described below  
and circle the appropriate answers and Category.*

<b>Wetland Type</b> – Check off any criteria that apply to the wetland. Circle the Category when the appropriate criteria are met.	
<b>SC1</b>	<p><b>Estuarine wetlands?</b> (see p.86)</p> <p>Does the wetland unit meet the following criteria for Estuarine wetlands?</p> <p><input type="checkbox"/> The dominant water regime is tidal,</p> <p><input type="checkbox"/> Vegetated, and</p> <p><input type="checkbox"/> With a salinity greater than 0.5 ppt.</p> <p style="text-align: center;">YES = Go to SC 1.1                      NO <u>  X  </u></p>
	<p>SC 1.1 Is the wetland unit within a National Wildlife Refuge, National Park, National Estuary Reserve, Natural Area Preserve, State Park or Educational, Environmental, or Scientific Reserve designated under WAC 332-30-151?      YES = Category I                      NO = go to SC 1.2</p>
	<p>SC 1.2 Is the wetland at least 1 acre in size and meets at least two of the following conditions?</p> <p style="text-align: center;">YES = Category I                      NO = Category II</p> <p><input type="checkbox"/> The wetland is relatively undisturbed (has no diking, ditching, filling, cultivation, grazing, and has less than 10% cover of non-native plant species. If the non-native <i>Spartina</i> spp., are only species that cover more than 10% of the wetland, then the wetland should be given a dual rating (I/II). The area of <i>Spartina</i> would be rated a Category II while the relatively undisturbed upper marsh with native species would be a Category I. Do not, however, exclude the area of <i>Spartina</i> in determining the size threshold of 1 acre.</p> <p><input type="checkbox"/> At least 3/4 of the landward edge of the wetland has a 100 ft. buffer of shrub, forest, or un-grazed or un-mowed grassland</p> <p><input type="checkbox"/> The wetland has at least 2 of the following features: tidal channels, depressions with open water, or contiguous freshwater wetlands.</p>
	<p><b>Cat. I</b></p> <p><b>Cat. I</b></p> <p><b>Cat. II</b></p> <p><b>Dual Rating I/II</b></p>
<b>SC2</b>	<p><b>Natural Heritage Wetlands</b> (see p. 87)</p> <p>Natural Heritage wetlands have been identified by the Washington Natural Heritage Program/DNR as either high quality undisturbed wetlands or wetlands that support state Threatened, Endangered, or Sensitive plant species.</p> <p>SC 2.1 Is the wetland being rated in a Section/Township/Range that contains a natural heritage wetland? (<i>This question is used to screen out most sites before you need to contact WNHP/DNR.</i>)</p> <p style="text-align: center;">S/T/R information from Appendix D _____ or accessed from WNHP/DNR web site _____</p> <p style="text-align: center;">YES _____ Contact WNHP/DNR (see p. 79) and go to SC 2.2                      NO <u>  X  </u></p> <p>SC 2.2 Has DNR identified the wetland as a high quality undisturbed wetland or as a site with state threatened or endangered plant species?</p> <p style="text-align: center;">YES = Category 1                      NO _____ not a Heritage Wetland</p>
	<p><b>Cat I</b></p>
<b>SC3</b>	<p><b>Bogs</b> (see p. 87)</p> <p>Does the wetland (<b>or any part of the unit</b>) meet both the criteria for soils and vegetation in bogs? Use the key below to identify if the wetland is a bog. <i>If you answer yes you will still need to rate the wetland based on its function.</i></p> <ol style="list-style-type: none"> <li>1. Does the unit have organic soil horizons (i.e. layers of organic soil), either peats or mucks, that compose 16 inches or more of the first 32 inches of soil profile? (See Appendix B for a field key to identify organic soils)?      YES = go to question 3      <b>NO = go to question 2</b></li> <li>2. Does the wetland have organic soils, either peats or mucks that are less than 16 inches deep over bedrock, or an impermeable hardpan such as clay or volcanic ash, or that are floating on a lake or pond?      YES = go to question 3      <b>NO = is not a bog for purpose of rating</b></li> <li>3. Does the unit have more than 70% cover of mosses at ground level, AND other plants, if present, consist of the “bog” species listed in Table 3 as a significant component of the vegetation (more than 30% of the total shrub and herbaceous cover consists of species in Table 3)?</li> </ol> <p style="text-align: center;">YES = Is a bog for purpose of rating                      NO = go to question 4</p> <p>NOTE: If you are uncertain about the extent of mosses in the understory you may substitute that criterion by measuring the pH of the water that seeps into a hole dug at least 16” deep. If the pH is less than 5.0 and the “bog” plant species in Table 3 are present, the wetland is a bog.</p> <ol style="list-style-type: none"> <li>4. Is the unit forested (&gt; 30% cover) with sitka spruce, subalpine fir, western red cedar, western hemlock, lodgepole pine, quaking aspen, Englemann’s spruce, or western white pine. WITH any of the species (or combination of species) on the bog species plant list in Table 3 as a significant component of the ground cover (&gt; 30% coverage of the total shrub/herbaceous cover)?</li> </ol> <p style="text-align: center;">YES = Category I                      NO = Is not a bog for purpose of rating</p>
	<p><b>Cat. I</b></p>

**Exhibit 16**  
**SSDP2016-00415**  
**001064**

SC4	<p><b>Forested Wetlands</b> (see p. 90)</p> <p>Does the wetland have at least 1 acre of forest that meet one of these criteria for the Department of Fish and Wildlife's forests as priority habitats? <i>If you answer yes you will still need to rate the wetland based on its function.</i></p> <p>___ <b>Old-growth forests:</b> (west of Cascade Crest) Stands of at least two three species forming a multi-layered canopy with occasional small openings; with at least 8 trees/acre (20 trees/hectare) that are at least 200 years of age OR have a diameter at breast height (dbh) of 32 inches (81 cm or more).</p> <p>NOTE: The criterion for dbh is based on measurements for upland forests. Two-hundred year old trees in wetlands will often have a smaller dbh because their growth rates are often slower. The DFW criterion is and "OR" so old-growth forests do not necessarily have to have trees of this diameter.</p> <p>___ <b>Mature forests:</b> (west of the Cascade Crest) Stands where the largest trees are 80 – 200 years old OR have an average diameters (dbh) exceeding 21 inches (53 cm); crown cover may be less than 100%; decay, decadence, numbers of snags, and quantity of large downed material is generally less than that found in old-growth.</p> <p>YES = Category I                      NO = <u>X</u> not a forested wetland with special characteristics</p>	Cat. I
SC5	<p><b>Wetlands in Coastal Lagoons</b> (see p. 91)</p> <p>Does the wetland meet all of the following criteria of a wetland in a coastal lagoon?</p> <p>___ The wetland lies in a depression adjacent to marine waters that is wholly or partially separated from marine waters by sandbanks, gravel banks, shingle, or, less frequently, rocks.</p> <p>___ The lagoon in which the wetland is located contains surface water that is saline or brackish (&gt; 0.5 ppt) during most of the year in at least a portion of the lagoon (<i>needs to be measured near the bottom.</i>)</p> <p>YES = Go to SC 5.1                      NO <u>X</u> not a wetland in a coastal lagoon</p> <p>SC 5.1 Does the wetland meet all of the following three conditions?</p> <p>___ The wetland is relatively undisturbed (has no diking, ditching, filling, cultivation, grazing) and has less than 20% cover of invasive plant species (see list of invasive species on p. 74).</p> <p>___ At least 3/4 of the landward edge of the wetland has a 100 ft. buffer of shrub, forest, or un-grazed or un-mowed grassland.</p> <p>___ The wetland is larger than 1/10 acre (4350 square ft.)</p> <p>YES = Category I                      NO = Category II</p>	Cat. I Cat. II
SC6	<p><b>Interdunal Wetlands</b> (see p. 93)</p> <p>Is the wetland west of the 1889 line (also called the Western Boundary of Upland Ownership or WBUO)?</p> <p>YES = Go to SC 6.1                      NO <u>X</u> not an interdunal wetland for rating</p> <p><i>If you answer yes you will still need to rate the wetland based on its functions.</i></p> <p>In practical terms that means the following geographic areas:</p> <ul style="list-style-type: none"> <li>• Long Beach Peninsula -- lands west of SR 103</li> <li>• Grayland-Westport -- lands west of SR 105</li> <li>• Ocean Shores-Copalis – lands west of SR 115 and SR 109</li> </ul> <p>SC 6.1 Is the wetland one acre or larger, or is it in a mosaic of wetlands that is one acre or larger?</p> <p>YES = Category II                      NO = go to SC 6.2</p> <p>SC 6.2 Is the wetland between 0.1 and 1 acre, or is it in a mosaic of wetlands that is between 0.1 and 1 acre?</p> <p>YES = Category III</p>	Cat. II Cat. III
◆	<p><b>Category of wetland based on Special Characteristics</b></p> <p>Choose the "highest" rating if wetland falls into several categories, and record on p. 1.</p> <p>If you answered NO for all types enter "Not Applicable" on p. 1</p>	NA

Comments:

**Exhibit 16**  
**SSDP2016-00415**  
**001065**

Wetland name or number 22CD

**WETLAND RATING FORM – WESTERN WASHINGTON**  
Version 2 – Updated July 2006 to increase accuracy and reproducibility among users  
Updated Oct. 2008 with the new WDFW definitions for priority habitats

Name of wetland (if known): 22CD Date of site visit: 10-25-13

Rated by: Colin Worsley / Matt Maynard Trained by Ecology? Yes X No      Date of training: 11-2005 / 04-2006

SEC: 06 TOWNSHIP: 24N RANGE: 06E Is S/T/R in Appendix D? Yes      No X

Map of wetland unit: Figure      Estimated size 0.46 acre

**SUMMARY OF RATING**

Category based on FUNCTIONS provided by wetland: I      II      III      IV X

Category I =	Score > 70
Category II =	Score 51 - 69
Category III =	Score 30 – 50
Category IV =	Score < 30

Score for Water Quality Functions	6
Score for Hydrologic Functions	7
Score for Habitat Functions	9
<b>TOTAL Score for Functions</b>	<b>22</b>

Category based on SPECIAL CHARACTERISTICS of Wetland I      II      Does not apply X

**Final Category** (choose the “highest” category from above”) IV

**Summary of basic information about the wetland unit.**

Wetland Unit has Special Characteristics		Wetland HGM Class used for Rating	
<b>Estuarine</b>		<b>Depressional</b>	X
<b>Natural Heritage Wetland</b>		<b>Riverine</b>	
<b>Bog</b>		<b>Lake-fringe</b>	
<b>Mature Forest</b>		<b>Slope</b>	(x)
<b>Old Growth Forest</b>		<b>Flats</b>	
<b>Coastal Lagoon</b>		<b>Freshwater Tidal</b>	
<b>Interdunal</b>			
None of the above	X	Check if unit has multiple HGM classes present	X

**Does the wetland being rated meet any of the criteria below?** If you answer YES to any of the questions below you will need to protect the wetland according to the regulations regarding the special characteristics found in the wetland.

Check List for Wetlands that Need Additional Protection (in addition to the protection recommended for its category)	YES	NO
SP1. <i>Has the wetland unit been documented as a habitat for any Federally listed Threatened or Endangered <b>animal or plant</b> species (T/E species)?</i> For the purposes of this rating system, “documented” means the wetland is on the appropriate state or federal database.		X
SP2. <i>Has the wetland unit been documented as habitat for any State listed Threatened or Endangered <b>animal</b> species?</i> For the purposes of this rating system, “documented” means the wetland is on the appropriate state database. Note: Wetlands with State listed plant species are categorized as Category 1 Natural Heritage Wetlands (see p. 19 of data form).		X
SP3. <i>Does the wetland unit contain individuals of Priority species listed by the WDFW for the state?</i>		X
SP4. <i>Does the wetland unit have a local significance in addition to its functions?</i> For example, the wetland has been identified in the Shoreline Master Program, the Critical Areas Ordinance, or in a local management plan as having special significance.		X

To complete the next part of the data sheet you will need to determine the Hydrogeomorphic Class of the wetland being rated.

The hydrogeomorphic classification groups wetlands in to those that function in similar ways. This simplifies the questions needed to answer how well the wetland functions. The Hydrogeomorphic Class of a wetland can be determined using the key below. See p. 24 for more detailed instructions on classifying wetlands.  
Wetland Rating Form – Western Washington, Version 2 (7/06), updated with new WDFW definitions Oct. 2008

Exhibit 16  
SSDP2016-00415  
001006

### Classification of Vegetated Wetlands for Western Washington

If the hydrologic criteria listed in each question do not apply to the entire unit being rated, you probably have a unit with multiple HGM classes. In this case, identify which hydrologic criteria in questions 1-7 apply, and go to Question 8.

1. Are the water levels in the entire unit usually controlled by tides (i.e. except during floods)?  
NO – go to 2                      **YES – the wetland class is Tidal Fringe**  
 If yes, is the salinity of the water during periods of annual low flow below 0.5 ppt (parts per thousand)?  
**YES – Freshwater Tidal Fringe**                      **NO – Saltwater Tidal Fringe (Estuarine)**  
*If your wetland can be classified as a Freshwater Tidal Fringe use the forms for Riverine wetlands. If it is a Saltwater Tidal Fringe it is rated as an Estuarine wetland. Wetlands that were call estuarine in the first and second editions of the rating system are called Salt Water Tidal Fringe in the Hydrogeomorphic Classification. Estuarine wetlands were categorized separately in the earlier editions, and this separation is being kept in this revision. To maintain consistency between editions, the term “Estuarine” wetland is kept. Please note, however, that the characteristics that define Category I and II estuarine wetlands have changed (see p. \_\_\_\_\_).*

---

2. The entire wetland unit is flat and precipitation is only source (>90%) of water to it. Groundwater and surface water runoff are NOT sources of water to the unit.  
NO – go to 3                      **YES – The wetland class is Flats**  
 If your wetland can be classified as a “Flats” wetland, use the form for **Depressional** wetlands.

---

3. Does the entire wetland meet both of the following criteria?  
 \_\_\_\_\_ The vegetated part of the wetland is on the shores of a body of permanent open water (without any vegetation on the surface) where at least 20 acres (8ha) in size;  
 \_\_\_\_\_ At least 30% of the open water area is deeper than 6.6 (2 m)?  
NO – go to 4                      **YES – The wetland class is Lake-fringe (Lacustrine Fringe)**

---

4. Does the entire wetland meet all of the following criteria?  
 \_\_\_\_\_ The wetland is on a slope (*slope can be very gradual*).  
 \_\_\_\_\_ The water flows through the wetland in one direction (unidirectional) and usually comes from seeps. It may flow subsurface, as sheetflow, or in a swale without distinct banks.  
 \_\_\_\_\_ The water leaves the wetland **without being impounded**?  
 NOTE: *Surface water does not pond in these types of wetlands except occasionally in very small and shallow depressions or behind hummocks (depressions are usually <3 ft diameter and less than 1 foot deep).*  
NO – go to 5                      **YES – The wetland class is Slope**

---

5. Does the entire wetland meet all of the following criteria?  
 \_\_\_\_\_ The unit is in a valley or stream channel where it gets inundated by overbank flooding from that stream or river.  
 \_\_\_\_\_ The overbank flooding occurs at least once every two years.  
 NOTE: *The riverine unit can contain depressions that are filled with water when the river is not flooding..*  
NO – go to 6                      **YES – The wetland class is Riverine**

---

6. Is the entire wetland unit in a topographic depression in which water ponds, or is saturated to the surface, at some time of the year. This means that any outlet, if present is higher than the interior of the wetland.  
NO – go to 7                      **YES – The wetland class is Depressional**

---

7. Is the entire wetland located in a very flat area with no obvious depression and no overbank flooding. The unit does not pond surface water more than a few inches. The unit seems to be maintained by high groundwater in the area. The wetland may be ditched, but has no obvious natural outlet.  
No – go to 8                      **YES – The wetland class is Depressional**

---

8. Your wetland unit seems to be difficult to classify and probably contains several different HGM classes. For example, seeps at the base of a slope may grade into a riverine floodplain, or a small stream within a depressional wetland has a zone of flooding along its sides. **GO BACK AND IDENTIFY WHICH OF THE HYDROLOGIC REGIMES DESCRIBED IN QUESTIONS 1-7 APPLY TO DIFFERENT AREAS IN THE UNIT** (make a rough sketch to help you decide). Use the following table to identify the appropriate class to use for the rating system if you have several HGM classes present within your wetland. NOTE: Use this table only if the class that is recommended in the second column represents 10% or more of the total area of the wetland unit being rated. If the area of the class listed in column 2 is less than 10% of the unit, classify the wetland using the class that represents more than 90% of the total area.

HGM Classes within the wetland unit being rated	HGM Class to Use in Rating
Slope + Riverine	Riverine
Slope + Depressional	Depressional
Slope + Lake-fringe	Lake-fringe
Depressional + Riverine along stream within boundary	Depressional
Depressional + Lake-fringe	Depressional
Salt Water Tidal Fringe and any other class of freshwater wetland	Treat as ESTUARINE under wetlands with special characteristics

**Exhibit 16**  
**SSDP2016-00415**  
**001067**

If you are unable still to determine which of the above criteria apply to your wetland, or you have more than 2 HGM classes within a wetland boundary, classify the wetland as **Depressional** for the rating.



<b>D Depressional and Flat Wetlands</b>		<b>Points</b>
WATER QUALITY FUNCTIONS – Indicators that wetland functions to improve water quality.		(only 1 score per box) (see p.38)
<b>D 1</b>	<b>Does the wetland have the <u>potential</u> to improve water quality?</b>	
D 1.1	Characteristics of surface water flows out of the wetland: <ul style="list-style-type: none"> <li>• Unit is a depression with no surface water leaving it (no outlet)..... points = 3</li> <li>• Unit has an <b>intermittently flowing, OR highly constricted, permanently flowing outlet</b> ..... points = <b>2</b></li> <li>• Unit has an unconstricted, or slightly constricted, surface outlet (<i>permanently flowing</i>) ..... points = 1</li> <li>• Unit is a “flat” depression (Q.7 on key), or in the Flats class, with permanent surface outflow <b>and no obvious natural outlet</b> and/or outlet is a man-made ditch..... points = 1 <i>(If ditch is not permanently flowing treat unit as “intermittently flowing”)</i> <b>Provide photo or drawing</b></li> </ul>	Figure ____ 2
D 1.2	The soil 2 inches below the surface (or duff layer) is clay or organic ( <i>use NRCS definitions</i> ) YES points = 4 <b>NO points = 0</b>	0
D 1.3	Characteristics of persistent vegetation (emergent, shrub, and/or forest Cowardin class): <ul style="list-style-type: none"> <li>• Wetland has persistent, ungrazed vegetation &gt; = 95% of area..... points = 5</li> <li>• Wetland has persistent, ungrazed vegetation &gt; = 1/2 of area..... points = 3</li> <li>• Wetland has <b>persistent, ungrazed vegetation &gt; = 1/10 of area</b>..... points = <b>1</b></li> <li>• Wetland has persistent, ungrazed vegetation &lt; 1/10 of area..... points = 0</li> </ul> <b>Map of Cowardin vegetation classes</b>	Figure ____ 1
D 1.4	Characteristics of seasonal ponding or inundation: <i>This is the area of the wetland that is ponded for at least 2 months, but dries out sometime during the year. Do not count the area that is permanently ponded. Estimate area as the average condition 5 out of 10 years.</i> <ul style="list-style-type: none"> <li>• Area seasonally ponded is &gt; 1/2 total area of wetland ..... points = 4</li> <li>• Area seasonally ponded is &gt; 1/4 total area of wetland ..... points = 2</li> <li>• <b>Area seasonally ponded is &lt; 1/4 total area of wetland</b> ..... points = <b>0</b></li> </ul> <b>Map of Hydroperiods</b>	Figure ____ 0
<b>Total for D 1</b>		Add the points in the boxes above <b>3</b>
<b>D 2</b>	<b>Does the wetland have the <u>opportunity</u> to improve water quality?</b> Answer YES if you know or believe there are pollutants in groundwater or surface water coming into the wetland that would otherwise reduce water quality in streams, lakes or groundwater downgradient from the wetland? <i>Note which of the following conditions provide the sources of pollutants. A unit may have pollutants coming from several sources, but any single source would qualify as opportunity.</i> ___ Grazing in the wetland or within 150 ft ___ Untreated stormwater discharges to wetland ___ Tilled fields or orchards within 150 ft. of wetland ___ A stream or culvert discharges into wetland that drains developed areas, residential areas, farmed fields, roads, or clear-cut logging <u> X </u> Residential, urban areas, golf courses are within 150 ft. of wetland ___ Wetland is fed by groundwater high in phosphorus or nitrogen ___ Other _____ <b>YES multiplier is 2</b> NO multiplier is 1	(see p. 44)  Multiplier  X2
<b>◆</b>	<b>TOTAL – Water Quality Functions</b> Multiply the score from D1 by D2; then <i>add score to table on p. 1</i>	<b>6</b>
HYDROLOGIC FUNCTIONS – Indicators that wetland unit functions to reduce flooding and stream degradation.		(see p.46)
<b>D 3</b>	<b>Does the wetland have the <u>potential</u> to reduce flooding and erosion?</b>	
D 3.1	Characteristics of surface water flows out of the wetland unit <ul style="list-style-type: none"> <li>• Unit is a depression with no surface water leaving it (no outlet)..... points = 4</li> <li>• Unit has an <b>intermittently flowing, OR highly constricted permanently flowing outlet</b> ..... points = <b>2</b></li> <li>• Unit is a “flat” depression (Q.7 on key) or in the Flats class, with permanent surface outflow <b>and no obvious natural outlet</b> and/or outlet is a man-made ditch..... points = 1 <i>(If ditch is not permanently flowing treat unit as “intermittently flowing”)</i></li> <li>• Unit has an unconstricted, or slightly constricted, surface outlet (<i>permanently flowing</i>) ..... points = 0</li> </ul>	2
D 3.2	Depth of storage during wet periods. <i>Estimate the height of ponding above the bottom of the outlet. For units with no outlet measure from the surface of permanent water or deepest part (if dry).</i> <ul style="list-style-type: none"> <li>• Marks of ponding are 3 ft. or more above the surface or bottom of the outlet ..... points = 7</li> <li>• The wetland is a “headwater” wetland..... points = 5</li> <li>• Marks of ponding between 2 ft. to &lt; 3 ft. from surface or bottom of outlet ..... points = 5</li> <li>• Marks are at least 0.5 ft. to &lt; 2 ft. from surface or bottom of outlet ..... points = 3</li> <li>• Wetland is flat (yes to Q.2 or Q.7 on key) but has small depressions on the surface that trap water points = 1</li> <li>• <b>Marks of ponding less than 0.5 ft</b> ..... points = <b>0</b></li> </ul>	0
D 3.3	Contribution of wetland unit to storage in the watershed: <i>Estimate the ratio of the area of upstream basin contributing surface water to the wetland to the area of the wetland unit itself.</i> <ul style="list-style-type: none"> <li>• <b>The area of the basin is less than 10 times the area of unit</b>..... points = <b>5</b></li> <li>• The area of the basin is 10 to 100 times the area of the unit ..... points = 3</li> <li>• The area of the basin is more than 100 times the area of the unit..... points = 0</li> <li>• Entire unit is in the FLATS class ..... points = 5</li> </ul>	5
<b>Total for D 3</b>		Add the points in the boxes above <b>7</b>

<b>D 4</b>	<p><b>Does the wetland have the <u>opportunity</u> to reduce flooding and erosion?</b></p> <p>Answer YES if the unit is in a location in the watershed where the flood storage, or reduction in water velocity, it provides helps protect downstream property and aquatic resources from flooding or excessive and/or erosive flows. Answer NO if the water coming into the wetland is controlled by a structure such as flood gate, tide gate, flap valve, reservoir etc. OR you estimate that more than 90% of the water in the wetland is from groundwater in areas where damaging groundwater flooding does not occur. <i>Note which of the following indicators of opportunity apply.</i></p> <p><input type="checkbox"/> Wetland is in a headwater of a river or stream that has flooding problems.</p> <p><input type="checkbox"/> Wetland drains to a river or stream that has flooding problems</p> <p><input type="checkbox"/> Wetland has no outlet and impounds surface runoff water that might otherwise flow into a river or stream that has flooding problems</p> <p><input type="checkbox"/> Other _____</p> <p>YES multiplier is 2      NO multiplier is 1</p>	<p>(see p. 49)</p> <p>Multiplier</p> <p>X1</p>
◆	<p><b>TOTAL – Hydrologic Functions</b>      Multiply the score from D3 by D4; then <i>add score to table on p. 1</i></p>	<p>7</p>

Comments:

<i>These questions apply to wetlands of all HGM classes.</i> HABITAT FUNCTIONS – Indicators that wetland functions to provide important habitat.		Points (only 1 score per box)									
<b>H 1</b>	<b>Does the wetland have the potential to provide habitat for many species?</b>	<b>Figure ____</b>									
	H 1.1 <u>Vegetation structure</u> (see P. 72): Check the types of vegetation classes present (as defined by Cowardin) – Size threshold for each class is 1/4 acre or more than 10% of the area if unit is smaller than 2.5 acres. <input type="checkbox"/> Aquatic Bed <input checked="" type="checkbox"/> Emergent plants <input checked="" type="checkbox"/> Scrub/shrub (areas where shrubs have > 30% cover) <input type="checkbox"/> Forested (areas where trees have > 30% cover) If the unit has a forested class check if: <input type="checkbox"/> The forested class has 3 out of 5 strata (canopy, sub-canopy, shrubs, herbaceous, moss/ground-cover) that each cover 20% within the forested polygon. Add the number of vegetation types that qualify. If you have: <table style="display: inline-table; vertical-align: middle; margin-left: 20px;"> <tr> <td>4 structures or more.....</td> <td>points = 4</td> <td rowspan="3" style="vertical-align: middle;"><b>Map of Cowardin vegetation classes</b></td> </tr> <tr> <td>3 structures.....</td> <td>points = 2</td> </tr> <tr> <td>1 structure.....</td> <td>points = 0</td> </tr> </table> <input checked="" type="checkbox"/> 2 structures..... points = 1	4 structures or more.....	points = 4	<b>Map of Cowardin vegetation classes</b>	3 structures.....	points = 2	1 structure.....	points = 0	1		
4 structures or more.....	points = 4	<b>Map of Cowardin vegetation classes</b>									
3 structures.....	points = 2										
1 structure.....	points = 0										
	H 1.2 <u>Hydroperiods</u> (see p.73): Check the types of water regimes (hydroperiods) present within the wetland. The water regime has to cover more than 10% of the wetland or 1/4 acre to count (see text for descriptions of hydroperiods). <input type="checkbox"/> Permanently flooded or inundated <input type="checkbox"/> Seasonally flooded or inundated <input checked="" type="checkbox"/> Occasionally flooded or inundated <input checked="" type="checkbox"/> Saturated only <input type="checkbox"/> Permanently flowing stream or river in, or adjacent to, the wetland <input type="checkbox"/> Seasonally flowing stream in, or adjacent to, the wetland <input type="checkbox"/> <b>Lake-fringe wetland..... = 2 points</b> <input type="checkbox"/> <b>Freshwater tidal wetland..... = 2 points</b>	<table style="display: inline-table; vertical-align: middle; margin-left: 20px;"> <tr> <td>4 or more types present</td> <td>points = 3</td> </tr> <tr> <td>3 or more types present.....</td> <td>points = 2</td> </tr> <tr> <td><b>2 types present.....</b></td> <td><b>points = 1</b></td> </tr> <tr> <td>1 type present.....</td> <td>points = 0</td> </tr> </table> <b>Map of hydroperiods</b>	4 or more types present	points = 3	3 or more types present.....	points = 2	<b>2 types present.....</b>	<b>points = 1</b>	1 type present.....	points = 0	1
4 or more types present	points = 3										
3 or more types present.....	points = 2										
<b>2 types present.....</b>	<b>points = 1</b>										
1 type present.....	points = 0										
	H 1.3 <u>Richness of Plant Species</u> (see p. 75): Count the number of plant species in the wetland that cover at least 10 ft <sup>2</sup> (different patches of the same species can be combined to meet the size threshold) You do not have to name the species. Do not include Eurasian Milfoil, reed canarygrass, purple loosestrife, Canadian Thistle. If you counted: <table style="display: inline-table; vertical-align: middle; margin-left: 20px;"> <tr> <td>&gt; 19 species.....</td> <td>points = 2</td> </tr> <tr> <td><b>5 – 19 species.....</b></td> <td><b>points = 1</b></td> </tr> <tr> <td>&lt; 5 species.....</td> <td>points = 0</td> </tr> </table> List species below if you want to: _____ _____ _____	> 19 species.....	points = 2	<b>5 – 19 species.....</b>	<b>points = 1</b>	< 5 species.....	points = 0	1			
> 19 species.....	points = 2										
<b>5 – 19 species.....</b>	<b>points = 1</b>										
< 5 species.....	points = 0										
	H 1.4 <u>Interspersion of Habitats</u> (see p. 76): Decided from the diagrams below whether interspersion between Cowardin vegetation (described in H1.1), or the classes and unvegetated areas (can include open water or mudflats) is high, medium, low, or none. <div style="display: flex; justify-content: space-around; align-items: flex-start; margin-top: 10px;"> <div style="text-align: center;"> <p>None = 0 points</p> </div> <div style="text-align: center;"> <p>Low = 1 point</p> </div> <div style="text-align: center;"> <p>Moderate = 2 points</p> </div> <div style="text-align: center;"> <p>High = 3 points</p> </div> <div style="text-align: center;"> <p>[riparian braided channels]</p> </div> </div>	Note: If you have 4 or more classes or 3 vegetation classes and open water, the rating is always “high”.  <b>Use map of Cowardin classes.</b>	1								
	H 1.5 <u>Special Habitat Features</u> (see p. 77): Check the habitat features that are present in the wetland. The number of checks is the number of points you put into the next column. <ul style="list-style-type: none"> <li><input type="checkbox"/> Large, downed, woody debris within the wetland (&gt; 4 in. diameter and 6 ft. long)</li> <li><input type="checkbox"/> Standing snags (diameter at the bottom &gt; 4 inches) in the wetland</li> <li><input type="checkbox"/> Undercut banks are present for at least 6.6 ft. (2m) and/or overhanging vegetation extends at least 3.3 ft. (1m) over a stream (or ditch) in, or contiguous with the unit, for at least 33 ft. (10m)</li> <li><input type="checkbox"/> Stable steep banks of fine material that might be used by beaver or muskrat for denning (&gt; 30 degree slope) OR signs of recent beaver activity are present (<i>cut shrubs or trees that have not yet turned grey/brown</i>)</li> <li><input type="checkbox"/> At least 1/4 acre of thin-stemmed persistent vegetation or woody branches are present in areas that are permanently or seasonally inundated (<i>structures for egg-laying by amphibians</i>)</li> <li><input type="checkbox"/> Invasive plants cover less than 25% of the wetland area in each stratum of plants</li> </ul> NOTE: The 20% stated in early printings of the manual on page 78 is an error.	0									
<b>H 1 TOTAL Score – potential for providing habitat</b>		<b>4</b>									

Exhibit 16  
 SSDP2016-00415  
 001070

H 2	Does the wetland have the <u>opportunity</u> to provide habitat for many species?	(only 1 score per box)
	<p>H 2.1 <u>Buffers</u> (<i>see P. 80</i>):  <i>Choose the description that best represents condition of buffer of wetland unit. The highest scoring criterion that applies to the wetland is to be used in the rating. See text for definition of “undisturbed”.</i></p> <p> <input type="checkbox"/> 100m (330 ft) of relatively undisturbed vegetated areas, rocky areas, or open water &gt; 95% of circumference. No structures are within the undisturbed part of buffer (relatively undisturbed also means no grazing, no landscaping, no daily human use)..... <b>points = 5</b>  <input type="checkbox"/> 100m (330 ft) of relatively undisturbed vegetated areas, rocky areas, or open water &gt; 50% circumference ..... <b>points = 4</b>  <input type="checkbox"/> 50m (170 ft) of relatively undisturbed vegetated areas, rocky areas, or open water &gt; 95% circumference ..... <b>points = 4</b>  <input type="checkbox"/> 100m (330 ft) of relatively undisturbed vegetated areas, rocky areas, or open water &gt; 25% circumference ..... <b>points = 3</b>  <input type="checkbox"/> 50m (170 ft) of relatively undisturbed vegetated areas, rocky areas, or open water for &gt; 50% circumference ..... <b>points = 3</b> </p> <p><b>If buffer does not meet any of the criteria above:</b></p> <p> <input type="checkbox"/> No paved areas (except paved trails) or buildings within 25m (80 ft) of wetland &gt; 95% circumference. Light to moderate grazing or lawns are OK ..... <b>points = 2</b>  <input type="checkbox"/> No paved areas of buildings within 50m of wetland for &gt; 50% circumference. Light to moderate grazing or lawns are OK..... <b>points = 2</b>  <input type="checkbox"/> Heavy grazing in buffer ..... <b>points = 1</b>  <input type="checkbox"/> Vegetated buffers are &lt; 2m wide (6.6 ft) for more than 95% circumference (e.g. tilled fields, paving, basalt bedrock extend to edge of wetland) ..... <b>points = 0</b>  <input checked="" type="checkbox"/> Buffer does not meet any of the criteria above ..... <b>points = 1</b> </p> <p style="text-align: right;"><b>Arial photo showing buffers</b></p>	<p><b>Figure</b> ____</p> <p>1</p>
	<p>H 2.2 <u>Corridors and Connections</u> (<i>see p. 81</i>)</p> <p>H 2.2.1 Is the wetland part of a relatively undisturbed and unbroken vegetated corridor (either riparian or upland) that is at least 150 ft. wide, has at least a 30% cover of shrubs, forest or native undisturbed prairie, that connects to estuaries, other wetlands or undisturbed uplands that are at least 250 acres in size? (<i>Dams in riparian corridors, heavily used gravel roads, paved roads, are considered breaks in the corridor.</i>)                      YES = <b>4 points</b> (go to H 2.3)                                 <b>NO = go to H 2.2.2</b></p> <p>H. 2.2.2 Is the wetland part of a relatively undisturbed and unbroken vegetated corridor (either riparian or upland) that is at least 50 ft. wide, has at least 30% cover of shrubs or forest, and connects to estuaries, other wetlands or undisturbed uplands that are at least 25 acres in size? <b>OR a Lake-fringe</b> wetland, if it does not have an undisturbed corridor as in the question above?                      YES = <b>2 points</b> (go to H 2.3)                                 <b>NO = go to H 2.2.3</b></p> <p>H. 2.2.3 Is the wetland:  <ul style="list-style-type: none"> <li>• Within 5 mi (8km) of a brackish or salt water estuary OR</li> <li>• Within 3 miles of a large field or pasture (&gt; 40 acres) OR                                 <b>YES = 1 point</b></li> <li>• <b>Within 1 mile of a lake greater than 20 acres?</b>                                 NO = 0 points</li> </ul> </p>	<p>1</p>

Comments:

	<p>H 2.3 <u>Near or adjacent to other priority habitats listed by WDFW</u> (see p. 82): (see new and complete descriptions of WDFW priority habitats, and the counties in which they can be found, in the PHS report <a href="http://wdfw.wa.gov/hab/phslist.htm">http://wdfw.wa.gov/hab/phslist.htm</a> )</p> <p>Which of the following priority habitats are within 330 ft. (100m) of the wetland unit?  <i>NOTE: the connections do not have to be relatively undisturbed.</i></p> <p>___ <b>Aspen Stands:</b> Pure or mixed stands of aspen greater than 0.4 ha (1 acre).</p> <p>___ <b>Biodiversity Areas and Corridors:</b> Areas of habitat that are relatively important to various species of native fish and wildlife (full descriptions in WDFW PHS report p. 152).</p> <p>___ <b>Herbaceous Balds:</b> Variable size patches of grass and forbs on shallow soils over bedrock.</p> <p>___ <b>Old-growth/Mature forests:</b> (Old-growth west of Cascade crest) Stands of at least 2 tree species, forming a multi-layered canopy with occasional small openings; with at least 20 trees/ha (8 trees/acre) &gt; 81 cm (32 in) dbh or &gt; 200 years of age. (Mature forests) Stands with average diameters exceeding 53 cm (21 in) dbh; crown cover may be less than 100%; decay, decadence, numbers of snags, and quantity of large downed material is generally less than that found in old-growth; 80 - 200 years old west of the Cascade crest.</p> <p>___ <b>Oregon white Oak:</b> Woodlands Stands of pure oak or oak/conifer associations where canopy coverage of the oak component is important (full descriptions in WDFW PHS report p. 158).</p> <p>___ <b>Riparian:</b> The area adjacent to aquatic systems with flowing water that contains elements of both aquatic and terrestrial ecosystems which mutually influence each other.</p> <p>___ <b>Westside Prairies:</b> Herbaceous, non-forested plant communities that can either take the form of a dry prairie or a wet prairie (full descriptions in WDFW PHS report p. 161).</p> <p>___ <b>Instream:</b> The combination of physical, biological, and chemical processes and conditions that interact to provide functional life history requirements for instream fish and wildlife resources.</p> <p>___ <b>Nearshore:</b> Relatively undisturbed nearshore habitats. These include Coastal Nearshore, Open Coast Nearshore, and Puget Sound Nearshore. (full descriptions of habitats and the definition of relatively undisturbed are in WDFW report: pp. 167-169 and glossary in Appendix A).</p> <p>___ <b>Caves:</b> A naturally occurring cavity, recess, void, or system of interconnected passages under the earth in soils, rock, ice, or other geological formations and is large enough to contain a human.</p> <p>___ <b>Cliffs:</b> Greater than 7.6 m (25 ft) high and occurring below 5000 ft.</p> <p>___ <b>Talus:</b> Homogenous areas of rock rubble ranging in average size 0.15 - 2.0 m (0.5 - 6.5 ft), composed of basalt, andesite, and/or sedimentary rock, including riprap slides and mine tailings. May be associated with cliffs.</p> <p>___ <b>Snags and Logs:</b> Trees are considered snags if they are dead or dying and exhibit sufficient decay characteristics to enable cavity excavation/use by wildlife. Priority snags have a diameter at breast height of &gt; 51 cm (20 in) in western Washington and are &gt; 2 m (6.5 ft) in height. Priority logs are &gt; 30 cm (12 in) in diameter at the largest end, and &gt; 6 m (20 ft) long.</p> <p>If wetland has <b>3 or more</b> priority habitats = <b>4 points</b>                  If wetland has <b>2</b> priority habitats = <b>3 points</b>                  If wetland has <b>1</b> priority habitat = <b>1 point</b>                      <b>No habitats = 0 points</b></p> <p>Note: All vegetated wetlands are by definition a priority habitat but are not included in this list. Nearby wetlands are addressed in question H 2.4)</p>	0
	<p>H 2.4 <u>Wetland Landscape:</u> Choose the <b>one</b> description of the landscape around the wetland that best fits (see p. 84)</p> <ul style="list-style-type: none"> <li>• There are at least 3 other wetlands within 1/2 mile, and the connections between them are relatively undisturbed (light grazing between wetlands OK, as is lake shore with some boating, but connections should NOT be bisected by paved roads, fill, fields, or other development.....points = 5</li> <li>• The wetland is Lake-fringe on a lake with little disturbance and there are 3 other lake-fringe wetlands within 1/2 mile .....points = 5</li> <li>• <b>There are at least 3 other wetlands within 1/2 mile, BUT the connections between them are disturbed.....points = 3</b></li> <li>• The wetland fringe on a lake <b>with</b> disturbance and there are 3 other lake-fringe wetlands within 1/2 mile .....points = 3</li> <li>• There is at least 1 wetland within 1/2 mile .....points = 2</li> <li>• There are no wetlands within 1/2 mile.....points = 0</li> </ul>	3
	<p><b>H 2 TOTAL Score</b> – opportunity for providing habitat                      Add the scores from H2.1, H2.2, H2.3, H2.4</p>	5
	<p style="text-align: right;">TOTAL for H 1 from page 8</p>	4
◆	<p><b>Total Score for Habitat Functions</b>                      Add the points for H 1 and H 2; then <b>record the result on p. 1</b></p>	9

Comments:

### CATEGORIZATION BASED ON SPECIAL CHARACTERISTICS

*Please determine if the wetland meets the attributes described below  
and circle the appropriate answers and Category.*

<b>Wetland Type</b> – Check off any criteria that apply to the wetland. Circle the Category when the appropriate criteria are met.		
<b>SC1</b>	<p><b>Estuarine wetlands?</b> (see p.86)</p> <p>Does the wetland unit meet the following criteria for Estuarine wetlands?</p> <p><input type="checkbox"/> The dominant water regime is tidal,</p> <p><input type="checkbox"/> Vegetated, and</p> <p><input type="checkbox"/> With a salinity greater than 0.5 ppt.</p> <p style="text-align: center;">YES = Go to SC 1.1                      NO = <u>X</u></p>	
SC 1.1	<p>Is the wetland unit within a National Wildlife Refuge, National Park, National Estuary Reserve, Natural Area Preserve, State Park or Educational, Environmental, or Scientific Reserve designated under WAC 332-30-151?      YES = Category I                      NO = go to SC 1.2</p>	<b>Cat. I</b>
SC 1.2	<p>Is the wetland at least 1 acre in size and meets at least two of the following conditions?</p> <p style="text-align: center;">YES = Category I                      NO = Category II</p> <p><input type="checkbox"/> The wetland is relatively undisturbed (has no diking, ditching, filling, cultivation, grazing, and has less than 10% cover of non-native plant species. If the non-native <i>Spartina</i> spp., are only species that cover more than 10% of the wetland, then the wetland should be given a dual rating (I/II). The area of <i>Spartina</i> would be rated a Category II while the relatively undisturbed upper marsh with native species would be a Category I. Do not, however, exclude the area of <i>Spartina</i> in determining the size threshold of 1 acre.</p> <p><input type="checkbox"/> At least 3/4 of the landward edge of the wetland has a 100 ft. buffer of shrub, forest, or un-grazed or un-mowed grassland</p> <p><input type="checkbox"/> The wetland has at least 2 of the following features: tidal channels, depressions with open water, or contiguous freshwater wetlands.</p>	<b>Cat. I</b>  <b>Cat. II</b>  <b>Dual Rating I/II</b>
<b>SC2</b>	<p><b>Natural Heritage Wetlands</b> (see p. 87)</p> <p>Natural Heritage wetlands have been identified by the Washington Natural Heritage Program/DNR as either high quality undisturbed wetlands or wetlands that support state Threatened, Endangered, or Sensitive plant species.</p> <p>SC 2.1 Is the wetland being rated in a Section/Township/Range that contains a natural heritage wetland? (<i>This question is used to screen out most sites before you need to contact WNHP/DNR.</i>)</p> <p style="text-align: center;">S/T/R information from Appendix D _____ or accessed from WNHP/DNR web site _____</p> <p style="text-align: center;">YES _____ Contact WNHP/DNR (see p. 79) and go to SC 2.2      NO = <u>X</u></p> <p>SC 2.2 Has DNR identified the wetland as a high quality undisturbed wetland or as a site with state threatened or endangered plant species?</p> <p style="text-align: center;">YES = Category 1                      NO _____ not a Heritage Wetland</p>	<b>Cat I</b>
<b>SC3</b>	<p><b>Bogs</b> (see p. 87)</p> <p>Does the wetland (<b>or any part of the unit</b>) meet both the criteria for soils and vegetation in bogs? Use the key below to identify if the wetland is a bog. <i>If you answer yes you will still need to rate the wetland based on its function.</i></p> <ol style="list-style-type: none"> <li>1. Does the unit have organic soil horizons (i.e. layers of organic soil), either peats or mucks, that compose 16 inches or more of the first 32 inches of soil profile? (See Appendix B for a field key to identify organic soils)?      YES = go to question 3      <b>NO = go to question 2</b></li> <li>2. Does the wetland have organic soils, either peats or mucks that are less than 16 inches deep over bedrock, or an impermeable hardpan such as clay or volcanic ash, or that are floating on a lake or pond?      YES = go to question 3      <b>NO = is not a bog for purpose of rating</b></li> <li>3. Does the unit have more than 70% cover of mosses at ground level, AND other plants, if present, consist of the “bog” species listed in Table 3 as a significant component of the vegetation (more than 30% of the total shrub and herbaceous cover consists of species in Table 3)?</li> </ol> <p style="text-align: center;">YES = Is a bog for purpose of rating      NO = go to question 4</p> <p>NOTE: If you are uncertain about the extent of mosses in the understory you may substitute that criterion by measuring the pH of the water that seeps into a hole dug at least 16” deep. If the pH is less than 5.0 and the “bog” plant species in Table 3 are present, the wetland is a bog.</p> <ol style="list-style-type: none"> <li>4. Is the unit forested (&gt; 30% cover) with sitka spruce, subalpine fir, western red cedar, western hemlock, lodgepole pine, quaking aspen, Englemann’s spruce, or western white pine. WITH any of the species (or combination of species) on the bog species plant list in Table 3 as a significant component of the ground cover (&gt; 30% coverage of the total shrub/herbaceous cover)?</li> </ol> <p style="text-align: center;">YES = Category I                      NO = Is not a bog for purpose of rating</p>	<b>Cat. I</b>

**Exhibit 16**  
**SSDP2016-00415**  
**001073**

<p><b>SC4</b></p>	<p><b>Forested Wetlands</b> (see p. 90)                  Does the wetland have at least 1 acre of forest that meet one of these criteria for the Department of Fish and Wildlife's forests as priority habitats? <i>If you answer yes you will still need to rate the wetland based on its function.</i>                  ___ <b>Old-growth forests:</b> (west of Cascade Crest) Stands of at least two three species forming a multi-layered canopy with occasional small openings; with at least 8 trees/acre (20 trees/hectare) that are at least 200 years of age OR have a diameter at breast height (dbh) of 32 inches (81 cm or more).                  NOTE: The criterion for dbh is based on measurements for upland forests. Two-hundred year old trees in wetlands will often have a smaller dbh because their growth rates are often slower. The DFW criterion is and "OR" so old-growth forests do not necessarily have to have trees of this diameter.                  ___ <b>Mature forests:</b> (west of the Cascade Crest) Stands where the largest trees are 80 – 200 years old OR have an average diameters (dbh) exceeding 21 inches (53 cm); crown cover may be less than 100%; decay, decadence, numbers of snags, and quantity of large downed material is generally less than that found in old-growth.                  YES = Category I                      NO = <u>X</u> not a forested wetland with special characteristics</p>	<p><b>Cat. I</b></p>
<p><b>SC5</b></p>	<p><b>Wetlands in Coastal Lagoons</b> (see p. 91)                  Does the wetland meet all of the following criteria of a wetland in a coastal lagoon?                  ___ The wetland lies in a depression adjacent to marine waters that is wholly or partially separated from marine waters by sandbanks, gravel banks, shingle, or, less frequently, rocks.                  ___ The lagoon in which the wetland is located contains surface water that is saline or brackish (&gt; 0.5 ppt) during most of the year in at least a portion of the lagoon (<i>needs to be measured near the bottom.</i>)                  YES = Go to SC 5.1                      NO <u>X</u> not a wetland in a coastal lagoon                  SC 5.1 Does the wetland meet all of the following three conditions?                  ___ The wetland is relatively undisturbed (has no diking, ditching, filling, cultivation, grazing) and has less than 20% cover of invasive plant species (see list of invasive species on p. 74).                  ___ At least 3/4 of the landward edge of the wetland has a 100 ft. buffer of shrub, forest, or un-grazed or un-mowed grassland.                  ___ The wetland is larger than 1/10 acre (4350 square ft.)                  YES = Category I                      NO = Category II</p>	<p><b>Cat. I</b>  <b>Cat. II</b></p>
<p><b>SC6</b></p>	<p><b>Interdunal Wetlands</b> (see p. 93)                  Is the wetland west of the 1889 line (also called the Western Boundary of Upland Ownership or WBUO)?                  YES = Go to SC 6.1                      NO <u>X</u> not an interdunal wetland for rating  <i>If you answer yes you will still need to rate the wetland based on its functions.</i>                  In practical terms that means the following geographic areas:                  • Long Beach Peninsula -- lands west of SR 103                  • Grayland-Westport -- lands west of SR 105                  • Ocean Shores-Copalis – lands west of SR 115 and SR 109                  SC 6.1 Is the wetland one acre or larger, or is it in a mosaic of wetlands that is one acre or larger?                  YES = Category II                      NO = go to SC 6.2                  SC 6.2 Is the wetland between 0.1 and 1 acre, or is it in a mosaic of wetlands that is between 0.1 and 1 acre?                  YES = Category III</p>	<p><b>Cat. II</b>  <b>Cat. III</b></p>
<p>◆</p>	<p><b>Category of wetland based on Special Characteristics</b>                  Choose the "highest" rating if wetland falls into several categories, and record on p. 1.                  If you answered NO for all types enter "Not Applicable" on p. 1</p>	<p><b>NA</b></p>

**Comments:**

Wetland name or number 22E

**WETLAND RATING FORM – WESTERN WASHINGTON**  
Version 2 – Updated July 2006 to increase accuracy and reproducibility among users  
Updated Oct. 2008 with the new WDFW definitions for priority habitats

Name of wetland (if known): 22E Date of site visit: 10-25-13

Rated by: Colin Worsley / Matt Maynard Trained by Ecology? Yes X No      Date of training: 11-2005 / 04-2006

SEC: 06 TOWNSHIP: 24N RANGE: 06E Is S/T/R in Appendix D? Yes      No X

Map of wetland unit: Figure      Estimated size <0.01 acre

**SUMMARY OF RATING**

Category based on FUNCTIONS provided by wetland: I      II      III      IV X

Category I =	Score > 70
Category II =	Score 51 - 69
Category III =	Score 30 – 50
Category IV =	Score < 30

Score for Water Quality Functions	8
Score for Hydrologic Functions	9
Score for Habitat Functions	9
<b>TOTAL Score for Functions</b>	<b>26</b>

Category based on SPECIAL CHARACTERISTICS of Wetland I      II      Does not apply X

**Final Category** (choose the “highest” category from above”) **IV**

**Summary of basic information about the wetland unit.**

Wetland Unit has Special Characteristics		Wetland HGM Class used for Rating	
<b>Estuarine</b>		<b>Depressional</b>	<b>X</b>
<b>Natural Heritage Wetland</b>		<b>Riverine</b>	
<b>Bog</b>		<b>Lake-fringe</b>	
<b>Mature Forest</b>		<b>Slope</b>	
<b>Old Growth Forest</b>		<b>Flats</b>	
<b>Coastal Lagoon</b>		<b>Freshwater Tidal</b>	
<b>Interdunal</b>			
None of the above	X	Check if unit has multiple HGM classes present	<span style="border: 1px solid black; padding: 2px 10px;">    </span>

**Does the wetland being rated meet any of the criteria below?** If you answer YES to any of the questions below you will need to protect the wetland according to the regulations regarding the special characteristics found in the wetland.

Check List for Wetlands that Need Additional Protection (in addition to the protection recommended for its category)	YES	NO
SP1. <i>Has the wetland unit been documented as a habitat for any Federally listed Threatened or Endangered <b>animal or plant</b> species (T/E species)?</i> For the purposes of this rating system, “documented” means the wetland is on the appropriate state or federal database.		X
SP2. <i>Has the wetland unit been documented as habitat for any State listed Threatened or Endangered <b>animal</b> species?</i> For the purposes of this rating system, “documented” means the wetland is on the appropriate state database. Note: Wetlands with State listed plant species are categorized as Category 1 Natural Heritage Wetlands (see p. 19 of data form).		X
SP3. <i>Does the wetland unit contain individuals of Priority species listed by the WDFW for the state?</i>		X
SP4. <i>Does the wetland unit have a local significance in addition to its functions?</i> For example, the wetland has been identified in the Shoreline Master Program, the Critical Areas Ordinance, or in a local management plan as having special significance.		X

To complete the next part of the data sheet you will need to determine the Hydrogeomorphic Class of the wetland being rated.

Exhibit 16  
SSDP2016-00415  
001075



### Classification of Vegetated Wetlands for Western Washington

If the hydrologic criteria listed in each question do not apply to the entire unit being rated, you probably have a unit with multiple HGM classes. In this case, identify which hydrologic criteria in questions 1-7 apply, and go to Question 8.

1. Are the water levels in the entire unit usually controlled by tides (i.e. except during floods)?  
NO – go to 2                      **YES – the wetland class is Tidal Fringe**  
 If yes, is the salinity of the water during periods of annual low flow below 0.5 ppt (parts per thousand)?  
**YES – Freshwater Tidal Fringe**                      **NO – Saltwater Tidal Fringe (Estuarine)**  
*If your wetland can be classified as a Freshwater Tidal Fringe use the forms for Riverine wetlands. If it is a Saltwater Tidal Fringe it is rated as an Estuarine wetland. Wetlands that were call estuarine in the first and second editions of the rating system are called Salt Water Tidal Fringe in the Hydrogeomorphic Classification. Estuarine wetlands were categorized separately in the earlier editions, and this separation is being kept in this revision. To maintain consistency between editions, the term “Estuarine” wetland is kept. Please note, however, that the characteristics that define Category I and II estuarine wetlands have changed (see p. \_\_\_\_).*

---

2. The entire wetland unit is flat and precipitation is only source (>90%) of water to it. Groundwater and surface water runoff are NOT sources of water to the unit.  
NO – go to 3                      **YES – The wetland class is Flats**  
 If your wetland can be classified as a “Flats” wetland, use the form for **Depressional** wetlands.

---

3. Does the entire wetland meet both of the following criteria?  
 \_\_\_\_\_ The vegetated part of the wetland is on the shores of a body of permanent open water (without any vegetation on the surface) where at least 20 acres (8ha) in size;  
 \_\_\_\_\_ At least 30% of the open water area is deeper than 6.6 (2 m)?  
NO – go to 4                      **YES – The wetland class is Lake-fringe (Lacustrine Fringe)**

---

4. Does the entire wetland meet all of the following criteria?  
 \_\_\_\_\_ The wetland is on a slope (*slope can be very gradual*).  
 \_\_\_\_\_ The water flows through the wetland in one direction (unidirectional) and usually comes from seeps. It may flow subsurface, as sheetflow, or in a swale without distinct banks.  
 \_\_\_\_\_ The water leaves the wetland **without being impounded**?  
 NOTE: *Surface water does not pond in these types of wetlands except occasionally in very small and shallow depressions or behind hummocks (depressions are usually <3 ft diameter and less than 1 foot deep).*  
NO – go to 5                      **YES – The wetland class is Slope**

---

5. Does the entire wetland meet all of the following criteria?  
 \_\_\_\_\_ The unit is in a valley or stream channel where it gets inundated by overbank flooding from that stream or river.  
 \_\_\_\_\_ The overbank flooding occurs at least once every two years.  
 NOTE: *The riverine unit can contain depressions that are filled with water when the river is not flooding..*  
NO – go to 6                      **YES – The wetland class is Riverine**

---

6. Is the entire wetland unit in a topographic depression in which water ponds, or is saturated to the surface, at some time of the year. This means that any outlet, if present is higher than the interior of the wetland.  
NO – go to 7                      **YES – The wetland class is Depressional**

---

7. Is the entire wetland located in a very flat area with no obvious depression and no overbank flooding. The unit does not pond surface water more than a few inches. The unit seems to be maintained by high groundwater in the area. The wetland may be ditched, but has no obvious natural outlet.  
No – go to 8                      **YES – The wetland class is Depressional**

---

8. Your wetland unit seems to be difficult to classify and probably contains several different HGM classes. For example, seeps at the base of a slope may grade into a riverine floodplain, or a small stream within a depressional wetland has a zone of flooding along its sides. **GO BACK AND IDENTIFY WHICH OF THE HYDROLOGIC REGIMES DESCRIBED IN QUESTIONS 1-7 APPLY TO DIFFERENT AREAS IN THE UNIT** (make a rough sketch to help you decide). Use the following table to identify the appropriate class to use for the rating system if you have several HGM classes present within your wetland. NOTE: Use this table only if the class that is recommended in the second column represents 10% or more of the total area of the wetland unit being rated. If the area of the class listed in column 2 is less than 10% of the unit, classify the wetland using the class that represents more than 90% of the total area.

HGM Classes within the wetland unit being rated	HGM Class to Use in Rating
Slope + Riverine	Riverine
Slope + Depressional	Depressional
Slope + Lake-fringe	Lake-fringe
Depressional + Riverine along stream within boundary	Depressional
Depressional + Lake-fringe	Depressional
Salt Water Tidal Fringe and any other class of freshwater wetland	Treat as ESTUARINE under wetlands with special characteristics

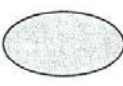
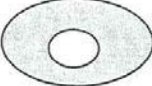

**Exhibit 16**  
**SSDP2016-00415**  
**001076**

If you are unable still to determine which of the above criteria apply to your wetland, or you have more than 2 HGM classes within a wetland boundary, classify the wetland as **Depressional** for the rating.

<b>D Depressional and Flat Wetlands</b>		<b>Points</b>
WATER QUALITY FUNCTIONS – Indicators that wetland functions to improve water quality.		(only 1 score per box) <i>(see p.38)</i>
<b>D 1</b>	<b>Does the wetland have the <u>potential</u> to improve water quality?</b>	
D 1.1	Characteristics of surface water flows out of the wetland: <ul style="list-style-type: none"> <li>• Unit is a depression with no surface water leaving it (no outlet)..... points = 3</li> <li>• Unit has an intermittently flowing, OR highly constricted, permanently flowing outlet ..... points = 2</li> <li>• Unit has an unconstricted, or slightly constricted, surface outlet (<i>permanently flowing</i>) ..... points = 1</li> <li>• Unit is a “flat” depression (Q.7 on key), or in the Flats class, with permanent surface outflow <b>and no obvious natural outlet</b> and/or outlet is a man-made ditch..... points = 1 (<i>If ditch is not permanently flowing treat unit as “intermittently flowing”</i>) <b>Provide photo or drawing</b></li> </ul>	Figure ___ 3
D 1.2	The soil 2 inches below the surface (or duff layer) is clay or organic ( <i>use NRCS definitions</i> ) YES points = 4 <b>NO points = 0</b>	0
D 1.3	Characteristics of persistent vegetation (emergent, shrub, and/or forest Cowardin class): <ul style="list-style-type: none"> <li>• Wetland has persistent, ungrazed vegetation &gt; = 95% of area..... points = 5</li> <li>• Wetland has persistent, ungrazed vegetation &gt; = 1/2 of area..... points = 3</li> <li>• Wetland has persistent, ungrazed vegetation &gt; = 1/10 of area..... points = 1</li> <li>• Wetland has persistent, ungrazed vegetation &lt; 1/10 of area..... points = 0</li> </ul> <b>Map of Cowardin vegetation classes</b>	Figure ___ 5
D 1.4	Characteristics of seasonal ponding or inundation: <i>This is the area of the wetland that is ponded for at least 2 months, but dries out sometime during the year. Do not count the area that is permanently ponded. Estimate area as the average condition 5 out of 10 years.</i> <ul style="list-style-type: none"> <li>• Area seasonally ponded is &gt; 1/2 total area of wetland ..... points = 4</li> <li>• Area seasonally ponded is &gt; 1/4 total area of wetland ..... points = 2</li> <li>• Area seasonally ponded is &lt; 1/4 total area of wetland ..... points = 0</li> </ul> <b>Map of Hydroperiods</b>	Figure ___ 0
<b>Total for D 1</b>		<i>Add the points in the boxes above</i> <b>8</b>
<b>D 2</b>	<b>Does the wetland have the <u>opportunity</u> to improve water quality?</b> Answer YES if you know or believe there are pollutants in groundwater or surface water coming into the wetland that would otherwise reduce water quality in streams, lakes or groundwater downgradient from the wetland? <i>Note which of the following conditions provide the sources of pollutants. A unit may have pollutants coming from several sources, but any single source would qualify as opportunity.</i> ___ Grazing in the wetland or within 150 ft ___ Untreated stormwater discharges to wetland ___ Tilled fields or orchards within 150 ft. of wetland ___ A stream or culvert discharges into wetland that drains developed areas, residential areas, farmed fields, roads, or clear-cut logging ___ Residential, urban areas, golf courses are within 150 ft. of wetland ___ Wetland is fed by groundwater high in phosphorus or nitrogen ___ Other _____ YES multiplier is 2 <b>NO multiplier is 1</b>	<i>(see p. 44)</i>  Multiplier X1
<b>◆ TOTAL – Water Quality Functions</b> Multiply the score from D1 by D2; then <b>add score to table on p. 1</b>		<b>8</b>
HYDROLOGIC FUNCTIONS – Indicators that wetland unit functions to reduce flooding and stream degradation.		
<b>D 3</b>	<b>Does the wetland have the <u>potential</u> to reduce flooding and erosion?</b>	<i>(see p.46)</i>
D 3.1	Characteristics of surface water flows out of the wetland unit <ul style="list-style-type: none"> <li>• Unit is a depression with no surface water leaving it (no outlet)..... points = 4</li> <li>• Unit has an intermittently flowing, OR highly constricted permanently flowing outlet ..... points = 2</li> <li>• Unit is a “flat” depression (Q.7 on key) or in the Flats class, with permanent surface outflow <b>and no obvious natural outlet</b> and/or outlet is a man-made ditch..... points = 1 (<i>If ditch is not permanently flowing treat unit as “intermittently flowing”</i>)</li> <li>• Unit has an unconstricted, or slightly constricted, surface outlet (<i>permanently flowing</i>) ..... points = 0</li> </ul>	4
D 3.2	Depth of storage during wet periods. <i>Estimate the height of ponding above the bottom of the outlet. For units with no outlet measure from the surface of permanent water or deepest part (if dry).</i> <ul style="list-style-type: none"> <li>• Marks of ponding are 3 ft. or more above the surface or bottom of the outlet ..... points = 7</li> <li>• The wetland is a “headwater” wetland..... points = 5</li> <li>• Marks of ponding between 2 ft. to &lt; 3 ft. from surface or bottom of outlet ..... points = 5</li> <li>• Marks are at least 0.5 ft. to &lt; 2 ft. from surface or bottom of outlet ..... points = 3</li> <li>• Wetland is flat (yes to Q.2 or Q.7 on key)but has small depressions on the surface that trap water points = 1</li> <li>• <b>Marks of ponding less than 0.5 ft..... points = 0</b></li> </ul>	0
D 3.3	Contribution of wetland unit to storage in the watershed: <i>Estimate the ratio of the area of upstream basin contributing surface water to the wetland to the area of the wetland unit itself.</i> <ul style="list-style-type: none"> <li>• <b>The area of the basin is less than 10 times the area of unit..... points = 5</b></li> <li>• The area of the basin is 10 to 100 times the area of the unit ..... points = 3</li> <li>• The area of the basin is more than 100 times the area of the unit ..... points = 0</li> <li>• Entire unit is in the FLATS class ..... points = 5</li> </ul>	5
<b>Total for D 3</b>		<i>Add the points in the boxes above</i> <b>9</b>

<b>D 4</b>	<p><b>Does the wetland have the <u>opportunity</u> to reduce flooding and erosion?</b></p> <p>Answer YES if the unit is in a location in the watershed where the flood storage, or reduction in water velocity, it provides helps protect downstream property and aquatic resources from flooding or excessive and/or erosive flows. Answer NO if the water coming into the wetland is controlled by a structure such as flood gate, tide gate, flap valve, reservoir etc. OR you estimate that more than 90% of the water in the wetland is from groundwater in areas where damaging groundwater flooding does not occur. <i>Note which of the following indicators of opportunity apply.</i></p> <p><input type="checkbox"/> Wetland is in a headwater of a river or stream that has flooding problems.</p> <p><input type="checkbox"/> Wetland drains to a river or stream that has flooding problems</p> <p><input type="checkbox"/> Wetland has no outlet and impounds surface runoff water that might otherwise flow into a river or stream that has flooding problems</p> <p><input type="checkbox"/> Other _____</p> <p>YES multiplier is 2      NO multiplier is 1</p>	<p>(see p. 49)</p> <p>Multiplier</p> <p>X1</p>
◆	<p><b>TOTAL – Hydrologic Functions</b>      Multiply the score from D3 by D4; then <i>add score to table on p. 1</i></p>	<p>9</p>

Comments:

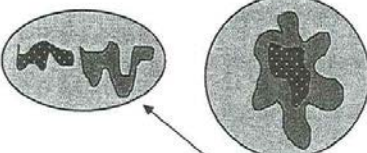
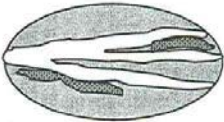
<i>These questions apply to wetlands of all HGM classes.</i> HABITAT FUNCTIONS – Indicators that wetland functions to provide important habitat.		Points (only 1 score per box)											
<b>H 1</b>	<b>Does the wetland have the <u>potential</u> to provide habitat for many species?</b>	<b>Figure</b> ____											
	H 1.1 <u>Vegetation structure</u> (see P. 72): Check the types of vegetation classes present (as defined by Cowardin) – Size threshold for each class is 1/4 acre or more than 10% of the area if unit is smaller than 2.5 acres. <input type="checkbox"/> Aquatic Bed <input checked="" type="checkbox"/> Emergent plants <input type="checkbox"/> Scrub/shrub (areas where shrubs have > 30% cover) <input type="checkbox"/> Forested (areas where trees have > 30% cover) If the unit has a forested class check if: <input type="checkbox"/> The forested class has 3 out of 5 strata (canopy, sub-canopy, shrubs, herbaceous, moss/ground-cover) that each cover 20% within the forested polygon. Add the number of vegetation types that qualify. If you have: <table style="margin-left: 20px;"> <tr> <td>4 structures or more.....</td> <td>points = 4</td> <td><b>Map of Cowardin vegetation classes</b></td> </tr> <tr> <td>3 structures.....</td> <td>points = 2</td> <td>3 structures.....</td> <td>points = 2</td> </tr> <tr> <td>2 structures.....</td> <td>points = 1</td> <td>1 structure.....</td> <td>points = 0</td> </tr> </table>	4 structures or more.....	points = 4	<b>Map of Cowardin vegetation classes</b>	3 structures.....	points = 2	3 structures.....	points = 2	2 structures.....	points = 1	1 structure.....	points = 0	0
4 structures or more.....	points = 4	<b>Map of Cowardin vegetation classes</b>											
3 structures.....	points = 2	3 structures.....	points = 2										
2 structures.....	points = 1	1 structure.....	points = 0										
	H 1.2 <u>Hydroperiods</u> (see p.73): Check the types of water regimes (hydroperiods) present within the wetland. The water regime has to cover more than 10% of the wetland or 1/4 acre to count (see text for descriptions of hydroperiods). <input type="checkbox"/> Permanently flooded or inundated <input type="checkbox"/> Seasonally flooded or inundated <input type="checkbox"/> Occasionally flooded or inundated <input checked="" type="checkbox"/> Saturated only <input type="checkbox"/> Permanently flowing stream or river in, or adjacent to, the wetland <input type="checkbox"/> Seasonally flowing stream in, or adjacent to, the wetland <input type="checkbox"/> <b>Lake-fringe wetland..... = 2 points</b> <input type="checkbox"/> <b>Freshwater tidal wetland..... = 2 points</b>	0											
	H 1.3 <u>Richness of Plant Species</u> (see p. 75): Count the number of plant species in the wetland that cover at least 10 ft <sup>2</sup> (different patches of the same species can be combined to meet the size threshold) You do not have to name the species. Do not include Eurasian Milfoil, reed canarygrass, purple loosestrife, Canadian Thistle. If you counted: <table style="margin-left: 20px;"> <tr> <td>&gt; 19 species.....</td> <td>points = 2</td> </tr> <tr> <td>5 – 19 species.....</td> <td>points = 1</td> </tr> <tr> <td>&lt; 5 species.....</td> <td>points = 0</td> </tr> </table> List species below if you want to: _____ _____ _____	> 19 species.....	points = 2	5 – 19 species.....	points = 1	< 5 species.....	points = 0	1					
> 19 species.....	points = 2												
5 – 19 species.....	points = 1												
< 5 species.....	points = 0												
	H 1.4 <u>Interspersion of Habitats</u> (see p. 76): Decided from the diagrams below whether interspersion between Cowardin vegetation (described in H1.1), or the classes and unvegetated areas (can include open water or mudflats) is high, medium, low, or none. <div style="display: flex; justify-content: space-around; align-items: flex-start;"> <div style="text-align: center;">  None = 0 points                             </div> <div style="text-align: center;">  Low = 1 point                             </div> <div style="text-align: center;">  Moderate = 2 points                             </div> <div style="text-align: center;">  High = 3 points                             </div> </div> <div style="margin-left: 20px;">  [riparian braided channels]                 </div> <div style="margin-left: 20px;"> <p>Note: If you have 4 or more classes or 3 vegetation classes and open water, the rating is always “high”.</p> <p><b>Use map of Cowardin classes.</b></p> </div>	0											
	H 1.5 <u>Special Habitat Features</u> (see p. 77): Check the habitat features that are present in the wetland. The number of checks is the number of points you put into the next column. <ul style="list-style-type: none"> <li><input type="checkbox"/> Large, downed, woody debris within the wetland (&gt; 4 in. diameter and 6 ft. long)</li> <li><input type="checkbox"/> Standing snags (diameter at the bottom &gt; 4 inches) in the wetland</li> <li><input type="checkbox"/> Undercut banks are present for at least 6.6 ft. (2m) and/or overhanging vegetation extends at least 3.3 ft. (1m) over a stream (or ditch) in, or contiguous with the unit, for at least 33 ft. (10m)</li> <li><input type="checkbox"/> Stable steep banks of fine material that might be used by beaver or muskrat for denning (&gt; 30 degree slope) OR signs of recent beaver activity are present (cut shrubs or trees that have not yet turned grey/brown)</li> <li><input type="checkbox"/> At least 1/4 acre of thin-stemmed persistent vegetation or woody branches are present in areas that are permanently or seasonally inundated (structures for egg-laying by amphibians)</li> <li><input type="checkbox"/> Invasive plants cover less than 25% of the wetland area in each stratum of plants</li> </ul> NOTE: The 20% stated in early printings of the manual on page 78 is an error.	0											
<b>H 1 TOTAL Score</b> – potential for providing habitat		Add the points in the column. <div style="float: right; color: red; font-weight: bold;">                         Exhibit 16                          SSDP2016-00415                          000079                     </div> 1											

H 2	Does the wetland have the <u>opportunity</u> to provide habitat for many species?	(only 1 score per box)
	<p>H 2.1 <u>Buffers</u> (see P. 80): Choose the description that best represents condition of buffer of wetland unit. The highest scoring criterion that applies to the wetland is to be used in the rating. See text for definition of "undisturbed".</p> <p><input type="checkbox"/> 100m (330 ft) of relatively undisturbed vegetated areas, rocky areas, or open water &gt; 95% of circumference. No structures are within the undisturbed part of buffer (relatively undisturbed also means no grazing, no landscaping, no daily human use)..... <b>points = 5</b></p> <p><input type="checkbox"/> 100m (330 ft) of relatively undisturbed vegetated areas, rocky areas, or open water &gt; 50% circumference..... <b>points = 4</b></p> <p><input type="checkbox"/> 50m (170 ft) of relatively undisturbed vegetated areas, rocky areas, or open water &gt; 95% circumference..... <b>points = 4</b></p> <p><input type="checkbox"/> 100m (330 ft) of relatively undisturbed vegetated areas, rocky areas, or open water &gt; 25% circumference..... <b>points = 3</b></p> <p><input type="checkbox"/> 50m (170 ft) of relatively undisturbed vegetated areas, rocky areas, or open water for &gt; 50% circumference..... <b>points = 3</b></p> <p><b>If buffer does not meet any of the criteria above:</b></p> <p><input type="checkbox"/> No paved areas (except paved trails) or buildings within 25m (80 ft) of wetland &gt; 95% circumference. Light to moderate grazing or lawns are OK..... <b>points = 2</b></p> <p><input type="checkbox"/> No paved areas of buildings within 50m of wetland for &gt; 50% circumference. Light to moderate grazing or lawns are OK..... <b>points = 2</b></p> <p><input type="checkbox"/> Heavy grazing in buffer..... <b>points = 1</b></p> <p><input type="checkbox"/> Vegetated buffers are &lt; 2m wide (6.6 ft) for more than 95% circumference (e.g. tilled fields, paving, basalt bedrock extend to edge of wetland)..... <b>points = 0</b></p> <p><input checked="" type="checkbox"/> Buffer does not meet any of the criteria above..... <b>points = 1</b></p> <p style="text-align: right;"><b>Arial photo showing buffers</b></p>	<p>Figure ____</p> <p style="text-align: center;">1</p>
	<p>H 2.2 <u>Corridors and Connections</u> (see p. 81)</p> <p>H 2.2.1 Is the wetland part of a relatively undisturbed and unbroken vegetated corridor (either riparian or upland) that is at least 150 ft. wide, has at least a 30% cover of shrubs, forest or native undisturbed prairie, that connects to estuaries, other wetlands or undisturbed uplands that are at least 250 acres in size? (<i>Dams in riparian corridors, heavily used gravel roads, paved roads, are considered breaks in the corridor</i>).</p> <p style="padding-left: 40px;">YES = <b>4 points</b> (go to H 2.3) <span style="margin-left: 200px;">NO = go to H 2.2.2</span></p> <p>H. 2.2.2 Is the wetland part of a relatively undisturbed and unbroken vegetated corridor (either riparian or upland) that is at least 50 ft. wide, has at least 30% cover of shrubs or forest, and connects to estuaries, other wetlands or undisturbed uplands that are at least 25 acres in size? <b>OR a Lake-fringe</b> wetland, if it does not have an undisturbed corridor as in the question above?</p> <p style="padding-left: 40px;">YES = <b>2 points</b> (go to H 2.3) <span style="margin-left: 200px;">NO = go to H 2.2.3</span></p> <p>H. 2.2.3 Is the wetland:</p> <ul style="list-style-type: none"> <li>• Within 5 mi (8km) of a brackish or salt water estuary OR</li> <li>• Within 3 miles of a large field or pasture (&gt; 40 acres) OR <span style="float: right;">YES = 1 point</span></li> <li>• Within 1 mile of a lake greater than 20 acres? <span style="float: right;">NO = 0 points</span></li> </ul>	<p style="text-align: center;">1</p>

Comments:

	<p>H 2.3 <u>Near or adjacent to other priority habitats listed by WDFW</u> (see p. 82): (see new and complete descriptions of WDFW priority habitats, and the counties in which they can be found, in the PHS report <a href="http://wdfw.wa.gov/hab/phslist.htm">http://wdfw.wa.gov/hab/phslist.htm</a> )</p> <p>Which of the following priority habitats are within 330 ft. (100m) of the wetland unit?  <i>NOTE: the connections do not have to be relatively undisturbed.</i></p> <p><input type="checkbox"/> <b>Aspen Stands:</b> Pure or mixed stands of aspen greater than 0.4 ha (1 acre).</p> <p><input type="checkbox"/> <b>Biodiversity Areas and Corridors:</b> Areas of habitat that are relatively important to various species of native fish and wildlife (full descriptions in WDFW PHS report p. 152).</p> <p><input type="checkbox"/> <b>Herbaceous Balds:</b> Variable size patches of grass and forbs on shallow soils over bedrock.</p> <p><input type="checkbox"/> <b>Old-growth/Mature forests:</b> (Old-growth west of Cascade crest) Stands of at least 2 tree species, forming a multi-layered canopy with occasional small openings; with at least 20 trees/ha (8 trees/acre) &gt; 81 cm (32 in) dbh or &gt; 200 years of age. (Mature forests) Stands with average diameters exceeding 53 cm (21 in) dbh; crown cover may be less than 100%; decay, decadence, numbers of snags, and quantity of large downed material is generally less than that found in old-growth; 80 - 200 years old west of the Cascade crest.</p> <p><input type="checkbox"/> <b>Oregon white Oak:</b> Woodlands Stands of pure oak or oak/conifer associations where canopy coverage of the oak component is important (full descriptions in WDFW PHS report p. 158).</p> <p><input checked="" type="checkbox"/> <b>Riparian:</b> The area adjacent to aquatic systems with flowing water that contains elements of both aquatic and terrestrial ecosystems which mutually influence each other.</p> <p><input type="checkbox"/> <b>Westside Prairies:</b> Herbaceous, non-forested plant communities that can either take the form of a dry prairie or a wet prairie (full descriptions in WDFW PHS report p. 161).</p> <p><input checked="" type="checkbox"/> <b>Instream:</b> The combination of physical, biological, and chemical processes and conditions that interact to provide functional life history requirements for instream fish and wildlife resources.</p> <p><input type="checkbox"/> <b>Nearshore:</b> Relatively undisturbed nearshore habitats. These include Coastal Nearshore, Open Coast Nearshore, and Puget Sound Nearshore. (full descriptions of habitats and the definition of relatively undisturbed are in WDFW report: pp. 167-169 and glossary in Appendix A).</p> <p><input type="checkbox"/> <b>Caves:</b> A naturally occurring cavity, recess, void, or system of interconnected passages under the earth in soils, rock, ice, or other geological formations and is large enough to contain a human.</p> <p><input type="checkbox"/> <b>Cliffs:</b> Greater than 7.6 m (25 ft) high and occurring below 5000 ft.</p> <p><input type="checkbox"/> <b>Talus:</b> Homogenous areas of rock rubble ranging in average size 0.15 - 2.0 m (0.5 - 6.5 ft), composed of basalt, andesite, and/or sedimentary rock, including riprap slides and mine tailings. May be associated with cliffs.</p> <p><input type="checkbox"/> <b>Snags and Logs:</b> Trees are considered snags if they are dead or dying and exhibit sufficient decay characteristics to enable cavity excavation/use by wildlife. Priority snags have a diameter at breast height of &gt; 51 cm (20 in) in western Washington and are &gt; 2 m (6.5 ft) in height. Priority logs are &gt; 30 cm (12 in) in diameter at the largest end, and &gt; 6 m (20 ft) long.</p> <p>If wetland has <b>3 or more</b> priority habitats = <b>4 points</b>  <b>If wetland has 2</b> priority habitats = <b>3 points</b>                  If wetland has <b>1</b> priority habitat = <b>1 point</b>                      No habitats = 0 points</p> <p>Note: All vegetated wetlands are by definition a priority habitat but are not included in this list. Nearby wetlands are addressed in question H 2.4)</p>	3
	<p>H 2.4 <u>Wetland Landscape:</u> Choose the <b>one</b> description of the landscape around the wetland that best fits (see p. 84)</p> <ul style="list-style-type: none"> <li>• There are at least 3 other wetlands within 1/2 mile, and the connections between them are relatively undisturbed (light grazing between wetlands OK, as is lake shore with some boating, but connections should NOT be bisected by paved roads, fill, fields, or other development.....points = 5</li> <li>• The wetland is Lake-fringe on a lake with little disturbance and there are 3 other lake-fringe wetlands within 1/2 mile .....points = 5</li> <li>• <b>There are at least 3 other wetlands within 1/2 mile, BUT the connections between them are disturbed.....points = 3</b></li> <li>• The wetland fringe on a lake <b>with</b> disturbance and there are 3 other lake-fringe wetlands within 1/2 mile .....points = 3</li> <li>• There is at least 1 wetland within 1/2 mile .....points = 2</li> <li>• There are no wetlands within 1/2 mile.....points = 0</li> </ul>	3
<b>H 2 TOTAL Score – opportunity for providing habitat</b> <i>Add the scores from H2.1, H2.2, H2.3, H2.4</i>		8
<i>TOTAL for H 1 from page 8</i>		1
<b>◆</b>	<b>Total Score for Habitat Functions</b> Add the points for H 1 and H 2; then <b>record the result on p. 1</b>	9

Comments:

### CATEGORIZATION BASED ON SPECIAL CHARACTERISTICS

*Please determine if the wetland meets the attributes described below and circle the appropriate answers and Category.*

<b>Wetland Type</b> – Check off any criteria that apply to the wetland. Circle the Category when the appropriate criteria are met.		
<b>SC1</b>	<p><b><u>Estuarine wetlands?</u></b> (see p.86)</p> <p>Does the wetland unit meet the following criteria for Estuarine wetlands?</p> <p><input type="checkbox"/> The dominant water regime is tidal,  <input type="checkbox"/> Vegetated, and  <input type="checkbox"/> With a salinity greater than 0.5 ppt.</p> <p>YES = Go to SC 1.1                      NO <u><b>X</b></u></p>	
	<p>SC 1.1 Is the wetland unit within a National Wildlife Refuge, National Park, National Estuary Reserve, Natural Area Preserve, State Park or Educational, Environmental, or Scientific Reserve designated under WAC 332-30-151?     YES = Category I                      NO = go to SC 1.2</p>	<b>Cat. 1</b>
	<p>SC 1.2 Is the wetland at least 1 acre in size and meets at least two of the following conditions?</p> <p>YES = Category I                      NO = Category II</p> <p><input type="checkbox"/> The wetland is relatively undisturbed (has no diking, ditching, filling, cultivation, grazing, and has less than 10% cover of non-native plant species. If the non-native <i>Spartina</i> spp., are only species that cover more than 10% of the wetland, then the wetland should be given a dual rating (I/II). The area of <i>Spartina</i> would be rated a Category II while the relatively undisturbed upper marsh with native species would be a Category I. Do not, however, exclude the area of <i>Spartina</i> in determining the size threshold of 1 acre.</p> <p><input type="checkbox"/> At least 3/4 of the landward edge of the wetland has a 100 ft. buffer of shrub, forest, or un-grazed or un-mowed grassland</p> <p><input type="checkbox"/> The wetland has at least 2 of the following features: tidal channels, depressions with open water, or contiguous freshwater wetlands.</p>	<p><b>Cat. I</b></p> <p><b>Cat. II</b></p> <p><b>Dual Rating I/II</b></p>
<b>SC2</b>	<p><b><u>Natural Heritage Wetlands</u></b> (see p. 87)</p> <p>Natural Heritage wetlands have been identified by the Washington Natural Heritage Program/DNR as either high quality undisturbed wetlands or wetlands that support state Threatened, Endangered, or Sensitive plant species.</p> <p>SC 2.1 Is the wetland being rated in a Section/Township/Range that contains a natural heritage wetland? (This question is used to screen out most sites before you need to contact WNHP/DNR.)  S/T/R information from Appendix D _____ or accessed from WNHP/DNR web site _____  YES _____ Contact WNHP/DNR (see p. 79) and go to SC 2.2                      NO <u><b>X</b></u></p> <p>SC 2.2 Has DNR identified the wetland as a high quality undisturbed wetland or as a site with state threatened or endangered plant species?  YES = Category 1                      NO _____ not a Heritage Wetland</p>	<p><b>Cat I</b></p>
<b>SC3</b>	<p><b><u>Bogs</u></b> (see p. 87)</p> <p>Does the wetland (<b>or any part of the unit</b>) meet both the criteria for soils and vegetation in bogs? Use the key below to identify if the wetland is a bog. <i>If you answer yes you will still need to rate the wetland based on its function.</i></p> <p>1. Does the unit have organic soil horizons (i.e. layers of organic soil), either peats or mucks, that compose 16 inches or more of the first 32 inches of soil profile? (See Appendix B for a field key to identify organic soils)?     YES = go to question 3     <b>NO = go to question 2</b></p> <p>2. Does the wetland have organic soils, either peats or mucks that are less than 16 inches deep over bedrock, or an impermeable hardpan such as clay or volcanic ash, or that are floating on a lake or pond?     YES = go to question 3     <b>NO = is not a bog for purpose of rating</b></p> <p>3. Does the unit have more than 70% cover of mosses at ground level, AND other plants, if present, consist of the "bog" species listed in Table 3 as a significant component of the vegetation (more than 30% of the total shrub and herbaceous cover consists of species in Table 3)?  YES = Is a bog for purpose of rating                      NO = go to question 4</p> <p>NOTE: If you are uncertain about the extent of mosses in the understory you may substitute that criterion by measuring the pH of the water that seeps into a hole dug at least 16" deep. If the pH is less than 5.0 and the "bog" plant species in Table 3 are present, the wetland is a bog.</p> <p>4. Is the unit forested (&gt; 30% cover) with sitka spruce, subalpine fir, western red cedar, western hemlock, lodgepole pine, quaking aspen, Englemann's spruce, or western white pine. WITH any of the species (or combination of species) on the bog species plant list in Table 3 as a significant component of the ground cover (&gt; 30% coverage of the total shrub/herbaceous cover)?  YES = Category I                      NO = Is not a bog for purpose of rating</p>	<b>Cat. I</b>

**Exhibit 16**  
**SSDP2016-00415**  
**001082**

<p><b>SC4</b></p>	<p><b>Forested Wetlands</b> (see p. 90)                  Does the wetland have at least 1 acre of forest that meet one of these criteria for the Department of Fish and Wildlife's forests as priority habitats? <i>If you answer yes you will still need to rate the wetland based on its function.</i></p> <p>___ <b>Old-growth forests:</b> (west of Cascade Crest) Stands of at least two three species forming a multi-layered canopy with occasional small openings; with at least 8 trees/acre (20 trees/hectare) that are at least 200 years of age OR have a diameter at breast height (dbh) of 32 inches (81 cm or more).</p> <p>NOTE: The criterion for dbh is based on measurements for upland forests. Two-hundred year old trees in wetlands will often have a smaller dbh because their growth rates are often slower. The DFW criterion is and "OR" so old-growth forests do not necessarily have to have trees of this diameter.</p> <p>___ <b>Mature forests:</b> (west of the Cascade Crest) Stands where the largest trees are 80 – 200 years old OR have an average diameters (dbh) exceeding 21 inches (53 cm); crown cover may be less than 100%; decay, decadence, numbers of snags, and quantity of large downed material is generally less than that found in old-growth.</p> <p>YES = Category I                      NO = <u>X</u> not a forested wetland with special characteristics</p>	<p><b>Cat. I</b></p>
<p><b>SC5</b></p>	<p><b>Wetlands in Coastal Lagoons</b> (see p. 91)                  Does the wetland meet all of the following criteria of a wetland in a coastal lagoon?</p> <p>___ The wetland lies in a depression adjacent to marine waters that is wholly or partially separated from marine waters by sandbanks, gravel banks, shingle, or, less frequently, rocks.</p> <p>___ The lagoon in which the wetland is located contains surface water that is saline or brackish (&gt; 0.5 ppt) during most of the year in at least a portion of the lagoon (<i>needs to be measured near the bottom.</i>)</p> <p>YES = Go to SC 5.1                      NO <u>X</u> not a wetland in a coastal lagoon</p> <p>SC 5.1 Does the wetland meet all of the following three conditions?</p> <p>___ The wetland is relatively undisturbed (has no diking, ditching, filling, cultivation, grazing) and has less than 20% cover of invasive plant species (see list of invasive species on p. 74).</p> <p>___ At least 3/4 of the landward edge of the wetland has a 100 ft. buffer of shrub, forest, or un-grazed or un-mowed grassland.</p> <p>___ The wetland is larger than 1/10 acre (4350 square ft.)</p> <p>YES = Category I                      NO = Category II</p>	<p><b>Cat. I</b></p> <p><b>Cat. II</b></p>
<p><b>SC6</b></p>	<p><b>Interdunal Wetlands</b> (see p. 93)                  Is the wetland west of the 1889 line (also called the Western Boundary of Upland Ownership or WBUO)?</p> <p>YES = Go to SC 6.1                      NO <u>X</u> not an interdunal wetland for rating</p> <p><b><i>If you answer yes you will still need to rate the wetland based on its functions.</i></b></p> <p>In practical terms that means the following geographic areas:</p> <ul style="list-style-type: none"> <li>• Long Beach Peninsula -- lands west of SR 103</li> <li>• Grayland-Westport -- lands west of SR 105</li> <li>• Ocean Shores-Copalis – lands west of SR 115 and SR 109</li> </ul> <p>SC 6.1 Is the wetland one acre or larger, or is it in a mosaic of wetlands that is one acre or larger?</p> <p>YES = Category II                      NO = go to SC 6.2</p> <p>SC 6.2 Is the wetland between 0.1 and 1 acre, or is it in a mosaic of wetlands that is between 0.1 and 1 acre?</p> <p>YES = Category III</p>	<p><b>Cat. II</b></p> <p><b>Cat. III</b></p>
<p>◆</p>	<p><b>Category of wetland based on Special Characteristics</b>                  Choose the "highest" rating if wetland falls into several categories, and record on p. 1.                  If you answered NO for all types enter "Not Applicable" on p. 1</p>	<p><b>NA</b></p>

Comments:



Wetland name or number 23A

**WETLAND RATING FORM – WESTERN WASHINGTON**  
Version 2 – Updated July 2006 to increase accuracy and reproducibility among users  
Updated Oct. 2008 with the new WDFW definitions for priority habitats

Name of wetland (if known): 23A Date of site visit: 10-25-13

Rated by: Colin Worsley / Matt Maynard Trained by Ecology? Yes X No      Date of training: 11-2005 / 04-2006

SEC: 06 TOWNSHIP: 24N RANGE: 06E Is S/T/R in Appendix D? Yes      No X

Map of wetland unit: Figure      Estimated size 0.03 acre

**SUMMARY OF RATING**

Category based on FUNCTIONS provided by wetland: I      II      III      IV X

Category I =	Score > 70
Category II =	Score 51 - 69
Category III =	Score 30 – 50
Category IV =	Score < 30

Score for Water Quality Functions	14
Score for Hydrologic Functions	7
Score for Habitat Functions	7
<b>TOTAL Score for Functions</b>	<b>28</b>

Category based on SPECIAL CHARACTERISTICS of Wetland I      II      Does not apply X

**Final Category** (choose the “highest” category from above”) IV

**Summary of basic information about the wetland unit.**

Wetland Unit has Special Characteristics		Wetland HGM Class used for Rating	
<b>Estuarine</b>		<b>Depressional</b>	X
<b>Natural Heritage Wetland</b>		<b>Riverine</b>	
<b>Bog</b>		<b>Lake-fringe</b>	
<b>Mature Forest</b>		<b>Slope</b>	(x)
<b>Old Growth Forest</b>		<b>Flats</b>	
<b>Coastal Lagoon</b>		<b>Freshwater Tidal</b>	
<b>Interdunal</b>			
None of the above	X	Check if unit has multiple HGM classes present	X

**Does the wetland being rated meet any of the criteria below?** If you answer YES to any of the questions below you will need to protect the wetland according to the regulations regarding the special characteristics found in the wetland.

Check List for Wetlands that Need Additional Protection (in addition to the protection recommended for its category)	YES	NO
SP1. <i>Has the wetland unit been documented as a habitat for any Federally listed Threatened or Endangered <b>animal or plant</b> species (T/E species)?</i> For the purposes of this rating system, “documented” means the wetland is on the appropriate state or federal database.		X
SP2. <i>Has the wetland unit been documented as habitat for any State listed Threatened or Endangered <b>animal</b> species?</i> For the purposes of this rating system, “documented” means the wetland is on the appropriate state database. Note: Wetlands with State listed plant species are categorized as Category 1 Natural Heritage Wetlands (see p. 19 of data form).		X
SP3. <i>Does the wetland unit contain individuals of Priority species listed by the WDFW for the state?</i>		X
SP4. <i>Does the wetland unit have a local significance in addition to its functions?</i> For example, the wetland has been identified in the Shoreline Master Program, the Critical Areas Ordinance, or in a local management plan as having special significance.		X

To complete the next part of the data sheet you will need to determine the Hydrogeomorphic Class of the wetland being rated.

Exhibit 16  
SSDP2016-00415  
001004

### Classification of Vegetated Wetlands for Western Washington

If the hydrologic criteria listed in each question do not apply to the entire unit being rated, you probably have a unit with multiple HGM classes. In this case, identify which hydrologic criteria in questions 1-7 apply, and go to Question 8.

1. Are the water levels in the entire unit usually controlled by tides (i.e. except during floods)?  
NO – go to 2                      **YES – the wetland class is Tidal Fringe**  
 If yes, is the salinity of the water during periods of annual low flow below 0.5 ppt (parts per thousand)?  
**YES – Freshwater Tidal Fringe**                      **NO – Saltwater Tidal Fringe (Estuarine)**  
*If your wetland can be classified as a Freshwater Tidal Fringe use the forms for Riverine wetlands. If it is a Saltwater Tidal Fringe it is rated as an Estuarine wetland. Wetlands that were call estuarine in the first and second editions of the rating system are called Salt Water Tidal Fringe in the Hydrogeomorphic Classification. Estuarine wetlands were categorized separately in the earlier editions, and this separation is being kept in this revision. To maintain consistency between editions, the term “Estuarine” wetland is kept. Please note, however, that the characteristics that define Category I and II estuarine wetlands have changed (see p. \_\_\_\_\_).*

---

2. The entire wetland unit is flat and precipitation is only source (>90%) of water to it. Groundwater and surface water runoff are NOT sources of water to the unit.  
NO – go to 3                      **YES – The wetland class is Flats**  
 If your wetland can be classified as a “Flats” wetland, use the form for **Depressional** wetlands.

---

3. Does the entire wetland meet both of the following criteria?  
 \_\_\_\_\_ The vegetated part of the wetland is on the shores of a body of permanent open water (without any vegetation on the surface) where at least 20 acres (8ha) in size;  
 \_\_\_\_\_ At least 30% of the open water area is deeper than 6.6 (2 m)?  
NO – go to 4                      **YES – The wetland class is Lake-fringe (Lacustrine Fringe)**

---

4. Does the entire wetland meet all of the following criteria?  
 \_\_\_\_\_ The wetland is on a slope (*slope can be very gradual*).  
 \_\_\_\_\_ The water flows through the wetland in one direction (unidirectional) and usually comes from seeps. It may flow subsurface, as sheetflow, or in a swale without distinct banks.  
 \_\_\_\_\_ The water leaves the wetland **without being impounded**?  
 NOTE: *Surface water does not pond in these types of wetlands except occasionally in very small and shallow depressions or behind hummocks (depressions are usually <3 ft diameter and less than 1 foot deep).*  
NO – go to 5                      **YES – The wetland class is Slope**

---

5. Does the entire wetland meet all of the following criteria?  
 \_\_\_\_\_ The unit is in a valley or stream channel where it gets inundated by overbank flooding from that stream or river.  
 \_\_\_\_\_ The overbank flooding occurs at least once every two years.  
 NOTE: *The riverine unit can contain depressions that are filled with water when the river is not flooding..*  
NO – go to 6                      **YES – The wetland class is Riverine**

---

6. Is the entire wetland unit in a topographic depression in which water ponds, or is saturated to the surface, at some time of the year. This means that any outlet, if present is higher than the interior of the wetland.  
NO – go to 7                      **YES – The wetland class is Depressional**

---

7. Is the entire wetland located in a very flat area with no obvious depression and no overbank flooding. The unit does not pond surface water more than a few inches. The unit seems to be maintained by high groundwater in the area. The wetland may be ditched, but has no obvious natural outlet.  
No – go to 8                      **YES – The wetland class is Depressional**

---

8. Your wetland unit seems to be difficult to classify and probably contains several different HGM classes. For example, seeps at the base of a slope may grade into a riverine floodplain, or a small stream within a depressional wetland has a zone of flooding along its sides. **GO BACK AND IDENTIFY WHICH OF THE HYDROLOGIC REGIMES DESCRIBED IN QUESTIONS 1-7 APPLY TO DIFFERENT AREAS IN THE UNIT** (make a rough sketch to help you decide). Use the following table to identify the appropriate class to use for the rating system if you have several HGM classes present within your wetland. NOTE: Use this table only if the class that is recommended in the second column represents 10% or more of the total area of the wetland unit being rated. If the area of the class listed in column 2 is less than 10% of the unit, classify the wetland using the class that represents more than 90% of the total area.

HGM Classes within the wetland unit being rated	HGM Class to Use in Rating
Slope + Riverine	Riverine
Slope + Depressional	Depressional
Slope + Lake-fringe	Lake-fringe
Depressional + Riverine along stream within boundary	Depressional
Depressional + Lake-fringe	Depressional
Salt Water Tidal Fringe and any other class of freshwater wetland	Treat as ESTUARINE under wetlands with special characteristics

**Exhibit 16**  
**SSDP2016-00415**  
**001085**

If you are unable still to determine which of the above criteria apply to your wetland, or you have more than 2 HGM classes within a wetland boundary, classify the wetland as **Depressional** for the rating.

<b>D Depressional and Flat Wetlands</b>		<b>Points</b> (only 1 score per box) (see p.38)
WATER QUALITY FUNCTIONS – Indicators that wetland functions to improve water quality.		
<b>D 1</b>	<b>Does the wetland have the potential to improve water quality?</b>	
D 1.1	Characteristics of surface water flows out of the wetland: <ul style="list-style-type: none"> <li>• Unit is a depression with no surface water leaving it (no outlet)..... points = 3</li> <li>• Unit has an intermittently flowing, OR highly constricted, permanently flowing outlet ..... points = 2</li> <li>• Unit has an unconstricted, or slightly constricted, surface outlet (permanently flowing) ..... points = 1</li> <li>• Unit is a “flat” depression (Q.7 on key), or in the Flats class, with permanent surface outflow and no obvious natural outlet and/or outlet is a man-made ditch..... points = 1 <i>(If ditch is not permanently flowing treat unit as “intermittently flowing”)</i> Provide photo or drawing</li> </ul>	Figure ____  2
D 1.2	The soil 2 inches below the surface (or duff layer) is clay or organic (use NRCS definitions) YES points = 4 NO points = 0	0
D 1.3	Characteristics of persistent vegetation (emergent, shrub, and/or forest Cowardin class): <ul style="list-style-type: none"> <li>• Wetland has persistent, ungrazed vegetation &gt;= 95% of area..... points = 5</li> <li>• Wetland has persistent, ungrazed vegetation &gt;= 1/2 of area..... points = 3</li> <li>• Wetland has persistent, ungrazed vegetation &gt;= 1/10 of area..... points = 1</li> <li>• Wetland has persistent, ungrazed vegetation &lt; 1/10 of area..... points = 0</li> </ul> Map of Cowardin vegetation classes	Figure ____  5
D 1.4	Characteristics of seasonal ponding or inundation: <i>This is the area of the wetland that is ponded for at least 2 months, but dries out sometime during the year. Do not count the area that is permanently ponded. Estimate area as the average condition 5 out of 10 years.</i> <ul style="list-style-type: none"> <li>• Area seasonally ponded is &gt; 1/2 total area of wetland ..... points = 4</li> <li>• Area seasonally ponded is &gt; 1/4 total area of wetland ..... points = 2</li> <li>• Area seasonally ponded is &lt; 1/4 total area of wetland ..... points = 0</li> </ul> Map of Hydroperiods	Figure ____  0
<b>Total for D 1</b>		<i>Add the points in the boxes above</i>
<b>D 2 Does the wetland have the opportunity to improve water quality?</b>		(see p. 44)
Answer YES if you know or believe there are pollutants in groundwater or surface water coming into the wetland that would otherwise reduce water quality in streams, lakes or groundwater downgradient from the wetland? <i>Note which of the following conditions provide the sources of pollutants. A unit may have pollutants coming from several sources, but any single source would qualify as opportunity.</i> <input type="checkbox"/> Grazing in the wetland or within 150 ft <input type="checkbox"/> Untreated stormwater discharges to wetland <input type="checkbox"/> Tilled fields or orchards within 150 ft. of wetland <input type="checkbox"/> A stream or culvert discharges into wetland that drains developed areas, residential areas, farmed fields, roads, or clear-cut logging <input checked="" type="checkbox"/> Residential, urban areas, golf courses are within 150 ft. of wetland <input type="checkbox"/> Wetland is fed by groundwater high in phosphorus or nitrogen <input type="checkbox"/> Other _____ YES multiplier is 2                      NO multiplier is 1		Multiplier  <u> X2 </u>
<b>♦ TOTAL – Water Quality Functions</b>		14
HYDROLOGIC FUNCTIONS – Indicators that wetland unit functions to reduce flooding and stream degradation.		
<b>D 3</b>	<b>Does the wetland have the potential to reduce flooding and erosion?</b>	(see p.46)
D 3.1	Characteristics of surface water flows out of the wetland unit <ul style="list-style-type: none"> <li>• Unit is a depression with no surface water leaving it (no outlet)..... points = 4</li> <li>• Unit has an intermittently flowing, OR highly constricted permanently flowing outlet ..... points = 2</li> <li>• Unit is a “flat” depression (Q.7 on key) or in the Flats class, with permanent surface outflow and no obvious natural outlet and/or outlet is a man-made ditch..... points = 1 <i>(If ditch is not permanently flowing treat unit as “intermittently flowing”)</i></li> <li>• Unit has an unconstricted, or slightly constricted, surface outlet (permanently flowing) ..... points = 0</li> </ul>	2
D 3.2	Depth of storage during wet periods. <i>Estimate the height of ponding above the bottom of the outlet. For units with no outlet measure from the surface of permanent water or deepest part (if dry).</i> <ul style="list-style-type: none"> <li>• Marks of ponding are 3 ft. or more above the surface or bottom of the outlet ..... points = 7</li> <li>• The wetland is a “headwater” wetland..... points = 5</li> <li>• Marks of ponding between 2 ft. to &lt; 3 ft. from surface or bottom of outlet ..... points = 5</li> <li>• Marks are at least 0.5 ft. to &lt; 2 ft. from surface or bottom of outlet..... points = 3</li> <li>• Wetland is flat (yes to Q.2 or Q.7 on key)but has small depressions on the surface that trap water points = 1</li> <li>• Marks of ponding less than 0.5 ft ..... points = 0</li> </ul>	0
D 3.3	Contribution of wetland unit to storage in the watershed: <i>Estimate the ratio of the area of upstream basin contributing surface water to the wetland to the area of the wetland unit itself.</i> <ul style="list-style-type: none"> <li>• The area of the basin is less than 10 times the area of unit..... points = 5</li> <li>• The area of the basin is 10 to 100 times the area of the unit ..... points = 3</li> <li>• The area of the basin is more than 100 times the area of the unit ..... points = 0</li> <li>• Entire unit is in the FLATS class ..... points = 5</li> </ul>	5
<b>Total for D 3</b>		<i>Add the points in the boxes above</i>

<b>D 4</b>	<p><b>Does the wetland have the <u>opportunity</u> to reduce flooding and erosion?</b></p> <p>Answer YES if the unit is in a location in the watershed where the flood storage, or reduction in water velocity, it provides helps protect downstream property and aquatic resources from flooding or excessive and/or erosive flows. Answer NO if the water coming into the wetland is controlled by a structure such as flood gate, tide gate, flap valve, reservoir etc. OR you estimate that more than 90% of the water in the wetland is from groundwater in areas where damaging groundwater flooding does not occur. <i>Note which of the following indicators of opportunity apply.</i></p> <p><input type="checkbox"/> Wetland is in a headwater of a river or stream that has flooding problems.</p> <p><input type="checkbox"/> Wetland drains to a river or stream that has flooding problems</p> <p><input type="checkbox"/> Wetland has no outlet and impounds surface runoff water that might otherwise flow into a river or stream that has flooding problems</p> <p><input type="checkbox"/> Other _____</p> <p>YES multiplier is 2      NO multiplier is 1</p>	<p>(see p. 49)</p> <p>Multiplier</p> <p>X1</p>
◆	<p><b>TOTAL – Hydrologic Functions</b>      Multiply the score from D3 by D4; then <i>add score to table on p. 1</i></p>	<p>7</p>

Comments:





<p><i>These questions apply to wetlands of all HGM classes.</i></p> <p>HABITAT FUNCTIONS – Indicators that wetland functions to provide important habitat.</p>		<p><b>Points</b> (only 1 score per box)</p>
<p><b>H 1 Does the wetland have the potential to provide habitat for many species?</b></p>		
<p>H 1.1 <u>Vegetation structure</u> (see P. 72):                      Check the types of vegetation classes present (as defined by Cowardin) – Size threshold for each class is 1/4 acre or more than 10% of the area if unit is smaller than 2.5 acres.  <input type="checkbox"/> Aquatic Bed  <input checked="" type="checkbox"/> Emergent plants  <input type="checkbox"/> Scrub/shrub (areas where shrubs have &gt; 30% cover)  <input type="checkbox"/> Forested (areas where trees have &gt; 30% cover)                      If the unit has a forested class check if:  <input type="checkbox"/> The forested class has 3 out of 5 strata (canopy, sub-canopy, shrubs, herbaceous, moss/ground-cover) that each cover 20% within the forested polygon.                      Add the number of vegetation types that qualify. If you have:                      4 structures or more..... points = 4                      3 structures..... points = 2                      2 structures..... points = 1</p>	<p><b>Figure</b> ____</p> <p>0</p>	<p><b>Map of Cowardin vegetation classes</b>                      3 structures..... points = 2                      1 structure..... points = 0</p>
<p>H 1.2 <u>Hydroperiods</u> (see p.73):                      Check the types of water regimes (hydroperiods) present within the wetland. The water regime has to cover more than 10% of the wetland or 1/4 acre to count (see text for descriptions of hydroperiods).  <input checked="" type="checkbox"/> Permanently flooded or inundated  <input type="checkbox"/> Seasonally flooded or inundated  <input type="checkbox"/> Occasionally flooded or inundated  <input checked="" type="checkbox"/> Saturated only  <input type="checkbox"/> Permanently flowing stream or river in, or adjacent to, the wetland  <input type="checkbox"/> Seasonally flowing stream in, or adjacent to, the wetland  <input type="checkbox"/> <b>Lake-fringe wetland..... = 2 points</b>  <input type="checkbox"/> <b>Freshwater tidal wetland..... = 2 points</b></p>	<p><b>Figure</b> ____</p> <p>1</p>	<p><b>Map of hydroperiods</b>                      4 or more types present points = 3                      3 or more types present..... points = 2                      2 types present..... points = 1                      1 type present ..... points = 0</p>
<p>H 1.3 <u>Richness of Plant Species</u> (see p. 75):                      Count the number of plant species in the wetland that cover at least 10 ft<sup>2</sup> (different patches of the same species can be combined to meet the size threshold)                      You do not have to name the species. Do not include Eurasian Milfoil, reed canarygrass, purple loosestrife, Canadian Thistle.                      If you counted: &gt; 19 species ..... points = 2                      5 – 19 species..... points = 1                      &lt; 5 species ..... points = 0                      List species below if you want to:                      _____                      _____                      _____</p>	<p><b>Figure</b> ____</p> <p>1</p>	
<p>H 1.4 <u>Interspersion of Habitats</u> (see p. 76):                      Decided from the diagrams below whether interspersion between Cowardin vegetation (described in H1.1), or the classes and unvegetated areas (can include open water or mudflats) is high, medium, low, or none.</p> <div style="display: flex; justify-content: space-around;"> <div style="text-align: center;">  <p>None = 0 points</p> </div> <div style="text-align: center;">  <p>Low = 1 point</p> </div> <div style="text-align: center;">  <p>Moderate = 2 points</p> </div> </div> <div style="display: flex; justify-content: space-around; margin-top: 20px;"> <div style="text-align: center;">  <p>High = 3 points</p> </div> <div style="text-align: center;">  <p>High = 3 points</p> </div> <div style="text-align: center;">  <p>[riparian braided channels]</p> </div> </div> <p>Note: If you have 4 or more classes or 3 vegetation classes and open water, the rating is always “high”.                      Use map of Cowardin classes.</p>	<p><b>Figure</b> ____</p> <p>0</p>	
<p>H 1.5 <u>Special Habitat Features</u> (see p. 77):                      Check the habitat features that are present in the wetland. The number of checks is the number of points you put into the next column.  <input type="checkbox"/> Large, downed, woody debris within the wetland (&gt; 4 in. diameter and 6 ft. long)  <input type="checkbox"/> Standing snags (diameter at the bottom &gt; 4 inches) in the wetland  <input type="checkbox"/> Undercut banks are present for at least 6.6 ft. (2m) and/or overhanging vegetation extends at least 3.3 ft. (1m) over a stream (or ditch) in, or contiguous with the unit, for at least 33 ft. (10m)  <input type="checkbox"/> Stable steep banks of fine material that might be used by beaver or muskrat for denning (&gt; 30 degree slope) OR signs of recent beaver activity are present (cut shrubs or trees that have not yet turned grey/brown)  <input type="checkbox"/> At least 1/4 acre of thin-stemmed persistent vegetation or woody branches are present in areas that are permanently or seasonally inundated (structures for egg-laying by amphibians)  <input type="checkbox"/> Invasive plants cover less than 25% of the wetland area in each stratum of plants                      NOTE: The 20% stated in early printings of the manual on page 78 is an error.</p>	<p><b>Figure</b> ____</p> <p>0</p>	
<p><b>H 1 TOTAL Score</b> – potential for providing habitat</p>		<p>Add the points in the column</p> <p><b>2</b></p>

Exhibit 16  
SSDP2016-00415  
001088

<b>H 2</b>	<b>Does the wetland have the <u>opportunity</u> to provide habitat for many species?</b>	(only 1 score per box)
	<p>H 2.1 <b>Buffers</b> (see P. 80):  <i>Choose the description that best represents condition of buffer of wetland unit. The highest scoring criterion that applies to the wetland is to be used in the rating. See text for definition of "undisturbed".</i></p> <p><input type="checkbox"/> 100m (330 ft) of relatively undisturbed vegetated areas, rocky areas, or open water &gt; 95% of circumference. No structures are within the undisturbed part of buffer (relatively undisturbed also means no grazing, no landscaping, no daily human use)..... <b>points = 5</b></p> <p><input type="checkbox"/> 100m (330 ft) of relatively undisturbed vegetated areas, rocky areas, or open water &gt; 50% circumference ..... <b>points = 4</b></p> <p><input type="checkbox"/> 50m (170 ft) of relatively undisturbed vegetated areas, rocky areas, or open water &gt; 95% circumference ..... <b>points = 4</b></p> <p><input type="checkbox"/> 100m (330 ft) of relatively undisturbed vegetated areas, rocky areas, or open water &gt; 25% circumference ..... <b>points = 3</b></p> <p><input type="checkbox"/> 50m (170 ft) of relatively undisturbed vegetated areas, rocky areas, or open water for &gt; 50% circumference ..... <b>points = 3</b></p> <p><b>If buffer does not meet any of the criteria above:</b></p> <p><input type="checkbox"/> No paved areas (except paved trails) or buildings within 25m (80 ft) of wetland &gt; 95% circumference. Light to moderate grazing or lawns are OK ..... <b>points = 2</b></p> <p><input type="checkbox"/> No paved areas of buildings within 50m of wetland for &gt; 50% circumference. Light to moderate grazing or lawns are OK..... <b>points = 2</b></p> <p><input type="checkbox"/> Heavy grazing in buffer ..... <b>points = 1</b></p> <p><input type="checkbox"/> Vegetated buffers are &lt; 2m wide (6.6 ft) for more than 95% circumference (e.g. tilled fields, paving, basalt bedrock extend to edge of wetland) ..... <b>points = 0</b></p> <p><input checked="" type="checkbox"/> Buffer does not meet any of the criteria above ..... <b>points = 1</b></p> <p style="text-align: right;"><b>Arial photo showing buffers</b></p>	<p><b>Figure</b> _____</p> <p style="text-align: center;">1</p>
	<p>H 2.2 <b>Corridors and Connections</b> (see p. 81)</p> <p>H 2.2.1 Is the wetland part of a relatively undisturbed and unbroken vegetated corridor (either riparian or upland) that is at least 150 ft. wide, has at least a 30% cover of shrubs, forest or native undisturbed prairie, that connects to estuaries, other wetlands or undisturbed uplands that are at least 250 acres in size? (<i>Dams in riparian corridors, heavily used gravel roads, paved roads, are considered breaks in the corridor.</i>)                      YES = <b>4 points</b> (go to H 2.3) <span style="background-color: yellow;">NO = go to H 2.2.2</span></p> <p>H. 2.2.2 Is the wetland part of a relatively undisturbed and unbroken vegetated corridor (either riparian or upland) that is at least 50 ft. wide, has at least 30% cover of shrubs or forest, and connects to estuaries, other wetlands or undisturbed uplands that are at least 25 acres in size? <b>OR a Lake-fringe</b> wetland, if it does not have an undisturbed corridor as in the question above?                      YES = <b>2 points</b> (go to H 2.3) <span style="background-color: yellow;">NO = go to H 2.2.3</span></p> <p>H. 2.2.3 Is the wetland:</p> <ul style="list-style-type: none"> <li>• Within 5 mi (8km) of a brackish or salt water estuary OR</li> <li>• Within 3 miles of a large field or pasture (&gt; 40 acres) OR <span style="background-color: yellow;">YES = 1 point</span></li> <li>• <span style="background-color: yellow;">Within 1 mile of a lake greater than 20 acres?</span> <span style="background-color: yellow;">NO = 0 points</span></li> </ul>	<p style="text-align: center;">1</p>

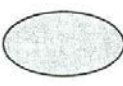
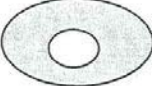
**Comments:**

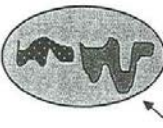
	<p>H 2.3 <u>Near or adjacent to other priority habitats listed by WDFW</u> (see p. 82): (see new and complete descriptions of WDFW priority habitats, and the counties in which they can be found, in the PHS report <a href="http://wdfw.wa.gov/hab/phslist.htm">http://wdfw.wa.gov/hab/phslist.htm</a> )</p> <p>Which of the following priority habitats are within 330 ft. (100m) of the wetland unit?  <i>NOTE: the connections do not have to be relatively undisturbed.</i></p> <p><input type="checkbox"/> <b>Aspen Stands:</b> Pure or mixed stands of aspen greater than 0.4 ha (1 acre).</p> <p><input type="checkbox"/> <b>Biodiversity Areas and Corridors:</b> Areas of habitat that are relatively important to various species of native fish and wildlife (full descriptions in WDFW PHS report p. 152).</p> <p><input type="checkbox"/> <b>Herbaceous Balds:</b> Variable size patches of grass and forbs on shallow soils over bedrock.</p> <p><input type="checkbox"/> <b>Old-growth/Mature forests:</b> (Old-growth west of Cascade crest) Stands of at least 2 tree species, forming a multi-layered canopy with occasional small openings; with at least 20 trees/ha (8 trees/acre) &gt; 81 cm (32 in) dbh or &gt; 200 years of age. (Mature forests) Stands with average diameters exceeding 53 cm (21 in) dbh; crown cover may be less than 100%; decay, decadence, numbers of snags, and quantity of large downed material is generally less than that found in old-growth; 80 - 200 years old west of the Cascade crest.</p> <p><input type="checkbox"/> <b>Oregon white Oak:</b> Woodlands Stands of pure oak or oak/conifer associations where canopy coverage of the oak component is important (full descriptions in WDFW PHS report p. 158).</p> <p><input type="checkbox"/> <b>Riparian:</b> The area adjacent to aquatic systems with flowing water that contains elements of both aquatic and terrestrial ecosystems which mutually influence each other.</p> <p><input type="checkbox"/> <b>Westside Prairies:</b> Herbaceous, non-forested plant communities that can either take the form of a dry prairie or a wet prairie (full descriptions in WDFW PHS report p. 161).</p> <p><input type="checkbox"/> <b>Instream:</b> The combination of physical, biological, and chemical processes and conditions that interact to provide functional life history requirements for instream fish and wildlife resources.</p> <p><input type="checkbox"/> <b>Nearshore:</b> Relatively undisturbed nearshore habitats. These include Coastal Nearshore, Open Coast Nearshore, and Puget Sound Nearshore. (full descriptions of habitats and the definition of relatively undisturbed are in WDFW report: pp. 167-169 and glossary in Appendix A).</p> <p><input type="checkbox"/> <b>Caves:</b> A naturally occurring cavity, recess, void, or system of interconnected passages under the earth in soils, rock, ice, or other geological formations and is large enough to contain a human.</p> <p><input type="checkbox"/> <b>Cliffs:</b> Greater than 7.6 m (25 ft) high and occurring below 5000 ft.</p> <p><input type="checkbox"/> <b>Talus:</b> Homogenous areas of rock rubble ranging in average size 0.15 - 2.0 m (0.5 - 6.5 ft), composed of basalt, andesite, and/or sedimentary rock, including riprap slides and mine tailings. May be associated with cliffs.</p> <p><input type="checkbox"/> <b>Snags and Logs:</b> Trees are considered snags if they are dead or dying and exhibit sufficient decay characteristics to enable cavity excavation/use by wildlife. Priority snags have a diameter at breast height of &gt; 51 cm (20 in) in western Washington and are &gt; 2 m (6.5 ft) in height. Priority logs are &gt; 30 cm (12 in) in diameter at the largest end, and &gt; 6 m (20 ft) long.</p> <p>If wetland has <b>3 or more</b> priority habitats = <b>4 points</b>                  If wetland has <b>2</b> priority habitats = <b>3 points</b>                  If wetland has <b>1</b> priority habitat = <b>1 point</b>                      <b>No habitats = 0 points</b></p> <p>Note: All vegetated wetlands are by definition a priority habitat but are not included in this list. Nearby wetlands are addressed in question H 2.4)</p>	0
	<p>H 2.4 <u>Wetland Landscape:</u> Choose the <b>one</b> description of the landscape around the wetland that best fits (see p. 84)</p> <ul style="list-style-type: none"> <li>• There are at least 3 other wetlands within 1/2 mile, and the connections between them are relatively undisturbed (light grazing between wetlands OK, as is lake shore with some boating, but connections should NOT be bisected by paved roads, fill, fields, or other development.....points = 5</li> <li>• The wetland is Lake-fringe on a lake with little disturbance and there are 3 other lake-fringe wetlands within 1/2 mile .....points = 5</li> <li>• <b>There are at least 3 other wetlands within 1/2 mile, BUT the connections between them are disturbed.....points = 3</b></li> <li>• The wetland fringe on a lake <b>with</b> disturbance and there are 3 other lake-fringe wetlands within 1/2 mile .....points = 3</li> <li>• There is at least 1 wetland within 1/2 mile .....points = 2</li> <li>• There are no wetlands within 1/2 mile.....points = 0</li> </ul>	3
	<p><b>H 2 TOTAL Score</b> – opportunity for providing habitat                      Add the scores from H2.1, H2.2, H2.3, H2.4</p>	5
	<p style="text-align: right;">TOTAL for H 1 from page 8</p>	2
◆	<p><b>Total Score for Habitat Functions</b>                      Add the points for H 1 and H 2; then <b>record the result on p. 1</b></p>	7

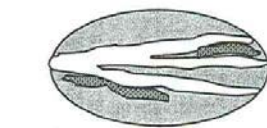
Comments:

## CATEGORIZATION BASED ON SPECIAL CHARACTERISTICS

*Please determine if the wetland meets the attributes described below and circle the appropriate answers and Category.*

<b>Wetland Type</b> – Check off any criteria that apply to the wetland. Circle the Category when the appropriate criteria are met.	
<b>SC1</b>	<p><b>Estuarine wetlands?</b> (see p.86)</p> <p>Does the wetland unit meet the following criteria for Estuarine wetlands?</p> <p><input type="checkbox"/> The dominant water regime is tidal,</p> <p><input type="checkbox"/> Vegetated, and</p> <p><input type="checkbox"/> With a salinity greater than 0.5 ppt.</p> <p>YES = Go to SC 1.1                      NO <u>  X  </u></p>
	<p>SC 1.1 Is the wetland unit within a National Wildlife Refuge, National Park, National Estuary Reserve, Natural Area Preserve, State Park or Educational, Environmental, or Scientific Reserve designated under WAC 332-30-151?    YES = Category I                      NO = go to SC 1.2</p>
	<p>SC 1.2 Is the wetland at least 1 acre in size and meets at least two of the following conditions?</p> <p>YES = Category I                      NO = Category II</p> <p><input type="checkbox"/> The wetland is relatively undisturbed (has no diking, ditching, filling, cultivation, grazing, and has less than 10% cover of non-native plant species. If the non-native <i>Spartina</i> spp., are only species that cover more than 10% of the wetland, then the wetland should be given a dual rating (I/II). The area of <i>Spartina</i> would be rated a Category II while the relatively undisturbed upper marsh with native species would be a Category I. Do not, however, exclude the area of <i>Spartina</i> in determining the size threshold of 1 acre.</p> <p><input type="checkbox"/> At least 3/4 of the landward edge of the wetland has a 100 ft. buffer of shrub, forest, or un-grazed or un-mowed grassland</p> <p><input type="checkbox"/> The wetland has at least 2 of the following features: tidal channels, depressions with open water, or contiguous freshwater wetlands.</p>
	<p><b>Cat. I</b></p> <p><b>Cat. II</b></p> <p><b>Dual Rating I/II</b></p>
<b>SC2</b>	<p><b>Natural Heritage Wetlands</b> (see p. 87)</p> <p>Natural Heritage wetlands have been identified by the Washington Natural Heritage Program/DNR as either high quality undisturbed wetlands or wetlands that support state Threatened, Endangered, or Sensitive plant species.</p> <p>SC 2.1 Is the wetland being rated in a Section/Township/Range that contains a natural heritage wetland? (<i>This question is used to screen out most sites before you need to contact WNHP/DNR.</i>)</p> <p>S/T/R information from Appendix D _____ or accessed from WNHP/DNR web site _____</p> <p>YES _____ Contact WNHP/DNR (see p. 79) and go to SC 2.2                      NO <u>  X  </u></p> <p>SC 2.2 Has DNR identified the wetland as a high quality undisturbed wetland or as a site with state threatened or endangered plant species?</p> <p>YES = Category 1                      NO _____ not a Heritage Wetland</p>
	<p><b>Cat I</b></p>
<b>SC3</b>	<p><b>Bogs</b> (see p. 87)</p> <p>Does the wetland (<b>or any part of the unit</b>) meet both the criteria for soils and vegetation in bogs? Use the key below to identify if the wetland is a bog. <b><i>If you answer yes you will still need to rate the wetland based on its function.</i></b></p> <p>1. Does the unit have organic soil horizons (i.e. layers of organic soil), either peats or mucks, that compose 16 inches or more of the first 32 inches of soil profile? (See Appendix B for a field key to identify organic soils)?    YES = go to question 3                      <b>NO = go to question 2</b></p> <p>2. Does the wetland have organic soils, either peats or mucks that are less than 16 inches deep over bedrock, or an impermeable hardpan such as clay or volcanic ash, or that are floating on a lake or pond?    YES = go to question 3                      <b>NO = is not a bog for purpose of rating</b></p> <p>3. Does the unit have more than 70% cover of mosses at ground level, AND other plants, if present, consist of the “bog” species listed in Table 3 as a significant component of the vegetation (more than 30% of the total shrub and herbaceous cover consists of species in Table 3)?</p> <p>YES = Is a bog for purpose of rating                      NO = go to question 4</p> <p>NOTE: If you are uncertain about the extent of mosses in the understory you may substitute that criterion by measuring the pH of the water that seeps into a hole dug at least 16” deep. If the pH is less than 5.0 and the “bog” plant species in Table 3 are present, the wetland is a bog.</p> <p>4. Is the unit forested (&gt; 30% cover) with sitka spruce, subalpine fir, western red cedar, western hemlock, lodgepole pine, quaking aspen, Englemann’s spruce, or western white pine. WITH any of the species (or combination of species) on the bog species plant list in Table 3 as a significant component of the ground cover (&gt; 30% coverage of the total shrub/herbaceous cover)?</p> <p>YES = Category I                      NO = Is not a bog for purpose of rating</p>
	<p><b>Cat. I</b></p>

**Exhibit 16**  
**SSDP2016-00415**  
**001091**



<p><b>SC4</b></p>	<p><b>Forested Wetlands</b> (<i>see p. 90</i>)</p> <p>Does the wetland have at least 1 acre of forest that meet one of these criteria for the Department of Fish and Wildlife's forests as priority habitats? <i>If you answer yes you will still need to rate the wetland based on its function.</i></p> <p>___ <b>Old-growth forests:</b> (west of Cascade Crest) Stands of at least two three species forming a multi-layered canopy with occasional small openings; with at least 8 trees/acre (20 trees/hectare) that are at least 200 years of age OR have a diameter at breast height (dbh) of 32 inches (81 cm or more).</p> <p>NOTE: The criterion for dbh is based on measurements for upland forests. Two-hundred year old trees in wetlands will often have a smaller dbh because their growth rates are often slower. The DFW criterion is and "OR" so old-growth forests do not necessarily have to have trees of this diameter.</p> <p>___ <b>Mature forests:</b> (west of the Cascade Crest) Stands where the largest trees are 80 – 200 years old OR have an average diameters (dbh) exceeding 21 inches (53 cm); crown cover may be less than 100%; decay, decadence, numbers of snags, and quantity of large downed material is generally less than that found in old-growth.</p> <p>YES = Category I                      NO = <u>X</u> not a forested wetland with special characteristics</p>	<p><b>Cat. I</b></p>
<p><b>SC5</b></p>	<p><b>Wetlands in Coastal Lagoons</b> (<i>see p. 91</i>)</p> <p>Does the wetland meet all of the following criteria of a wetland in a coastal lagoon?</p> <p>___ The wetland lies in a depression adjacent to marine waters that is wholly or partially separated from marine waters by sandbanks, gravel banks, shingle, or, less frequently, rocks.</p> <p>___ The lagoon in which the wetland is located contains surface water that is saline or brackish (&gt; 0.5 ppt) during most of the year in at least a portion of the lagoon (<i>needs to be measured near the bottom.</i>)</p> <p>YES = Go to SC 5.1                      NO <u>X</u> not a wetland in a coastal lagoon</p> <p>SC 5.1 Does the wetland meet all of the following three conditions?</p> <p>___ The wetland is relatively undisturbed (has no diking, ditching, filling, cultivation, grazing) and has less than 20% cover of invasive plant species (see list of invasive species on p. 74).</p> <p>___ At least 3/4 of the landward edge of the wetland has a 100 ft. buffer of shrub, forest, or un-grazed or un-mowed grassland.</p> <p>___ The wetland is larger than 1/10 acre (4350 square ft.)</p> <p>YES = Category I                      NO = Category II</p>	<p><b>Cat. I</b></p> <p><b>Cat. II</b></p>
<p><b>SC6</b></p>	<p><b>Interdunal Wetlands</b> (<i>see p. 93</i>)</p> <p>Is the wetland west of the 1889 line (also called the Western Boundary of Upland Ownership or WBUO)?</p> <p>YES = Go to SC 6.1                      NO <u>X</u> not an interdunal wetland for rating</p> <p><b><i>If you answer yes you will still need to rate the wetland based on its functions.</i></b></p> <p>In practical terms that means the following geographic areas:</p> <ul style="list-style-type: none"> <li>• Long Beach Peninsula -- lands west of SR 103</li> <li>• Grayland-Westport -- lands west of SR 105</li> <li>• Ocean Shores-Copalis – lands west of SR 115 and SR 109</li> </ul> <p>SC 6.1 Is the wetland one acre or larger, or is it in a mosaic of wetlands that is one acre or larger?</p> <p>YES = Category II                      NO = go to SC 6.2</p> <p>SC 6.2 Is the wetland between 0.1 and 1 acre, or is it in a mosaic of wetlands that is between 0.1 and 1 acre?</p> <p>YES = Category III</p>	<p><b>Cat. II</b></p> <p><b>Cat. III</b></p>
<p>◆</p>	<p><b>Category of wetland based on Special Characteristics</b></p> <p><i>Choose the "highest" rating if wetland falls into several categories, and record on p. 1.</i></p> <p>If you answered NO for all types enter "Not Applicable" on p. 1</p>	<p><b>NA</b></p>

**Comments:**

Wetland name or number 23B

**WETLAND RATING FORM – WESTERN WASHINGTON**  
Version 2 – Updated July 2006 to increase accuracy and reproducibility among users  
Updated Oct. 2008 with the new WDFW definitions for priority habitats

Name of wetland (if known): 23B Date of site visit: 09-20-13

Rated by: Colin Worsley / Matt Maynard Trained by Ecology? Yes  No  Date of training: 11-2005 / 04-2006

SEC: 06 TWNSHP: 24N RNGE: 06E Is S/T/R in Appendix D? Yes  No

Map of wetland unit: Figure \_\_\_\_\_ Estimated size 0.05 acre

**SUMMARY OF RATING**

Category based on FUNCTIONS provided by wetland: I \_\_\_\_\_ II \_\_\_\_\_ III X IV \_\_\_\_\_

Category I =	Score > 70
Category II =	Score 51 - 69
Category III =	Score 30 – 50
Category IV =	Score < 30

Score for Water Quality Functions	20
Score for Hydrologic Functions	4
Score for Habitat Functions	10
<b>TOTAL Score for Functions</b>	<b>34</b>

Category based on SPECIAL CHARACTERISTICS of Wetland I \_\_\_\_\_ II \_\_\_\_\_ Does not apply X

**Final Category** (choose the “highest” category from above”) **III**

**Summary of basic information about the wetland unit.**

Wetland Unit has Special Characteristics		Wetland HGM Class used for Rating	
<b>Estuarine</b>		<b>Depressional</b>	
<b>Natural Heritage Wetland</b>		<b>Riverine</b>	
<b>Bog</b>		<b>Lake-fringe</b>	<b>X</b>
<b>Mature Forest</b>		<b>Slope</b>	<b>(x)</b>
<b>Old Growth Forest</b>		<b>Flats</b>	
<b>Coastal Lagoon</b>		<b>Freshwater Tidal</b>	
<b>Interdunal</b>			
None of the above	<b>X</b>	Check if unit has multiple HGM classes present	<b>X</b>

**Does the wetland being rated meet any of the criteria below?** If you answer YES to any of the questions below you will need to protect the wetland according to the regulations regarding the special characteristics found in the wetland.

Check List for Wetlands that Need Additional Protection (in addition to the protection recommended for its category)	YES	NO
SP1. <i>Has the wetland unit been documented as a habitat for any Federally listed Threatened or Endangered <b>animal or plant</b> species (T/E species)?</i> For the purposes of this rating system, “documented” means the wetland is on the appropriate state or federal database.		X
SP2. <i>Has the wetland unit been documented as habitat for any State listed Threatened or Endangered <b>animal</b> species?</i> For the purposes of this rating system, “documented” means the wetland is on the appropriate state database. Note: Wetlands with State listed plant species are categorized as Category 1 Natural Heritage Wetlands (see p. 19 of data form).		X
SP3. <i>Does the wetland unit contain individuals of Priority species listed by the WDFW for the state?</i>		X
SP4. <i>Does the wetland unit have a local significance in addition to its functions?</i> For example, the wetland has been identified in the Shoreline Master Program, the Critical Areas Ordinance, or in a local management plan as having special significance.		X

To complete the next part of the data sheet you will need to determine the Hydrogeomorphic Class of the wetland being rated.

Exhibit 16  
SSDP2016-00415  
001093

The hydrogeomorphic classification groups wetlands in to those that function in similar ways. This simplifies the questions needed to answer how well the wetland functions. The Hydrogeomorphic Class of a wetland can be determined using the key below. See p. 24 for more detailed instructions on classifying wetlands.  
Wetland Rating Form – Western Washington, Version 2 (7/06), updated with new WDFW definitions Oct. 2008

### Classification of Vegetated Wetlands for Western Washington

If the hydrologic criteria listed in each question do not apply to the entire unit being rated, you probably have a unit with multiple HGM classes. In this case, identify which hydrologic criteria in questions 1-7 apply, and go to Question 8.

1. Are the water levels in the entire unit usually controlled by tides (i.e. except during floods)?  
NO – go to 2                      **YES – the wetland class is Tidal Fringe**  
 If yes, is the salinity of the water during periods of annual low flow below 0.5 ppt (parts per thousand)?  
**YES – Freshwater Tidal Fringe**                      **NO – Saltwater Tidal Fringe (Estuarine)**  
*If your wetland can be classified as a Freshwater Tidal Fringe use the forms for Riverine wetlands. If it is a Saltwater Tidal Fringe it is rated as an Estuarine wetland. Wetlands that were call estuarine in the first and second editions of the rating system are called Salt Water Tidal Fringe in the Hydrogeomorphic Classification. Estuarine wetlands were categorized separately in the earlier editions, and this separation is being kept in this revision. To maintain consistency between editions, the term “Estuarine” wetland is kept. Please note, however, that the characteristics that define Category I and II estuarine wetlands have changed (see p. \_\_\_\_).*

---

2. The entire wetland unit is flat and precipitation is only source (>90%) of water to it. Groundwater and surface water runoff are NOT sources of water to the unit.  
NO – go to 3                      **YES – The wetland class is Flats**  
 If your wetland can be classified as a “Flats” wetland, use the form for **Depressional** wetlands.

---

3. Does the entire wetland meet both of the following criteria?  
 The vegetated part of the wetland is on the shores of a body of permanent open water (without any vegetation on the surface) where at least 20 acres (8ha) in size;  
 At least 30% of the open water area is deeper than 6.6 (2 m)?  
NO – go to 4                      **YES – The wetland class is Lake-fringe (Lacustrine Fringe)**

---

4. Does the entire wetland meet all of the following criteria?  
 The wetland is on a slope (*slope can be very gradual*).  
 The water flows through the wetland in one direction (unidirectional) and usually comes from seeps. It may flow subsurface, as sheetflow, or in a swale without distinct banks.  
 The water leaves the wetland **without being impounded**?  
*NOTE: Surface water does not pond in these types of wetlands except occasionally in very small and shallow depressions or behind hummocks (depressions are usually <3 ft diameter and less than 1 foot deep).*  
NO – go to 5                      **YES – The wetland class is Slope**

---

5. Does the entire wetland meet all of the following criteria?  
 The unit is in a valley or stream channel where it gets inundated by overbank flooding from that stream or river.  
 The overbank flooding occurs at least once every two years.  
*NOTE: The riverine unit can contain depressions that are filled with water when the river is not flooding..*  
NO – go to 6                      **YES – The wetland class is Riverine**

---

6. Is the entire wetland unit in a topographic depression in which water ponds, or is saturated to the surface, at some time of the year. This means that any outlet, if present is higher than the interior of the wetland.  
NO – go to 7                      **YES – The wetland class is Depressional**

---

7. Is the entire wetland located in a very flat area with no obvious depression and no overbank flooding. The unit does not pond surface water more than a few inches. The unit seems to be maintained by high groundwater in the area. The wetland may be ditched, but has no obvious natural outlet.  
No – go to 8                      **YES – The wetland class is Depressional**

---

8. Your wetland unit seems to be difficult to classify and probably contains several different HGM classes. For example, seeps at the base of a slope may grade into a riverine floodplain, or a small stream within a depressional wetland has a zone of flooding along its sides. **GO BACK AND IDENTIFY WHICH OF THE HYDROLOGIC REGIMES DESCRIBED IN QUESTIONS 1-7 APPLY TO DIFFERENT AREAS IN THE UNIT** (make a rough sketch to help you decide). Use the following table to identify the appropriate class to use for the rating system if you have several HGM classes present within your wetland. *NOTE: Use this table only if the class that is recommended in the second column represents 10% or more of the total area of the wetland unit being rated. If the area of the class listed in column 2 is less than 10% of the unit, classify the wetland using the class that represents more than 90% of the total area.*

HGM Classes within the wetland unit being rated	HGM Class to Use in Rating
Slope + Riverine	Riverine
Slope + Depressional	Depressional
Slope + Lake-fringe	Lake-fringe
Depressional + Riverine along stream within boundary	Depressional
Depressional + Lake-fringe	Depressional
Salt Water Tidal Fringe and any other class of freshwater wetland	Treat as ESTUARINE under wetlands with special characteristics

**Exhibit 16**  
**SSDP2016-00415**  
**001094**

If you are unable still to determine which of the above criteria apply to your wetland, or you have more than 2 HGM classes within a wetland boundary, classify the wetland as **Depressional** for the rating.

<b>L Lake-fringe Wetlands</b>		<b>Points</b>
<b>WATER QUALITY FUNCTIONS – Indicators that the wetland unit functions to improve water quality.</b>		(only 1 score per box)
<b>L 1</b>	<b>Does the wetland unit have the <u>potential</u> to improve water quality? (see p.59)</b>	
L 1.1	Average width of vegetation along the lakeshore (use polygons of Cowardin classes): • Vegetation is more than 33 ft. (10m) wide ..... points = 6 • Vegetation is more than 16 ft.(5m) wide and < 33 ft ..... points = 3 • Vegetation is more than 6 ft. (2m) wide and < 16 ft ..... points = 1 • Vegetation is less than 6 ft. wide..... points = 0 <b>Map of Cowardin classes with widths marked</b>	<b>Figure</b> ____ 6
L 1.2	Characteristics of the vegetation in the wetland: <i>Choose the appropriate description that results in the highest points, and do not include any open water in your estimate of coverage. The herbaceous plants can be either the dominant form or as an understory in a shrub or forest community. These are not Cowardin classes. Area of Cover is total cover in the unit, but it can be in patches. NOTE: Herbaceous does not include aquatic bed.</i> • Cover of herbaceous plants is > 90% of the vegetated area..... points = 6 • Cover of herbaceous plants is > 2/3 of the vegetated area..... points = 4 • Cover of herbaceous plants is > 1/3 of the vegetated area..... points = 3 • Other vegetation that is not aquatic bed or herbaceous covers > 2/3 of the unit ..... points = 3 • Other vegetation that is not aquatic bed in > 1/3 vegetated area ..... points = 1 • Aquatic bed cover and open water > 2/3 of the unit..... points = 0 <b>Map with polygons of different vegetation types</b>	<b>Figure</b> ____ 4
<i>Add the points in the boxes above</i>		<b>10</b>
<b>L 2</b>	<b>Does the wetland have the <u>opportunity</u> to improve water quality?</b>	(see p.61)
Answer YES if you know or believe there are pollutants in the lake water, or polluted surface water flowing through the unit to the lake. <i>Note which of the following conditions provide the sources of pollutants. A unit may have pollutants coming from several sources, but any single source would qualify as opportunity.</i> ____ Wetland is along the shores of a lake or reservoir that does not meet water quality standards ____ Grazing in the wetland or within 150 ft ____ Polluted water discharges to wetland along upland edge ____ Tilled fields or orchards within 150 ft. of wetland <input checked="" type="checkbox"/> Residential or urban areas are within 150 ft. of wetland ____ Parks with grassy areas that are maintained, ballfields, golf courses (all within 150 ft. of lake shore) <input checked="" type="checkbox"/> Power boats with gasoline or diesel engines use the lake ____ Other _____ YES multiplier is 2 NO multiplier is 1		Multiplier X2
<b>◆</b>	<b>TOTAL – Water Quality Functions</b> Multiply the score from L1 by L2; then <i>add score to table on p. 1</i>	<b>20</b>
<b>HYDROLOGIC FUNCTIONS – Indicators that wetland functions to reduce shoreline erosion.</b>		
<b>L 3</b>	<b>Does the wetland have the <u>potential</u> to reduce shoreline erosion?</b>	(see p.62)
L 3	Average width and characteristics of vegetation along the lakeshore ( <i>do not include aquatic bed</i> ): ( <i>choose the highest scoring description that matches conditions in the wetland</i> ) • 3/4 of distance is shrubs or forest at least 33 ft. (10m) wide ..... points = 6 • 3/4 of distance is shrubs or forest at least 6 ft. (2m) wide..... points = 4 • 1/4 of distance is shrubs or forest at least 33 ft. (10m) wide..... points = 4 • Vegetation is at least 6 ft. (2m) wide (any type except aquatic bed)..... points = 2 • Vegetation is less than 6 ft. (2m) wide (any type except aquatic bed) ..... points = 0 <b>Aerial photo or map with Cowardin vegetation classes</b>	<b>Figure</b> ____ 2
<i>Record the points in the boxes above</i>		<b>2</b>
<b>L 4</b>	<b>Does the wetland have the <u>opportunity</u> to reduce erosion?</b>	(see p. 64)
Are there features along the shore that will be impacted if the shoreline erodes? <i>Note which of the following conditions apply.</i> <input checked="" type="checkbox"/> There are human structures and activities along the upland edge of the wetland (buildings, fields) that can be damaged by erosion. ____ There are undisturbed natural resources along the upland edge of the wetland (e.g. mature forests, other wetlands) that can be damaged by shoreline erosion. ____ Other _____ YES multiplier is 2 NO multiplier is 1		Multiplier X2
<b>◆</b>	<b>TOTAL – Hydrologic Functions</b> Multiply the score from L3 by L4; then <i>add score to table on p. 1</i>	<b>4</b>

Comments: Deck, shed, and walkways in wetland.





These questions apply to wetlands of all HGM classes.		Points
HABITAT FUNCTIONS – Indicators that wetland functions to provide important habitat.		(only 1 score per box)
<b>H 1</b>	<b>Does the wetland have the <u>potential</u> to provide habitat for many species?</b>	
H 1.1	<p><u>Vegetation structure</u> (see P. 72):                      Check the types of vegetation classes present (as defined by Cowardin) – Size threshold for each class is 1/4 acre or more than 10% of the area if unit is smaller than 2.5 acres.</p> <p><input type="checkbox"/> Aquatic Bed  <input checked="" type="checkbox"/> Emergent plants  <input checked="" type="checkbox"/> Scrub/shrub (areas where shrubs have &gt; 30% cover)  <input type="checkbox"/> Forested (areas where trees have &gt; 30% cover)</p> <p>If the unit has a forested class check if:  <input type="checkbox"/> The forested class has 3 out of 5 strata (canopy, sub-canopy, shrubs, herbaceous, moss/ground-cover) that each cover 20% within the forested polygon.                      Add the number of vegetation types that qualify. If you have:</p> <p style="text-align: right;"><b>Map of Cowardin vegetation classes</b></p> <p style="text-align: right;">4 structures or more ..... points = 4                      3 structures ..... points = 2                      2 structures ..... points = 1                      1 structure ..... points = 0</p>	Figure ____  1
H 1.2	<p><u>Hydroperiods</u> (see p.73):                      Check the types of water regimes (hydroperiods) present within the wetland. The water regime has to cover more than 10% of the wetland or 1/4 acre to count (see text for descriptions of hydroperiods).</p> <p><input type="checkbox"/> Permanently flooded or inundated  <input type="checkbox"/> Seasonally flooded or inundated  <input type="checkbox"/> Occasionally flooded or inundated  <input type="checkbox"/> Saturated only  <input type="checkbox"/> Permanently flowing stream or river in, or adjacent to, the wetland  <input type="checkbox"/> Seasonally flowing stream in, or adjacent to, the wetland  <input checked="" type="checkbox"/> <b>Lake-fringe wetland ..... = 2 points</b>  <input type="checkbox"/> <b>Freshwater tidal wetland ..... = 2 points</b></p> <p style="text-align: right;"><b>Map of hydroperiods</b></p> <p style="text-align: right;">4 or more types present points = 3                      3 or more types present ..... points = 2                      2 types present ..... points = 1                      1 type present ..... points = 0</p>	Figure ____  2
H 1.3	<p><u>Richness of Plant Species</u> (see p. 75):                      Count the number of plant species in the wetland that cover at least 10 ft<sup>2</sup> (different patches of the same species can be combined to meet the size threshold)                      You do not have to name the species. Do not include Eurasian Milfoil, reed canarygrass, purple loosestrife, Canadian Thistle.</p> <p>If you counted: &gt; 19 species ..... points = 2                      5 – 19 species ..... points = 1                      &lt; 5 species ..... points = 0</p> <p>List species below if you want to:                      _____                      _____                      _____</p>	1
H 1.4	<p><u>Interspersion of Habitats</u> (see p. 76):                      Decided from the diagrams below whether interspersion between Cowardin vegetation (described in H1.1), or the classes and unvegetated areas (can include open water or mudflats) is high, medium, low, or none.</p> <div style="display: flex; justify-content: space-around;"> <div style="text-align: center;">  <p>None = 0 points</p> </div> <div style="text-align: center;">  <p>Low = 1 point</p> </div> <div style="text-align: center;">  <p>Moderate = 2 points</p> </div> <div style="text-align: center;">  <p>High = 3 points</p> </div> </div> <p style="text-align: center;">[riparian braided channels]</p> <p>Note: If you have 4 or more classes or 3 vegetation classes and open water, the rating is always “high”.</p> <p style="text-align: right;"><b>Use map of Cowardin classes.</b></p>	Figure ____  1
H 1.5	<p><u>Special Habitat Features</u> (see p. 77):                      Check the habitat features that are present in the wetland. The number of checks is the number of points you put into the next column.</p> <p><input type="checkbox"/> Large, downed, woody debris within the wetland (&gt; 4 in. diameter and 6 ft. long)  <input type="checkbox"/> Standing snags (diameter at the bottom &gt; 4 inches) in the wetland  <input type="checkbox"/> Undercut banks are present for at least 6.6 ft. (2m) and/or overhanging vegetation extends at least 3.3 ft. (1m) over a stream (or ditch) in, or contiguous with the unit, for at least 33 ft. (10m)  <input type="checkbox"/> Stable steep banks of fine material that might be used by beaver or muskrat for denning (&gt; 30 degree slope) OR signs of recent beaver activity are present (cut shrubs or trees that have not yet turned grey/brown)  <input type="checkbox"/> At least 1/4 acre of thin-stemmed persistent vegetation or woody branches are present in areas that are permanently or seasonally inundated (structures for egg-laying by amphibians)  <input type="checkbox"/> Invasive plants cover less than 25% of the wetland area in each stratum of plants</p> <p>NOTE: The 20% stated in early printings of the manual on page 78 is an error.</p>	0
<b>H 1 TOTAL Score</b> – potential for providing habitat		5

Exhibit 16  
 SSSP 2016-00215  
 001096



	<p>H 2.3 <u>Near or adjacent to other priority habitats listed by WDFW</u> (see p. 82): (see new and complete descriptions of WDFW priority habitats, and the counties in which they can be found, in the PHS report <a href="http://wdfw.wa.gov/hab/phslist.htm">http://wdfw.wa.gov/hab/phslist.htm</a> )</p> <p>Which of the following priority habitats are within 330 ft. (100m) of the wetland unit?  <i>NOTE: the connections do not have to be relatively undisturbed.</i></p> <p><input type="checkbox"/> <b>Aspen Stands:</b> Pure or mixed stands of aspen greater than 0.4 ha (1 acre).</p> <p><input type="checkbox"/> <b>Biodiversity Areas and Corridors:</b> Areas of habitat that are relatively important to various species of native fish and wildlife (full descriptions in WDFW PHS report p. 152).</p> <p><input type="checkbox"/> <b>Herbaceous Balds:</b> Variable size patches of grass and forbs on shallow soils over bedrock.</p> <p><input type="checkbox"/> <b>Old-growth/Mature forests:</b> (Old-growth west of Cascade crest) Stands of at least 2 tree species, forming a multi-layered canopy with occasional small openings; with at least 20 trees/ha (8 trees/acre) &gt; 81 cm (32 in) dbh or &gt; 200 years of age. (Mature forests) Stands with average diameters exceeding 53 cm (21 in) dbh; crown cover may be less than 100%; decay, decadence, numbers of snags, and quantity of large downed material is generally less than that found in old-growth; 80 - 200 years old west of the Cascade crest.</p> <p><input type="checkbox"/> <b>Oregon white Oak:</b> Woodlands Stands of pure oak or oak/conifer associations where canopy coverage of the oak component is important (full descriptions in WDFW PHS report p. 158).</p> <p><input type="checkbox"/> <b>Riparian:</b> The area adjacent to aquatic systems with flowing water that contains elements of both aquatic and terrestrial ecosystems which mutually influence each other.</p> <p><input type="checkbox"/> <b>Westside Prairies:</b> Herbaceous, non-forested plant communities that can either take the form of a dry prairie or a wet prairie (full descriptions in WDFW PHS report p. 161).</p> <p><input type="checkbox"/> <b>Instream:</b> The combination of physical, biological, and chemical processes and conditions that interact to provide functional life history requirements for instream fish and wildlife resources.</p> <p><input type="checkbox"/> <b>Nearshore:</b> Relatively undisturbed nearshore habitats. These include Coastal Nearshore, Open Coast Nearshore, and Puget Sound Nearshore. (full descriptions of habitats and the definition of relatively undisturbed are in WDFW report: pp. 167-169 and glossary in Appendix A).</p> <p><input type="checkbox"/> <b>Caves:</b> A naturally occurring cavity, recess, void, or system of interconnected passages under the earth in soils, rock, ice, or other geological formations and is large enough to contain a human.</p> <p><input type="checkbox"/> <b>Cliffs:</b> Greater than 7.6 m (25 ft) high and occurring below 5000 ft.</p> <p><input type="checkbox"/> <b>Talus:</b> Homogenous areas of rock rubble ranging in average size 0.15 - 2.0 m (0.5 - 6.5 ft), composed of basalt, andesite, and/or sedimentary rock, including riprap slides and mine tailings. May be associated with cliffs.</p> <p><input type="checkbox"/> <b>Snags and Logs:</b> Trees are considered snags if they are dead or dying and exhibit sufficient decay characteristics to enable cavity excavation/use by wildlife. Priority snags have a diameter at breast height of &gt; 51 cm (20 in) in western Washington and are &gt; 2 m (6.5 ft) in height. Priority logs are &gt; 30 cm (12 in) in diameter at the largest end, and &gt; 6 m (20 ft) long.</p> <p>If wetland has <b>3 or more</b> priority habitats = <b>4 points</b>                  If wetland has <b>2</b> priority habitats = <b>3 points</b>                  If wetland has <b>1</b> priority habitat = <b>1 point</b>                      <b>No habitats = 0 points</b></p> <p>Note: All vegetated wetlands are by definition a priority habitat but are not included in this list. Nearby wetlands are addressed in question H 2.4)</p>	0
	<p>H 2.4 <u>Wetland Landscape:</u> Choose the <b>one</b> description of the landscape around the wetland that best fits (see p. 84)</p> <ul style="list-style-type: none"> <li>• There are at least 3 other wetlands within 1/2 mile, and the connections between them are relatively undisturbed (light grazing between wetlands OK, as is lake shore with some boating, but connections should NOT be bisected by paved roads, fill, fields, or other development.....points = 5</li> <li>• The wetland is Lake-fringe on a lake with little disturbance and there are 3 other lake-fringe wetlands within 1/2 mile .....points = 5</li> <li>• There are at least 3 other wetlands within 1/2 mile, BUT the connections between them are disturbed.....points = 3</li> <li>• The wetland fringe on a lake <b>with</b> disturbance and there are 3 other lake-fringe wetlands within 1/2 mile .....points = 3</li> <li>• There is at least 1 wetland within 1/2 mile .....points = 2</li> <li>• There are no wetlands within 1/2 mile.....points = 0</li> </ul>	3
	<p><b>H 2 TOTAL Score</b> – opportunity for providing habitat                      Add the scores from H2.1, H2.2, H2.3, H2.4</p>	5
	<p style="text-align: right;">TOTAL for H 1 from page 8</p>	5
◆	<p><b>Total Score for Habitat Functions</b>                      Add the points for H 1 and H 2; then <b>record the result on p. 1</b></p>	10

Comments:

### CATEGORIZATION BASED ON SPECIAL CHARACTERISTICS

*Please determine if the wetland meets the attributes described below and circle the appropriate answers and Category.*

<b>Wetland Type</b> – Check off any criteria that apply to the wetland. Circle the Category when the appropriate criteria are met.	
<b>SC1</b>	<p><b>Estuarine wetlands?</b> (see p.86)</p> <p>Does the wetland unit meet the following criteria for Estuarine wetlands?</p> <p><input type="checkbox"/> The dominant water regime is tidal,  <input type="checkbox"/> Vegetated, and  <input type="checkbox"/> With a salinity greater than 0.5 ppt.</p> <p>YES = Go to SC 1.1    NO <u>  X  </u></p>
	<p>SC 1.1 Is the wetland unit within a National Wildlife Refuge, National Park, National Estuary Reserve, Natural Area Preserve, State Park or Educational, Environmental, or Scientific Reserve designated under WAC 332-30-151?    YES = Category I    NO = go to SC 1.2</p>
	<p>SC 1.2 Is the wetland at least 1 acre in size and meets at least two of the following conditions?            YES = Category I    NO = Category II</p> <p><input type="checkbox"/> The wetland is relatively undisturbed (has no diking, ditching, filling, cultivation, grazing, and has less than 10% cover of non-native plant species. If the non-native <i>Spartina</i> spp., are only species that cover more than 10% of the wetland, then the wetland should be given a dual rating (I/II). The area of <i>Spartina</i> would be rated a Category II while the relatively undisturbed upper marsh with native species would be a Category I. Do not, however, exclude the area of <i>Spartina</i> in determining the size threshold of 1 acre.</p> <p><input type="checkbox"/> At least 3/4 of the landward edge of the wetland has a 100 ft. buffer of shrub, forest, or un-grazed or un-mowed grassland</p> <p><input type="checkbox"/> The wetland has at least 2 of the following features: tidal channels, depressions with open water, or contiguous freshwater wetlands.</p>
<b>SC2</b>	<p><b>Natural Heritage Wetlands</b> (see p. 87)</p> <p>Natural Heritage wetlands have been identified by the Washington Natural Heritage Program/DNR as either high quality undisturbed wetlands or wetlands that support state Threatened, Endangered, or Sensitive plant species.</p> <p>SC 2.1 Is the wetland being rated in a Section/Township/Range that contains a natural heritage wetland? (This question is used to screen out most sites before you need to contact WNHP/DNR.)            S/T/R information from Appendix D _____ or accessed from WNHP/DNR web site _____            YES _____ Contact WNHP/DNR (see p. 79) and go to SC 2.2    NO <u>  X  </u></p> <p>SC 2.2 Has DNR identified the wetland as a high quality undisturbed wetland or as a site with state threatened or endangered plant species?            YES = Category 1    NO _____ not a Heritage Wetland</p>
<b>SC3</b>	<p><b>Bogs</b> (see p. 87)</p> <p>Does the wetland <b>(or any part of the unit)</b> meet both the criteria for soils and vegetation in bogs? Use the key below to identify if the wetland is a bog. <i>If you answer yes you will still need to rate the wetland based on its function.</i></p> <p>1. Does the unit have organic soil horizons (i.e. layers of organic soil), either peats or mucks, that compose 16 inches or more of the first 32 inches of soil profile? (See Appendix B for a field key to identify organic soils)?    YES = go to question 3    <b>NO = go to question 2</b></p> <p>2. Does the wetland have organic soils, either peats or mucks that are less than 16 inches deep over bedrock, or an impermeable hardpan such as clay or volcanic ash, or that are floating on a lake or pond?    YES = go to question 3    <b>NO = is not a bog for purpose of rating</b></p> <p>3. Does the unit have more than 70% cover of mosses at ground level, AND other plants, if present, consist of the “bog” species listed in Table 3 as a significant component of the vegetation (more than 30% of the total shrub and herbaceous cover consists of species in Table 3)?            YES = Is a bog for purpose of rating    NO = go to question 4</p> <p>NOTE: If you are uncertain about the extent of mosses in the understory you may substitute that criterion by measuring the pH of the water that seeps into a hole dug at least 16” deep. If the pH is less than 5.0 and the “bog” plant species in Table 3 are present, the wetland is a bog.</p> <p>4. Is the unit forested (&gt; 30% cover) with sitka spruce, subalpine fir, western red cedar, western hemlock, lodgepole pine, quaking aspen, Englemann’s spruce, or western white pine. WITH any of the species (or combination of species) on the bog species plant list in Table 3 as a significant component of the ground cover (&gt; 30% coverage of the total shrub/herbaceous cover)?            YES = Category I    NO = Is not a bog for purpose of rating</p>
	<b>Cat. I</b>

**Exhibit 16  
SSDP2016-00415  
001099**



<p><b>SC4</b></p>	<p><b>Forested Wetlands</b> (see p. 90)                  Does the wetland have at least 1 acre of forest that meet one of these criteria for the Department of Fish and Wildlife's forests as priority habitats? <i>If you answer yes you will still need to rate the wetland based on its function.</i>                  ___ <b>Old-growth forests:</b> (west of Cascade Crest) Stands of at least two three species forming a multi-layered canopy with occasional small openings; with at least 8 trees/acre (20 trees/hectare) that are at least 200 years of age OR have a diameter at breast height (dbh) of 32 inches (81 cm or more).                  NOTE: The criterion for dbh is based on measurements for upland forests. Two-hundred year old trees in wetlands will often have a smaller dbh because their growth rates are often slower. The DFW criterion is and "OR" so old-growth forests do not necessarily have to have trees of this diameter.                  ___ <b>Mature forests:</b> (west of the Cascade Crest) Stands where the largest trees are 80 – 200 years old OR have an average diameters (dbh) exceeding 21 inches (53 cm); crown cover may be less than 100%; decay, decadence, numbers of snags, and quantity of large downed material is generally less than that found in old-growth.                  YES = Category I                      NO = <u>X</u> not a forested wetland with special characteristics</p>	<p><b>Cat. I</b></p>
<p><b>SC5</b></p>	<p><b>Wetlands in Coastal Lagoons</b> (see p. 91)                  Does the wetland meet all of the following criteria of a wetland in a coastal lagoon?                  ___ The wetland lies in a depression adjacent to marine waters that is wholly or partially separated from marine waters by sandbanks, gravel banks, shingle, or, less frequently, rocks.                  ___ The lagoon in which the wetland is located contains surface water that is saline or brackish (&gt; 0.5 ppt) during most of the year in at least a portion of the lagoon (<i>needs to be measured near the bottom.</i>)                  YES = Go to SC 5.1                      NO <u>X</u> not a wetland in a coastal lagoon                  SC 5.1 Does the wetland meet all of the following three conditions?                  ___ The wetland is relatively undisturbed (has no diking, ditching, filling, cultivation, grazing) and has less than 20% cover of invasive plant species (see list of invasive species on p. 74).                  ___ At least 3/4 of the landward edge of the wetland has a 100 ft. buffer of shrub, forest, or un-grazed or un-mowed grassland.                  ___ The wetland is larger than 1/10 acre (4350 square ft.)                  YES = Category I                      NO = Category II</p>	<p><b>Cat. I</b>  <b>Cat. II</b></p>
<p><b>SC6</b></p>	<p><b>Interdunal Wetlands</b> (see p. 93)                  Is the wetland west of the 1889 line (also called the Western Boundary of Upland Ownership or WBUO)?                  YES = Go to SC 6.1                      NO <u>X</u> not an interdunal wetland for rating  <i>If you answer yes you will still need to rate the wetland based on its functions.</i>                  In practical terms that means the following geographic areas:                  • Long Beach Peninsula -- lands west of SR 103                  • Grayland-Westport -- lands west of SR 105                  • Ocean Shores-Copalis – lands west of SR 115 and SR 109                  SC 6.1 Is the wetland one acre or larger, or is it in a mosaic of wetlands that is one acre or larger?                  YES = Category II                      NO = go to SC 6.2                  SC 6.2 Is the wetland between 0.1 and 1 acre, or is it in a mosaic of wetlands that is between 0.1 and 1 acre?                  YES = Category III</p>	<p><b>Cat. II</b>  <b>Cat. III</b></p>
<p>◆</p>	<p><b>Category of wetland based on Special Characteristics</b>                  Choose the "highest" rating if wetland falls into several categories, and record on p. 1.                  If you answered NO for all types enter "Not Applicable" on p. 1</p>	<p><b>NA</b></p>

**Comments:**

Wetland name or number 23C

**WETLAND RATING FORM – WESTERN WASHINGTON**  
Version 2 – Updated July 2006 to increase accuracy and reproducibility among users  
Updated Oct. 2008 with the new WDFW definitions for priority habitats

Name of wetland (if known): 23C Date of site visit: 09-20-13

Rated by: Colin Worsley / Matt Maynard Trained by Ecology? Yes X No      Date of training: 11-2005 / 04-2006

SEC: 06 TOWNSHIP: 24N RANGE: 06E Is S/T/R in Appendix D? Yes      No X

Map of wetland unit: Figure      Estimated size 0.08 acre

**SUMMARY OF RATING**

Category based on FUNCTIONS provided by wetland: I      II      III X IV     

Category I =	Score > 70
Category II =	Score 51 - 69
Category III =	Score 30 – 50
Category IV =	Score < 30

Score for Water Quality Functions	10
Score for Hydrologic Functions	14
Score for Habitat Functions	14
<b>TOTAL Score for Functions</b>	<b>38</b>

Category based on SPECIAL CHARACTERISTICS of Wetland I      II      Does not apply X

**Final Category** (choose the “highest” category from above”) **III**

**Summary of basic information about the wetland unit.**

Wetland Unit has Special Characteristics		Wetland HGM Class used for Rating	
<b>Estuarine</b>		<b>Depressional</b>	<b>X</b>
<b>Natural Heritage Wetland</b>		<b>Riverine</b>	
<b>Bog</b>		<b>Lake-fringe</b>	
<b>Mature Forest</b>		<b>Slope</b>	
<b>Old Growth Forest</b>		<b>Flats</b>	
<b>Coastal Lagoon</b>		<b>Freshwater Tidal</b>	
<b>Interdunal</b>			
None of the above	X	Check if unit has multiple HGM classes present	<span style="border: 1px solid black; padding: 2px 5px;">    </span>

**Does the wetland being rated meet any of the criteria below?** If you answer YES to any of the questions below you will need to protect the wetland according to the regulations regarding the special characteristics found in the wetland.

Check List for Wetlands that Need Additional Protection (in addition to the protection recommended for its category)	YES	NO
SP1. <i>Has the wetland unit been documented as a habitat for any Federally listed Threatened or Endangered <b>animal or plant</b> species (T/E species)?</i> For the purposes of this rating system, “documented” means the wetland is on the appropriate state or federal database.		X
SP2. <i>Has the wetland unit been documented as habitat for any State listed Threatened or Endangered <b>animal</b> species?</i> For the purposes of this rating system, “documented” means the wetland is on the appropriate state database. Note: Wetlands with State listed plant species are categorized as Category 1 Natural Heritage Wetlands (see p. 19 of data form).		X
SP3. <i>Does the wetland unit contain individuals of Priority species listed by the WDFW for the state?</i>		X
SP4. <i>Does the wetland unit have a local significance in addition to its functions?</i> For example, the wetland has been identified in the Shoreline Master Program, the Critical Areas Ordinance, or in a local management plan as having special significance.		X

To complete the next part of the data sheet you will need to determine the Hydrogeomorphic Class of the wetland being rated. Exhibit 16  
SSDP2016-00415

### Classification of Vegetated Wetlands for Western Washington

If the hydrologic criteria listed in each question do not apply to the entire unit being rated, you probably have a unit with multiple HGM classes. In this case, identify which hydrologic criteria in questions 1-7 apply, and go to Question 8.

1. Are the water levels in the entire unit usually controlled by tides (i.e. except during floods)?  
NO – go to 2                      **YES – the wetland class is Tidal Fringe**  
 If yes, is the salinity of the water during periods of annual low flow below 0.5 ppt (parts per thousand)?  
**YES – Freshwater Tidal Fringe**                      **NO – Saltwater Tidal Fringe (Estuarine)**  
*If your wetland can be classified as a Freshwater Tidal Fringe use the forms for Riverine wetlands. If it is a Saltwater Tidal Fringe it is rated as an Estuarine wetland. Wetlands that were call estuarine in the first and second editions of the rating system are called Salt Water Tidal Fringe in the Hydrogeomorphic Classification. Estuarine wetlands were categorized separately in the earlier editions, and this separation is being kept in this revision. To maintain consistency between editions, the term “Estuarine” wetland is kept. Please note, however, that the characteristics that define Category I and II estuarine wetlands have changed (see p. \_\_\_\_).*

---

2. The entire wetland unit is flat and precipitation is only source (>90%) of water to it. Groundwater and surface water runoff are NOT sources of water to the unit.  
NO – go to 3                      **YES – The wetland class is Flats**  
 If your wetland can be classified as a “Flats” wetland, use the form for **Depressional** wetlands.

---

3. Does the entire wetland meet both of the following criteria?  
 \_\_\_\_\_ The vegetated part of the wetland is on the shores of a body of permanent open water (without any vegetation on the surface) where at least 20 acres (8ha) in size;  
 \_\_\_\_\_ At least 30% of the open water area is deeper than 6.6 (2 m)?  
NO – go to 4                      **YES – The wetland class is Lake-fringe (Lacustrine Fringe)**

---

4. Does the entire wetland meet all of the following criteria?  
 \_\_\_\_\_ The wetland is on a slope (*slope can be very gradual*).  
 \_\_\_\_\_ The water flows through the wetland in one direction (unidirectional) and usually comes from seeps. It may flow subsurface, as sheetflow, or in a swale without distinct banks.  
 \_\_\_\_\_ The water leaves the wetland **without being impounded**?  
 NOTE: *Surface water does not pond in these types of wetlands except occasionally in very small and shallow depressions or behind hummocks (depressions are usually <3 ft diameter and less than 1 foot deep).*  
NO – go to 5                      **YES – The wetland class is Slope**

---

5. Does the entire wetland meet all of the following criteria?  
 \_\_\_\_\_ The unit is in a valley or stream channel where it gets inundated by overbank flooding from that stream or river.  
 \_\_\_\_\_ The overbank flooding occurs at least once every two years.  
 NOTE: *The riverine unit can contain depressions that are filled with water when the river is not flooding..*  
NO – go to 6                      **YES – The wetland class is Riverine**

---

6. Is the entire wetland unit in a topographic depression in which water ponds, or is saturated to the surface, at some time of the year. This means that any outlet, if present is higher than the interior of the wetland.  
NO – go to 7                      **YES – The wetland class is Depressional**

---

7. Is the entire wetland located in a very flat area with no obvious depression and no overbank flooding. The unit does not pond surface water more than a few inches. The unit seems to be maintained by high groundwater in the area. The wetland may be ditched, but has no obvious natural outlet.  
No – go to 8                      **YES – The wetland class is Depressional**

---

8. Your wetland unit seems to be difficult to classify and probably contains several different HGM classes. For example, seeps at the base of a slope may grade into a riverine floodplain, or a small stream within a depressional wetland has a zone of flooding along its sides. **GO BACK AND IDENTIFY WHICH OF THE HYDROLOGIC REGIMES DESCRIBED IN QUESTIONS 1-7 APPLY TO DIFFERENT AREAS IN THE UNIT** (make a rough sketch to help you decide). Use the following table to identify the appropriate class to use for the rating system if you have several HGM classes present within your wetland. NOTE: Use this table only if the class that is recommended in the second column represents 10% or more of the total area of the wetland unit being rated. If the area of the class listed in column 2 is less than 10% of the unit, classify the wetland using the class that represents more than 90% of the total area.

HGM Classes within the wetland unit being rated	HGM Class to Use in Rating
Slope + Riverine	Riverine
Slope + Depressional	Depressional
Slope + Lake-fringe	Lake-fringe
Depressional + Riverine along stream within boundary	Depressional
Depressional + Lake-fringe	Depressional
Salt Water Tidal Fringe and any other class of freshwater wetland	Treat as ESTUARINE under wetlands with special characteristics

**Exhibit 16**  
**SSDP2016-00415**  
**001102**

If you are unable still to determine which of the above criteria apply to your wetland, or you have more than 2 HGM classes within a wetland boundary, classify the wetland as **Depressional** for the rating.

<b>D Depressional and Flat Wetlands</b>		<b>Points</b>
<b>WATER QUALITY FUNCTIONS – Indicators that wetland functions to improve water quality.</b>		(only 1 score per box) <i>(see p.38)</i>
<b>D 1</b>	<b>Does the wetland have the <u>potential</u> to improve water quality?</b>	
D 1.1	Characteristics of surface water flows out of the wetland: <ul style="list-style-type: none"> <li>• Unit is a depression with no surface water leaving it (no outlet)..... points = 3</li> <li>• <b>Unit has an intermittently flowing, OR highly constricted, permanently flowing outlet .....</b> points = <b>2</b></li> <li>• Unit has an unconstricted, or slightly constricted, surface outlet (<i>permanently flowing</i>) ..... points = 1</li> <li>• Unit is a “flat” depression (Q.7 on key), or in the Flats class, with permanent surface outflow <b>and no obvious natural outlet</b> and/or outlet is a man-made ditch..... points = 1 <i>(If ditch is not permanently flowing treat unit as “intermittently flowing”)</i> <b>Provide photo or drawing</b></li> </ul>	<b>Figure</b> ___  2
D 1.2	The soil 2 inches below the surface (or duff layer) is clay or organic ( <i>use NRCS definitions</i> ) YES points = 4    NO points = 0	0
D 1.3	Characteristics of persistent vegetation (emergent, shrub, and/or forest Cowardin class): <ul style="list-style-type: none"> <li>• Wetland has persistent, ungrazed vegetation &gt; = 95% of area..... points = 5</li> <li>• <b>Wetland has persistent, ungrazed vegetation &gt; = 1/2 of area.....</b> points = <b>3</b></li> <li>• Wetland has persistent, ungrazed vegetation &gt; = 1/10 of area..... points = 1</li> <li>• Wetland has persistent, ungrazed vegetation &lt; 1/10 of area..... points = 0</li> </ul> <p style="text-align: center;"><b>Map of Cowardin vegetation classes</b></p>	<b>Figure</b> ___  3
D 1.4	Characteristics of seasonal ponding or inundation: <i>This is the area of the wetland that is ponded for at least 2 months, but dries out sometime during the year. Do not count the area that is permanently ponded. Estimate area as the average condition 5 out of 10 years.</i> <ul style="list-style-type: none"> <li>• Area seasonally ponded is &gt; 1/2 total area of wetland ..... points = 4</li> <li>• Area seasonally ponded is &gt; 1/4 total area of wetland ..... points = 2</li> <li>• <b>Area seasonally ponded is &lt; 1/4 total area of wetland .....</b> points = <b>0</b></li> </ul> <p style="text-align: center;"><b>Map of Hydroperiods</b></p>	<b>Figure</b> ___  0
<b>Total for D 1</b>		<i>Add the points in the boxes above</i> <b>5</b>
<b>D 2</b>	<b>Does the wetland have the <u>opportunity</u> to improve water quality?</b>	<i>(see p. 44)</i>
Answer YES if you know or believe there are pollutants in groundwater or surface water coming into the wetland that would otherwise reduce water quality in streams, lakes or groundwater downgradient from the wetland? <i>Note which of the following conditions provide the sources of pollutants. A unit may have pollutants coming from several sources, but any single source would qualify as opportunity.</i> ___ Grazing in the wetland or within 150 ft ___ Untreated stormwater discharges to wetland ___ Tilled fields or orchards within 150 ft. of wetland ___ A stream or culvert discharges into wetland that drains developed areas, residential areas, farmed fields, roads, or clear-cut logging <u>X</u> Residential, urban areas, golf courses are within 150 ft. of wetland ___ Wetland is fed by groundwater high in phosphorus or nitrogen ___ Other _____ <div style="display: flex; justify-content: space-between; width: 100%;"> <span>YES multiplier is <b>2</b></span> <span>NO multiplier is 1</span> </div>		Multiplier  X2
<b>◆ TOTAL – Water Quality Functions</b> Multiply the score from D1 by D2; then <b>add score to table on p. 1</b>		<b>10</b>
<b>HYDROLOGIC FUNCTIONS – Indicators that wetland unit functions to reduce flooding and stream degradation.</b>		
<b>D 3</b>	<b>Does the wetland have the <u>potential</u> to reduce flooding and erosion?</b>	<i>(see p.46)</i>
D 3.1	Characteristics of surface water flows out of the wetland unit <ul style="list-style-type: none"> <li>• Unit is a depression with no surface water leaving it (no outlet)..... points = 4</li> <li>• <b>Unit has an intermittently flowing, OR highly constricted permanently flowing outlet .....</b> points = <b>2</b></li> <li>• Unit is a “flat” depression (Q.7 on key) or in the Flats class, with permanent surface outflow <b>and no obvious natural outlet</b> and/or outlet is a man-made ditch..... points = 1 <i>(If ditch is not permanently flowing treat unit as “intermittently flowing”)</i></li> <li>• Unit has an unconstricted, or slightly constricted, surface outlet (<i>permanently flowing</i>) ..... points = 0</li> </ul>	2
D 3.2	Depth of storage during wet periods. <i>Estimate the height of ponding above the bottom of the outlet. For units with no outlet measure from the surface of permanent water or deepest part (if dry).</i> <ul style="list-style-type: none"> <li>• Marks of ponding are 3 ft. or more above the surface or bottom of the outlet ..... points = 7</li> <li>• The wetland is a “headwater” wetland..... points = 5</li> <li>• Marks of ponding between 2 ft. to &lt; 3 ft. from surface or bottom of outlet ..... points = 5</li> <li>• Marks are at least 0.5 ft. to &lt; 2 ft. from surface or bottom of outlet..... points = 3</li> <li>• Wetland is flat (yes to Q.2 or Q.7 on key)but has small depressions on the surface that trap water points = 1</li> <li>• <b>Marks of ponding less than 0.5 ft .....</b> points = <b>0</b></li> </ul>	0
D 3.3	Contribution of wetland unit to storage in the watershed: <i>Estimate the ratio of the area of upstream basin contributing surface water to the wetland to the area of the wetland unit itself.</i> <ul style="list-style-type: none"> <li>• <b>The area of the basin is less than 10 times the area of unit.....</b> points = <b>5</b></li> <li>• The area of the basin is 10 to 100 times the area of the unit ..... points = 3</li> <li>• The area of the basin is more than 100 times the area of the unit ..... points = 0</li> <li>• Entire unit is in the FLATS class ..... points = 5</li> </ul>	5
<b>Total for D 3</b>		<i>Add the points in the boxes above</i> <b>7</b>

**Exhibit 16  
SSDP2016-00415  
001103**

<b>D 4</b>	<p><b>Does the wetland have the <u>opportunity</u> to reduce flooding and erosion?</b></p> <p>Answer YES if the unit is in a location in the watershed where the flood storage, or reduction in water velocity, it provides helps protect downstream property and aquatic resources from flooding or excessive and/or erosive flows. Answer NO if the water coming into the wetland is controlled by a structure such as flood gate, tide gate, flap valve, reservoir etc. OR you estimate that more than 90% of the water in the wetland is from groundwater in areas where damaging groundwater flooding does not occur. <i>Note which of the following indicators of opportunity apply.</i></p> <p><input type="checkbox"/> Wetland is in a headwater of a river or stream that has flooding problems.</p> <p><input type="checkbox"/> Wetland drains to a river or stream that has flooding problems</p> <p><input checked="" type="checkbox"/> Wetland has no outlet and impounds surface runoff water that might otherwise flow into a river or stream that has flooding problems</p> <p><input type="checkbox"/> Other _____</p> <p><b>YES multiplier is 2</b>                      NO multiplier is 1</p>	<p>(see p. 49)</p> <p>Multiplier</p> <p><u>X2</u></p>
◆	<p><b>TOTAL – Hydrologic Functions</b>                      Multiply the score from D3 by D4; then <i>add score to table on p. 1</i></p>	<p>14</p>

Comments:





<p><i>These questions apply to wetlands of all HGM classes.</i></p> <p>HABITAT FUNCTIONS – Indicators that wetland functions to provide important habitat.</p>		<p><b>Points</b> (only 1 score per box)</p>
<b>H 1</b>	<p><b>Does the wetland have the potential to provide habitat for many species?</b></p>	
H 1.1	<p><u>Vegetation structure</u> (see P. 72):                      Check the types of vegetation classes present (as defined by Cowardin) – Size threshold for each class is 1/4 acre or more than 10% of the area if unit is smaller than 2.5 acres.</p> <p><input type="checkbox"/> Aquatic Bed  <input checked="" type="checkbox"/> Emergent plants  <input checked="" type="checkbox"/> Scrub/shrub (areas where shrubs have &gt; 30% cover)  <input type="checkbox"/> Forested (areas where trees have &gt; 30% cover)</p> <p>If the unit has a forested class check if:  <input type="checkbox"/> The forested class has 3 out of 5 strata (canopy, sub-canopy, shrubs, herbaceous, moss/ground-cover) that each cover 20% within the forested polygon.                      Add the number of vegetation types that qualify. If you have:</p> <p style="text-align: right;"> <b>Map of Cowardin vegetation classes</b>                      4 structures or more ..... points = 4                      3 structures ..... points = 2                      2 structures ..... points = 1                      1 structure ..... points = 0                 </p>	<p><b>Figure</b> ____</p> <p style="text-align: right;">1</p>
H 1.2	<p><u>Hydroperiods</u> (see p.73):                      Check the types of water regimes (hydroperiods) present within the wetland. The water regime has to cover more than 10% of the wetland or 1/4 acre to count (see text for descriptions of hydroperiods).</p> <p><input checked="" type="checkbox"/> Permanently flooded or inundated  <input checked="" type="checkbox"/> Seasonally flooded or inundated  <input checked="" type="checkbox"/> Occasionally flooded or inundated  <input checked="" type="checkbox"/> Saturated only</p> <p><input type="checkbox"/> Permanently flowing stream or river in, or adjacent to, the wetland  <input type="checkbox"/> Seasonally flowing stream in, or adjacent to, the wetland  <input type="checkbox"/> Lake-fringe wetland ..... = 2 points  <input type="checkbox"/> Freshwater tidal wetland ..... = 2 points</p> <p style="text-align: right;"> <b>Map of hydroperiods</b>                      4 or more types present ..... points = 3                      3 or more types present ..... points = 2                      2 types present ..... points = 1                      1 type present ..... points = 0                 </p>	<p><b>Figure</b> ____</p> <p style="text-align: right;">2</p>
H 1.3	<p><u>Richness of Plant Species</u> (see p. 75):                      Count the number of plant species in the wetland that cover at least 10 ft<sup>2</sup> (different patches of the same species can be combined to meet the size threshold)                      You do not have to name the species. Do not include Eurasian Milfoil, reed canarygrass, purple loosestrife, Canadian Thistle.</p> <p>If you counted: &gt; 19 species ..... points = 2                      5 – 19 species ..... points = 1                      &lt; 5 species ..... points = 0</p> <p>List species below if you want to:</p> <p>_____</p> <p>_____</p> <p>_____</p>	<p style="text-align: right;">1</p>
H 1.4	<p><u>Interspersion of Habitats</u> (see p. 76):                      Decided from the diagrams below whether interspersion between Cowardin vegetation (described in H1.1), or the classes and unvegetated areas (can include open water or mudflats) is high, medium, low, or none.</p> <div style="display: flex; justify-content: space-around;"> <div style="text-align: center;">  <p>None = 0 points</p> </div> <div style="text-align: center;">  <p>Low = 1 point</p> </div> <div style="text-align: center;">  <p>Moderate = 2 points</p> </div> </div> <div style="display: flex; justify-content: space-around; margin-top: 20px;"> <div style="text-align: center;">  <p>High = 3 points</p> </div> <div style="text-align: center;">  <p>[riparian braided channels]</p> </div> </div> <p style="text-align: right; margin-top: 20px;"> <b>Note:</b> If you have 4 or more classes or 3 vegetation classes and open water, the rating is always “high”.   <b>Use map of Cowardin classes.</b> </p>	<p><b>Figure</b> ____</p> <p style="text-align: right;">1</p>
H 1.5	<p><u>Special Habitat Features</u> (see p. 77):                      Check the habitat features that are present in the wetland. The number of checks is the number of points you put into the next column.</p> <p><input checked="" type="checkbox"/> Large, downed, woody debris within the wetland (&gt; 4 in. diameter and 6 ft. long)  <input type="checkbox"/> Standing snags (diameter at the bottom &gt; 4 inches) in the wetland  <input type="checkbox"/> Undercut banks are present for at least 6.6 ft. (2m) and/or overhanging vegetation extends at least 3.3 ft. (1m) over a stream (or ditch) in, or contiguous with the unit, for at least 33 ft. (10m)  <input type="checkbox"/> Stable steep banks of fine material that might be used by beaver or muskrat for denning (&gt; 30 degree slope) OR signs of recent beaver activity are present (cut shrubs or trees that have not yet turned grey/brown)  <input type="checkbox"/> At least 1/4 acre of thin-stemmed persistent vegetation or woody branches are present in areas that are permanently or seasonally inundated (structures for egg-laying by amphibians)  <input type="checkbox"/> Invasive plants cover less than 25% of the wetland area in each stratum of plants</p> <p><i>NOTE: The 20% stated in early printings of the manual on page 78 is an error.</i></p>	<p style="text-align: right;">1</p>
<p><b>H 1 TOTAL Score</b> – potential for providing habitat</p>		<p style="text-align: right;">6</p>

Exhibit 16  
SSDP2016-00415  
007165

<b>H 2</b>	<b>Does the wetland have the <u>opportunity</u> to provide habitat for many species?</b>	(only 1 score per box)
	<p>H 2.1 <b>Buffers</b> (see P. 80):  <i>Choose the description that best represents condition of buffer of wetland unit. The highest scoring criterion that applies to the wetland is to be used in the rating. See text for definition of "undisturbed".</i></p> <p><input type="checkbox"/> 100m (330 ft) of relatively undisturbed vegetated areas, rocky areas, or open water &gt; 95% of circumference. No structures are within the undisturbed part of buffer (relatively undisturbed also means no grazing, no landscaping, no daily human use)..... <b>points = 5</b></p> <p><input type="checkbox"/> 100m (330 ft) of relatively undisturbed vegetated areas, rocky areas, or open water &gt; 50% circumference..... <b>points = 4</b></p> <p><input type="checkbox"/> 50m (170 ft) of relatively undisturbed vegetated areas, rocky areas, or open water &gt; 95% circumference..... <b>points = 4</b></p> <p><input type="checkbox"/> 100m (330 ft) of relatively undisturbed vegetated areas, rocky areas, or open water &gt; 25% circumference..... <b>points = 3</b></p> <p><input type="checkbox"/> 50m (170 ft) of relatively undisturbed vegetated areas, rocky areas, or open water for &gt; 50% circumference..... <b>points = 3</b></p> <p><b>If buffer does not meet any of the criteria above:</b></p> <p><input type="checkbox"/> No paved areas (except paved trails) or buildings within 25m (80 ft) of wetland &gt; 95% circumference. Light to moderate grazing or lawns are OK..... <b>points = 2</b></p> <p><input type="checkbox"/> No paved areas of buildings within 50m of wetland for &gt; 50% circumference. Light to moderate grazing or lawns are OK..... <b>points = 2</b></p> <p><input type="checkbox"/> Heavy grazing in buffer..... <b>points = 1</b></p> <p><input type="checkbox"/> Vegetated buffers are &lt; 2m wide (6.6 ft) for more than 95% circumference (e.g. tilled fields, paving, basalt bedrock extend to edge of wetland)..... <b>points = 0</b></p> <p><input checked="" type="checkbox"/> Buffer does not meet any of the criteria above..... <b>points = 1</b></p> <p style="text-align: right;"><b>Arial photo showing buffers</b></p>	<p><b>Figure</b> _____</p> <p style="text-align: center;">1</p>
	<p>H 2.2 <b>Corridors and Connections</b> (see p. 81)</p> <p>H 2.2.1 Is the wetland part of a relatively undisturbed and unbroken vegetated corridor (either riparian or upland) that is at least 150 ft. wide, has at least a 30% cover of shrubs, forest or native undisturbed prairie, that connects to estuaries, other wetlands or undisturbed uplands that are at least 250 acres in size? (<i>Dams in riparian corridors, heavily used gravel roads, paved roads, are considered breaks in the corridor.</i>)                      YES = <b>4 points</b> (go to H 2.3) <span style="background-color: yellow;">NO = go to H 2.2.2</span></p> <p>H. 2.2.2 Is the wetland part of a relatively undisturbed and unbroken vegetated corridor (either riparian or upland) that is at least 50 ft. wide, has at least 30% cover of shrubs or forest, and connects to estuaries, other wetlands or undisturbed uplands that are at least 25 acres in size? <b>OR a Lake-fringe</b> wetland, if it does not have an undisturbed corridor as in the question above?                      YES = <b>2 points</b> (go to H 2.3) <span style="background-color: yellow;">NO = go to H 2.2.3</span></p> <p>H. 2.2.3 Is the wetland:</p> <ul style="list-style-type: none"> <li>• Within 5 mi (8km) of a brackish or salt water estuary OR</li> <li>• Within 3 miles of a large field or pasture (&gt; 40 acres) OR <span style="background-color: yellow;">YES = 1 point</span></li> <li>• <span style="background-color: yellow;">Within 1 mile of a lake greater than 20 acres?</span> <span style="background-color: yellow;">NO = 0 points</span></li> </ul>	<p style="text-align: center;">1</p>

**Comments:**

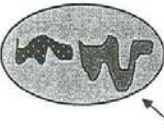
	<p>H 2.3 <u>Near or adjacent to other priority habitats listed by WDFW</u> (see p. 82): (see new and complete descriptions of WDFW priority habitats, and the counties in which they can be found, in the PHS report <a href="http://wdfw.wa.gov/hab/phslist.htm">http://wdfw.wa.gov/hab/phslist.htm</a> )</p> <p>Which of the following priority habitats are within 330 ft. (100m) of the wetland unit?  <i>NOTE: the connections do not have to be relatively undisturbed.</i></p> <p><input type="checkbox"/> <b>Aspen Stands:</b> Pure or mixed stands of aspen greater than 0.4 ha (1 acre).</p> <p><input type="checkbox"/> <b>Biodiversity Areas and Corridors:</b> Areas of habitat that are relatively important to various species of native fish and wildlife (full descriptions in WDFW PHS report p. 152).</p> <p><input type="checkbox"/> <b>Herbaceous Balds:</b> Variable size patches of grass and forbs on shallow soils over bedrock.</p> <p><input type="checkbox"/> <b>Old-growth/Mature forests:</b> (Old-growth west of Cascade crest) Stands of at least 2 tree species, forming a multi-layered canopy with occasional small openings; with at least 20 trees/ha (8 trees/acre) &gt; 81 cm (32 in) dbh or &gt; 200 years of age. (Mature forests) Stands with average diameters exceeding 53 cm (21 in) dbh; crown cover may be less than 100%; decay, decadence, numbers of snags, and quantity of large downed material is generally less than that found in old-growth; 80 - 200 years old west of the Cascade crest.</p> <p><input type="checkbox"/> <b>Oregon white Oak:</b> Woodlands Stands of pure oak or oak/conifer associations where canopy coverage of the oak component is important (full descriptions in WDFW PHS report p. 158).</p> <p><input checked="" type="checkbox"/> <b>Riparian:</b> The area adjacent to aquatic systems with flowing water that contains elements of both aquatic and terrestrial ecosystems which mutually influence each other.</p> <p><input type="checkbox"/> <b>Westside Prairies:</b> Herbaceous, non-forested plant communities that can either take the form of a dry prairie or a wet prairie (full descriptions in WDFW PHS report p. 161).</p> <p><input checked="" type="checkbox"/> <b>Instream:</b> The combination of physical, biological, and chemical processes and conditions that interact to provide functional life history requirements for instream fish and wildlife resources.</p> <p><input type="checkbox"/> <b>Nearshore:</b> Relatively undisturbed nearshore habitats. These include Coastal Nearshore, Open Coast Nearshore, and Puget Sound Nearshore. (full descriptions of habitats and the definition of relatively undisturbed are in WDFW report: pp. 167-169 and glossary in Appendix A).</p> <p><input type="checkbox"/> <b>Caves:</b> A naturally occurring cavity, recess, void, or system of interconnected passages under the earth in soils, rock, ice, or other geological formations and is large enough to contain a human.</p> <p><input type="checkbox"/> <b>Cliffs:</b> Greater than 7.6 m (25 ft) high and occurring below 5000 ft.</p> <p><input type="checkbox"/> <b>Talus:</b> Homogenous areas of rock rubble ranging in average size 0.15 - 2.0 m (0.5 - 6.5 ft), composed of basalt, andesite, and/or sedimentary rock, including riprap slides and mine tailings. May be associated with cliffs.</p> <p><input type="checkbox"/> <b>Snags and Logs:</b> Trees are considered snags if they are dead or dying and exhibit sufficient decay characteristics to enable cavity excavation/use by wildlife. Priority snags have a diameter at breast height of &gt; 51 cm (20 in) in western Washington and are &gt; 2 m (6.5 ft) in height. Priority logs are &gt; 30 cm (12 in) in diameter at the largest end, and &gt; 6 m (20 ft) long.</p> <p>If wetland has <b>3 or more</b> priority habitats = <b>4 points</b>  <b>If wetland has 2</b> priority habitats = <b>3 points</b>                  If wetland has <b>1</b> priority habitat = <b>1 point</b>                      No habitats = 0 points</p> <p>Note: All vegetated wetlands are by definition a priority habitat but are not included in this list. Nearby wetlands are addressed in question H 2.4)</p>	3
	<p>H 2.4 <u>Wetland Landscape:</u> Choose the <b>one</b> description of the landscape around the wetland that best fits (see p. 84)</p> <ul style="list-style-type: none"> <li>• There are at least 3 other wetlands within 1/2 mile, and the connections between them are relatively undisturbed (light grazing between wetlands OK, as is lake shore with some boating, but connections should NOT be bisected by paved roads, fill, fields, or other development.....points = 5</li> <li>• The wetland is Lake-fringe on a lake with little disturbance and there are 3 other lake-fringe wetlands within 1/2 mile .....points = 5</li> <li>• <b>There are at least 3 other wetlands within 1/2 mile, BUT the connections between them are disturbed.....points = 3</b></li> <li>• The wetland fringe on a lake <b>with</b> disturbance and there are 3 other lake-fringe wetlands within 1/2 mile .....points = 3</li> <li>• There is at least 1 wetland within 1/2 mile .....points = 2</li> <li>• There are no wetlands within 1/2 mile.....points = 0</li> </ul>	3
<p><b>H 2 TOTAL Score</b> – opportunity for providing habitat      Add the scores from H2.1, H2.2, H2.3, H2.4</p>		8
<p>TOTAL for H 1 from page 8</p>		6
◆	<p><b>Total Score for Habitat Functions</b>                      Add the points for H 1 and H 2; then <b>record the result on p. 1</b></p>	14

Comments:





SC4	<p><b>Forested Wetlands</b> (see p. 90)</p> <p>Does the wetland have at least 1 acre of forest that meet one of these criteria for the Department of Fish and Wildlife's forests as priority habitats? <i>If you answer yes you will still need to rate the wetland based on its function.</i></p> <p>___ <b>Old-growth forests:</b> (west of Cascade Crest) Stands of at least two three species forming a multi-layered canopy with occasional small openings; with at least 8 trees/acre (20 trees/hectare) that are at least 200 years of age OR have a diameter at breast height (dbh) of 32 inches (81 cm or more).</p> <p>NOTE: The criterion for dbh is based on measurements for upland forests. Two-hundred year old trees in wetlands will often have a smaller dbh because their growth rates are often slower. The DFW criterion is and "OR" so old-growth forests do not necessarily have to have trees of this diameter.</p> <p>___ <b>Mature forests:</b> (west of the Cascade Crest) Stands where the largest trees are 80 – 200 years old OR have an average diameters (dbh) exceeding 21 inches (53 cm); crown cover may be less than 100%; decay, decadence, numbers of snags, and quantity of large downed material is generally less than that found in old-growth.</p> <p>YES = Category I                      NO = <u>X</u> not a forested wetland with special characteristics</p>	Cat. I
SC5	<p><b>Wetlands in Coastal Lagoons</b> (see p. 91)</p> <p>Does the wetland meet all of the following criteria of a wetland in a coastal lagoon?</p> <p>___ The wetland lies in a depression adjacent to marine waters that is wholly or partially separated from marine waters by sandbanks, gravel banks, shingle, or, less frequently, rocks.</p> <p>___ The lagoon in which the wetland is located contains surface water that is saline or brackish (&gt; 0.5 ppt) during most of the year in at least a portion of the lagoon (<i>needs to be measured near the bottom.</i>)</p> <p>YES = Go to SC 5.1                      NO <u>X</u> not a wetland in a coastal lagoon</p> <p>SC 5.1 Does the wetland meet all of the following three conditions?</p> <p>___ The wetland is relatively undisturbed (has no diking, ditching, filling, cultivation, grazing) and has less than 20% cover of invasive plant species (see list of invasive species on p. 74).</p> <p>___ At least 3/4 of the landward edge of the wetland has a 100 ft. buffer of shrub, forest, or un-grazed or un-mowed grassland.</p> <p>___ The wetland is larger than 1/10 acre (4350 square ft.)</p> <p>YES = Category I                      NO = Category II</p>	Cat. I Cat. II
SC6	<p><b>Interdunal Wetlands</b> (see p. 93)</p> <p>Is the wetland west of the 1889 line (also called the Western Boundary of Upland Ownership or WBUO)?</p> <p>YES = Go to SC 6.1                      NO <u>X</u> not an interdunal wetland for rating</p> <p><i>If you answer yes you will still need to rate the wetland based on its functions.</i></p> <p>In practical terms that means the following geographic areas:</p> <ul style="list-style-type: none"> <li>• Long Beach Peninsula -- lands west of SR 103</li> <li>• Grayland-Westport -- lands west of SR 105</li> <li>• Ocean Shores-Copalis – lands west of SR 115 and SR 109</li> </ul> <p>SC 6.1 Is the wetland one acre or larger, or is it in a mosaic of wetlands that is one acre or larger?</p> <p>YES = Category II                      NO = go to SC 6.2</p> <p>SC 6.2 Is the wetland between 0.1 and 1 acre, or is it in a mosaic of wetlands that is between 0.1 and 1 acre?</p> <p>YES = Category III</p>	Cat. II Cat. III
◆	<p><b>Category of wetland based on Special Characteristics</b></p> <p>Choose the "highest" rating if wetland falls into several categories, and record on p. 1.</p> <p>If you answered NO for all types enter "Not Applicable" on p. 1</p>	NA

Comments:

Wetland name or number 24A

**WETLAND RATING FORM – WESTERN WASHINGTON**  
Version 2 – Updated July 2006 to increase accuracy and reproducibility among users  
Updated Oct. 2008 with the new WDFW definitions for priority habitats

Name of wetland (if known): 24A Date of site visit: 09-20-13

Rated by: Colin Worsley / Matt Maynard Trained by Ecology? Yes  No  Date of training: 11-2005 / 04-2006

SEC: 06 TOWNSHIP: 24N RANGE: 06E Is S/T/R in Appendix D? Yes  No

Map of wetland unit: Figure \_\_\_\_\_ Estimated size 0.60 acre

**SUMMARY OF RATING**

Category based on FUNCTIONS provided by wetland: I \_\_\_\_\_ II \_\_\_\_\_ III X IV \_\_\_\_\_

Category I =	Score > 70
Category II =	Score 51 - 69
Category III =	Score 30 – 50
Category IV =	Score < 30

Score for Water Quality Functions	12
Score for Hydrologic Functions	12
Score for Habitat Functions	18
<b>TOTAL Score for Functions</b>	<b>42</b>

Category based on SPECIAL CHARACTERISTICS of Wetland I \_\_\_\_\_ II \_\_\_\_\_ Does not apply X

**Final Category** (choose the “highest” category from above”) **III**

**Summary of basic information about the wetland unit.**

Wetland Unit has Special Characteristics		Wetland HGM Class used for Rating	
<b>Estuarine</b>		<b>Depressional</b>	<b>X</b>
<b>Natural Heritage Wetland</b>		<b>Riverine</b>	<b>(x)</b>
<b>Bog</b>		<b>Lake-fringe</b>	
<b>Mature Forest</b>		<b>Slope</b>	
<b>Old Growth Forest</b>		<b>Flats</b>	
<b>Coastal Lagoon</b>		<b>Freshwater Tidal</b>	
<b>Interdunal</b>			
None of the above	X	Check if unit has multiple HGM classes present	<b>X</b>

**Does the wetland being rated meet any of the criteria below?** If you answer YES to any of the questions below you will need to protect the wetland according to the regulations regarding the special characteristics found in the wetland.

Check List for Wetlands that Need Additional Protection (in addition to the protection recommended for its category)	YES	NO
SP1. <i>Has the wetland unit been documented as a habitat for any Federally listed Threatened or Endangered <b>animal or plant</b> species (T/E species)?</i> For the purposes of this rating system, “documented” means the wetland is on the appropriate state or federal database.		X
SP2. <i>Has the wetland unit been documented as habitat for any State listed Threatened or Endangered <b>animal</b> species?</i> For the purposes of this rating system, “documented” means the wetland is on the appropriate state database. Note: Wetlands with State listed plant species are categorized as Category 1 Natural Heritage Wetlands (see p. 19 of data form).		X
SP3. <i>Does the wetland unit contain individuals of Priority species listed by the WDFW for the state?</i>		X
SP4. <i>Does the wetland unit have a local significance in addition to its functions?</i> For example, the wetland has been identified in the Shoreline Master Program, the Critical Areas Ordinance, or in a local management plan as having special significance.		X

To complete the next part of the data sheet you will need to determine the Hydrogeomorphic Class of the wetland being rated.

Exhibit 16  
SSDP2016-00415  
001110

### Classification of Vegetated Wetlands for Western Washington

If the hydrologic criteria listed in each question do not apply to the entire unit being rated, you probably have a unit with multiple HGM classes. In this case, identify which hydrologic criteria in questions 1-7 apply, and go to Question 8.

1. Are the water levels in the entire unit usually controlled by tides (i.e. except during floods)?  
**NO – go to 2**                      **YES – the wetland class is Tidal Fringe**  
 If yes, is the salinity of the water during periods of annual low flow below 0.5 ppt (parts per thousand)?  
**YES – Freshwater Tidal Fringe**                      **NO – Saltwater Tidal Fringe (Estuarine)**  
*If your wetland can be classified as a Freshwater Tidal Fringe use the forms for Riverine wetlands. If it is a Saltwater Tidal Fringe it is rated as an Estuarine wetland. Wetlands that were call estuarine in the first and second editions of the rating system are called Salt Water Tidal Fringe in the Hydrogeomorphic Classification. Estuarine wetlands were categorized separately in the earlier editions, and this separation is being kept in this revision. To maintain consistency between editions, the term “Estuarine” wetland is kept. Please note, however, that the characteristics that define Category I and II estuarine wetlands have changed (see p. \_\_\_\_).*

---

2. The entire wetland unit is flat and precipitation is only source (>90%) of water to it. Groundwater and surface water runoff are NOT sources of water to the unit.  
**NO – go to 3**                      **YES – The wetland class is Flats**  
 If your wetland can be classified as a “Flats” wetland, use the form for **Depressional** wetlands.

---

3. Does the entire wetland meet both of the following criteria?  
 \_\_\_\_\_ The vegetated part of the wetland is on the shores of a body of permanent open water (without any vegetation on the surface) where at least 20 acres (8ha) in size;  
 \_\_\_\_\_ At least 30% of the open water area is deeper than 6.6 (2 m)?  
**NO – go to 4**                      **YES – The wetland class is Lake-fringe (Lacustrine Fringe)**

---

4. Does the entire wetland meet all of the following criteria?  
 \_\_\_\_\_ The wetland is on a slope (*slope can be very gradual*).  
 \_\_\_\_\_ The water flows through the wetland in one direction (unidirectional) and usually comes from seeps. It may flow subsurface, as sheetflow, or in a swale without distinct banks.  
 \_\_\_\_\_ The water leaves the wetland **without being impounded**?  
*NOTE: Surface water does not pond in these types of wetlands except occasionally in very small and shallow depressions or behind hummocks (depressions are usually <3 ft diameter and less than 1 foot deep).*  
**NO – go to 5**                      **YES – The wetland class is Slope**

---

5. Does the entire wetland meet all of the following criteria?  
 \_\_\_\_\_ The unit is in a valley or stream channel where it gets inundated by overbank flooding from that stream or river.  
 \_\_\_\_\_ The overbank flooding occurs at least once every two years.  
*NOTE: The riverine unit can contain depressions that are filled with water when the river is not flooding..*  
**NO – go to 6**                      **YES – The wetland class is Riverine**

---

6. Is the entire wetland unit in a topographic depression in which water ponds, or is saturated to the surface, at some time of the year. This means that any outlet, if present is higher than the interior of the wetland.  
**NO – go to 7**                      **YES – The wetland class is Depressional**

---

7. Is the entire wetland located in a very flat area with no obvious depression and no overbank flooding. The unit does not pond surface water more than a few inches. The unit seems to be maintained by high groundwater in the area. The wetland may be ditched, but has no obvious natural outlet.  
**No – go to 8**                      **YES – The wetland class is Depressional**

---

8. Your wetland unit seems to be difficult to classify and probably contains several different HGM classes. For example, seeps at the base of a slope may grade into a riverine floodplain, or a small stream within a depressional wetland has a zone of flooding along its sides. **GO BACK AND IDENTIFY WHICH OF THE HYDROLOGIC REGIMES DESCRIBED IN QUESTIONS 1-7 APPLY TO DIFFERENT AREAS IN THE UNIT** (make a rough sketch to help you decide). Use the following table to identify the appropriate class to use for the rating system if you have several HGM classes present within your wetland. *NOTE: Use this table only if the class that is recommended in the second column represents 10% or more of the total area of the wetland unit being rated. If the area of the class listed in column 2 is less than 10% of the unit, classify the wetland using the class that represents more than 90% of the total area.*

<i>HGM Classes within the wetland unit being rated</i>	<i>HGM Class to Use in Rating</i>
Slope + Riverine	Riverine
Slope + Depressional	Depressional
Slope + Lake-fringe	Lake-fringe
Depressional + Riverine along stream within boundary	Depressional
Depressional + Lake-fringe	Depressional
Salt Water Tidal Fringe and any other class of freshwater wetland	Treat as ESTUARINE under wetlands with special characteristics

If you are unable still to determine which of the above criteria apply to your wetland, or you have more than 2 HGM classes within a wetland boundary, classify the wetland as **Depressional** for the rating.

Exhibit 16  
SSDP2016-00415  
001111

D Depressional and Flat Wetlands		Points
WATER QUALITY FUNCTIONS – Indicators that wetland functions to improve water quality.		(only 1 score per box) (see p.38)
<b>D 1</b>	<b>Does the wetland have the <u>potential</u> to improve water quality?</b>	
D 1.1	Characteristics of surface water flows out of the wetland: <ul style="list-style-type: none"> <li>Unit is a depression with no surface water leaving it (no outlet)..... points = 3</li> <li>Unit has an intermittently flowing, OR highly constricted, permanently flowing outlet ..... points = 2</li> <li><b>Unit has an unconstricted, or slightly constricted, surface outlet (permanently flowing) ..... points = 1</b></li> <li>Unit is a “flat” depression (Q.7 on key), or in the Flats class, with permanent surface outflow <b>and no obvious natural outlet</b> and/or outlet is a man-made ditch..... points = 1 <i>(If ditch is not permanently flowing treat unit as “intermittently flowing”)</i> <b>Provide photo or drawing</b></li> </ul>	<b>Figure</b> ___  1
D 1.2	The soil 2 inches below the surface (or duff layer) is clay or organic ( <i>use NRCS definitions</i> ) YES points = 4 <b>NO points = 0</b>	0
D 1.3	Characteristics of persistent vegetation (emergent, shrub, and/or forest Cowardin class): <ul style="list-style-type: none"> <li><b>Wetland has persistent, ungrazed vegetation &gt; = 95% of area..... points = 5</b></li> <li>Wetland has persistent, ungrazed vegetation &gt; = 1/2 of area..... points = 3</li> <li>Wetland has persistent, ungrazed vegetation &gt; = 1/10 of area..... points = 1</li> <li>Wetland has persistent, ungrazed vegetation &lt; 1/10 of area..... points = 0</li> </ul> <b>Map of Cowardin vegetation classes</b>	<b>Figure</b> ___  5
D 1.4	Characteristics of seasonal ponding or inundation: <i>This is the area of the wetland that is ponded for at least 2 months, but dries out sometime during the year. Do not count the area that is permanently ponded. Estimate area as the average condition 5 out of 10 years.</i> <ul style="list-style-type: none"> <li>Area seasonally ponded is &gt; 1/2 total area of wetland ..... points = 4</li> <li>Area seasonally ponded is &gt; 1/4 total area of wetland ..... points = 2</li> <li><b>Area seasonally ponded is &lt; 1/4 total area of wetland ..... points = 0</b></li> </ul> <b>Map of Hydroperiods</b>	<b>Figure</b> ___  0
<b>Total for D 1</b>		Add the points in the boxes above
		6
<b>D 2</b>	<b>Does the wetland have the <u>opportunity</u> to improve water quality?</b> Answer YES if you know or believe there are pollutants in groundwater or surface water coming into the wetland that would otherwise reduce water quality in streams, lakes or groundwater downgradient from the wetland? <i>Note which of the following conditions provide the sources of pollutants. A unit may have pollutants coming from several sources, but any single source would qualify as opportunity.</i> ___ Grazing in the wetland or within 150 ft ___ Untreated stormwater discharges to wetland ___ Tilled fields or orchards within 150 ft. of wetland ___ A stream or culvert discharges into wetland that drains developed areas, residential areas, farmed fields, roads, or clear-cut logging <u>X</u> Residential, urban areas, golf courses are within 150 ft. of wetland ___ Wetland is fed by groundwater high in phosphorus or nitrogen ___ Other _____ YES multiplier is 2          NO multiplier is 1	(see p. 44)      Multiplier  <u>X2</u>
<b>◆ TOTAL – Water Quality Functions</b> Multiply the score from D1 by D2; then <b>add score to table on p. 1</b>		12
HYDROLOGIC FUNCTIONS – Indicators that wetland unit functions to reduce flooding and stream degradation.		(see p.46)
<b>D 3</b>	<b>Does the wetland have the <u>potential</u> to reduce flooding and erosion?</b>	
D 3.1	Characteristics of surface water flows out of the wetland unit <ul style="list-style-type: none"> <li>Unit is a depression with no surface water leaving it (no outlet)..... points = 4</li> <li>Unit has an intermittently flowing, OR highly constricted permanently flowing outlet ..... points = 2</li> <li>Unit is a “flat” depression (Q.7 on key) or in the Flats class, with permanent surface outflow <b>and no obvious natural outlet</b> and/or outlet is a man-made ditch..... points = 1 <i>(If ditch is not permanently flowing treat unit as “intermittently flowing”)</i></li> <li><b>Unit has an unconstricted, or slightly constricted, surface outlet (permanently flowing) ..... points = 0</b></li> </ul>	0
D 3.2	Depth of storage during wet periods. <i>Estimate the height of ponding above the bottom of the outlet. For units with no outlet measure from the surface of permanent water or deepest part (if dry).</i> <ul style="list-style-type: none"> <li>Marks of ponding are 3 ft. or more above the surface or bottom of the outlet ..... points = 7</li> <li>The wetland is a “headwater” wetland..... points = 5</li> <li>Marks of ponding between 2 ft. to &lt; 3 ft. from surface or bottom of outlet ..... points = 5</li> <li><b>Marks are at least 0.5 ft. to &lt; 2 ft. from surface or bottom of outlet..... points = 3</b></li> <li>Wetland is flat (yes to Q.2 or Q.7)but has small depressions on the surface that trap water points = 1</li> <li>Marks of ponding less than 0.5 ft ..... points = 0</li> </ul>	3
D 3.3	Contribution of wetland unit to storage in the watershed: <i>Estimate the ratio of the area of upstream basin contributing surface water to the wetland to the area of the wetland unit itself.</i> <ul style="list-style-type: none"> <li>The area of the basin is less than 10 times the area of unit..... points = 5</li> <li><b>The area of the basin is 10 to 100 times the area of the unit ..... points = 3</b></li> <li>The area of the basin is more than 100 times the area of the unit ..... points = 0</li> <li>Entire unit is in the FLATS class ..... points = 5</li> </ul>	3
<b>Total for D 3</b>		Add the points in the boxes above
		6

<b>D 4</b>	<p><b>Does the wetland have the <u>opportunity</u> to reduce flooding and erosion?</b></p> <p>Answer YES if the unit is in a location in the watershed where the flood storage, or reduction in water velocity, it provides helps protect downstream property and aquatic resources from flooding or excessive and/or erosive flows. Answer NO if the water coming into the wetland is controlled by a structure such as flood gate, tide gate, flap valve, reservoir etc. OR you estimate that more than 90% of the water in the wetland is from groundwater in areas where damaging groundwater flooding does not occur. <i>Note which of the following indicators of opportunity apply.</i></p> <p><input type="checkbox"/> Wetland is in a headwater of a river or stream that has flooding problems.</p> <p><input checked="" type="checkbox"/> Wetland drains to a river or stream that has flooding problems</p> <p><input type="checkbox"/> Wetland has no outlet and impounds surface runoff water that might otherwise flow into a river or stream that has flooding problems</p> <p><input type="checkbox"/> Other _____</p> <p><b>YES multiplier is 2</b>                      NO multiplier is 1</p>	<p>(see p. 49)</p> <p>Multiplier</p> <p><u>X2</u></p>
◆	<p><b>TOTAL – Hydrologic Functions</b>                      Multiply the score from D3 by D4; then <i>add score to table on p. 1</i></p>	<p>12</p>

Comments:





<p><i>These questions apply to wetlands of all HGM classes.</i></p> <p>HABITAT FUNCTIONS – Indicators that wetland functions to provide important habitat.</p>		<p><b>Points</b> (only 1 score per box)</p>
<b>H 1</b>	<b>Does the wetland have the <u>potential</u> to provide habitat for many species?</b>	
	<p>H 1.1 <u>Vegetation structure</u> (see P. 72):                      Check the types of vegetation classes present (as defined by Cowardin) – Size threshold for each class is 1/4 acre or more than 10% of the area if unit is smaller than 2.5 acres.</p> <p><input type="checkbox"/> Aquatic Bed  <input checked="" type="checkbox"/> Emergent plants  <input checked="" type="checkbox"/> Scrub/shrub (areas where shrubs have &gt; 30% cover)  <input checked="" type="checkbox"/> Forested (areas where trees have &gt; 30% cover)                      If the unit has a forested class check if:  <input checked="" type="checkbox"/> The forested class has 3 out of 5 strata (canopy, sub-canopy, shrubs, herbaceous, moss/ground-cover) that each cover 20% within the forested polygon.                      Add the number of vegetation types that qualify. If you have:</p> <p style="text-align: right;"> <b>Map of Cowardin vegetation classes</b>                      3 structures ..... points = 2                      1 structure ..... points = 0                 </p> <p style="text-align: center;"> <span style="background-color: yellow;">4 structures or more ..... points = 4</span>                      2 structures ..... points = 1                 </p>	<p><b>Figure</b> ____</p> <p style="text-align: right;">4</p>
	<p>H 1.2 <u>Hydroperiods</u> (see p.73):                      Check the types of water regimes (hydroperiods) present within the wetland. The water regime has to cover more than 10% of the wetland or 1/4 acre to count (see text for descriptions of hydroperiods).</p> <p><input type="checkbox"/> Permanently flooded or inundated  <input type="checkbox"/> Seasonally flooded or inundated  <input checked="" type="checkbox"/> Occasionally flooded or inundated  <input checked="" type="checkbox"/> Saturated only  <input checked="" type="checkbox"/> Permanently flowing stream or river in, or adjacent to, the wetland  <input type="checkbox"/> Seasonally flowing stream in, or adjacent to, the wetland  <input type="checkbox"/> <b>Lake-fringe wetland..... = 2 points</b>  <input type="checkbox"/> <b>Freshwater tidal wetland ..... = 2 points</b></p> <p style="text-align: right;"> <b>Map of hydroperiods</b>                      4 or more types present points = 3  <span style="background-color: yellow;">3 or more types present ..... points = 2</span>                      2 types present ..... points = 1                      1 type present ..... points = 0                 </p>	<p><b>Figure</b> ____</p> <p style="text-align: right;">2</p>
	<p>H 1.3 <u>Richness of Plant Species</u> (see p. 75):                      Count the number of plant species in the wetland that cover at least 10 ft<sup>2</sup> (different patches of the same species can be combined to meet the size threshold)                      You do not have to name the species. Do not include Eurasian Milfoil, reed canarygrass, purple loosestrife, Canadian Thistle.                      If you counted: &gt; 19 species ..... points = 2  <span style="background-color: yellow;">5 – 19 species ..... points = 1</span>                      &lt; 5 species ..... points = 0</p> <p>List species below if you want to:</p> <p>_____</p> <p>_____</p> <p>_____</p>	<p style="text-align: right;">1</p>
	<p>H 1.4 <u>Interspersion of Habitats</u> (see p. 76):                      Decided from the diagrams below whether interspersion between Cowardin vegetation (described in H1.1), or the classes and unvegetated areas (can include open water or mudflats) is high, medium, low, or none.</p> <div style="display: flex; justify-content: space-around;"> <div style="text-align: center;">  <p>None = 0 points</p> </div> <div style="text-align: center;">  <p>Low = 1 point</p> </div> <div style="text-align: center;">  <p>Moderate = 2 points</p> </div> </div> <div style="display: flex; justify-content: space-around; margin-top: 20px;"> <div style="text-align: center;">  <p>High = 3 points</p> </div> <div style="text-align: center;">  <p>High = 3 points</p> </div> <div style="text-align: center;">  <p>[riparian braided channels]</p> </div> </div> <p style="text-align: right; margin-top: 20px;"> <b>Note:</b> If you have 4 or more classes or 3 vegetation classes and open water, the rating is always “high”.   <b>Use map of Cowardin classes.</b> </p>	<p><b>Figure</b> ____</p> <p style="text-align: right;">2</p>
	<p>H 1.5 <u>Special Habitat Features</u> (see p. 77):                      Check the habitat features that are present in the wetland. The number of checks is the number of points you put into the next column.</p> <p><input type="checkbox"/> Large, downed, woody debris within the wetland (&gt; 4 in. diameter and 6 ft. long)  <input checked="" type="checkbox"/> Standing snags (diameter at the bottom &gt; 4 inches) in the wetland  <input type="checkbox"/> Undercut banks are present for at least 6.6 ft. (2m) and/or overhanging vegetation extends at least 3.3 ft. (1m) over a stream (or ditch) in, or contiguous with the unit, for at least 33 ft. (10m)  <input type="checkbox"/> Stable steep banks of fine material that might be used by beaver or muskrat for denning (&gt; 30 degree slope) OR signs of recent beaver activity are present (cut shrubs or trees that have not yet turned grey/brown)  <input type="checkbox"/> At least 1/4 acre of thin-stemmed persistent vegetation or woody branches are present in areas that are permanently or seasonally inundated (structures for egg-laying by amphibians)  <input type="checkbox"/> Invasive plants cover less than 25% of the wetland area in each stratum of plants</p> <p><i>NOTE: The 20% stated in early printings of the manual on page 78 is an error.</i></p>	<p style="text-align: right;">1</p>
<p><b>H 1 TOTAL Score</b> – potential for providing habitat</p>		<p>Add the points in the column</p> <p style="text-align: right;"><b>10</b></p>

Exhibit 16  
SSDP2016-00415  
001114

H 2	Does the wetland have the <u>opportunity</u> to provide habitat for many species?	(only 1 score per box)
	<p>H 2.1 <b>Buffers</b> (see P. 80):  <i>Choose the description that best represents condition of buffer of wetland unit. The highest scoring criterion that applies to the wetland is to be used in the rating. See text for definition of "undisturbed".</i></p> <p><input type="checkbox"/> 100m (330 ft) of relatively undisturbed vegetated areas, rocky areas, or open water &gt; 95% of circumference. No structures are within the undisturbed part of buffer (relatively undisturbed also means no grazing, no landscaping, no daily human use)..... <b>points = 5</b></p> <p><input type="checkbox"/> 100m (330 ft) of relatively undisturbed vegetated areas, rocky areas, or open water &gt; 50% circumference ..... <b>points = 4</b></p> <p><input type="checkbox"/> 50m (170 ft) of relatively undisturbed vegetated areas, rocky areas, or open water &gt; 95% circumference ..... <b>points = 4</b></p> <p><input type="checkbox"/> 100m (330 ft) of relatively undisturbed vegetated areas, rocky areas, or open water &gt; 25% circumference ..... <b>points = 3</b></p> <p><input type="checkbox"/> 50m (170 ft) of relatively undisturbed vegetated areas, rocky areas, or open water for &gt; 50% circumference ..... <b>points = 3</b></p> <p><b>If buffer does not meet any of the criteria above:</b></p> <p><input type="checkbox"/> No paved areas (except paved trails) or buildings within 25m (80 ft) of wetland &gt; 95% circumference. Light to moderate grazing or lawns are OK ..... <b>points = 2</b></p> <p><input type="checkbox"/> No paved areas of buildings within 50m of wetland for &gt; 50% circumference. Light to moderate grazing or lawns are OK..... <b>points = 2</b></p> <p><input type="checkbox"/> Heavy grazing in buffer ..... <b>points = 1</b></p> <p><input type="checkbox"/> Vegetated buffers are &lt; 2m wide (6.6 ft) for more than 95% circumference (e.g. tilled fields, paving, basalt bedrock extend to edge of wetland) ..... <b>points = 0</b></p> <p><input checked="" type="checkbox"/> Buffer does not meet any of the criteria above ..... <b>points = 1</b></p> <p style="text-align: right;"><b>Arial photo showing buffers</b></p>	<p><b>Figure</b> _____</p> <p>1</p>
	<p>H 2.2 <b>Corridors and Connections</b> (see p. 81)</p> <p>H 2.2.1 Is the wetland part of a relatively undisturbed and unbroken vegetated corridor (either riparian or upland) that is at least 150 ft. wide, has at least a 30% cover of shrubs, forest or native undisturbed prairie, that connects to estuaries, other wetlands or undisturbed uplands that are at least 250 acres in size? (<i>Dams in riparian corridors, heavily used gravel roads, paved roads, are considered breaks in the corridor.</i>)                  YES = <b>4 points</b> (go to H 2.3) <span style="background-color: yellow;">NO = go to H 2.2.2</span></p> <p>H. 2.2.2 Is the wetland part of a relatively undisturbed and unbroken vegetated corridor (either riparian or upland) that is at least 50 ft. wide, has at least 30% cover of shrubs or forest, and connects to estuaries, other wetlands or undisturbed uplands that are at least 25 acres in size? <b>OR a Lake-fringe</b> wetland, if it does not have an undisturbed corridor as in the question above?                  YES = <b>2 points</b> (go to H 2.3) <span style="background-color: yellow;">NO = go to H 2.2.3</span></p> <p>H. 2.2.3 Is the wetland:                  • Within 5 mi (8km) of a brackish or salt water estuary OR                  • Within 3 miles of a large field or pasture (&gt; 40 acres) OR <span style="background-color: yellow;">YES = 1 point</span>                  • <span style="background-color: yellow;">Within 1 mile of a lake greater than 20 acres?</span> <span style="background-color: yellow;">NO = 0 points</span></p>	<p>1</p>

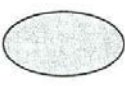
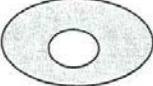
Comments:

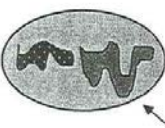

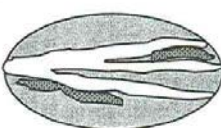
	<p>H 2.3 <u>Near or adjacent to other priority habitats listed by WDFW</u> (see p. 82): (see new and complete descriptions of WDFW priority habitats, and the counties in which they can be found, in the PHS report <a href="http://wdfw.wa.gov/hab/phslist.htm">http://wdfw.wa.gov/hab/phslist.htm</a>)</p> <p>Which of the following priority habitats are within 330 ft. (100m) of the wetland unit?  <i>NOTE: the connections do not have to be relatively undisturbed.</i></p> <p><input type="checkbox"/> <b>Aspen Stands:</b> Pure or mixed stands of aspen greater than 0.4 ha (1 acre).</p> <p><input type="checkbox"/> <b>Biodiversity Areas and Corridors:</b> Areas of habitat that are relatively important to various species of native fish and wildlife (full descriptions in WDFW PHS report p. 152).</p> <p><input type="checkbox"/> <b>Herbaceous Balds:</b> Variable size patches of grass and forbs on shallow soils over bedrock.</p> <p><input type="checkbox"/> <b>Old-growth/Mature forests:</b> (Old-growth west of Cascade crest) Stands of at least 2 tree species, forming a multi-layered canopy with occasional small openings; with at least 20 trees/ha (8 trees/acre) &gt; 81 cm (32 in) dbh or &gt; 200 years of age. (Mature forests) Stands with average diameters exceeding 53 cm (21 in) dbh; crown cover may be less than 100%; decay, decadence, numbers of snags, and quantity of large downed material is generally less than that found in old-growth; 80 - 200 years old west of the Cascade crest.</p> <p><input type="checkbox"/> <b>Oregon white Oak:</b> Woodlands Stands of pure oak or oak/conifer associations where canopy coverage of the oak component is important (full descriptions in WDFW PHS report p. 158).</p> <p><input checked="" type="checkbox"/> <b>Riparian:</b> The area adjacent to aquatic systems with flowing water that contains elements of both aquatic and terrestrial ecosystems which mutually influence each other.</p> <p><input type="checkbox"/> <b>Westside Prairies:</b> Herbaceous, non-forested plant communities that can either take the form of a dry prairie or a wet prairie (full descriptions in WDFW PHS report p. 161).</p> <p><input checked="" type="checkbox"/> <b>Instream:</b> The combination of physical, biological, and chemical processes and conditions that interact to provide functional life history requirements for instream fish and wildlife resources.</p> <p><input type="checkbox"/> <b>Nearshore:</b> Relatively undisturbed nearshore habitats. These include Coastal Nearshore, Open Coast Nearshore, and Puget Sound Nearshore. (full descriptions of habitats and the definition of relatively undisturbed are in WDFW report: pp. 167-169 and glossary in Appendix A).</p> <p><input type="checkbox"/> <b>Caves:</b> A naturally occurring cavity, recess, void, or system of interconnected passages under the earth in soils, rock, ice, or other geological formations and is large enough to contain a human.</p> <p><input type="checkbox"/> <b>Cliffs:</b> Greater than 7.6 m (25 ft) high and occurring below 5000 ft.</p> <p><input type="checkbox"/> <b>Talus:</b> Homogenous areas of rock rubble ranging in average size 0.15 - 2.0 m (0.5 - 6.5 ft), composed of basalt, andesite, and/or sedimentary rock, including riprap slides and mine tailings. May be associated with cliffs.</p> <p><input type="checkbox"/> <b>Snags and Logs:</b> Trees are considered snags if they are dead or dying and exhibit sufficient decay characteristics to enable cavity excavation/use by wildlife. Priority snags have a diameter at breast height of &gt; 51 cm (20 in) in western Washington and are &gt; 2 m (6.5 ft) in height. Priority logs are &gt; 30 cm (12 in) in diameter at the largest end, and &gt; 6 m (20 ft) long.</p> <p>If wetland has <b>3 or more</b> priority habitats = <b>4 points</b>  <b>If wetland has 2</b> priority habitats = <b>3 points</b>                  If wetland has <b>1</b> priority habitat = <b>1 point</b>                      No habitats = 0 points</p> <p>Note: All vegetated wetlands are by definition a priority habitat but are not included in this list. Nearby wetlands are addressed in question H 2.4)</p>	3
	<p>H 2.4 <u>Wetland Landscape:</u> Choose the <b>one</b> description of the landscape around the wetland that best fits (see p. 84)</p> <ul style="list-style-type: none"> <li>• There are at least 3 other wetlands within 1/2 mile, and the connections between them are relatively undisturbed (light grazing between wetlands OK, as is lake shore with some boating, but connections should NOT be bisected by paved roads, fill, fields, or other development.....points = 5</li> <li>• The wetland is Lake-fringe on a lake with little disturbance and there are 3 other lake-fringe wetlands within 1/2 mile .....points = 5</li> <li>• <b>There are at least 3 other wetlands within 1/2 mile, BUT the connections between them are disturbed.....points = 3</b></li> <li>• The wetland fringe on a lake <b>with</b> disturbance and there are 3 other lake-fringe wetlands within 1/2 mile .....points = 3</li> <li>• There is at least 1 wetland within 1/2 mile .....points = 2</li> <li>• There are no wetlands within 1/2 mile.....points = 0</li> </ul>	3
<p><b>H 2 TOTAL Score</b> – opportunity for providing habitat      Add the scores from H2.1, H2.2, H2.3, H2.4</p>		8
<p>TOTAL for H 1 from page 8</p>		10
◆	<p><b>Total Score for Habitat Functions</b>                      Add the points for H 1 and H 2; then <b>record the result on p. 1</b></p>	18

Comments:

### CATEGORIZATION BASED ON SPECIAL CHARACTERISTICS

*Please determine if the wetland meets the attributes described below  
and circle the appropriate answers and Category.*

<b>Wetland Type</b> – Check off any criteria that apply to the wetland. Circle the Category when the appropriate criteria are met.	
<b>SC1</b>	<p><b>Estuarine wetlands?</b> (see p.86)</p> <p>Does the wetland unit meet the following criteria for Estuarine wetlands?</p> <p><input type="checkbox"/> The dominant water regime is tidal,  <input type="checkbox"/> Vegetated, and  <input type="checkbox"/> With a salinity greater than 0.5 ppt.</p> <p style="text-align: center;">YES = Go to SC 1.1                      NO <u>  X  </u></p>
	<p>SC 1.1 Is the wetland unit within a National Wildlife Refuge, National Park, National Estuary Reserve, Natural Area Preserve, State Park or Educational, Environmental, or Scientific Reserve designated under WAC 332-30-151?    YES = Category I                      NO = go to SC 1.2</p>
	<p>SC 1.2 Is the wetland at least 1 acre in size and meets at least two of the following conditions?</p> <p style="text-align: center;">YES = Category I                      NO = Category II</p> <p><input type="checkbox"/> The wetland is relatively undisturbed (has no diking, ditching, filling, cultivation, grazing, and has less than 10% cover of non-native plant species. If the non-native <i>Spartina</i> spp., are only species that cover more than 10% of the wetland, then the wetland should be given a dual rating (I/II). The area of <i>Spartina</i> would be rated a Category II while the relatively undisturbed upper marsh with native species would be a Category I. Do not, however, exclude the area of <i>Spartina</i> in determining the size threshold of 1 acre.</p> <p><input type="checkbox"/> At least 3/4 of the landward edge of the wetland has a 100 ft. buffer of shrub, forest, or un-grazed or un-mowed grassland</p> <p><input type="checkbox"/> The wetland has at least 2 of the following features: tidal channels, depressions with open water, or contiguous freshwater wetlands.</p>
	<p><b>Cat. I</b></p> <p><b>Cat. II</b></p> <p><b>Dual Rating I/II</b></p>
<b>SC2</b>	<p><b>Natural Heritage Wetlands</b> (see p. 87)</p> <p>Natural Heritage wetlands have been identified by the Washington Natural Heritage Program/DNR as either high quality undisturbed wetlands or wetlands that support state Threatened, Endangered, or Sensitive plant species.</p> <p>SC 2.1 Is the wetland being rated in a Section/Township/Range that contains a natural heritage wetland? (<i>This question is used to screen out most sites before you need to contact WNHP/DNR.</i>)  S/T/R information from Appendix D _____ or accessed from WNHP/DNR web site _____  YES _____ Contact WNHP/DNR (see p. 79) and go to SC 2.2                      NO <u>  X  </u></p> <p>SC 2.2 Has DNR identified the wetland as a high quality undisturbed wetland or as a site with state threatened or endangered plant species?  YES = Category 1                      NO _____ not a Heritage Wetland</p>
	<p><b>Cat I</b></p>
<b>SC3</b>	<p><b>Bogs</b> (see p. 87)</p> <p>Does the wetland (<b>or any part of the unit</b>) meet both the criteria for soils and vegetation in bogs? Use the key below to identify if the wetland is a bog. <i>If you answer yes you will still need to rate the wetland based on its function.</i></p> <p>1. Does the unit have organic soil horizons (i.e. layers of organic soil), either peats or mucks, that compose 16 inches or more of the first 32 inches of soil profile? (See Appendix B for a field key to identify organic soils)?    YES = go to question 3                      <b>NO = go to question 2</b></p> <p>2. Does the wetland have organic soils, either peats or mucks that are less than 16 inches deep over bedrock, or an impermeable hardpan such as clay or volcanic ash, or that are floating on a lake or pond?    YES = go to question 3                      <b>NO = is not a bog for purpose of rating</b></p> <p>3. Does the unit have more than 70% cover of mosses at ground level, AND other plants, if present, consist of the “bog” species listed in Table 3 as a significant component of the vegetation (more than 30% of the total shrub and herbaceous cover consists of species in Table 3)?  YES = Is a bog for purpose of rating                      NO = go to question 4</p> <p>NOTE: If you are uncertain about the extent of mosses in the understory you may substitute that criterion by measuring the pH of the water that seeps into a hole dug at least 16” deep. If the pH is less than 5.0 and the “bog” plant species in Table 3 are present, the wetland is a bog.</p> <p>4. Is the unit forested (&gt; 30% cover) with sitka spruce, subalpine fir, western red cedar, western hemlock, lodgepole pine, quaking aspen, Englemann’s spruce, or western white pine. WITH any of the species (or combination of species) on the bog species plant list in Table 3 as a significant component of the ground cover (&gt; 30% coverage of the total shrub/herbaceous cover)?  YES = Category I                      NO = Is not a bog for purpose of rating</p>
	<p><b>Cat. I</b></p>

**Exhibit 16**  
**SSDP2016-00415**  
**001117**

<p><b>SC4</b></p>	<p><b>Forested Wetlands</b> (see p. 90)                  Does the wetland have at least 1 acre of forest that meet one of these criteria for the Department of Fish and Wildlife's forests as priority habitats? <i>If you answer yes you will still need to rate the wetland based on its function.</i>                  ___ <b>Old-growth forests:</b> (west of Cascade Crest) Stands of at least two three species forming a multi-layered canopy with occasional small openings; with at least 8 trees/acre (20 trees/hectare) that are at least 200 years of age OR have a diameter at breast height (dbh) of 32 inches (81 cm or more).                  NOTE: The criterion for dbh is based on measurements for upland forests. Two-hundred year old trees in wetlands will often have a smaller dbh because their growth rates are often slower. The DFW criterion is and "OR" so old-growth forests do not necessarily have to have trees of this diameter.                  ___ <b>Mature forests:</b> (west of the Cascade Crest) Stands where the largest trees are 80 – 200 years old OR have an average diameters (dbh) exceeding 21 inches (53 cm); crown cover may be less than 100%; decay, decadence, numbers of snags, and quantity of large downed material is generally less than that found in old-growth.                  YES = Category I                      NO = <u>X</u> not a forested wetland with special characteristics</p>	<p><b>Cat. I</b></p>
<p><b>SC5</b></p>	<p><b>Wetlands in Coastal Lagoons</b> (see p. 91)                  Does the wetland meet all of the following criteria of a wetland in a coastal lagoon?                  ___ The wetland lies in a depression adjacent to marine waters that is wholly or partially separated from marine waters by sandbanks, gravel banks, shingle, or, less frequently, rocks.                  ___ The lagoon in which the wetland is located contains surface water that is saline or brackish (&gt; 0.5 ppt) during most of the year in at least a portion of the lagoon (<i>needs to be measured near the bottom.</i>)                  YES = Go to SC 5.1                      NO <u>X</u> not a wetland in a coastal lagoon                  SC 5.1 Does the wetland meet all of the following three conditions?                  ___ The wetland is relatively undisturbed (has no diking, ditching, filling, cultivation, grazing) and has less than 20% cover of invasive plant species (see list of invasive species on p. 74).                  ___ At least 3/4 of the landward edge of the wetland has a 100 ft. buffer of shrub, forest, or un-grazed or un-mowed grassland.                  ___ The wetland is larger than 1/10 acre (4350 square ft.)                  YES = Category I                      NO = Category II</p>	<p><b>Cat. I</b>  <b>Cat. II</b></p>
<p><b>SC6</b></p>	<p><b>Interdunal Wetlands</b> (see p. 93)                  Is the wetland west of the 1889 line (also called the Western Boundary of Upland Ownership or WBUO)?                  YES = Go to SC 6.1                      NO <u>X</u> not an interdunal wetland for rating  <i>If you answer yes you will still need to rate the wetland based on its functions.</i>                  In practical terms that means the following geographic areas:                  • Long Beach Peninsula -- lands west of SR 103                  • Grayland-Westport -- lands west of SR 105                  • Ocean Shores-Copalis – lands west of SR 115 and SR 109                  SC 6.1 Is the wetland one acre or larger, or is it in a mosaic of wetlands that is one acre or larger?                  YES = Category II                      NO = go to SC 6.2                  SC 6.2 Is the wetland between 0.1 and 1 acre, or is it in a mosaic of wetlands that is between 0.1 and 1 acre?                  YES = Category III</p>	<p><b>Cat. II</b>  <b>Cat. III</b></p>
<p>◆</p>	<p><b>Category of wetland based on Special Characteristics</b>                  Choose the "highest" rating if wetland falls into several categories, and record on p. 1.                  If you answered NO for all types enter "Not Applicable" on p. 1</p>	<p><b>NA</b></p>

Comments:

Wetland name or number 24B

**WETLAND RATING FORM – WESTERN WASHINGTON**  
Version 2 – Updated July 2006 to increase accuracy and reproducibility among users  
Updated Oct. 2008 with the new WDFW definitions for priority habitats

Name of wetland (if known): 24B Date of site visit: 09-25-13

Rated by: Colin Worsley / Matt Maynard Trained by Ecology? Yes X No      Date of training: 11-2005 / 04-2006

SEC: 06 TOWNSHIP: 24N RANGE: 06E Is S/T/R in Appendix D? Yes      No X

Map of wetland unit: Figure      Estimated size 1.75 acre

**SUMMARY OF RATING**

Category based on FUNCTIONS provided by wetland: I      II      III X IV     

Category I =	Score > 70
Category II =	Score 51 - 69
Category III =	Score 30 – 50
Category IV =	Score < 30

Score for Water Quality Functions	12
Score for Hydrologic Functions	12
Score for Habitat Functions	19
<b>TOTAL Score for Functions</b>	<b>43</b>

Category based on SPECIAL CHARACTERISTICS of Wetland I      II      Does not apply X

**Final Category** (choose the “highest” category from above”) **III**

**Summary of basic information about the wetland unit.**

Wetland Unit has Special Characteristics		Wetland HGM Class used for Rating	
<b>Estuarine</b>		<b>Depressional</b>	<b>X</b>
<b>Natural Heritage Wetland</b>		<b>Riverine</b>	<b>(x)</b>
<b>Bog</b>		<b>Lake-fringe</b>	
<b>Mature Forest</b>		<b>Slope</b>	
<b>Old Growth Forest</b>		<b>Flats</b>	
<b>Coastal Lagoon</b>		<b>Freshwater Tidal</b>	
<b>Interdunal</b>			
None of the above	X	Check if unit has multiple HGM classes present	<b>X</b>

**Does the wetland being rated meet any of the criteria below?** If you answer YES to any of the questions below you will need to protect the wetland according to the regulations regarding the special characteristics found in the wetland.

Check List for Wetlands that Need Additional Protection (in addition to the protection recommended for its category)	YES	NO
SP1. <i>Has the wetland unit been documented as a habitat for any Federally listed Threatened or Endangered <b>animal or plant</b> species (T/E species)?</i> For the purposes of this rating system, “documented” means the wetland is on the appropriate state or federal database.		X
SP2. <i>Has the wetland unit been documented as habitat for any State listed Threatened or Endangered <b>animal</b> species?</i> For the purposes of this rating system, “documented” means the wetland is on the appropriate state database. Note: Wetlands with State listed plant species are categorized as Category 1 Natural Heritage Wetlands (see p. 19 of data form).		X
SP3. <i>Does the wetland unit contain individuals of Priority species listed by the WDFW for the state?</i>		X
SP4. <i>Does the wetland unit have a local significance in addition to its functions?</i> For example, the wetland has been identified in the Shoreline Master Program, the Critical Areas Ordinance, or in a local management plan as having special significance.		X

To complete the next part of the data sheet you will need to determine the Hydrogeomorphic Class of the wetland being rated.

Exhibit 16  
SSDP2016-00415  
001119

**Classification of Vegetated Wetlands for Western Washington**

If the hydrologic criteria listed in each question do not apply to the entire unit being rated, you probably have a unit with multiple HGM classes. In this case, identify which hydrologic criteria in questions 1-7 apply, and go to Question 8.

1. Are the water levels in the entire unit usually controlled by tides (i.e. except during floods)?

**NO – go to 2**

**YES – the wetland class is Tidal Fringe**

If yes, is the salinity of the water during periods of annual low flow below 0.5 ppt (parts per thousand)?

**YES – Freshwater Tidal Fringe**

**NO – Saltwater Tidal Fringe (Estuarine)**

If your wetland can be classified as a Freshwater Tidal Fringe use the forms for **Riverine** wetlands. If it is a Saltwater Tidal Fringe it is rated as an **Estuarine** wetland. Wetlands that were call estuarine in the first and second editions of the rating system are called Salt Water Tidal Fringe in the Hydrogeomorphic Classification. Estuarine wetlands were categorized separately in the earlier editions, and this separation is being kept in this revision. To maintain consistency between editions, the term “Estuarine” wetland is kept. Please note, however, that the characteristics that define Category I and II estuarine wetlands have changed (see p. \_\_\_\_).

2. The entire wetland unit is flat and precipitation is only source (>90%) of water to it. Groundwater and surface water runoff are NOT sources of water to the unit.

**NO – go to 3**

**YES – The wetland class is Flats**

If your wetland can be classified as a “Flats” wetland, use the form for **Depressional** wetlands.

3. Does the entire wetland meet both of the following criteria?

\_\_\_\_\_ The vegetated part of the wetland is on the shores of a body of permanent open water (without any vegetation on the surface) where at least 20 acres (8ha) in size;

\_\_\_\_\_ At least 30% of the open water area is deeper than 6.6 (2 m)?

**NO – go to 4**

**YES – The wetland class is Lake-fringe (Lacustrine Fringe)**

4. Does the entire wetland meet all of the following criteria?

\_\_\_\_\_ The wetland is on a slope (*slope can be very gradual*).

\_\_\_\_\_ The water flows through the wetland in one direction (unidirectional) and usually comes from seeps. It may flow subsurface, as sheetflow, or in a swale without distinct banks.

\_\_\_\_\_ The water leaves the wetland **without being impounded**?

NOTE: *Surface water does not pond in these types of wetlands except occasionally in very small and shallow depressions or behind hummocks (depressions are usually <3 ft diameter and less than 1 foot deep).*

**NO – go to 5**

**YES – The wetland class is Slope**

5. Does the entire wetland meet all of the following criteria?

\_\_\_\_\_ The unit is in a valley or stream channel where it gets inundated by overbank flooding from that stream or river.

\_\_\_\_\_ The overbank flooding occurs at least once every two years.

NOTE: *The riverine unit can contain depressions that are filled with water when the river is not flooding..*

**NO – go to 6**

**YES – The wetland class is Riverine**

6. Is the entire wetland unit in a topographic depression in which water ponds, or is saturated to the surface, at some time of the year. This means that any outlet, if present is higher than the interior of the wetland.

**NO – go to 7**

**YES – The wetland class is Depressional**

7. Is the entire wetland located in a very flat area with no obvious depression and no overbank flooding. The unit does not pond surface water more than a few inches. The unit seems to be maintained by high groundwater in the area. The wetland may be ditched, but has no obvious natural outlet.

**No – go to 8**

**YES – The wetland class is Depressional**

8. Your wetland unit seems to be difficult to classify and probably contains several different HGM classes. For example, seeps at the base of a slope may grade into a riverine floodplain, or a small stream within a depressional wetland has a zone of flooding along its sides. GO BACK AND IDENTIFY WHICH OF THE HYDROLOGIC REGIMES DESCRIBED IN QUESTIONS 1-7 APPLY TO DIFFERENT AREAS IN THE UNIT (make a rough sketch to help you decide). Use the following table to identify the appropriate class to use for the rating system if you have several HGM classes present within your wetland. NOTE: Use this table only if the class that is recommended in the second column represents 10% or more of the total area of the wetland unit being rated. If the area of the class listed in column 2 is less than 10% of the unit, classify the wetland using the class that represents more than 90% of the total area.

HGM Classes within the wetland unit being rated	HGM Class to Use in Rating
Slope + Riverine	Riverine
Slope + Depressional	Depressional
Slope + Lake-fringe	Lake-fringe
Depressional + Riverine along stream within boundary	Depressional
Depressional + Lake-fringe	Depressional
Salt Water Tidal Fringe and any other class of freshwater wetland	Treat as ESTUARINE under wetlands with special characteristics

Exhibit 16

SSDP2016-00415

001120

If you are unable still to determine which of the above criteria apply to your wetland, or you have more than 2 HGM classes within a wetland boundary, classify the wetland as **Depressional** for the rating.

<b>D Depressional and Flat Wetlands</b>		<b>Points</b>
WATER QUALITY FUNCTIONS – Indicators that wetland functions to improve water quality.		(only 1 score per box) (see p.38)
<b>D 1</b>	<b>Does the wetland have the potential to improve water quality?</b>	
D 1.1	Characteristics of surface water flows out of the wetland: <ul style="list-style-type: none"> <li>• Unit is a depression with no surface water leaving it (no outlet)..... points = 3</li> <li>• Unit has an intermittently flowing, OR highly constricted, permanently flowing outlet ..... points = 2</li> <li>• <b>Unit has an unconstricted, or slightly constricted, surface outlet (permanently flowing) ..... points = 1</b></li> <li>• Unit is a “flat” depression (Q.7 on key), or in the Flats class, with permanent surface outflow <b>and no obvious natural outlet</b> and/or outlet is a man-made ditch..... points = 1 (If ditch is not permanently flowing treat unit as “intermittently flowing”) <b>Provide photo or drawing</b></li> </ul>	Figure ____ 1
D 1.2	The soil 2 inches below the surface (or duff layer) is clay or organic (use NRCS definitions) YES points = 4 NO points = 0	0
D 1.3	Characteristics of persistent vegetation (emergent, shrub, and/or forest Cowardin class): <ul style="list-style-type: none"> <li>• <b>Wetland has persistent, ungrazed vegetation &gt;= 95% of area..... points = 5</b></li> <li>• Wetland has persistent, ungrazed vegetation &gt;= 1/2 of area..... points = 3</li> <li>• Wetland has persistent, ungrazed vegetation &gt;= 1/10 of area..... points = 1</li> <li>• Wetland has persistent, ungrazed vegetation &lt; 1/10 of area..... points = 0</li> </ul> Map of Cowardin vegetation classes	Figure ____ 5
D 1.4	Characteristics of seasonal ponding or inundation: <i>This is the area of the wetland that is ponded for at least 2 months, but dries out sometime during the year. Do not count the area that is permanently ponded. Estimate area as the average condition 5 out of 10 years.</i> <ul style="list-style-type: none"> <li>• Area seasonally ponded is &gt; 1/2 total area of wetland ..... points = 4</li> <li>• Area seasonally ponded is &gt; 1/4 total area of wetland ..... points = 2</li> <li>• <b>Area seasonally ponded is &lt; 1/4 total area of wetland ..... points = 0</b></li> </ul> Map of Hydroperiods	Figure ____ 0
<b>Total for D 1</b>		Add the points in the boxes above <b>6</b>
<b>D 2</b>	<b>Does the wetland have the opportunity to improve water quality?</b>	(see p. 44)
Answer YES if you know or believe there are pollutants in groundwater or surface water coming into the wetland that would otherwise reduce water quality in streams, lakes or groundwater downgradient from the wetland? Note which of the following conditions provide the sources of pollutants. A unit may have pollutants coming from several sources, but any single source would qualify as opportunity. <ul style="list-style-type: none"> <li>___ Grazing in the wetland or within 150 ft</li> <li>___ Untreated stormwater discharges to wetland</li> <li>___ Tilled fields or orchards within 150 ft. of wetland</li> <li>___ A stream or culvert discharges into wetland that drains developed areas, residential areas, farmed fields, roads, or clear-cut logging</li> <li><u>X</u> Residential, urban areas, golf courses are within 150 ft. of wetland</li> <li>___ Wetland is fed by groundwater high in phosphorus or nitrogen</li> <li>___ Other _____</li> </ul> YES multiplier is 2 NO multiplier is 1		Multiplier <u>X2</u>
◆ <b>TOTAL – Water Quality Functions</b> Multiply the score from D1 by D2; then add score to table on p. 1		12
HYDROLOGIC FUNCTIONS – Indicators that wetland unit functions to reduce flooding and stream degradation.		
<b>D 3</b>	<b>Does the wetland have the potential to reduce flooding and erosion?</b>	(see p.46)
D 3.1	Characteristics of surface water flows out of the wetland unit <ul style="list-style-type: none"> <li>• Unit is a depression with no surface water leaving it (no outlet)..... points = 4</li> <li>• Unit has an intermittently flowing, OR highly constricted permanently flowing outlet ..... points = 2</li> <li>• Unit is a “flat” depression (Q.7 on key) or in the Flats class, with permanent surface outflow <b>and no obvious natural outlet</b> and/or outlet is a man-made ditch..... points = 1 (If ditch is not permanently flowing treat unit as “intermittently flowing”)</li> <li>• <b>Unit has an unconstricted, or slightly constricted, surface outlet (permanently flowing) ..... points = 0</b></li> </ul>	0
D 3.2	Depth of storage during wet periods. Estimate the height of ponding above the bottom of the outlet. For units with no outlet measure from the surface of permanent water or deepest part (if dry). <ul style="list-style-type: none"> <li>• Marks of ponding are 3 ft. or more above the surface or bottom of the outlet ..... points = 7</li> <li>• The wetland is a “headwater” wetland..... points = 5</li> <li>• Marks of ponding between 2 ft. to &lt; 3 ft. from surface or bottom of outlet ..... points = 5</li> <li>• <b>Marks are at least 0.5 ft. to &lt; 2 ft. from surface or bottom of outlet..... points = 3</b></li> <li>• Wetland is flat (yes to Q.2 or Q.7)but has small depressions on the surface that trap water points = 1</li> <li>• Marks of ponding less than 0.5 ft ..... points = 0</li> </ul>	3
D 3.3	Contribution of wetland unit to storage in the watershed: Estimate the ratio of the area of upstream basin contributing surface water to the wetland to the area of the wetland unit itself. <ul style="list-style-type: none"> <li>• The area of the basin is less than 10 times the area of unit..... points = 5</li> <li>• <b>The area of the basin is 10 to 100 times the area of the unit ..... points = 3</b></li> <li>• The area of the basin is more than 100 times the area of the unit ..... points = 0</li> <li>• Entire unit is in the FLATS class ..... points = 5</li> </ul>	3
<b>Total for D 3</b>		Add the points in the boxes above <b>6</b>

<b>D 4</b>	<p><b>Does the wetland have the <u>opportunity</u> to reduce flooding and erosion?</b></p> <p>Answer YES if the unit is in a location in the watershed where the flood storage, or reduction in water velocity, it provides helps protect downstream property and aquatic resources from flooding or excessive and/or erosive flows. Answer NO if the water coming into the wetland is controlled by a structure such as flood gate, tide gate, flap valve, reservoir etc. OR you estimate that more than 90% of the water in the wetland is from groundwater in areas where damaging groundwater flooding does not occur. <i>Note which of the following indicators of opportunity apply.</i></p> <p><input type="checkbox"/> Wetland is in a headwater of a river or stream that has flooding problems.</p> <p><input checked="" type="checkbox"/> Wetland drains to a river or stream that has flooding problems</p> <p><input type="checkbox"/> Wetland has no outlet and impounds surface runoff water that might otherwise flow into a river or stream that has flooding problems</p> <p><input type="checkbox"/> Other _____</p> <p><b>YES multiplier is 2</b>                      NO multiplier is 1</p>	<p>(see p. 49)</p> <p>Multiplier</p> <p><u>X2</u></p>
◆	<p><b>TOTAL – Hydrologic Functions</b>                      Multiply the score from D3 by D4; then <i>add score to table on p. 1</i></p>	<p>12</p>

Comments:





<p><i>These questions apply to wetlands of all HGM classes.</i></p> <p>HABITAT FUNCTIONS – Indicators that wetland functions to provide important habitat.</p>		<p><b>Points</b> (only 1 score per box)</p>
<b>H 1</b>	<b>Does the wetland have the <u>potential</u> to provide habitat for many species?</b>	
H 1.1	<p><u>Vegetation structure</u> (see P. 72):                      Check the types of vegetation classes present (as defined by Cowardin) – Size threshold for each class is 1/4 acre or more than 10% of the area if unit is smaller than 2.5 acres.</p> <p><input type="checkbox"/> Aquatic Bed  <input type="checkbox"/> Emergent plants  <input checked="" type="checkbox"/> Scrub/shrub (areas where shrubs have &gt; 30% cover)  <input checked="" type="checkbox"/> Forested (areas where trees have &gt; 30% cover)                      If the unit has a forested class check if:  <input type="checkbox"/> The forested class has 3 out of 5 strata (canopy, sub-canopy, shrubs, herbaceous, moss/ground-cover) that each cover 20% within the forested polygon.                      Add the number of vegetation types that qualify. If you have:</p> <p style="text-align: right;"> <b>Map of Cowardin vegetation classes</b>                      4 structures or more..... points = 4                      3 structures..... points = 2                      2 structures..... points = 1                      1 structure..... points = 0                 </p>	<p><b>Figure</b> ____</p> <p style="text-align: right;">1</p>
H 1.2	<p><u>Hydroperiods</u> (see p.73):                      Check the types of water regimes (hydroperiods) present within the wetland. The water regime has to cover more than 10% of the wetland or 1/4 acre to count (see text for descriptions of hydroperiods).</p> <p><input checked="" type="checkbox"/> Permanently flooded or inundated  <input type="checkbox"/> Seasonally flooded or inundated  <input checked="" type="checkbox"/> Occasionally flooded or inundated  <input checked="" type="checkbox"/> Saturated only  <input checked="" type="checkbox"/> Permanently flowing stream or river in, or adjacent to, the wetland  <input type="checkbox"/> Seasonally flowing stream in, or adjacent to, the wetland  <input type="checkbox"/> <b>Lake-fringe wetland..... = 2 points</b>  <input type="checkbox"/> <b>Freshwater tidal wetland..... = 2 points</b></p> <p style="text-align: right;"> <b>Map of hydroperiods</b>                      4 or more types present points = 3                      3 or more types present..... points = 2                      2 types present..... points = 1                      1 type present..... points = 0                 </p>	<p><b>Figure</b> ____</p> <p style="text-align: right;">3</p>
H 1.3	<p><u>Richness of Plant Species</u> (see p. 75):                      Count the number of plant species in the wetland that cover at least 10 ft<sup>2</sup> (different patches of the same species can be combined to meet the size threshold)                      You do not have to name the species. Do not include Eurasian Milfoil, reed canarygrass, purple loosestrife, Canadian Thistle.                      If you counted:</p> <p style="text-align: right;">                     &gt; 19 species..... points = 2                      5 – 19 species..... points = 1                      &lt; 5 species..... points = 0                 </p> <p>List species below if you want to:                      _____                      _____                      _____</p>	<p style="text-align: right;">2</p>
H 1.4	<p><u>Interspersion of Habitats</u> (see p. 76):                      Decided from the diagrams below whether interspersion between Cowardin vegetation (described in H1.1), or the classes and unvegetated areas (can include open water or mudflats) is high, medium, low, or none.</p> <div style="display: flex; justify-content: space-around;"> <div style="text-align: center;">  <p>None = 0 points</p> </div> <div style="text-align: center;">  <p>Low = 1 point</p> </div> <div style="text-align: center;">  <p>Moderate = 2 points</p> </div> </div> <div style="display: flex; justify-content: space-around; margin-top: 20px;"> <div style="text-align: center;">  <p>High = 3 points</p> </div> <div style="text-align: center;">  <p>High = 3 points</p> </div> <div style="text-align: center;">  <p>[riparian braided channels]</p> </div> </div> <p style="text-align: right;"> <b>Note:</b> If you have 4 or more classes or 3 vegetation classes and open water, the rating is always “high”.   <b>Use map of Cowardin classes.</b> </p>	<p><b>Figure</b> ____</p> <p style="text-align: right;">2</p>
H 1.5	<p><u>Special Habitat Features</u> (see p. 77):                      Check the habitat features that are present in the wetland. The number of checks is the number of points you put into the next column.</p> <p><input checked="" type="checkbox"/> Large, downed, woody debris within the wetland (&gt; 4 in. diameter and 6 ft. long)  <input checked="" type="checkbox"/> Standing snags (diameter at the bottom &gt; 4 inches) in the wetland  <input type="checkbox"/> Undercut banks are present for at least 6.6 ft. (2m) and/or overhanging vegetation extends at least 3.3 ft. (1m) over a stream (or ditch) in, or contiguous with the unit, for at least 33 ft. (10m)  <input type="checkbox"/> Stable steep banks of fine material that might be used by beaver or muskrat for denning (&gt; 30 degree slope) OR signs of recent beaver activity are present (cut shrubs or trees that have not yet turned grey/brown)  <input type="checkbox"/> At least 1/4 acre of thin-stemmed persistent vegetation or woody branches are present in areas that are permanently or seasonally inundated (structures for egg-laying by amphibians)  <input type="checkbox"/> Invasive plants cover less than 25% of the wetland area in each stratum of plants</p> <p><i>NOTE: The 20% stated in early printings of the manual on page 78 is an error.</i></p>	<p style="text-align: right;">2</p>
<p><b>H 1 TOTAL Score</b> – potential for providing habitat</p>		<p style="text-align: right;">10</p>

Exhibit 16  
SSDP2016-00415  
001123



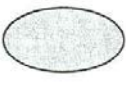

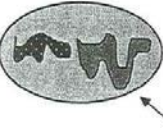
	<p>H 2.3 <u>Near or adjacent to other priority habitats listed by WDFW</u> (see p. 82): (see new and complete descriptions of WDFW priority habitats, and the counties in which they can be found, in the PHS report <a href="http://wdfw.wa.gov/hab/phslist.htm">http://wdfw.wa.gov/hab/phslist.htm</a> )</p> <p>Which of the following priority habitats are within 330 ft. (100m) of the wetland unit?  <i>NOTE: the connections do not have to be relatively undisturbed.</i></p> <p><input type="checkbox"/> <b>Aspen Stands:</b> Pure or mixed stands of aspen greater than 0.4 ha (1 acre).</p> <p><input type="checkbox"/> <b>Biodiversity Areas and Corridors:</b> Areas of habitat that are relatively important to various species of native fish and wildlife (full descriptions in WDFW PHS report p. 152).</p> <p><input type="checkbox"/> <b>Herbaceous Balds:</b> Variable size patches of grass and forbs on shallow soils over bedrock.</p> <p><input type="checkbox"/> <b>Old-growth/Mature forests:</b> (Old-growth west of Cascade crest) Stands of at least 2 tree species, forming a multi-layered canopy with occasional small openings; with at least 20 trees/ha (8 trees/acre) &gt; 81 cm (32 in) dbh or &gt; 200 years of age. (Mature forests) Stands with average diameters exceeding 53 cm (21 in) dbh; crown cover may be less than 100%; decay, decadence, numbers of snags, and quantity of large downed material is generally less than that found in old-growth; 80 - 200 years old west of the Cascade crest.</p> <p><input type="checkbox"/> <b>Oregon white Oak:</b> Woodlands Stands of pure oak or oak/conifer associations where canopy coverage of the oak component is important (full descriptions in WDFW PHS report p. 158).</p> <p><input checked="" type="checkbox"/> <b>Riparian:</b> The area adjacent to aquatic systems with flowing water that contains elements of both aquatic and terrestrial ecosystems which mutually influence each other.</p> <p><input type="checkbox"/> <b>Westside Prairies:</b> Herbaceous, non-forested plant communities that can either take the form of a dry prairie or a wet prairie (full descriptions in WDFW PHS report p. 161).</p> <p><input checked="" type="checkbox"/> <b>Instream:</b> The combination of physical, biological, and chemical processes and conditions that interact to provide functional life history requirements for instream fish and wildlife resources.</p> <p><input type="checkbox"/> <b>Nearshore:</b> Relatively undisturbed nearshore habitats. These include Coastal Nearshore, Open Coast Nearshore, and Puget Sound Nearshore. (full descriptions of habitats and the definition of relatively undisturbed are in WDFW report: pp. 167-169 and glossary in Appendix A).</p> <p><input type="checkbox"/> <b>Caves:</b> A naturally occurring cavity, recess, void, or system of interconnected passages under the earth in soils, rock, ice, or other geological formations and is large enough to contain a human.</p> <p><input type="checkbox"/> <b>Cliffs:</b> Greater than 7.6 m (25 ft) high and occurring below 5000 ft.</p> <p><input type="checkbox"/> <b>Talus:</b> Homogenous areas of rock rubble ranging in average size 0.15 - 2.0 m (0.5 - 6.5 ft), composed of basalt, andesite, and/or sedimentary rock, including riprap slides and mine tailings. May be associated with cliffs.</p> <p><input checked="" type="checkbox"/> <b>Snags and Logs:</b> Trees are considered snags if they are dead or dying and exhibit sufficient decay characteristics to enable cavity excavation/use by wildlife. Priority snags have a diameter at breast height of &gt; 51 cm (20 in) in western Washington and are &gt; 2 m (6.5 ft) in height. Priority logs are &gt; 30 cm (12 in) in diameter at the largest end, and &gt; 6 m (20 ft) long.</p> <p style="background-color: yellow;">If wetland has <b>3 or more</b> priority habitats = <b>4 points</b></p> <p>If wetland has <b>2</b> priority habitats = <b>3 points</b></p> <p>If wetland has <b>1</b> priority habitat = <b>1 point</b>                      No habitats = 0 points</p> <p>Note: All vegetated wetlands are by definition a priority habitat but are not included in this list. Nearby wetlands are addressed in question H 2.4)</p>	4
	<p>H 2.4 <u>Wetland Landscape:</u> Choose the <b>one</b> description of the landscape around the wetland that best fits (see p. 84)</p> <ul style="list-style-type: none"> <li>• There are at least 3 other wetlands within 1/2 mile, and the connections between them are relatively undisturbed (light grazing between wetlands OK, as is lake shore with some boating, but connections should NOT be bisected by paved roads, fill, fields, or other development.....points = 5</li> <li>• The wetland is Lake-fringe on a lake with little disturbance and there are 3 other lake-fringe wetlands within 1/2 mile .....points = 5</li> <li style="background-color: yellow;">• There are at least 3 other wetlands within 1/2 mile, BUT the connections between them are disturbed.....points = 3</li> <li>• The wetland fringe on a lake <b>with</b> disturbance and there are 3 other lake-fringe wetlands within 1/2 mile .....points = 3</li> <li>• There is at least 1 wetland within 1/2 mile .....points = 2</li> <li>• There are no wetlands within 1/2 mile.....points = 0</li> </ul>	3
	<p><b>H 2 TOTAL Score</b> – opportunity for providing habitat                      Add the scores from H2.1, H2.2, H2.3, H2.4</p>	9
	<p style="text-align: right;">TOTAL for H 1 from page 8</p>	10
◆	<p><b>Total Score for Habitat Functions</b>                      Add the points for H 1 and H 2; then <b>record the result on p. 1</b></p>	19

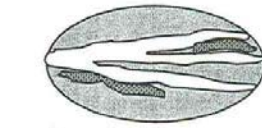
Comments:

### CATEGORIZATION BASED ON SPECIAL CHARACTERISTICS

*Please determine if the wetland meets the attributes described below  
and circle the appropriate answers and Category.*

<b>Wetland Type</b> – Check off any criteria that apply to the wetland. Circle the Category when the appropriate criteria are met.	
<b>SC1</b>	<p><b>Estuarine wetlands?</b> (see p.86)</p> <p>Does the wetland unit meet the following criteria for Estuarine wetlands?</p> <p><input type="checkbox"/> The dominant water regime is tidal,  <input type="checkbox"/> Vegetated, and  <input type="checkbox"/> With a salinity greater than 0.5 ppt.</p> <p style="text-align: center;">YES = Go to SC 1.1                      NO <u>  X  </u></p>
	<p>SC 1.1 Is the wetland unit within a National Wildlife Refuge, National Park, National Estuary Reserve, Natural Area Preserve, State Park or Educational, Environmental, or Scientific Reserve designated under WAC 332-30-151?    YES = Category I                      NO = go to SC 1.2</p>
	<p>SC 1.2 Is the wetland at least 1 acre in size and meets at least two of the following conditions?</p> <p style="text-align: center;">YES = Category I                      NO = Category II</p> <p><input type="checkbox"/> The wetland is relatively undisturbed (has no diking, ditching, filling, cultivation, grazing, and has less than 10% cover of non-native plant species. If the non-native <i>Spartina</i> spp., are only species that cover more than 10% of the wetland, then the wetland should be given a dual rating (I/II). The area of <i>Spartina</i> would be rated a Category II while the relatively undisturbed upper marsh with native species would be a Category I. Do not, however, exclude the area of <i>Spartina</i> in determining the size threshold of 1 acre.</p> <p><input type="checkbox"/> At least 3/4 of the landward edge of the wetland has a 100 ft. buffer of shrub, forest, or un-grazed or un-mowed grassland</p> <p><input type="checkbox"/> The wetland has at least 2 of the following features: tidal channels, depressions with open water, or contiguous freshwater wetlands.</p>
	<p><b>Cat. I</b></p> <p><b>Cat. II</b></p> <p><b>Dual Rating I/II</b></p>
<b>SC2</b>	<p><b>Natural Heritage Wetlands</b> (see p. 87)</p> <p>Natural Heritage wetlands have been identified by the Washington Natural Heritage Program/DNR as either high quality undisturbed wetlands or wetlands that support state Threatened, Endangered, or Sensitive plant species.</p> <p>SC 2.1 Is the wetland being rated in a Section/Township/Range that contains a natural heritage wetland? (<i>This question is used to screen out most sites before you need to contact WNHP/DNR.</i>)</p> <p style="text-align: center;">S/T/R information from Appendix D _____ or accessed from WNHP/DNR web site _____</p> <p style="text-align: center;">YES _____ Contact WNHP/DNR (see p. 79) and go to SC 2.2                      NO <u>  X  </u></p> <p>SC 2.2 Has DNR identified the wetland as a high quality undisturbed wetland or as a site with state threatened or endangered plant species?</p> <p style="text-align: center;">YES = Category 1                      NO _____ not a Heritage Wetland</p>
	<p><b>Cat I</b></p>
<b>SC3</b>	<p><b>Bogs</b> (see p. 87)</p> <p>Does the wetland (<b>or any part of the unit</b>) meet both the criteria for soils and vegetation in bogs? Use the key below to identify if the wetland is a bog. <i>If you answer yes you will still need to rate the wetland based on its function.</i></p> <ol style="list-style-type: none"> <li>1. Does the unit have organic soil horizons (i.e. layers of organic soil), either peats or mucks, that compose 16 inches or more of the first 32 inches of soil profile? (See Appendix B for a field key to identify organic soils)?    YES = go to question 3                      <b>NO = go to question 2</b></li> <li>2. Does the wetland have organic soils, either peats or mucks that are less than 16 inches deep over bedrock, or an impermeable hardpan such as clay or volcanic ash, or that are floating on a lake or pond?    YES = go to question 3                      <b>NO = is not a bog for purpose of rating</b></li> <li>3. Does the unit have more than 70% cover of mosses at ground level, AND other plants, if present, consist of the “bog” species listed in Table 3 as a significant component of the vegetation (more than 30% of the total shrub and herbaceous cover consists of species in Table 3)?</li> </ol> <p style="text-align: center;">YES = Is a bog for purpose of rating                      NO = go to question 4</p> <p>NOTE: If you are uncertain about the extent of mosses in the understory you may substitute that criterion by measuring the pH of the water that seeps into a hole dug at least 16” deep. If the pH is less than 5.0 and the “bog” plant species in Table 3 are present, the wetland is a bog.</p> <ol style="list-style-type: none"> <li>4. Is the unit forested (&gt; 30% cover) with sitka spruce, subalpine fir, western red cedar, western hemlock, lodgepole pine, quaking aspen, Englemann’s spruce, or western white pine. WITH any of the species (or combination of species) on the bog species plant list in Table 3 as a significant component of the ground cover (&gt; 30% coverage of the total shrub/herbaceous cover)?</li> </ol> <p style="text-align: center;">YES = Category I                      NO = Is not a bog for purpose of rating</p>
	<p><b>Cat. I</b></p>

**Exhibit 16**  
**SSDP2016-00415**  
**001126**

<p><b>SC4</b></p>	<p><b>Forested Wetlands</b> (see p. 90)                  Does the wetland have at least 1 acre of forest that meet one of these criteria for the Department of Fish and Wildlife's forests as priority habitats? <i>If you answer yes you will still need to rate the wetland based on its function.</i></p> <p>___ <b>Old-growth forests:</b> (west of Cascade Crest) Stands of at least two three species forming a multi-layered canopy with occasional small openings; with at least 8 trees/acre (20 trees/hectare) that are at least 200 years of age OR have a diameter at breast height (dbh) of 32 inches (81 cm or more).</p> <p>NOTE: The criterion for dbh is based on measurements for upland forests. Two-hundred year old trees in wetlands will often have a smaller dbh because their growth rates are often slower. The DFW criterion is and "OR" so old-growth forests do not necessarily have to have trees of this diameter.</p> <p>___ <b>Mature forests:</b> (west of the Cascade Crest) Stands where the largest trees are 80 – 200 years old OR have an average diameters (dbh) exceeding 21 inches (53 cm); crown cover may be less than 100%; decay, decadence, numbers of snags, and quantity of large downed material is generally less than that found in old-growth.</p> <p>YES = Category I                      NO = <u>X</u> not a forested wetland with special characteristics</p>	<p><b>Cat. I</b></p>
<p><b>SC5</b></p>	<p><b>Wetlands in Coastal Lagoons</b> (see p. 91)                  Does the wetland meet all of the following criteria of a wetland in a coastal lagoon?</p> <p>___ The wetland lies in a depression adjacent to marine waters that is wholly or partially separated from marine waters by sandbanks, gravel banks, shingle, or, less frequently, rocks.</p> <p>___ The lagoon in which the wetland is located contains surface water that is saline or brackish (&gt; 0.5 ppt) during most of the year in at least a portion of the lagoon (<i>needs to be measured near the bottom.</i>)</p> <p>YES = Go to SC 5.1                      NO <u>X</u> not a wetland in a coastal lagoon</p> <p>SC 5.1 Does the wetland meet all of the following three conditions?</p> <p>___ The wetland is relatively undisturbed (has no diking, ditching, filling, cultivation, grazing) and has less than 20% cover of invasive plant species (see list of invasive species on p. 74).</p> <p>___ At least 3/4 of the landward edge of the wetland has a 100 ft. buffer of shrub, forest, or un-grazed or un-mowed grassland.</p> <p>___ The wetland is larger than 1/10 acre (4350 square ft.)</p> <p>YES = Category I                      NO = Category II</p>	<p><b>Cat. I</b></p> <p><b>Cat. II</b></p>
<p><b>SC6</b></p>	<p><b>Interdunal Wetlands</b> (see p. 93)                  Is the wetland west of the 1889 line (also called the Western Boundary of Upland Ownership or WBUO)?</p> <p>YES = Go to SC 6.1                      NO <u>X</u> not an interdunal wetland for rating</p> <p><b><i>If you answer yes you will still need to rate the wetland based on its functions.</i></b></p> <p>In practical terms that means the following geographic areas:</p> <ul style="list-style-type: none"> <li>• Long Beach Peninsula -- lands west of SR 103</li> <li>• Grayland-Westport -- lands west of SR 105</li> <li>• Ocean Shores-Copalis – lands west of SR 115 and SR 109</li> </ul> <p>SC 6.1 Is the wetland one acre or larger, or is it in a mosaic of wetlands that is one acre or larger?</p> <p>YES = Category II                      NO = go to SC 6.2</p> <p>SC 6.2 Is the wetland between 0.1 and 1 acre, or is it in a mosaic of wetlands that is between 0.1 and 1 acre?</p> <p>YES = Category III</p>	<p><b>Cat. II</b></p> <p><b>Cat. III</b></p>
<p>◆</p>	<p><b>Category of wetland based on Special Characteristics</b>                  Choose the "highest" rating if wetland falls into several categories, and record on p. 1.                  If you answered NO for all types enter "Not Applicable" on p. 1</p>	<p><b>NA</b></p>

Comments:

Wetland name or number 24C

**WETLAND RATING FORM – WESTERN WASHINGTON**  
Version 2 – Updated July 2006 to increase accuracy and reproducibility among users  
Updated Oct. 2008 with the new WDFW definitions for priority habitats

Name of wetland (if known): 24C Date of site visit: 09-25-13

Rated by: Colin Worsley / Matt Maynard Trained by Ecology? Yes X No      Date of training: 11-2005 / 04-2006

SEC: 06 TOWNSHIP: 24N RANGE: 06E Is S/T/R in Appendix D? Yes      No X

Map of wetland unit: Figure                      Estimated size 0.16 acre

**SUMMARY OF RATING**

Category based on FUNCTIONS provided by wetland: I      II      III X IV     

Category I =	Score > 70
Category II =	Score 51 - 69
Category III =	Score 30 – 50
Category IV =	Score < 30

Score for Water Quality Functions	10
Score for Hydrologic Functions	10
Score for Habitat Functions	14
<b>TOTAL Score for Functions</b>	<b>34</b>

Category based on SPECIAL CHARACTERISTICS of Wetland I      II      Does not apply X

**Final Category** (choose the “highest” category from above”) **III**

**Summary of basic information about the wetland unit.**

Wetland Unit has Special Characteristics		Wetland HGM Class used for Rating	
<b>Estuarine</b>		<b>Depressional</b>	<b>X</b>
<b>Natural Heritage Wetland</b>		<b>Riverine</b>	<b>(x)</b>
<b>Bog</b>		<b>Lake-fringe</b>	
<b>Mature Forest</b>		<b>Slope</b>	
<b>Old Growth Forest</b>		<b>Flats</b>	
<b>Coastal Lagoon</b>		<b>Freshwater Tidal</b>	
<b>Interdunal</b>			
None of the above	X	Check if unit has multiple HGM classes present	<b>X</b>

**Does the wetland being rated meet any of the criteria below?** If you answer YES to any of the questions below you will need to protect the wetland according to the regulations regarding the special characteristics found in the wetland.

Check List for Wetlands that Need Additional Protection (in addition to the protection recommended for its category)	YES	NO
SP1. <i>Has the wetland unit been documented as a habitat for any Federally listed Threatened or Endangered <b>animal or plant</b> species (T/E species)?</i> For the purposes of this rating system, “documented” means the wetland is on the appropriate state or federal database.		X
SP2. <i>Has the wetland unit been documented as habitat for any State listed Threatened or Endangered <b>animal</b> species?</i> For the purposes of this rating system, “documented” means the wetland is on the appropriate state database. Note: Wetlands with State listed plant species are categorized as Category 1 Natural Heritage Wetlands (see p. 19 of data form).		X
SP3. <i>Does the wetland unit contain individuals of Priority species listed by the WDFW for the state?</i>		X
SP4. <i>Does the wetland unit have a local significance in addition to its functions?</i> For example, the wetland has been identified in the Shoreline Master Program, the Critical Areas Ordinance, or in a local management plan as having special significance.		X

To complete the next part of the data sheet you will need to determine the Hydrogeomorphic Class of the wetland being rated.

Exhibit 16  
SSDP2016-00415  
001128

### Classification of Vegetated Wetlands for Western Washington

If the hydrologic criteria listed in each question do not apply to the entire unit being rated, you probably have a unit with multiple HGM classes. In this case, identify which hydrologic criteria in questions 1-7 apply, and go to Question 8.

1. Are the water levels in the entire unit usually controlled by tides (i.e. except during floods)?

**NO – go to 2**

**YES – the wetland class is Tidal Fringe**

If yes, is the salinity of the water during periods of annual low flow below 0.5 ppt (parts per thousand)?

**YES – Freshwater Tidal Fringe**

**NO – Saltwater Tidal Fringe (Estuarine)**

*If your wetland can be classified as a Freshwater Tidal Fringe use the forms for Riverine wetlands. If it is a Saltwater Tidal Fringe it is rated as an Estuarine wetland. Wetlands that were call estuarine in the first and second editions of the rating system are called Salt Water Tidal Fringe in the Hydrogeomorphic Classification. Estuarine wetlands were categorized separately in the earlier editions, and this separation is being kept in this revision. To maintain consistency between editions, the term “Estuarine” wetland is kept. Please note, however, that the characteristics that define Category I and II estuarine wetlands have changed (see p. \_\_\_\_).*

2. The entire wetland unit is flat and precipitation is only source (>90%) of water to it. Groundwater and surface water runoff are NOT sources of water to the unit.

**NO – go to 3**

**YES – The wetland class is Flats**

If your wetland can be classified as a “Flats” wetland, use the form for **Depressional** wetlands.

3. Does the entire wetland meet both of the following criteria?

\_\_\_\_\_ The vegetated part of the wetland is on the shores of a body of permanent open water (without any vegetation on the surface) where at least 20 acres (8ha) in size;

\_\_\_\_\_ At least 30% of the open water area is deeper than 6.6 (2 m)?

**NO – go to 4**

**YES – The wetland class is Lake-fringe (Lacustrine Fringe)**

4. Does the entire wetland meet all of the following criteria?

\_\_\_\_\_ The wetland is on a slope (*slope can be very gradual*).

\_\_\_\_\_ The water flows through the wetland in one direction (unidirectional) and usually comes from seeps. It may flow subsurface, as sheetflow, or in a swale without distinct banks.

\_\_\_\_\_ The water leaves the wetland **without being impounded**?

*NOTE: Surface water does not pond in these types of wetlands except occasionally in very small and shallow depressions or behind hummocks (depressions are usually <3 ft diameter and less than 1 foot deep).*

**NO – go to 5**

**YES – The wetland class is Slope**

5. Does the entire wetland meet all of the following criteria?

\_\_\_\_\_ The unit is in a valley or stream channel where it gets inundated by overbank flooding from that stream or river.

\_\_\_\_\_ The overbank flooding occurs at least once every two years.

*NOTE: The riverine unit can contain depressions that are filled with water when the river is not flooding..*

**NO – go to 6**

**YES – The wetland class is Riverine**

6. Is the entire wetland unit in a topographic depression in which water ponds, or is saturated to the surface, at some time of the year. This means that any outlet, if present is higher than the interior of the wetland.

**NO – go to 7**

**YES – The wetland class is Depressional**

7. Is the entire wetland located in a very flat area with no obvious depression and no overbank flooding. The unit does not pond surface water more than a few inches. The unit seems to be maintained by high groundwater in the area. The wetland may be ditched, but has no obvious natural outlet.

**No – go to 8**

**YES – The wetland class is Depressional**

8. Your wetland unit seems to be difficult to classify and probably contains several different HGM classes. For example, seeps at the base of a slope may grade into a riverine floodplain, or a small stream within a depressional wetland has a zone of flooding along its sides. **GO BACK AND IDENTIFY WHICH OF THE HYDROLOGIC REGIMES DESCRIBED IN QUESTIONS 1-7 APPLY TO DIFFERENT AREAS IN THE UNIT** (make a rough sketch to help you decide). Use the following table to identify the appropriate class to use for the rating system if you have several HGM classes present within your wetland. *NOTE: Use this table only if the class that is recommended in the second column represents 10% or more of the total area of the wetland unit being rated. If the area of the class listed in column 2 is less than 10% of the unit, classify the wetland using the class that represents more than 90% of the total area.*

<i>HGM Classes within the wetland unit being rated</i>	<i>HGM Class to Use in Rating</i>
Slope + Riverine	Riverine
Slope + Depressional	Depressional
Slope + Lake-fringe	Lake-fringe
Depressional + Riverine along stream within boundary	Depressional
Depressional + Lake-fringe	Depressional
Salt Water Tidal Fringe and any other class of freshwater wetland	Treat as ESTUARINE under wetlands with special characteristics

**Exhibit 16**

**SSDP2016-00415**

**001129**







If you are unable still to determine which of the above criteria apply to your wetland, or you have more than 2 HGM classes within a wetland boundary, classify the wetland as **Depressional** for the rating.

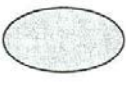

<b>D 4</b>	<p><b>Does the wetland have the <u>opportunity</u> to reduce flooding and erosion?</b></p> <p>Answer YES if the unit is in a location in the watershed where the flood storage, or reduction in water velocity, it provides helps protect downstream property and aquatic resources from flooding or excessive and/or erosive flows. Answer NO if the water coming into the wetland is controlled by a structure such as flood gate, tide gate, flap valve, reservoir etc. OR you estimate that more than 90% of the water in the wetland is from groundwater in areas where damaging groundwater flooding does not occur. <i>Note which of the following indicators of opportunity apply.</i></p> <p><input type="checkbox"/> Wetland is in a headwater of a river or stream that has flooding problems.</p> <p><input checked="" type="checkbox"/> Wetland drains to a river or stream that has flooding problems</p> <p><input type="checkbox"/> Wetland has no outlet and impounds surface runoff water that might otherwise flow into a river or stream that has flooding problems</p> <p><input type="checkbox"/> Other _____</p> <p><b>YES multiplier is 2</b>                      NO multiplier is 1</p>	<p>(see p. 49)</p> <p>Multiplier</p> <p><u>X2</u></p>
◆	<p><b>TOTAL – Hydrologic Functions</b>                      Multiply the score from D3 by D4; then <i>add score to table on p. 1</i></p>	<p>10</p>

Comments:

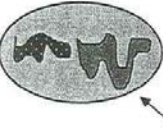

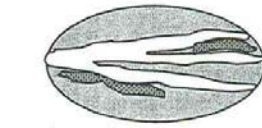
<p><i>These questions apply to wetlands of all HGM classes.</i></p> <p>HABITAT FUNCTIONS – Indicators that wetland functions to provide important habitat.</p>			<p><b>Points</b> (only 1 score per box)</p>
<b>H 1</b>	<p><b>Does the wetland have the potential to provide habitat for many species?</b></p>		
	<p>H 1.1 <u>Vegetation structure</u> (see P. 72):                      Check the types of vegetation classes present (as defined by Cowardin) – Size threshold for each class is 1/4 acre or more than 10% of the area if unit is smaller than 2.5 acres.  <input type="checkbox"/> Aquatic Bed  <input checked="" type="checkbox"/> Emergent plants  <input type="checkbox"/> Scrub/shrub (areas where shrubs have &gt; 30% cover)  <input checked="" type="checkbox"/> Forested (areas where trees have &gt; 30% cover)                      If the unit has a forested class check if:  <input checked="" type="checkbox"/> The forested class has 3 out of 5 strata (canopy, sub-canopy, shrubs, herbaceous, moss/ground-cover) that each cover 20% within the forested polygon.                      Add the number of vegetation types that qualify. If you have:     <b>Map of Cowardin vegetation classes</b>                        4 structures or more..... points = 4                         <b>3 structures..... points = 2</b>                        2 structures..... points = 1                                     1 structure ..... points = 0</p>	<p>Figure ____</p> <p style="text-align: right;">2</p>	
	<p>H 1.2 <u>Hydroperiods</u> (see p.73):                      Check the types of water regimes (hydroperiods) present within the wetland. The water regime has to cover more than 10% of the wetland or 1/4 acre to count (see text for descriptions of hydroperiods).  <input type="checkbox"/> Permanently flooded or inundated                                     4 or more types present   points = 3  <input checked="" type="checkbox"/> Seasonally flooded or inundated   <b>3 or more types present..... points = 2</b>  <input type="checkbox"/> Occasionally flooded or inundated                                       2 types present..... points = 1  <input checked="" type="checkbox"/> Saturated only   1 type present ..... points = 0  <input checked="" type="checkbox"/> Permanently flowing stream or river in, or adjacent to, the wetland  <input type="checkbox"/> Seasonally flowing stream in, or adjacent to, the wetland  <input type="checkbox"/> <b>Lake-fringe wetland..... = 2 points</b>  <input type="checkbox"/> <b>Freshwater tidal wetland..... = 2 points</b>  <span style="float: right;"><b>Map of hydroperiods</b></span></p>	<p>Figure ____</p> <p style="text-align: right;">2</p>	
	<p>H 1.3 <u>Richness of Plant Species</u> (see p. 75):                      Count the number of plant species in the wetland that cover at least 10 ft<sup>2</sup> (different patches of the same species can be combined to meet the size threshold)                      You do not have to name the species. Do not include Eurasian Milfoil, reed canarygrass, purple loosestrife, Canadian Thistle.                         If you counted:   &gt; 19 species ..... points = 2  <span style="float: right;"><b>5 – 19 species..... points = 1</b></span>                        &lt; 5 species ..... points = 0</p> <p>List species below if you want to:</p> <hr/> <hr/> <hr/>	<p>Figure ____</p> <p style="text-align: right;">1</p>	
	<p>H 1.4 <u>Interspersion of Habitats</u> (see p. 76):                      Decided from the diagrams below whether interspersion between Cowardin vegetation (described in H1.1), or the classes and unvegetated areas (can include open water or mudflats) is high, medium, low, or none.</p> <div style="display: flex; justify-content: space-around;">     </div> <div style="display: flex; justify-content: space-around; margin-top: 10px;">    </div> <p style="text-align: center;">High = 3 points     [riparian braided channels]</p> <div style="margin-top: 20px; border: 1px solid black; padding: 5px;"> <p>Note: If you have 4 or more classes or 3 vegetation classes and open water, the rating is always “high”.</p> <p style="text-align: center;"><b>Use map of Cowardin classes.</b></p> </div>	<p>Figure ____</p> <p style="text-align: right;">1</p>	
	<p>H 1.5 <u>Special Habitat Features</u> (see p. 77):                      Check the habitat features that are present in the wetland. The number of checks is the number of points you put into the next column.</p> <ul style="list-style-type: none"> <li><input type="checkbox"/> Large, downed, woody debris within the wetland (&gt; 4 in. diameter and 6 ft. long)</li> <li><input type="checkbox"/> Standing snags (diameter at the bottom &gt; 4 inches) in the wetland</li> <li><input type="checkbox"/> Undercut banks are present for at least 6.6 ft. (2m) and/or overhanging vegetation extends at least 3.3 ft. (1m) over a stream (or ditch) in, or contiguous with the unit, for at least 33 ft. (10m)</li> <li><input type="checkbox"/> Stable steep banks of fine material that might be used by beaver or muskrat for denning (&gt; 30 degree slope) OR signs of recent beaver activity are present (cut shrubs or trees that have not yet turned grey/brown)</li> <li><input type="checkbox"/> At least 1/4 acre of thin-stemmed persistent vegetation or woody branches are present in areas that are permanently or seasonally inundated (structures for egg-laying by amphibians)</li> <li><input type="checkbox"/> Invasive plants cover less than 25% of the wetland area in each stratum of plants</li> </ul> <p style="font-size: small;">NOTE: The 20% stated in early printings of the manual on page 78 is an error.</p>	<p>Figure ____</p> <p style="text-align: right;">0</p>	
<p><b>H 1 TOTAL Score</b> – potential for providing habitat</p>		<p>Add the points in the column above</p>	<p style="color: red; font-weight: bold;">Exhibit 16 SSDP2016-00415 001132</p> <p style="text-align: right; font-weight: bold;">6</p>

<b>H 2</b>	<b>Does the wetland have the <u>opportunity</u> to provide habitat for many species?</b>	(only 1 score per box)
	<p>H 2.1 <b>Buffers</b> (see P. 80):  <i>Choose the description that best represents condition of buffer of wetland unit. The highest scoring criterion that applies to the wetland is to be used in the rating. See text for definition of "undisturbed".</i></p> <p><input type="checkbox"/> 100m (330 ft) of relatively undisturbed vegetated areas, rocky areas, or open water &gt; 95% of circumference. No structures are within the undisturbed part of buffer (relatively undisturbed also means no grazing, no landscaping, no daily human use)..... <b>points = 5</b></p> <p><input type="checkbox"/> 100m (330 ft) of relatively undisturbed vegetated areas, rocky areas, or open water &gt; 50% circumference..... <b>points = 4</b></p> <p><input type="checkbox"/> 50m (170 ft) of relatively undisturbed vegetated areas, rocky areas, or open water &gt; 95% circumference..... <b>points = 4</b></p> <p><input type="checkbox"/> 100m (330 ft) of relatively undisturbed vegetated areas, rocky areas, or open water &gt; 25% circumference..... <b>points = 3</b></p> <p><input type="checkbox"/> 50m (170 ft) of relatively undisturbed vegetated areas, rocky areas, or open water for &gt; 50% circumference..... <b>points = 3</b></p> <p><b>If buffer does not meet any of the criteria above:</b></p> <p><input type="checkbox"/> No paved areas (except paved trails) or buildings within 25m (80 ft) of wetland &gt; 95% circumference. Light to moderate grazing or lawns are OK..... <b>points = 2</b></p> <p><input type="checkbox"/> No paved areas of buildings within 50m of wetland for &gt; 50% circumference. Light to moderate grazing or lawns are OK..... <b>points = 2</b></p> <p><input type="checkbox"/> Heavy grazing in buffer..... <b>points = 1</b></p> <p><input type="checkbox"/> Vegetated buffers are &lt; 2m wide (6.6 ft) for more than 95% circumference (e.g. tilled fields, paving, basalt bedrock extend to edge of wetland)..... <b>points = 0</b></p> <p><input checked="" type="checkbox"/> Buffer does not meet any of the criteria above..... <b>points = 1</b></p> <p style="text-align: right;"><b>Arial photo showing buffers</b></p>	<p><b>Figure</b> ____</p> <p style="text-align: center;">1</p>
	<p>H 2.2 <b>Corridors and Connections</b> (see p. 81)</p> <p>H 2.2.1 Is the wetland part of a relatively undisturbed and unbroken vegetated corridor (either riparian or upland) that is at least 150 ft. wide, has at least a 30% cover of shrubs, forest or native undisturbed prairie, that connects to estuaries, other wetlands or undisturbed uplands that are at least 250 acres in size? (<i>Dams in riparian corridors, heavily used gravel roads, paved roads, are considered breaks in the corridor.</i>)</p> <p style="text-align: center;">YES = <b>4 points</b> (go to H 2.3) <span style="margin-left: 100px;"><b>NO = go to H 2.2.2</b></span></p> <p>H. 2.2.2 Is the wetland part of a relatively undisturbed and unbroken vegetated corridor (either riparian or upland) that is at least 50 ft. wide, has at least 30% cover of shrubs or forest, and connects to estuaries, other wetlands or undisturbed uplands that are at least 25 acres in size? <b>OR a Lake-fringe</b> wetland, if it does not have an undisturbed corridor as in the question above?</p> <p style="text-align: center;">YES = <b>2 points</b> (go to H 2.3) <span style="margin-left: 100px;"><b>NO = go to H 2.2.3</b></span></p> <p>H. 2.2.3 Is the wetland:</p> <ul style="list-style-type: none"> <li>• Within 5 mi (8km) of a brackish or salt water estuary OR</li> <li>• Within 3 miles of a large field or pasture (&gt; 40 acres) OR <span style="float: right;"><b>YES = 1 point</b></span></li> <li>• <b>Within 1 mile of a lake greater than 20 acres?</b> <span style="float: right;"><b>NO = 0 points</b></span></li> </ul>	<p style="text-align: center;">1</p>

**Comments:**

	<p>H 2.3 <u>Near or adjacent to other priority habitats listed by WDFW</u> (see p. 82): (see new and complete descriptions of WDFW priority habitats, and the counties in which they can be found, in the PHS report <a href="http://wdfw.wa.gov/hab/phslist.htm">http://wdfw.wa.gov/hab/phslist.htm</a> )</p> <p>Which of the following priority habitats are within 330 ft. (100m) of the wetland unit?  <i>NOTE: the connections do not have to be relatively undisturbed.</i></p> <p><input type="checkbox"/> <b>Aspen Stands:</b> Pure or mixed stands of aspen greater than 0.4 ha (1 acre).</p> <p><input type="checkbox"/> <b>Biodiversity Areas and Corridors:</b> Areas of habitat that are relatively important to various species of native fish and wildlife (full descriptions in WDFW PHS report p. 152).</p> <p><input type="checkbox"/> <b>Herbaceous Balds:</b> Variable size patches of grass and forbs on shallow soils over bedrock.</p> <p><input type="checkbox"/> <b>Old-growth/Mature forests:</b> (Old-growth west of Cascade crest) Stands of at least 2 tree species, forming a multi-layered canopy with occasional small openings; with at least 20 trees/ha (8 trees/acre) &gt; 81 cm (32 in) dbh or &gt; 200 years of age. (Mature forests) Stands with average diameters exceeding 53 cm (21 in) dbh; crown cover may be less than 100%; decay, decadence, numbers of snags, and quantity of large downed material is generally less than that found in old-growth; 80 - 200 years old west of the Cascade crest.</p> <p><input type="checkbox"/> <b>Oregon white Oak:</b> Woodlands Stands of pure oak or oak/conifer associations where canopy coverage of the oak component is important (full descriptions in WDFW PHS report p. 158).</p> <p><input checked="" type="checkbox"/> <b>Riparian:</b> The area adjacent to aquatic systems with flowing water that contains elements of both aquatic and terrestrial ecosystems which mutually influence each other.</p> <p><input type="checkbox"/> <b>Westside Prairies:</b> Herbaceous, non-forested plant communities that can either take the form of a dry prairie or a wet prairie (full descriptions in WDFW PHS report p. 161).</p> <p><input checked="" type="checkbox"/> <b>Instream:</b> The combination of physical, biological, and chemical processes and conditions that interact to provide functional life history requirements for instream fish and wildlife resources.</p> <p><input type="checkbox"/> <b>Nearshore:</b> Relatively undisturbed nearshore habitats. These include Coastal Nearshore, Open Coast Nearshore, and Puget Sound Nearshore. (full descriptions of habitats and the definition of relatively undisturbed are in WDFW report: pp. 167-169 and glossary in Appendix A).</p> <p><input type="checkbox"/> <b>Caves:</b> A naturally occurring cavity, recess, void, or system of interconnected passages under the earth in soils, rock, ice, or other geological formations and is large enough to contain a human.</p> <p><input type="checkbox"/> <b>Cliffs:</b> Greater than 7.6 m (25 ft) high and occurring below 5000 ft.</p> <p><input type="checkbox"/> <b>Talus:</b> Homogenous areas of rock rubble ranging in average size 0.15 - 2.0 m (0.5 - 6.5 ft), composed of basalt, andesite, and/or sedimentary rock, including riprap slides and mine tailings. May be associated with cliffs.</p> <p><input type="checkbox"/> <b>Snags and Logs:</b> Trees are considered snags if they are dead or dying and exhibit sufficient decay characteristics to enable cavity excavation/use by wildlife. Priority snags have a diameter at breast height of &gt; 51 cm (20 in) in western Washington and are &gt; 2 m (6.5 ft) in height. Priority logs are &gt; 30 cm (12 in) in diameter at the largest end, and &gt; 6 m (20 ft) long.</p> <p>If wetland has <b>3 or more</b> priority habitats = <b>4 points</b>  <b>If wetland has 2</b> priority habitats = <b>3 points</b>                  If wetland has <b>1</b> priority habitat = <b>1 point</b>                      No habitats = 0 points</p> <p>Note: All vegetated wetlands are by definition a priority habitat but are not included in this list. Nearby wetlands are addressed in question H 2.4)</p>	3
	<p>H 2.4 <u>Wetland Landscape:</u> Choose the <b>one</b> description of the landscape around the wetland that best fits (see p. 84)</p> <ul style="list-style-type: none"> <li>• There are at least 3 other wetlands within 1/2 mile, and the connections between them are relatively undisturbed (light grazing between wetlands OK, as is lake shore with some boating, but connections should NOT be bisected by paved roads, fill, fields, or other development.....points = 5</li> <li>• The wetland is Lake-fringe on a lake with little disturbance and there are 3 other lake-fringe wetlands within 1/2 mile .....points = 5</li> <li>• <b>There are at least 3 other wetlands within 1/2 mile, BUT the connections between them are disturbed.....points = 3</b></li> <li>• The wetland fringe on a lake <b>with</b> disturbance and there are 3 other lake-fringe wetlands within 1/2 mile .....points = 3</li> <li>• There is at least 1 wetland within 1/2 mile .....points = 2</li> <li>• There are no wetlands within 1/2 mile.....points = 0</li> </ul>	3
<p><b>H 2 TOTAL Score</b> – opportunity for providing habitat                      Add the scores from H2.1, H2.2, H2.3, H2.4</p>		8
<p style="text-align: right;"><i>TOTAL for H 1 from page 8</i></p>		6
◆	<p><b>Total Score for Habitat Functions</b>                      Add the points for H 1 and H 2; then <b>record the result on p. 1</b></p>	14

Comments:

### CATEGORIZATION BASED ON SPECIAL CHARACTERISTICS

*Please determine if the wetland meets the attributes described below  
and circle the appropriate answers and Category.*

<b>Wetland Type</b> – Check off any criteria that apply to the wetland. Circle the Category when the appropriate criteria are met.		
<b>SC1</b>	<p><b>Estuarine wetlands?</b> (see p.86)</p> <p>Does the wetland unit meet the following criteria for Estuarine wetlands?</p> <p><input type="checkbox"/> The dominant water regime is tidal,</p> <p><input type="checkbox"/> Vegetated, and</p> <p><input type="checkbox"/> With a salinity greater than 0.5 ppt.</p> <p style="text-align: center;">YES = Go to SC 1.1                      NO <u>  X  </u></p>	
SC 1.1	<p>Is the wetland unit within a National Wildlife Refuge, National Park, National Estuary Reserve, Natural Area Preserve, State Park or Educational, Environmental, or Scientific Reserve designated under WAC 332-30-151?    YES = Category I                      NO = go to SC 1.2</p>	<b>Cat. I</b>
SC 1.2	<p>Is the wetland at least 1 acre in size and meets at least two of the following conditions?</p> <p style="text-align: center;">YES = Category I                      NO = Category II</p> <p><input type="checkbox"/> The wetland is relatively undisturbed (has no diking, ditching, filling, cultivation, grazing, and has less than 10% cover of non-native plant species. If the non-native <i>Spartina</i> spp., are only species that cover more than 10% of the wetland, then the wetland should be given a dual rating (I/II). The area of <i>Spartina</i> would be rated a Category II while the relatively undisturbed upper marsh with native species would be a Category I. Do not, however, exclude the area of <i>Spartina</i> in determining the size threshold of 1 acre.</p> <p><input type="checkbox"/> At least 3/4 of the landward edge of the wetland has a 100 ft. buffer of shrub, forest, or un-grazed or un-mowed grassland</p> <p><input type="checkbox"/> The wetland has at least 2 of the following features: tidal channels, depressions with open water, or contiguous freshwater wetlands.</p>	<b>Cat. I</b>  <b>Cat. II</b>  <b>Dual Rating I/II</b>
<b>SC2</b>	<p><b>Natural Heritage Wetlands</b> (see p. 87)</p> <p>Natural Heritage wetlands have been identified by the Washington Natural Heritage Program/DNR as either high quality undisturbed wetlands or wetlands that support state Threatened, Endangered, or Sensitive plant species.</p> <p>SC 2.1 Is the wetland being rated in a Section/Township/Range that contains a natural heritage wetland? (<i>This question is used to screen out most sites before you need to contact WNHP/DNR.</i>)</p> <p style="text-align: center;">S/T/R information from Appendix D _____ or accessed from WNHP/DNR web site _____</p> <p style="text-align: center;">YES _____ Contact WNHP/DNR (see p. 79) and go to SC 2.2                      NO <u>  X  </u></p> <p>SC 2.2 Has DNR identified the wetland as a high quality undisturbed wetland or as a site with state threatened or endangered plant species?</p> <p style="text-align: center;">YES = Category 1                      NO _____ not a Heritage Wetland</p>	<b>Cat I</b>
<b>SC3</b>	<p><b>Bogs</b> (see p. 87)</p> <p>Does the wetland (<b>or any part of the unit</b>) meet both the criteria for soils and vegetation in bogs? Use the key below to identify if the wetland is a bog. <i>If you answer yes you will still need to rate the wetland based on its function.</i></p> <ol style="list-style-type: none"> <li>1. Does the unit have organic soil horizons (i.e. layers of organic soil), either peats or mucks, that compose 16 inches or more of the first 32 inches of soil profile? (See Appendix B for a field key to identify organic soils)?    YES = go to question 3                      <b>NO = go to question 2</b></li> <li>2. Does the wetland have organic soils, either peats or mucks that are less than 16 inches deep over bedrock, or an impermeable hardpan such as clay or volcanic ash, or that are floating on a lake or pond?    YES = go to question 3                      <b>NO = is not a bog for purpose of rating</b></li> <li>3. Does the unit have more than 70% cover of mosses at ground level, AND other plants, if present, consist of the “bog” species listed in Table 3 as a significant component of the vegetation (more than 30% of the total shrub and herbaceous cover consists of species in Table 3)?</li> </ol> <p style="text-align: center;">YES = Is a bog for purpose of rating                      NO = go to question 4</p> <p>NOTE: If you are uncertain about the extent of mosses in the understory you may substitute that criterion by measuring the pH of the water that seeps into a hole dug at least 16” deep. If the pH is less than 5.0 and the “bog” plant species in Table 3 are present, the wetland is a bog.</p> <ol style="list-style-type: none"> <li>4. Is the unit forested (&gt; 30% cover) with sitka spruce, subalpine fir, western red cedar, western hemlock, lodgepole pine, quaking aspen, Englemann’s spruce, or western white pine. WITH any of the species (or combination of species) on the bog species plant list in Table 3 as a significant component of the ground cover (&gt; 30% coverage of the total shrub/herbaceous cover)?</li> </ol> <p style="text-align: center;">YES = Category I                      NO = Is not a bog for purpose of rating</p>	<b>Cat. I</b>

**Exhibit 16**  
**SSDP2016-00415**  
**001135**

SC4	<p><b>Forested Wetlands</b> (see p. 90)</p> <p>Does the wetland have at least 1 acre of forest that meet one of these criteria for the Department of Fish and Wildlife's forests as priority habitats? <i>If you answer yes you will still need to rate the wetland based on its function.</i></p> <p>___ <b>Old-growth forests:</b> (west of Cascade Crest) Stands of at least two three species forming a multi-layered canopy with occasional small openings; with at least 8 trees/acre (20 trees/hectare) that are at least 200 years of age OR have a diameter at breast height (dbh) of 32 inches (81 cm or more).</p> <p>NOTE: The criterion for dbh is based on measurements for upland forests. Two-hundred year old trees in wetlands will often have a smaller dbh because their growth rates are often slower. The DFW criterion is and "OR" so old-growth forests do not necessarily have to have trees of this diameter.</p> <p>___ <b>Mature forests:</b> (west of the Cascade Crest) Stands where the largest trees are 80 – 200 years old OR have an average diameters (dbh) exceeding 21 inches (53 cm); crown cover may be less than 100%; decay, decadence, numbers of snags, and quantity of large downed material is generally less than that found in old-growth.</p> <p>YES = Category I                      NO = <u>X</u> not a forested wetland with special characteristics</p>	Cat. I
SC5	<p><b>Wetlands in Coastal Lagoons</b> (see p. 91)</p> <p>Does the wetland meet all of the following criteria of a wetland in a coastal lagoon?</p> <p>___ The wetland lies in a depression adjacent to marine waters that is wholly or partially separated from marine waters by sandbanks, gravel banks, shingle, or, less frequently, rocks.</p> <p>___ The lagoon in which the wetland is located contains surface water that is saline or brackish (&gt; 0.5 ppt) during most of the year in at least a portion of the lagoon (<i>needs to be measured near the bottom.</i>)</p> <p>YES = Go to SC 5.1                      NO <u>X</u> not a wetland in a coastal lagoon</p> <p>SC 5.1 Does the wetland meet all of the following three conditions?</p> <p>___ The wetland is relatively undisturbed (has no diking, ditching, filling, cultivation, grazing) and has less than 20% cover of invasive plant species (see list of invasive species on p. 74).</p> <p>___ At least 3/4 of the landward edge of the wetland has a 100 ft. buffer of shrub, forest, or un-grazed or un-mowed grassland.</p> <p>___ The wetland is larger than 1/10 acre (4350 square ft.)</p> <p>YES = Category I                      NO = Category II</p>	Cat. I Cat. II
SC6	<p><b>Interdunal Wetlands</b> (see p. 93)</p> <p>Is the wetland west of the 1889 line (also called the Western Boundary of Upland Ownership or WBUO)?</p> <p>YES = Go to SC 6.1                      NO <u>X</u> not an interdunal wetland for rating</p> <p><i>If you answer yes you will still need to rate the wetland based on its functions.</i></p> <p>In practical terms that means the following geographic areas:</p> <ul style="list-style-type: none"> <li>• Long Beach Peninsula -- lands west of SR 103</li> <li>• Grayland-Westport -- lands west of SR 105</li> <li>• Ocean Shores-Copalis – lands west of SR 115 and SR 109</li> </ul> <p>SC 6.1 Is the wetland one acre or larger, or is it in a mosaic of wetlands that is one acre or larger?</p> <p>YES = Category II                      NO = go to SC 6.2</p> <p>SC 6.2 Is the wetland between 0.1 and 1 acre, or is it in a mosaic of wetlands that is between 0.1 and 1 acre?</p> <p>YES = Category III</p>	Cat. II Cat. III
◆	<p><b>Category of wetland based on Special Characteristics</b></p> <p>Choose the "highest" rating if wetland falls into several categories, and record on p. 1.</p> <p>If you answered NO for all types enter "Not Applicable" on p. 1</p>	NA

Comments:

Wetland name or number 25A

**WETLAND RATING FORM – WESTERN WASHINGTON**  
Version 2 – Updated July 2006 to increase accuracy and reproducibility among users  
Updated Oct. 2008 with the new WDFW definitions for priority habitats

Name of wetland (if known): 25A Date of site visit: 09-25-13

Rated by: Colin Worsley / Matt Maynard Trained by Ecology? Yes  No  Date of training: 11-2005 / 04-2006

SEC: 32 TOWNSHIP: 25N RANGE: 06E Is S/T/R in Appendix D? Yes  No

Map of wetland unit: Figure \_\_\_\_\_ Estimated size 0.25 acre

**SUMMARY OF RATING**

Category based on FUNCTIONS provided by wetland: I \_\_\_\_\_ II \_\_\_\_\_ III  IV \_\_\_\_\_

Category I =	Score > 70
Category II =	Score 51 - 69
Category III =	Score 30 – 50
Category IV =	Score < 30

Score for Water Quality Functions	20
Score for Hydrologic Functions	12
Score for Habitat Functions	14
<b>TOTAL Score for Functions</b>	<b>46</b>

Category based on SPECIAL CHARACTERISTICS of Wetland I \_\_\_\_\_ II \_\_\_\_\_ Does not apply

**Final Category** (choose the “highest” category from above”) **III**

**Summary of basic information about the wetland unit.**

Wetland Unit has Special Characteristics		Wetland HGM Class used for Rating	
<b>Estuarine</b>		<b>Depressional</b>	<b>X</b>
<b>Natural Heritage Wetland</b>		<b>Riverine</b>	<b>(x)</b>
<b>Bog</b>		<b>Lake-fringe</b>	
<b>Mature Forest</b>		<b>Slope</b>	
<b>Old Growth Forest</b>		<b>Flats</b>	
<b>Coastal Lagoon</b>		<b>Freshwater Tidal</b>	
<b>Interdunal</b>			
None of the above	X	Check if unit has multiple HGM classes present	<b>X</b>

**Does the wetland being rated meet any of the criteria below?** If you answer YES to any of the questions below you will need to protect the wetland according to the regulations regarding the special characteristics found in the wetland.

Check List for Wetlands that Need Additional Protection (in addition to the protection recommended for its category)	YES	NO
SP1. <i>Has the wetland unit been documented as a habitat for any Federally listed Threatened or Endangered <b>animal or plant</b> species (T/E species)?</i> For the purposes of this rating system, “documented” means the wetland is on the appropriate state or federal database.		X
SP2. <i>Has the wetland unit been documented as habitat for any State listed Threatened or Endangered <b>animal</b> species?</i> For the purposes of this rating system, “documented” means the wetland is on the appropriate state database. Note: Wetlands with State listed plant species are categorized as Category 1 Natural Heritage Wetlands (see p. 19 of data form).		X
SP3. <i>Does the wetland unit contain individuals of Priority species listed by the WDFW for the state?</i>		X
SP4. <i>Does the wetland unit have a local significance in addition to its functions?</i> For example, the wetland has been identified in the Shoreline Master Program, the Critical Areas Ordinance, or in a local management plan as having special significance.		X

To complete the next part of the data sheet you will need to determine the Hydrogeomorphic Class of the wetland being rated.

Exhibit 16  
SSDP2016-00415  
001137

### Classification of Vegetated Wetlands for Western Washington

If the hydrologic criteria listed in each question do not apply to the entire unit being rated, you probably have a unit with multiple HGM classes. In this case, identify which hydrologic criteria in questions 1-7 apply, and go to Question 8.

1. Are the water levels in the entire unit usually controlled by tides (i.e. except during floods)?  
NO – go to 2                      **YES – the wetland class is Tidal Fringe**  
 If yes, is the salinity of the water during periods of annual low flow below 0.5 ppt (parts per thousand)?  
**YES – Freshwater Tidal Fringe**                      **NO – Saltwater Tidal Fringe (Estuarine)**  
*If your wetland can be classified as a Freshwater Tidal Fringe use the forms for Riverine wetlands. If it is a Saltwater Tidal Fringe it is rated as an Estuarine wetland. Wetlands that were call estuarine in the first and second editions of the rating system are called Salt Water Tidal Fringe in the Hydrogeomorphic Classification. Estuarine wetlands were categorized separately in the earlier editions, and this separation is being kept in this revision. To maintain consistency between editions, the term “Estuarine” wetland is kept. Please note, however, that the characteristics that define Category I and II estuarine wetlands have changed (see p. \_\_\_\_).*

---

2. The entire wetland unit is flat and precipitation is only source (>90%) of water to it. Groundwater and surface water runoff are NOT sources of water to the unit.  
NO – go to 3                      **YES – The wetland class is Flats**  
 If your wetland can be classified as a “Flats” wetland, use the form for **Depressional** wetlands.

---

3. Does the entire wetland meet both of the following criteria?  
 \_\_\_\_\_ The vegetated part of the wetland is on the shores of a body of permanent open water (without any vegetation on the surface) where at least 20 acres (8ha) in size;  
 \_\_\_\_\_ At least 30% of the open water area is deeper than 6.6 (2 m)?  
NO – go to 4                      **YES – The wetland class is Lake-fringe (Lacustrine Fringe)**

---

4. Does the entire wetland meet all of the following criteria?  
 \_\_\_\_\_ The wetland is on a slope (*slope can be very gradual*).  
 \_\_\_\_\_ The water flows through the wetland in one direction (unidirectional) and usually comes from seeps. It may flow subsurface, as sheetflow, or in a swale without distinct banks.  
 \_\_\_\_\_ The water leaves the wetland **without being impounded**?  
 NOTE: *Surface water does not pond in these types of wetlands except occasionally in very small and shallow depressions or behind hummocks (depressions are usually <3 ft diameter and less than 1 foot deep).*  
NO – go to 5                      **YES – The wetland class is Slope**

---

5. Does the entire wetland meet all of the following criteria?  
 \_\_\_\_\_ The unit is in a valley or stream channel where it gets inundated by overbank flooding from that stream or river.  
 \_\_\_\_\_ The overbank flooding occurs at least once every two years.  
 NOTE: *The riverine unit can contain depressions that are filled with water when the river is not flooding..*  
NO – go to 6                      **YES – The wetland class is Riverine**

---

6. Is the entire wetland unit in a topographic depression in which water ponds, or is saturated to the surface, at some time of the year. This means that any outlet, if present is higher than the interior of the wetland.  
NO – go to 7                      **YES – The wetland class is Depressional**

---

7. Is the entire wetland located in a very flat area with no obvious depression and no overbank flooding. The unit does not pond surface water more than a few inches. The unit seems to be maintained by high groundwater in the area. The wetland may be ditched, but has no obvious natural outlet.  
No – go to 8                      **YES – The wetland class is Depressional**

---

8. Your wetland unit seems to be difficult to classify and probably contains several different HGM classes. For example, seeps at the base of a slope may grade into a riverine floodplain, or a small stream within a depressional wetland has a zone of flooding along its sides. **GO BACK AND IDENTIFY WHICH OF THE HYDROLOGIC REGIMES DESCRIBED IN QUESTIONS 1-7 APPLY TO DIFFERENT AREAS IN THE UNIT** (make a rough sketch to help you decide). Use the following table to identify the appropriate class to use for the rating system if you have several HGM classes present within your wetland. NOTE: Use this table only if the class that is recommended in the second column represents 10% or more of the total area of the wetland unit being rated. If the area of the class listed in column 2 is less than 10% of the unit, classify the wetland using the class that represents more than 90% of the total area.

HGM Classes within the wetland unit being rated	HGM Class to Use in Rating
Slope + Riverine	Riverine
Slope + Depressional	Depressional
Slope + Lake-fringe	Lake-fringe
Depressional + Riverine along stream within boundary	Depressional
Depressional + Lake-fringe	Depressional
Salt Water Tidal Fringe and any other class of freshwater wetland	Treat as ESTUARINE under wetlands with special characteristics

If you are unable still to determine which of the above criteria apply to your wetland, or you have more than 2 HGM classes within a wetland boundary, classify the wetland as **Depressional** for the rating.

Exhibit 16  
SSDP2016-00415  
001138





<b>D 4</b>	<p><b>Does the wetland have the <u>opportunity</u> to reduce flooding and erosion?</b></p> <p>Answer YES if the unit is in a location in the watershed where the flood storage, or reduction in water velocity, it provides helps protect downstream property and aquatic resources from flooding or excessive and/or erosive flows. Answer NO if the water coming into the wetland is controlled by a structure such as flood gate, tide gate, flap valve, reservoir etc. OR you estimate that more than 90% of the water in the wetland is from groundwater in areas where damaging groundwater flooding does not occur. <i>Note which of the following indicators of opportunity apply.</i></p> <p><input type="checkbox"/> Wetland is in a headwater of a river or stream that has flooding problems.</p> <p><input checked="" type="checkbox"/> Wetland drains to a river or stream that has flooding problems</p> <p><input type="checkbox"/> Wetland has no outlet and impounds surface runoff water that might otherwise flow into a river or stream that has flooding problems</p> <p><input type="checkbox"/> Other _____</p> <p><b>YES multiplier is 2</b>                      NO multiplier is 1</p>	<p>(see p. 49)</p> <p>Multiplier</p> <p><u>X2</u></p>
◆	<p><b>TOTAL – Hydrologic Functions</b>                      Multiply the score from D3 by D4; then <i>add score to table on p. 1</i></p>	<p>12</p>

Comments:





<p><i>These questions apply to wetlands of all HGM classes.</i></p> <p>HABITAT FUNCTIONS – Indicators that wetland functions to provide important habitat.</p>		<p><b>Points</b> (only 1 score per box)</p>
<b>H 1</b>	<b>Does the wetland have the <u>potential</u> to provide habitat for many species?</b>	
H 1.1	<p><u>Vegetation structure</u> (see P. 72):                      Check the types of vegetation classes present (as defined by Cowardin) – Size threshold for each class is 1/4 acre or more than 10% of the area if unit is smaller than 2.5 acres.</p> <p><input type="checkbox"/> Aquatic Bed  <input type="checkbox"/> Emergent plants  <input type="checkbox"/> Scrub/shrub (areas where shrubs have &gt; 30% cover)  <input checked="" type="checkbox"/> Forested (areas where trees have &gt; 30% cover)                      If the unit has a forested class check if:  <input type="checkbox"/> The forested class has 3 out of 5 strata (canopy, sub-canopy, shrubs, herbaceous, moss/ground-cover) that each cover 20% within the forested polygon.                      Add the number of vegetation types that qualify. If you have:</p> <p style="text-align: right;"> <b>Map of Cowardin vegetation classes</b>                      4 structures or more..... points = 4                      3 structures..... points = 2                      2 structures..... points = 1                      1 structure..... points = 0                 </p>	<p><b>Figure</b> ____</p> <p style="text-align: right;">1</p>
H 1.2	<p><u>Hydroperiods</u> (see p.73):                      Check the types of water regimes (hydroperiods) present within the wetland. The water regime has to cover more than 10% of the wetland or 1/4 acre to count (see text for descriptions of hydroperiods).</p> <p><input checked="" type="checkbox"/> Permanently flooded or inundated  <input checked="" type="checkbox"/> Seasonally flooded or inundated  <input type="checkbox"/> Occasionally flooded or inundated  <input type="checkbox"/> Saturated only  <input checked="" type="checkbox"/> Permanently flowing stream or river in, or adjacent to, the wetland  <input type="checkbox"/> Seasonally flowing stream in, or adjacent to, the wetland  <input type="checkbox"/> <b>Lake-fringe wetland..... = 2 points</b>  <input type="checkbox"/> <b>Freshwater tidal wetland..... = 2 points</b></p> <p style="text-align: right;"> <b>Map of hydroperiods</b>                      4 or more types present points = 3                      3 or more types present..... points = 2                      2 types present..... points = 1                      1 type present..... points = 0                 </p>	<p><b>Figure</b> ____</p> <p style="text-align: right;">2</p>
H 1.3	<p><u>Richness of Plant Species</u> (see p. 75):                      Count the number of plant species in the wetland that cover at least 10 ft<sup>2</sup> (different patches of the same species can be combined to meet the size threshold)                      You do not have to name the species. Do not include Eurasian Milfoil, reed canarygrass, purple loosestrife, Canadian Thistle.                      If you counted: &gt; 19 species..... points = 2                      5 – 19 species..... points = 1                      &lt; 5 species..... points = 0</p> <p>List species below if you want to:</p> <p>_____</p> <p>_____</p> <p>_____</p>	<p style="text-align: right;">1</p>
H 1.4	<p><u>Interspersion of Habitats</u> (see p. 76):                      Decided from the diagrams below whether interspersion between Cowardin vegetation (described in H1.1), or the classes and unvegetated areas (can include open water or mudflats) is high, medium, low, or none.</p> <div style="display: flex; justify-content: space-around;"> <div style="text-align: center;">  <p>None = 0 points</p> </div> <div style="text-align: center;">  <p>Low = 1 point</p> </div> <div style="text-align: center;">  <p>Moderate = 2 points</p> </div> </div> <div style="display: flex; justify-content: space-around; margin-top: 20px;"> <div style="text-align: center;">  <p>High = 3 points</p> </div> <div style="text-align: center;">  <p>High = 3 points</p> </div> <div style="text-align: center;">  <p>[riparian braided channels]</p> </div> </div> <p style="text-align: right;"> <b>Note:</b> If you have 4 or more classes or 3 vegetation classes and open water, the rating is always “high”.   <b>Use map of Cowardin classes.</b> </p>	<p><b>Figure</b> ____</p> <p style="text-align: right;">1</p>
H 1.5	<p><u>Special Habitat Features</u> (see p. 77):                      Check the habitat features that are present in the wetland. The number of checks is the number of points you put into the next column.</p> <p><input type="checkbox"/> Large, downed, woody debris within the wetland (&gt; 4 in. diameter and 6 ft. long)  <input checked="" type="checkbox"/> Standing snags (diameter at the bottom &gt; 4 inches) in the wetland  <input type="checkbox"/> Undercut banks are present for at least 6.6 ft. (2m) and/or overhanging vegetation extends at least 3.3 ft. (1m) over a stream (or ditch) in, or contiguous with the unit, for at least 33 ft. (10m)  <input type="checkbox"/> Stable steep banks of fine material that might be used by beaver or muskrat for denning (&gt; 30 degree slope) OR signs of recent beaver activity are present (cut shrubs or trees that have not yet turned grey/brown)  <input type="checkbox"/> At least 1/4 acre of thin-stemmed persistent vegetation or woody branches are present in areas that are permanently or seasonally inundated (structures for egg-laying by amphibians)  <input type="checkbox"/> Invasive plants cover less than 25% of the wetland area in each stratum of plants</p> <p><i>NOTE: The 20% stated in early printings of the manual on page 78 is an error.</i></p>	<p style="text-align: right;">1</p>
<p><b>H 1 TOTAL Score</b> – potential for providing habitat</p>		<p style="text-align: right;">6</p>

Exhibit 16  
SSDP2016-00415  
001141

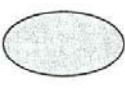
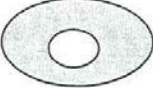

	<p>H 2.3 <u>Near or adjacent to other priority habitats listed by WDFW</u> (see p. 82): (see new and complete descriptions of WDFW priority habitats, and the counties in which they can be found, in the PHS report <a href="http://wdfw.wa.gov/hab/phslist.htm">http://wdfw.wa.gov/hab/phslist.htm</a> )</p> <p>Which of the following priority habitats are within 330 ft. (100m) of the wetland unit?  <i>NOTE: the connections do not have to be relatively undisturbed.</i></p> <p><input type="checkbox"/> <b>Aspen Stands:</b> Pure or mixed stands of aspen greater than 0.4 ha (1 acre).</p> <p><input type="checkbox"/> <b>Biodiversity Areas and Corridors:</b> Areas of habitat that are relatively important to various species of native fish and wildlife (full descriptions in WDFW PHS report p. 152).</p> <p><input type="checkbox"/> <b>Herbaceous Balds:</b> Variable size patches of grass and forbs on shallow soils over bedrock.</p> <p><input type="checkbox"/> <b>Old-growth/Mature forests:</b> (Old-growth west of Cascade crest) Stands of at least 2 tree species, forming a multi-layered canopy with occasional small openings; with at least 20 trees/ha (8 trees/acre) &gt; 81 cm (32 in) dbh or &gt; 200 years of age. (Mature forests) Stands with average diameters exceeding 53 cm (21 in) dbh; crown cover may be less than 100%; decay, decadence, numbers of snags, and quantity of large downed material is generally less than that found in old-growth; 80 - 200 years old west of the Cascade crest.</p> <p><input type="checkbox"/> <b>Oregon white Oak:</b> Woodlands Stands of pure oak or oak/conifer associations where canopy coverage of the oak component is important (full descriptions in WDFW PHS report p. 158).</p> <p><input checked="" type="checkbox"/> <b>Riparian:</b> The area adjacent to aquatic systems with flowing water that contains elements of both aquatic and terrestrial ecosystems which mutually influence each other.</p> <p><input type="checkbox"/> <b>Westside Prairies:</b> Herbaceous, non-forested plant communities that can either take the form of a dry prairie or a wet prairie (full descriptions in WDFW PHS report p. 161).</p> <p><input checked="" type="checkbox"/> <b>Instream:</b> The combination of physical, biological, and chemical processes and conditions that interact to provide functional life history requirements for instream fish and wildlife resources.</p> <p><input type="checkbox"/> <b>Nearshore:</b> Relatively undisturbed nearshore habitats. These include Coastal Nearshore, Open Coast Nearshore, and Puget Sound Nearshore. (full descriptions of habitats and the definition of relatively undisturbed are in WDFW report: pp. 167-169 and glossary in Appendix A).</p> <p><input type="checkbox"/> <b>Caves:</b> A naturally occurring cavity, recess, void, or system of interconnected passages under the earth in soils, rock, ice, or other geological formations and is large enough to contain a human.</p> <p><input type="checkbox"/> <b>Cliffs:</b> Greater than 7.6 m (25 ft) high and occurring below 5000 ft.</p> <p><input type="checkbox"/> <b>Talus:</b> Homogenous areas of rock rubble ranging in average size 0.15 - 2.0 m (0.5 - 6.5 ft), composed of basalt, andesite, and/or sedimentary rock, including riprap slides and mine tailings. May be associated with cliffs.</p> <p><input type="checkbox"/> <b>Snags and Logs:</b> Trees are considered snags if they are dead or dying and exhibit sufficient decay characteristics to enable cavity excavation/use by wildlife. Priority snags have a diameter at breast height of &gt; 51 cm (20 in) in western Washington and are &gt; 2 m (6.5 ft) in height. Priority logs are &gt; 30 cm (12 in) in diameter at the largest end, and &gt; 6 m (20 ft) long.</p> <p>If wetland has <b>3 or more</b> priority habitats = <b>4 points</b>  <b>If wetland has 2</b> priority habitats = <b>3 points</b>                  If wetland has <b>1</b> priority habitat = <b>1 point</b>                      No habitats = 0 points</p> <p>Note: All vegetated wetlands are by definition a priority habitat but are not included in this list. Nearby wetlands are addressed in question H 2.4)</p>	3
	<p>H 2.4 <u>Wetland Landscape:</u> Choose the <b>one</b> description of the landscape around the wetland that best fits (see p. 84)</p> <ul style="list-style-type: none"> <li>• There are at least 3 other wetlands within 1/2 mile, and the connections between them are relatively undisturbed (light grazing between wetlands OK, as is lake shore with some boating, but connections should NOT be bisected by paved roads, fill, fields, or other development.....points = 5</li> <li>• The wetland is Lake-fringe on a lake with little disturbance and there are 3 other lake-fringe wetlands within 1/2 mile .....points = 5</li> <li>• <b>There are at least 3 other wetlands within 1/2 mile, BUT the connections between them are disturbed.....points = 3</b></li> <li>• The wetland fringe on a lake <b>with</b> disturbance and there are 3 other lake-fringe wetlands within 1/2 mile .....points = 3</li> <li>• There is at least 1 wetland within 1/2 mile .....points = 2</li> <li>• There are no wetlands within 1/2 mile.....points = 0</li> </ul>	3
	<p><b>H 2 TOTAL Score</b> – opportunity for providing habitat                      Add the scores from H2.1, H2.2, H2.3, H2.4</p>	8
	<p style="text-align: right;"><i>TOTAL for H 1 from page 8</i></p>	6
◆	<p><b>Total Score for Habitat Functions</b>                      Add the points for H 1 and H 2; then <b>record the result on p. 1</b></p>	14

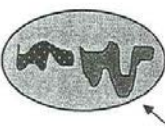
Comments:

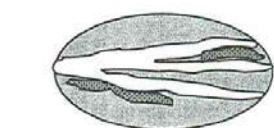

SC4	<p><b>Forested Wetlands</b> (see p. 90)</p> <p>Does the wetland have at least 1 acre of forest that meet one of these criteria for the Department of Fish and Wildlife's forests as priority habitats? <i>If you answer yes you will still need to rate the wetland based on its function.</i></p> <p>___ <b>Old-growth forests:</b> (west of Cascade Crest) Stands of at least two three species forming a multi-layered canopy with occasional small openings; with at least 8 trees/acre (20 trees/hectare) that are at least 200 years of age OR have a diameter at breast height (dbh) of 32 inches (81 cm or more).</p> <p>NOTE: The criterion for dbh is based on measurements for upland forests. Two-hundred year old trees in wetlands will often have a smaller dbh because their growth rates are often slower. The DFW criterion is and "OR" so old-growth forests do not necessarily have to have trees of this diameter.</p> <p>___ <b>Mature forests:</b> (west of the Cascade Crest) Stands where the largest trees are 80 – 200 years old OR have an average diameters (dbh) exceeding 21 inches (53 cm); crown cover may be less than 100%; decay, decadence, numbers of snags, and quantity of large downed material is generally less than that found in old-growth.</p> <p>YES = Category I                      NO = <u>X</u> not a forested wetland with special characteristics</p>	Cat. I
SC5	<p><b>Wetlands in Coastal Lagoons</b> (see p. 91)</p> <p>Does the wetland meet all of the following criteria of a wetland in a coastal lagoon?</p> <p>___ The wetland lies in a depression adjacent to marine waters that is wholly or partially separated from marine waters by sandbanks, gravel banks, shingle, or, less frequently, rocks.</p> <p>___ The lagoon in which the wetland is located contains surface water that is saline or brackish (&gt; 0.5 ppt) during most of the year in at least a portion of the lagoon (<i>needs to be measured near the bottom.</i>)</p> <p>YES = Go to SC 5.1                      NO <u>X</u> not a wetland in a coastal lagoon</p> <p>SC 5.1 Does the wetland meet all of the following three conditions?</p> <p>___ The wetland is relatively undisturbed (has no diking, ditching, filling, cultivation, grazing) and has less than 20% cover of invasive plant species (see list of invasive species on p. 74).</p> <p>___ At least 3/4 of the landward edge of the wetland has a 100 ft. buffer of shrub, forest, or un-grazed or un-mowed grassland.</p> <p>___ The wetland is larger than 1/10 acre (4350 square ft.)</p> <p>YES = Category I                      NO = Category II</p>	Cat. I Cat. II
SC6	<p><b>Interdunal Wetlands</b> (see p. 93)</p> <p>Is the wetland west of the 1889 line (also called the Western Boundary of Upland Ownership or WBUO)?</p> <p>YES = Go to SC 6.1                      NO <u>X</u> not an interdunal wetland for rating</p> <p><i>If you answer yes you will still need to rate the wetland based on its functions.</i></p> <p>In practical terms that means the following geographic areas:</p> <ul style="list-style-type: none"> <li>• Long Beach Peninsula -- lands west of SR 103</li> <li>• Grayland-Westport -- lands west of SR 105</li> <li>• Ocean Shores-Copalis – lands west of SR 115 and SR 109</li> </ul> <p>SC 6.1 Is the wetland one acre or larger, or is it in a mosaic of wetlands that is one acre or larger?</p> <p>YES = Category II                      NO = go to SC 6.2</p> <p>SC 6.2 Is the wetland between 0.1 and 1 acre, or is it in a mosaic of wetlands that is between 0.1 and 1 acre?</p> <p>YES = Category III</p>	Cat. II Cat. III
◆	<p><b>Category of wetland based on Special Characteristics</b></p> <p>Choose the "highest" rating if wetland falls into several categories, and record on p. 1.</p> <p>If you answered NO for all types enter "Not Applicable" on p. 1</p>	NA

Comments:

**Exhibit 16**  
**SSDP2016-00415**  
**001145**

Wetland name or number 25B

**WETLAND RATING FORM – WESTERN WASHINGTON**  
Version 2 – Updated July 2006 to increase accuracy and reproducibility among users  
Updated Oct. 2008 with the new WDFW definitions for priority habitats

Name of wetland (if known): 25B Date of site visit: 09-25-13

Rated by: Colin Worsley / Matt Maynard Trained by Ecology? Yes X No      Date of training: 11-2005 / 04-2006

SEC: 32 TOWNSHIP: 25N RANGE: 06E Is S/T/R in Appendix D? Yes      No X

Map of wetland unit: Figure                      Estimated size 0.33 acre

**SUMMARY OF RATING**

Category based on FUNCTIONS provided by wetland: I      II      III X IV     

Category I =	Score > 70
Category II =	Score 51 - 69
Category III =	Score 30 – 50
Category IV =	Score < 30

Score for Water Quality Functions	18
Score for Hydrologic Functions	10
Score for Habitat Functions	18
<b>TOTAL Score for Functions</b>	<b>46</b>

Category based on SPECIAL CHARACTERISTICS of Wetland I      II      Does not apply X

**Final Category** (choose the “highest” category from above”) **III**

**Summary of basic information about the wetland unit.**

Wetland Unit has Special Characteristics		Wetland HGM Class used for Rating	
<b>Estuarine</b>		<b>Depressional</b>	<b>X</b>
<b>Natural Heritage Wetland</b>		<b>Riverine</b>	
<b>Bog</b>		<b>Lake-fringe</b>	
<b>Mature Forest</b>		<b>Slope</b>	
<b>Old Growth Forest</b>		<b>Flats</b>	
<b>Coastal Lagoon</b>		<b>Freshwater Tidal</b>	
<b>Interdunal</b>			
None of the above	X	Check if unit has multiple HGM classes present	<span style="border: 1px solid black; padding: 2px 10px;">    </span>

**Does the wetland being rated meet any of the criteria below?** If you answer YES to any of the questions below you will need to protect the wetland according to the regulations regarding the special characteristics found in the wetland.

Check List for Wetlands that Need Additional Protection (in addition to the protection recommended for its category)	YES	NO
SP1. <i>Has the wetland unit been documented as a habitat for any Federally listed Threatened or Endangered <b>animal or plant</b> species (T/E species)?</i> For the purposes of this rating system, “documented” means the wetland is on the appropriate state or federal database.		X
SP2. <i>Has the wetland unit been documented as habitat for any State listed Threatened or Endangered <b>animal</b> species?</i> For the purposes of this rating system, “documented” means the wetland is on the appropriate state database. Note: Wetlands with State listed plant species are categorized as Category 1 Natural Heritage Wetlands (see p. 19 of data form).		X
SP3. <i>Does the wetland unit contain individuals of Priority species listed by the WDFW for the state?</i>		X
SP4. <i>Does the wetland unit have a local significance in addition to its functions?</i> For example, the wetland has been identified in the Shoreline Master Program, the Critical Areas Ordinance, or in a local management plan as having special significance.		X

To complete the next part of the data sheet you will need to determine the Hydrogeomorphic Class of the wetland being rated.

Exhibit 16  
SSDP2016-00415  
001146

### Classification of Vegetated Wetlands for Western Washington

If the hydrologic criteria listed in each question do not apply to the entire unit being rated, you probably have a unit with multiple HGM classes. In this case, identify which hydrologic criteria in questions 1-7 apply, and go to Question 8.

1. Are the water levels in the entire unit usually controlled by tides (i.e. except during floods)?  
NO – go to 2                      **YES – the wetland class is Tidal Fringe**  
 If yes, is the salinity of the water during periods of annual low flow below 0.5 ppt (parts per thousand)?  
**YES – Freshwater Tidal Fringe**                      **NO – Saltwater Tidal Fringe (Estuarine)**  
*If your wetland can be classified as a Freshwater Tidal Fringe use the forms for Riverine wetlands. If it is a Saltwater Tidal Fringe it is rated as an Estuarine wetland. Wetlands that were call estuarine in the first and second editions of the rating system are called Salt Water Tidal Fringe in the Hydrogeomorphic Classification. Estuarine wetlands were categorized separately in the earlier editions, and this separation is being kept in this revision. To maintain consistency between editions, the term “Estuarine” wetland is kept. Please note, however, that the characteristics that define Category I and II estuarine wetlands have changed (see p. \_\_\_\_\_).*

---

2. The entire wetland unit is flat and precipitation is only source (>90%) of water to it. Groundwater and surface water runoff are NOT sources of water to the unit.  
NO – go to 3                      **YES – The wetland class is Flats**  
 If your wetland can be classified as a “Flats” wetland, use the form for **Depressional** wetlands.

---

3. Does the entire wetland meet both of the following criteria?  
 \_\_\_\_\_ The vegetated part of the wetland is on the shores of a body of permanent open water (without any vegetation on the surface) where at least 20 acres (8ha) in size;  
 \_\_\_\_\_ At least 30% of the open water area is deeper than 6.6 (2 m)?  
NO – go to 4                      **YES – The wetland class is Lake-fringe (Lacustrine Fringe)**

---

4. Does the entire wetland meet all of the following criteria?  
 \_\_\_\_\_ The wetland is on a slope (*slope can be very gradual*).  
 \_\_\_\_\_ The water flows through the wetland in one direction (unidirectional) and usually comes from seeps. It may flow subsurface, as sheetflow, or in a swale without distinct banks.  
 \_\_\_\_\_ The water leaves the wetland **without being impounded**?  
 NOTE: *Surface water does not pond in these types of wetlands except occasionally in very small and shallow depressions or behind hummocks (depressions are usually <3 ft diameter and less than 1 foot deep).*  
NO – go to 5                      **YES – The wetland class is Slope**

---

5. Does the entire wetland meet all of the following criteria?  
 \_\_\_\_\_ The unit is in a valley or stream channel where it gets inundated by overbank flooding from that stream or river.  
 \_\_\_\_\_ The overbank flooding occurs at least once every two years.  
 NOTE: *The riverine unit can contain depressions that are filled with water when the river is not flooding..*  
NO – go to 6                      **YES – The wetland class is Riverine**

---

6. Is the entire wetland unit in a topographic depression in which water ponds, or is saturated to the surface, at some time of the year. This means that any outlet, if present is higher than the interior of the wetland.  
NO – go to 7                      **YES – The wetland class is Depressional**

---

7. Is the entire wetland located in a very flat area with no obvious depression and no overbank flooding. The unit does not pond surface water more than a few inches. The unit seems to be maintained by high groundwater in the area. The wetland may be ditched, but has no obvious natural outlet.  
No – go to 8                      **YES – The wetland class is Depressional**

---

8. Your wetland unit seems to be difficult to classify and probably contains several different HGM classes. For example, seeps at the base of a slope may grade into a riverine floodplain, or a small stream within a depressional wetland has a zone of flooding along its sides. **GO BACK AND IDENTIFY WHICH OF THE HYDROLOGIC REGIMES DESCRIBED IN QUESTIONS 1-7 APPLY TO DIFFERENT AREAS IN THE UNIT** (make a rough sketch to help you decide). Use the following table to identify the appropriate class to use for the rating system if you have several HGM classes present within your wetland. NOTE: Use this table only if the class that is recommended in the second column represents 10% or more of the total area of the wetland unit being rated. If the area of the class listed in column 2 is less than 10% of the unit, classify the wetland using the class that represents more than 90% of the total area.

HGM Classes within the wetland unit being rated	HGM Class to Use in Rating
Slope + Riverine	Riverine
Slope + Depressional	Depressional
Slope + Lake-fringe	Lake-fringe
Depressional + Riverine along stream within boundary	Depressional
Depressional + Lake-fringe	Depressional
Salt Water Tidal Fringe and any other class of freshwater wetland	Treat as ESTUARINE under wetlands with special characteristics

**Exhibit 16**  
**SSDP2016-00415**  
**001147**

If you are unable still to determine which of the above criteria apply to your wetland, or you have more than 2 HGM classes within a wetland boundary, classify the wetland as **Depressional** for the rating.





<b>D 4</b>	<p><b>Does the wetland have the <u>opportunity</u> to reduce flooding and erosion?</b></p> <p>Answer YES if the unit is in a location in the watershed where the flood storage, or reduction in water velocity, it provides helps protect downstream property and aquatic resources from flooding or excessive and/or erosive flows. Answer NO if the water coming into the wetland is controlled by a structure such as flood gate, tide gate, flap valve, reservoir etc. OR you estimate that more than 90% of the water in the wetland is from groundwater in areas where damaging groundwater flooding does not occur. <i>Note which of the following indicators of opportunity apply.</i></p> <p><input type="checkbox"/> Wetland is in a headwater of a river or stream that has flooding problems.</p> <p><input checked="" type="checkbox"/> Wetland drains to a river or stream that has flooding problems</p> <p><input type="checkbox"/> Wetland has no outlet and impounds surface runoff water that might otherwise flow into a river or stream that has flooding problems</p> <p><input type="checkbox"/> Other _____</p> <p><b>YES multiplier is 2</b>                      NO multiplier is 1</p>	<p>(see p. 49)</p> <p>Multiplier</p> <p><u>X2</u></p>
◆	<p><b>TOTAL – Hydrologic Functions</b>                      Multiply the score from D3 by D4; then <i>add score to table on p. 1</i></p>	<p>10</p>

Comments:





<p><i>These questions apply to wetlands of all HGM classes.</i></p> <p>HABITAT FUNCTIONS – Indicators that wetland functions to provide important habitat.</p>		<p><b>Points</b> (only 1 score per box)</p>
<b>H 1</b>	<b>Does the wetland have the <u>potential</u> to provide habitat for many species?</b>	
H 1.1	<p><u>Vegetation structure</u> (see P. 72):                      Check the types of vegetation classes present (as defined by Cowardin) – Size threshold for each class is 1/4 acre or more than 10% of the area if unit is smaller than 2.5 acres.</p> <p><input type="checkbox"/> Aquatic Bed  <input checked="" type="checkbox"/> Emergent plants  <input checked="" type="checkbox"/> Scrub/shrub (areas where shrubs have &gt; 30% cover)  <input checked="" type="checkbox"/> Forested (areas where trees have &gt; 30% cover)                      If the unit has a forested class check if:  <input type="checkbox"/> The forested class has 3 out of 5 strata (canopy, sub-canopy, shrubs, herbaceous, moss/ground-cover) that each cover 20% within the forested polygon.                      Add the number of vegetation types that qualify. If you have:</p> <p style="text-align: right;"> <b>Map of Cowardin vegetation classes</b>                      4 structures or more..... points = 4                      3 structures..... points = 2                      2 structures..... points = 1                      1 structure ..... points = 0                 </p>	<p><b>Figure</b> ____</p> <p style="text-align: right;">2</p>
H 1.2	<p><u>Hydroperiods</u> (see p.73):                      Check the types of water regimes (hydroperiods) present within the wetland. The water regime has to cover more than 10% of the wetland or 1/4 acre to count (see text for descriptions of hydroperiods).</p> <p><input type="checkbox"/> Permanently flooded or inundated  <input checked="" type="checkbox"/> Seasonally flooded or inundated  <input checked="" type="checkbox"/> Occasionally flooded or inundated  <input checked="" type="checkbox"/> Saturated only</p> <p><input type="checkbox"/> Permanently flowing stream or river in, or adjacent to, the wetland  <input type="checkbox"/> Seasonally flowing stream in, or adjacent to, the wetland  <input type="checkbox"/> <b>Lake-fringe wetland..... = 2 points</b>  <input type="checkbox"/> <b>Freshwater tidal wetland..... = 2 points</b></p> <p style="text-align: right;"> <b>Map of hydroperiods</b>                      4 or more types present points = 3                      3 or more types present..... points = 2                      2 types present..... points = 1                      1 type present ..... points = 0                 </p>	<p><b>Figure</b> ____</p> <p style="text-align: right;">2</p>
H 1.3	<p><u>Richness of Plant Species</u> (see p. 75):                      Count the number of plant species in the wetland that cover at least 10 ft<sup>2</sup> (different patches of the same species can be combined to meet the size threshold)                      You do not have to name the species. Do not include Eurasian Milfoil, reed canarygrass, purple loosestrife, Canadian Thistle.</p> <p>If you counted: &gt; 19 species ..... points = 2                      5 – 19 species..... points = 1                      &lt; 5 species ..... points = 0</p> <p>List species below if you want to:</p> <p>_____</p> <p>_____</p> <p>_____</p>	<p style="text-align: right;">1</p>
H 1.4	<p><u>Interspersion of Habitats</u> (see p. 76):                      Decided from the diagrams below whether interspersion between Cowardin vegetation (described in H1.1), or the classes and unvegetated areas (can include open water or mudflats) is high, medium, low, or none.</p> <div style="display: flex; justify-content: space-around;"> <div style="text-align: center;">                           None = 0 points                     </div> <div style="text-align: center;">                           Low = 1 point                     </div> <div style="text-align: center;">                           Moderate = 2 points                     </div> </div> <div style="display: flex; justify-content: space-around; margin-top: 10px;"> <div style="text-align: center;">                           High = 3 points                     </div> <div style="text-align: center;">                           High = 3 points                     </div> <div style="text-align: center;">                           [riparian braided channels]                     </div> </div> <div style="margin-top: 10px;"> <p>Note: If you have 4 or more classes or 3 vegetation classes and open water, the rating is always “high”.</p> <p><b>Use map of Cowardin classes.</b></p> </div>	<p><b>Figure</b> ____</p> <p style="text-align: right;">3</p>
H 1.5	<p><u>Special Habitat Features</u> (see p. 77):                      Check the habitat features that are present in the wetland. The number of checks is the number of points you put into the next column.</p> <p><input checked="" type="checkbox"/> Large, downed, woody debris within the wetland (&gt; 4 in. diameter and 6 ft. long)  <input type="checkbox"/> Standing snags (diameter at the bottom &gt; 4 inches) in the wetland  <input type="checkbox"/> Undercut banks are present for at least 6.6 ft. (2m) and/or overhanging vegetation extends at least 3.3 ft. (1m) over a stream (or ditch) in, or contiguous with the unit, for at least 33 ft. (10m)  <input type="checkbox"/> Stable steep banks of fine material that might be used by beaver or muskrat for denning (&gt; 30 degree slope) OR signs of recent beaver activity are present (cut shrubs or trees that have not yet turned grey/brown)  <input type="checkbox"/> At least 1/4 acre of thin-stemmed persistent vegetation or woody branches are present in areas that are permanently or seasonally inundated (structures for egg-laying by amphibians)  <input type="checkbox"/> Invasive plants cover less than 25% of the wetland area in each stratum of plants</p> <p><i>NOTE: The 20% stated in early printings of the manual on page 78 is an error.</i></p>	<p style="text-align: right;">1</p>
<p><b>H 1 TOTAL Score</b> – potential for providing habitat</p>		<p style="text-align: right;">9</p>

Exhibit 16  
SSDP2016-00415  
001150

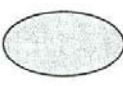
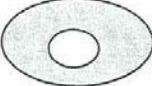

	<p>H 2.3 <u>Near or adjacent to other priority habitats listed by WDFW</u> (see p. 82): (see new and complete descriptions of WDFW priority habitats, and the counties in which they can be found, in the PHS report <a href="http://wdfw.wa.gov/hab/phslist.htm">http://wdfw.wa.gov/hab/phslist.htm</a> )</p> <p>Which of the following priority habitats are within 330 ft. (100m) of the wetland unit?  <i>NOTE: the connections do not have to be relatively undisturbed.</i></p> <p><input type="checkbox"/> <b>Aspen Stands:</b> Pure or mixed stands of aspen greater than 0.4 ha (1 acre).</p> <p><input type="checkbox"/> <b>Biodiversity Areas and Corridors:</b> Areas of habitat that are relatively important to various species of native fish and wildlife (full descriptions in WDFW PHS report p. 152).</p> <p><input type="checkbox"/> <b>Herbaceous Balds:</b> Variable size patches of grass and forbs on shallow soils over bedrock.</p> <p><input type="checkbox"/> <b>Old-growth/Mature forests:</b> (Old-growth west of Cascade crest) Stands of at least 2 tree species, forming a multi-layered canopy with occasional small openings; with at least 20 trees/ha (8 trees/acre) &gt; 81 cm (32 in) dbh or &gt; 200 years of age. (Mature forests) Stands with average diameters exceeding 53 cm (21 in) dbh; crown cover may be less than 100%; decay, decadence, numbers of snags, and quantity of large downed material is generally less than that found in old-growth; 80 - 200 years old west of the Cascade crest.</p> <p><input type="checkbox"/> <b>Oregon white Oak:</b> Woodlands Stands of pure oak or oak/conifer associations where canopy coverage of the oak component is important (full descriptions in WDFW PHS report p. 158).</p> <p><input checked="" type="checkbox"/> <b>Riparian:</b> The area adjacent to aquatic systems with flowing water that contains elements of both aquatic and terrestrial ecosystems which mutually influence each other.</p> <p><input type="checkbox"/> <b>Westside Prairies:</b> Herbaceous, non-forested plant communities that can either take the form of a dry prairie or a wet prairie (full descriptions in WDFW PHS report p. 161).</p> <p><input checked="" type="checkbox"/> <b>Instream:</b> The combination of physical, biological, and chemical processes and conditions that interact to provide functional life history requirements for instream fish and wildlife resources.</p> <p><input type="checkbox"/> <b>Nearshore:</b> Relatively undisturbed nearshore habitats. These include Coastal Nearshore, Open Coast Nearshore, and Puget Sound Nearshore. (full descriptions of habitats and the definition of relatively undisturbed are in WDFW report: pp. 167-169 and glossary in Appendix A).</p> <p><input type="checkbox"/> <b>Caves:</b> A naturally occurring cavity, recess, void, or system of interconnected passages under the earth in soils, rock, ice, or other geological formations and is large enough to contain a human.</p> <p><input type="checkbox"/> <b>Cliffs:</b> Greater than 7.6 m (25 ft) high and occurring below 5000 ft.</p> <p><input type="checkbox"/> <b>Talus:</b> Homogenous areas of rock rubble ranging in average size 0.15 - 2.0 m (0.5 - 6.5 ft), composed of basalt, andesite, and/or sedimentary rock, including riprap slides and mine tailings. May be associated with cliffs.</p> <p><input checked="" type="checkbox"/> <b>Snags and Logs:</b> Trees are considered snags if they are dead or dying and exhibit sufficient decay characteristics to enable cavity excavation/use by wildlife. Priority snags have a diameter at breast height of &gt; 51 cm (20 in) in western Washington and are &gt; 2 m (6.5 ft) in height. Priority logs are &gt; 30 cm (12 in) in diameter at the largest end, and &gt; 6 m (20 ft) long.</p> <p><b>If wetland has 3 or more priority habitats = 4 points</b>  <b>If wetland has 2 priority habitats = 3 points</b>  <b>If wetland has 1 priority habitat = 1 point</b>                      No habitats = 0 points</p> <p>Note: All vegetated wetlands are by definition a priority habitat but are not included in this list. Nearby wetlands are addressed in question H 2.4)</p>	4
	<p>H 2.4 <u>Wetland Landscape:</u> Choose the <b>one</b> description of the landscape around the wetland that best fits (see p. 84)</p> <ul style="list-style-type: none"> <li>• There are at least 3 other wetlands within 1/2 mile, and the connections between them are relatively undisturbed (light grazing between wetlands OK, as is lake shore with some boating, but connections should NOT be bisected by paved roads, fill, fields, or other development.....points = 5</li> <li>• The wetland is Lake-fringe on a lake with little disturbance and there are 3 other lake-fringe wetlands within 1/2 mile .....points = 5</li> <li>• <b>There are at least 3 other wetlands within 1/2 mile, BUT the connections between them are disturbed.....points = 3</b></li> <li>• The wetland fringe on a lake <b>with</b> disturbance and there are 3 other lake-fringe wetlands within 1/2 mile .....points = 3</li> <li>• There is at least 1 wetland within 1/2 mile .....points = 2</li> <li>• There are no wetlands within 1/2 mile.....points = 0</li> </ul>	3
	<p><b>H 2 TOTAL Score – opportunity for providing habitat</b>                      Add the scores from H2.1, H2.2, H2.3, H2.4</p>	9
	<p style="text-align: right;"><i>TOTAL for H 1 from page 8</i></p>	9
◆	<p><b>Total Score for Habitat Functions</b>                      Add the points for H 1 and H 2; then <b>record the result on p. 1</b></p>	18

Comments:

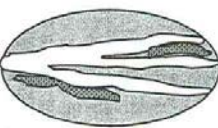

SC4	<p><b>Forested Wetlands</b> (see p. 90)</p> <p>Does the wetland have at least 1 acre of forest that meet one of these criteria for the Department of Fish and Wildlife's forests as priority habitats? <i>If you answer yes you will still need to rate the wetland based on its function.</i></p> <p>___ <b>Old-growth forests:</b> (west of Cascade Crest) Stands of at least two three species forming a multi-layered canopy with occasional small openings; with at least 8 trees/acre (20 trees/hectare) that are at least 200 years of age OR have a diameter at breast height (dbh) of 32 inches (81 cm or more).</p> <p>NOTE: The criterion for dbh is based on measurements for upland forests. Two-hundred year old trees in wetlands will often have a smaller dbh because their growth rates are often slower. The DFW criterion is and "OR" so old-growth forests do not necessarily have to have trees of this diameter.</p> <p>___ <b>Mature forests:</b> (west of the Cascade Crest) Stands where the largest trees are 80 – 200 years old OR have an average diameters (dbh) exceeding 21 inches (53 cm); crown cover may be less than 100%; decay, decadence, numbers of snags, and quantity of large downed material is generally less than that found in old-growth.</p> <p>YES = Category I                      NO = <u>X</u> not a forested wetland with special characteristics</p>	Cat. I
SC5	<p><b>Wetlands in Coastal Lagoons</b> (see p. 91)</p> <p>Does the wetland meet all of the following criteria of a wetland in a coastal lagoon?</p> <p>___ The wetland lies in a depression adjacent to marine waters that is wholly or partially separated from marine waters by sandbanks, gravel banks, shingle, or, less frequently, rocks.</p> <p>___ The lagoon in which the wetland is located contains surface water that is saline or brackish (&gt; 0.5 ppt) during most of the year in at least a portion of the lagoon (<i>needs to be measured near the bottom.</i>)</p> <p>YES = Go to SC 5.1                      NO <u>X</u> not a wetland in a coastal lagoon</p> <p>SC 5.1 Does the wetland meet all of the following three conditions?</p> <p>___ The wetland is relatively undisturbed (has no diking, ditching, filling, cultivation, grazing) and has less than 20% cover of invasive plant species (see list of invasive species on p. 74).</p> <p>___ At least 3/4 of the landward edge of the wetland has a 100 ft. buffer of shrub, forest, or un-grazed or un-mowed grassland.</p> <p>___ The wetland is larger than 1/10 acre (4350 square ft.)</p> <p>YES = Category I                      NO = Category II</p>	Cat. I Cat. II
SC6	<p><b>Interdunal Wetlands</b> (see p. 93)</p> <p>Is the wetland west of the 1889 line (also called the Western Boundary of Upland Ownership or WBUO)?</p> <p>YES = Go to SC 6.1                      NO <u>X</u> not an interdunal wetland for rating</p> <p><b><i>If you answer yes you will still need to rate the wetland based on its functions.</i></b></p> <p>In practical terms that means the following geographic areas:</p> <ul style="list-style-type: none"> <li>• Long Beach Peninsula -- lands west of SR 103</li> <li>• Grayland-Westport -- lands west of SR 105</li> <li>• Ocean Shores-Copalis – lands west of SR 115 and SR 109</li> </ul> <p>SC 6.1 Is the wetland one acre or larger, or is it in a mosaic of wetlands that is one acre or larger?</p> <p>YES = Category II                      NO = go to SC 6.2</p> <p>SC 6.2 Is the wetland between 0.1 and 1 acre, or is it in a mosaic of wetlands that is between 0.1 and 1 acre?</p> <p>YES = Category III</p>	Cat. II Cat. III
◆	<p><b>Category of wetland based on Special Characteristics</b></p> <p><i>Choose the "highest" rating if wetland falls into several categories, and record on p. 1.</i></p> <p>If you answered NO for all types enter "Not Applicable" on p. 1</p>	NA

Comments:

**Exhibit 16**  
**SSDP2016-00415**  
**001154**

Wetland name or number 25C

**WETLAND RATING FORM – WESTERN WASHINGTON**  
Version 2 – Updated July 2006 to increase accuracy and reproducibility among users  
Updated Oct. 2008 with the new WDFW definitions for priority habitats

Name of wetland (if known): 25C Date of site visit: 09-25-13

Rated by: Colin Worsley / Matt Maynard Trained by Ecology? Yes X No      Date of training: 11-2005 / 04-2006

SEC: 32 TOWNSHIP: 25N RANGE: 06E Is S/T/R in Appendix D? Yes      No X

Map of wetland unit: Figure                      Estimated size 0.33 acre

**SUMMARY OF RATING**

Category based on FUNCTIONS provided by wetland: I      II      III X IV     

Category I =	Score > 70
Category II =	Score 51 - 69
Category III =	Score 30 – 50
Category IV =	Score < 30

Score for Water Quality Functions	14
Score for Hydrologic Functions	14
Score for Habitat Functions	14
<b>TOTAL Score for Functions</b>	<b>42</b>

Category based on SPECIAL CHARACTERISTICS of Wetland I      II      Does not apply X

**Final Category** (choose the “highest” category from above”) **III**

**Summary of basic information about the wetland unit.**

Wetland Unit has Special Characteristics		Wetland HGM Class used for Rating	
<b>Estuarine</b>		<b>Depressional</b>	<b>X</b>
<b>Natural Heritage Wetland</b>		<b>Riverine</b>	
<b>Bog</b>		<b>Lake-fringe</b>	
<b>Mature Forest</b>		<b>Slope</b>	
<b>Old Growth Forest</b>		<b>Flats</b>	
<b>Coastal Lagoon</b>		<b>Freshwater Tidal</b>	
<b>Interdunal</b>			
None of the above	X	Check if unit has multiple HGM classes present	<span style="border: 1px solid black; padding: 2px 10px;">    </span>

**Does the wetland being rated meet any of the criteria below?** If you answer YES to any of the questions below you will need to protect the wetland according to the regulations regarding the special characteristics found in the wetland.

Check List for Wetlands that Need Additional Protection (in addition to the protection recommended for its category)	YES	NO
SP1. <i>Has the wetland unit been documented as a habitat for any Federally listed Threatened or Endangered <b>animal or plant</b> species (T/E species)?</i> For the purposes of this rating system, “documented” means the wetland is on the appropriate state or federal database.		X
SP2. <i>Has the wetland unit been documented as habitat for any State listed Threatened or Endangered <b>animal</b> species?</i> For the purposes of this rating system, “documented” means the wetland is on the appropriate state database. Note: Wetlands with State listed plant species are categorized as Category 1 Natural Heritage Wetlands (see p. 19 of data form).		X
SP3. <i>Does the wetland unit contain individuals of Priority species listed by the WDFW for the state?</i>		X
SP4. <i>Does the wetland unit have a local significance in addition to its functions?</i> For example, the wetland has been identified in the Shoreline Master Program, the Critical Areas Ordinance, or in a local management plan as having special significance.		X

To complete the next part of the data sheet you will need to determine the Hydrogeomorphic Class of the wetland being rated. Exhibit 16

SSDP2016-00415

The hydrogeomorphic classification groups wetlands in to those that function in similar ways. This simplifies the questions needed to answer how well the wetland functions. The Hydrogeomorphic Class of a wetland can be determined using the key below. See p. 24 for more detailed instructions on classifying wetlands.



### Classification of Vegetated Wetlands for Western Washington

If the hydrologic criteria listed in each question do not apply to the entire unit being rated, you probably have a unit with multiple HGM classes. In this case, identify which hydrologic criteria in questions 1-7 apply, and go to Question 8.

1. Are the water levels in the entire unit usually controlled by tides (i.e. except during floods)?

**NO – go to 2**

**YES – the wetland class is Tidal Fringe**

If yes, is the salinity of the water during periods of annual low flow below 0.5 ppt (parts per thousand)?

**YES – Freshwater Tidal Fringe**

**NO – Saltwater Tidal Fringe (Estuarine)**

If your wetland can be classified as a Freshwater Tidal Fringe use the forms for **Riverine** wetlands. If it is a Saltwater Tidal Fringe it is rated as an **Estuarine** wetland. Wetlands that were called estuarine in the first and second editions of the rating system are called Salt Water Tidal Fringe in the Hydrogeomorphic Classification. Estuarine wetlands were categorized separately in the earlier editions, and this separation is being kept in this revision. To maintain consistency between editions, the term “Estuarine” wetland is kept. Please note, however, that the characteristics that define Category I and II estuarine wetlands have changed (see p. \_\_\_\_\_).

2. The entire wetland unit is flat and precipitation is only source (>90%) of water to it. Groundwater and surface water runoff are NOT sources of water to the unit.

**NO – go to 3**

**YES – The wetland class is Flats**

If your wetland can be classified as a “Flats” wetland, use the form for **Depressional** wetlands.

3. Does the entire wetland meet both of the following criteria?

\_\_\_\_\_ The vegetated part of the wetland is on the shores of a body of permanent open water (without any vegetation on the surface) where at least 20 acres (8ha) in size;

\_\_\_\_\_ At least 30% of the open water area is deeper than 6.6 (2 m)?

**NO – go to 4**

**YES – The wetland class is Lake-fringe (Lacustrine Fringe)**

4. Does the entire wetland meet all of the following criteria?

\_\_\_\_\_ The wetland is on a slope (*slope can be very gradual*).

\_\_\_\_\_ The water flows through the wetland in one direction (unidirectional) and usually comes from seeps. It may flow subsurface, as sheetflow, or in a swale without distinct banks.

\_\_\_\_\_ The water leaves the wetland **without being impounded**?

NOTE: *Surface water does not pond in these types of wetlands except occasionally in very small and shallow depressions or behind hummocks (depressions are usually <3 ft diameter and less than 1 foot deep).*

**NO – go to 5**

**YES – The wetland class is Slope**

5. Does the entire wetland meet all of the following criteria?

\_\_\_\_\_ The unit is in a valley or stream channel where it gets inundated by overbank flooding from that stream or river.

\_\_\_\_\_ The overbank flooding occurs at least once every two years.

NOTE: *The riverine unit can contain depressions that are filled with water when the river is not flooding..*

**NO – go to 6**

**YES – The wetland class is Riverine**

6. Is the entire wetland unit in a topographic depression in which water ponds, or is saturated to the surface, at some time of the year. This means that any outlet, if present is higher than the interior of the wetland.

**NO – go to 7**

**YES – The wetland class is Depressional**

7. Is the entire wetland located in a very flat area with no obvious depression and no overbank flooding. The unit does not pond surface water more than a few inches. The unit seems to be maintained by high groundwater in the area. The wetland may be ditched, but has no obvious natural outlet.

**No – go to 8**

**YES – The wetland class is Depressional**

8. Your wetland unit seems to be difficult to classify and probably contains several different HGM classes. For example, seeps at the base of a slope may grade into a riverine floodplain, or a small stream within a depressional wetland has a zone of flooding along its sides. GO BACK AND IDENTIFY WHICH OF THE HYDROLOGIC REGIMES DESCRIBED IN QUESTIONS 1-7 APPLY TO DIFFERENT AREAS IN THE UNIT (make a rough sketch to help you decide). Use the following table to identify the appropriate class to use for the rating system if you have several HGM classes present within your wetland. NOTE: Use this table only if the class that is recommended in the second column represents 10% or more of the total area of the wetland unit being rated. If the area of the class listed in column 2 is less than 10% of the unit, classify the wetland using the class that represents more than 90% of the total area.

HGM Classes within the wetland unit being rated	HGM Class to Use in Rating
Slope + Riverine	Riverine
Slope + Depressional	Depressional
Slope + Lake-fringe	Lake-fringe
Depressional + Riverine along stream within boundary	Depressional
Depressional + Lake-fringe	Depressional
Salt Water Tidal Fringe and any other class of freshwater wetland	Treat as ESTUARINE under wetlands with special characteristics

If you are unable still to determine which of the above criteria apply to your wetland, or you have more than 2 HGM classes within a wetland boundary, classify the wetland as **Depressional** for the rating.

<b>D Depressional and Flat Wetlands</b>		<b>Points</b>
WATER QUALITY FUNCTIONS – Indicators that wetland functions to improve water quality.		(only 1 score per box) (see p.38)
<b>D 1</b>	<b>Does the wetland have the <u>potential</u> to improve water quality?</b>	
D 1.1	Characteristics of surface water flows out of the wetland: • Unit is a depression with no surface water leaving it (no outlet)..... points = 3 • <b>Unit has an intermittently flowing, OR highly constricted, permanently flowing outlet ..... points = 2</b> • Unit has an unconstricted, or slightly constricted, surface outlet ( <i>permanently flowing</i> ) ..... points = 1 • Unit is a “flat” depression (Q.7 on key), or in the Flats class, with permanent surface outflow <b>and no obvious natural outlet</b> and/or outlet is a man-made ditch..... points = 1 ( <i>If ditch is not permanently flowing treat unit as “intermittently flowing”</i> ) <b>Provide photo or drawing</b>	<b>Figure</b> ____  2
D 1.2	The soil 2 inches below the surface (or duff layer) is clay or organic ( <i>use NRCS definitions</i> ) YES points = 4 NO points = 0	0
D 1.3	Characteristics of persistent vegetation (emergent, shrub, and/or forest Cowardin class): • <b>Wetland has persistent, ungrazed vegetation &gt;= 95% of area..... points = 5</b> • Wetland has persistent, ungrazed vegetation >= 1/2 of area..... points = 3 • Wetland has persistent, ungrazed vegetation >= 1/10 of area..... points = 1 • Wetland has persistent, ungrazed vegetation < 1/10 of area..... points = 0 <p style="text-align: center;"><b>Map of Cowardin vegetation classes</b></p>	<b>Figure</b> ____  5
D 1.4	Characteristics of seasonal ponding or inundation: <i>This is the area of the wetland that is ponded for at least 2 months, but dries out sometime during the year. Do not count the area that is permanently ponded. Estimate area as the average condition 5 out of 10 years.</i> • Area seasonally ponded is > 1/2 total area of wetland ..... points = 4 • Area seasonally ponded is > 1/4 total area of wetland ..... points = 2 • <b>Area seasonally ponded is &lt; 1/4 total area of wetland ..... points = 0</b> <p style="text-align: center;"><b>Map of Hydroperiods</b></p>	<b>Figure</b> ____  0
<b>Total for D 1</b>		<i>Add the points in the boxes above</i> <b>7</b>
<b>D 2</b>	<b>Does the wetland have the <u>opportunity</u> to improve water quality?</b>	(see p. 44)
Answer YES if you know or believe there are pollutants in groundwater or surface water coming into the wetland that would otherwise reduce water quality in streams, lakes or groundwater downgradient from the wetland? <i>Note which of the following conditions provide the sources of pollutants. A unit may have pollutants coming from several sources, but any single source would qualify as opportunity.</i> <input type="checkbox"/> Grazing in the wetland or within 150 ft <input type="checkbox"/> Untreated stormwater discharges to wetland <input type="checkbox"/> Tilled fields or orchards within 150 ft. of wetland <input type="checkbox"/> A stream or culvert discharges into wetland that drains developed areas, residential areas, farmed fields, roads, or clear-cut logging <input checked="" type="checkbox"/> Residential, urban areas, golf courses are within 150 ft. of wetland <input type="checkbox"/> Wetland is fed by groundwater high in phosphorus or nitrogen <input type="checkbox"/> Other _____		Multiplier  <u>X2</u>
<input checked="" type="checkbox"/> YES multiplier is 2 <input type="checkbox"/> NO multiplier is 1		
<b>◆ TOTAL – Water Quality Functions</b>		14
HYDROLOGIC FUNCTIONS – Indicators that wetland unit functions to reduce flooding and stream degradation.		
<b>D 3</b>	<b>Does the wetland have the <u>potential</u> to reduce flooding and erosion?</b>	(see p.46)
D 3.1	Characteristics of surface water flows out of the wetland unit • Unit is a depression with no surface water leaving it (no outlet)..... points = 4 • <b>Unit has an intermittently flowing, OR highly constricted permanently flowing outlet ..... points = 2</b> • Unit is a “flat” depression (Q.7 on key) or in the Flats class, with permanent surface outflow <b>and no obvious natural outlet</b> and/or outlet is a man-made ditch..... points = 1 ( <i>If ditch is not permanently flowing treat unit as “intermittently flowing”</i> ) • Unit has an unconstricted, or slightly constricted, surface outlet ( <i>permanently flowing</i> ) ..... points = 0	2
D 3.2	Depth of storage during wet periods. <i>Estimate the height of ponding above the bottom of the outlet. For units with no outlet measure from the surface of permanent water or deepest part (if dry).</i> • Marks of ponding are 3 ft. or more above the surface or bottom of the outlet ..... points = 7 • The wetland is a “headwater” wetland..... points = 5 • Marks of ponding between 2 ft. to < 3 ft. from surface or bottom of outlet ..... points = 5 • Marks are at least 0.5 ft. to < 2 ft. from surface or bottom of outlet ..... points = 3 • Wetland is flat (yes to Q.2 or Q.7 on key)but has small depressions on the surface that trap water points = 1 • <b>Marks of ponding less than 0.5 ft ..... points = 0</b>	0
D 3.3	Contribution of wetland unit to storage in the watershed: <i>Estimate the ratio of the area of upstream basin contributing surface water to the wetland to the area of the wetland unit itself.</i> • <b>The area of the basin is less than 10 times the area of unit..... points = 5</b> • The area of the basin is 10 to 100 times the area of the unit ..... points = 3 • The area of the basin is more than 100 times the area of the unit ..... points = 0 • Entire unit is in the FLATS class ..... points = 5	5
<b>Total for D 3</b>		<i>Add the points in the boxes above</i> <b>7</b>

**Exhibit 16**  
**SSDP2016-00415**  
**001157**

<b>D 4</b>	<p><b>Does the wetland have the <u>opportunity</u> to reduce flooding and erosion?</b></p> <p>Answer YES if the unit is in a location in the watershed where the flood storage, or reduction in water velocity, it provides helps protect downstream property and aquatic resources from flooding or excessive and/or erosive flows. Answer NO if the water coming into the wetland is controlled by a structure such as flood gate, tide gate, flap valve, reservoir etc. OR you estimate that more than 90% of the water in the wetland is from groundwater in areas where damaging groundwater flooding does not occur. <i>Note which of the following indicators of opportunity apply.</i></p> <p><input type="checkbox"/> Wetland is in a headwater of a river or stream that has flooding problems.</p> <p><input checked="" type="checkbox"/> Wetland drains to a river or stream that has flooding problems</p> <p><input type="checkbox"/> Wetland has no outlet and impounds surface runoff water that might otherwise flow into a river or stream that has flooding problems</p> <p><input type="checkbox"/> Other _____</p> <p><b>YES multiplier is 2</b>                      NO multiplier is 1</p>	<p>(see p. 49)</p> <p>Multiplier</p> <p><u>X2</u></p>
◆	<p><b>TOTAL – Hydrologic Functions</b>                      Multiply the score from D3 by D4; then <i>add score to table on p. 1</i></p>	<p>14</p>

Comments:





<p><i>These questions apply to wetlands of all HGM classes.</i></p> <p>HABITAT FUNCTIONS – Indicators that wetland functions to provide important habitat.</p>		<p><b>Points</b> (only 1 score per box)</p>
<b>H 1</b>	<b>Does the wetland have the <u>potential</u> to provide habitat for many species?</b>	
H 1.1	<p><u>Vegetation structure</u> (see P. 72):                      Check the types of vegetation classes present (as defined by Cowardin) – Size threshold for each class is 1/4 acre or more than 10% of the area if unit is smaller than 2.5 acres.</p> <p><input type="checkbox"/> Aquatic Bed  <input checked="" type="checkbox"/> Emergent plants  <input type="checkbox"/> Scrub/shrub (areas where shrubs have &gt; 30% cover)  <input checked="" type="checkbox"/> Forested (areas where trees have &gt; 30% cover)                      If the unit has a forested class check if:  <input checked="" type="checkbox"/> The forested class has 3 out of 5 strata (canopy, sub-canopy, shrubs, herbaceous, moss/ground-cover) that each cover 20% within the forested polygon.                      Add the number of vegetation types that qualify. If you have:</p> <p style="text-align: right;"> <b>Map of Cowardin vegetation classes</b>                      4 structures or more..... points = 4                      3 structures..... points = 2                      2 structures..... points = 1                      1 structure ..... points = 0                 </p>	<p><b>Figure</b> ____</p> <p style="text-align: right;">2</p>
H 1.2	<p><u>Hydroperiods</u> (see p.73):                      Check the types of water regimes (hydroperiods) present within the wetland. The water regime has to cover more than 10% of the wetland or 1/4 acre to count (see text for descriptions of hydroperiods).</p> <p><input type="checkbox"/> Permanently flooded or inundated  <input checked="" type="checkbox"/> Seasonally flooded or inundated  <input type="checkbox"/> Occasionally flooded or inundated  <input checked="" type="checkbox"/> Saturated only</p> <p><input type="checkbox"/> Permanently flowing stream or river in, or adjacent to, the wetland  <input type="checkbox"/> Seasonally flowing stream in, or adjacent to, the wetland  <input type="checkbox"/> <b>Lake-fringe wetland..... = 2 points</b>  <input type="checkbox"/> <b>Freshwater tidal wetland..... = 2 points</b></p> <p style="text-align: right;"> <b>Map of hydroperiods</b>                      4 or more types present points = 3                      3 or more types present..... points = 2                      2 types present..... points = 1                      1 type present ..... points = 0                 </p>	<p><b>Figure</b> ____</p> <p style="text-align: right;">1</p>
H 1.3	<p><u>Richness of Plant Species</u> (see p. 75):                      Count the number of plant species in the wetland that cover at least 10 ft<sup>2</sup> (different patches of the same species can be combined to meet the size threshold)                      You do not have to name the species. Do not include Eurasian Milfoil, reed canarygrass, purple loosestrife, Canadian Thistle.</p> <p style="text-align: right;">                     If you counted: &gt; 19 species ..... points = 2                      5 – 19 species..... points = 1                      &lt; 5 species ..... points = 0                 </p> <p>List species below if you want to:</p> <p>_____</p> <p>_____</p> <p>_____</p>	<p style="text-align: right;">1</p>
H 1.4	<p><u>Interspersion of Habitats</u> (see p. 76):                      Decided from the diagrams below whether interspersion between Cowardin vegetation (described in H1.1), or the classes and unvegetated areas (can include open water or mudflats) is high, medium, low, or none.</p> <div style="display: flex; justify-content: space-around;"> <div style="text-align: center;">  <p>None = 0 points</p> </div> <div style="text-align: center;">  <p>Low = 1 point</p> </div> <div style="text-align: center;">  <p>Moderate = 2 points</p> </div> <div style="text-align: center;">  </div> </div> <div style="display: flex; justify-content: space-around; margin-top: 10px;"> <div style="text-align: center;">  </div> <div style="text-align: center;">  <p>High = 3 points</p> </div> <div style="text-align: center;">  <p>[riparian braided channels]</p> </div> </div> <p style="text-align: right;"> <b>Note:</b> If you have 4 or more classes or 3 vegetation classes and open water, the rating is always “high”.   <b>Use map of Cowardin classes.</b> </p>	<p><b>Figure</b> ____</p> <p style="text-align: right;">1</p>
H 1.5	<p><u>Special Habitat Features</u> (see p. 77):                      Check the habitat features that are present in the wetland. The number of checks is the number of points you put into the next column.</p> <p><input type="checkbox"/> Large, downed, woody debris within the wetland (&gt; 4 in. diameter and 6 ft. long)  <input checked="" type="checkbox"/> Standing snags (diameter at the bottom &gt; 4 inches) in the wetland  <input type="checkbox"/> Undercut banks are present for at least 6.6 ft. (2m) and/or overhanging vegetation extends at least 3.3 ft. (1m) over a stream (or ditch) in, or contiguous with the unit, for at least 33 ft. (10m)  <input type="checkbox"/> Stable steep banks of fine material that might be used by beaver or muskrat for denning (&gt; 30 degree slope) OR signs of recent beaver activity are present (cut shrubs or trees that have not yet turned grey/brown)  <input type="checkbox"/> At least 1/4 acre of thin-stemmed persistent vegetation or woody branches are present in areas that are permanently or seasonally inundated (structures for egg-laying by amphibians)  <input type="checkbox"/> Invasive plants cover less than 25% of the wetland area in each stratum of plants</p> <p><i>NOTE: The 20% stated in early printings of the manual on page 78 is an error.</i></p>	<p style="text-align: right;">1</p>
<p><b>H 1 TOTAL Score</b> – potential for providing habitat</p>		<p style="text-align: right;">6</p>

Exhibit 16  
SSDP2016-00415  
007159

H 2	Does the wetland have the <u>opportunity</u> to provide habitat for many species?	(only 1 score per box)
	<p>H 2.1 <u>Buffers</u> (see P. 80):  <i>Choose the description that best represents condition of buffer of wetland unit. The highest scoring criterion that applies to the wetland is to be used in the rating. See text for definition of "undisturbed".</i></p> <p>___ 100m (330 ft) of relatively undisturbed vegetated areas, rocky areas, or open water &gt; 95% of circumference. No structures are within the undisturbed part of buffer (relatively undisturbed also means no grazing, no landscaping, no daily human use)..... <b>points = 5</b></p> <p>___ 100m (330 ft) of relatively undisturbed vegetated areas, rocky areas, or open water &gt; 50% circumference..... <b>points = 4</b></p> <p>___ 50m (170 ft) of relatively undisturbed vegetated areas, rocky areas, or open water &gt; 95% circumference..... <b>points = 4</b></p> <p>___ 100m (330 ft) of relatively undisturbed vegetated areas, rocky areas, or open water &gt; 25% circumference..... <b>points = 3</b></p> <p>___ 50m (170 ft) of relatively undisturbed vegetated areas, rocky areas, or open water for &gt; 50% circumference..... <b>points = 3</b></p> <p><b>If buffer does not meet any of the criteria above:</b></p> <p>___ No paved areas (except paved trails) or buildings within 25m (80 ft) of wetland &gt; 95% circumference. Light to moderate grazing or lawns are OK..... <b>points = 2</b></p> <p>___ No paved areas of buildings within 50m of wetland for &gt; 50% circumference. Light to moderate grazing or lawns are OK..... <b>points = 2</b></p> <p>___ Heavy grazing in buffer..... <b>points = 1</b></p> <p>___ Vegetated buffers are &lt; 2m wide (6.6 ft) for more than 95% circumference (e.g. tilled fields, paving, basalt bedrock extend to edge of wetland)..... <b>points = 0</b></p> <p><u>X</u> Buffer does not meet any of the criteria above..... <b>points = 1</b></p> <p style="text-align: right;"><b>Aerial photo showing buffers</b></p>	<p><b>Figure</b> ___</p> <p style="text-align: center;">1</p>
	<p>H 2.2 <u>Corridors and Connections</u> (see p. 81)</p> <p>H 2.2.1 Is the wetland part of a relatively undisturbed and unbroken vegetated corridor (either riparian or upland) that is at least 150 ft. wide, has at least a 30% cover of shrubs, forest or native undisturbed prairie, that connects to estuaries, other wetlands or undisturbed uplands that are at least 250 acres in size? (<i>Dams in riparian corridors, heavily used gravel roads, paved roads, are considered breaks in the corridor.</i>)</p> <p style="text-align: center;">YES = <b>4 points</b> (go to H 2.3) <span style="float: right;">NO = go to H 2.2.2</span></p> <p>H 2.2.2 Is the wetland part of a relatively undisturbed and unbroken vegetated corridor (either riparian or upland) that is at least 50 ft. wide, has at least 30% cover of shrubs or forest, and connects to estuaries, other wetlands or undisturbed uplands that are at least 25 acres in size? <b>OR a Lake-fringe</b> wetland, if it does not have an undisturbed corridor as in the question above?</p> <p style="text-align: center;">YES = <b>2 points</b> (go to H 2.3) <span style="float: right;">NO = go to H 2.2.3</span></p> <p>H 2.2.3 Is the wetland:</p> <ul style="list-style-type: none"> <li>• Within 5 mi (8km) of a brackish or salt water estuary OR</li> <li>• Within 3 miles of a large field or pasture (&gt; 40 acres) OR <span style="float: right;">YES = 1 point</span></li> <li>• <b>Within 1 mile of a lake greater than 20 acres?</b> <span style="float: right;">NO = 0 points</span></li> </ul>	<p style="text-align: center;">1</p>

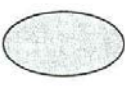
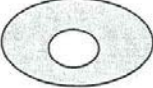
Comments:

	<p>H 2.3 <u>Near or adjacent to other priority habitats listed by WDFW</u> (see p. 82): (see new and complete descriptions of WDFW priority habitats, and the counties in which they can be found, in the PHS report <a href="http://wdfw.wa.gov/hab/phslist.htm">http://wdfw.wa.gov/hab/phslist.htm</a> )</p> <p>Which of the following priority habitats are within 330 ft. (100m) of the wetland unit?  <i>NOTE: the connections do not have to be relatively undisturbed.</i></p> <p><input type="checkbox"/> <b>Aspen Stands:</b> Pure or mixed stands of aspen greater than 0.4 ha (1 acre).</p> <p><input type="checkbox"/> <b>Biodiversity Areas and Corridors:</b> Areas of habitat that are relatively important to various species of native fish and wildlife (full descriptions in WDFW PHS report p. 152).</p> <p><input type="checkbox"/> <b>Herbaceous Balds:</b> Variable size patches of grass and forbs on shallow soils over bedrock.</p> <p><input type="checkbox"/> <b>Old-growth/Mature forests:</b> (Old-growth west of Cascade crest) Stands of at least 2 tree species, forming a multi-layered canopy with occasional small openings; with at least 20 trees/ha (8 trees/acre) &gt; 81 cm (32 in) dbh or &gt; 200 years of age. (Mature forests) Stands with average diameters exceeding 53 cm (21 in) dbh; crown cover may be less than 100%; decay, decadence, numbers of snags, and quantity of large downed material is generally less than that found in old-growth; 80 - 200 years old west of the Cascade crest.</p> <p><input type="checkbox"/> <b>Oregon white Oak:</b> Woodlands Stands of pure oak or oak/conifer associations where canopy coverage of the oak component is important (full descriptions in WDFW PHS report p. 158).</p> <p><input checked="" type="checkbox"/> <b>Riparian:</b> The area adjacent to aquatic systems with flowing water that contains elements of both aquatic and terrestrial ecosystems which mutually influence each other.</p> <p><input type="checkbox"/> <b>Westside Prairies:</b> Herbaceous, non-forested plant communities that can either take the form of a dry prairie or a wet prairie (full descriptions in WDFW PHS report p. 161).</p> <p><input checked="" type="checkbox"/> <b>Instream:</b> The combination of physical, biological, and chemical processes and conditions that interact to provide functional life history requirements for instream fish and wildlife resources.</p> <p><input type="checkbox"/> <b>Nearshore:</b> Relatively undisturbed nearshore habitats. These include Coastal Nearshore, Open Coast Nearshore, and Puget Sound Nearshore. (full descriptions of habitats and the definition of relatively undisturbed are in WDFW report: pp. 167-169 and glossary in Appendix A).</p> <p><input type="checkbox"/> <b>Caves:</b> A naturally occurring cavity, recess, void, or system of interconnected passages under the earth in soils, rock, ice, or other geological formations and is large enough to contain a human.</p> <p><input type="checkbox"/> <b>Cliffs:</b> Greater than 7.6 m (25 ft) high and occurring below 5000 ft.</p> <p><input type="checkbox"/> <b>Talus:</b> Homogenous areas of rock rubble ranging in average size 0.15 - 2.0 m (0.5 - 6.5 ft), composed of basalt, andesite, and/or sedimentary rock, including riprap slides and mine tailings. May be associated with cliffs.</p> <p><input type="checkbox"/> <b>Snags and Logs:</b> Trees are considered snags if they are dead or dying and exhibit sufficient decay characteristics to enable cavity excavation/use by wildlife. Priority snags have a diameter at breast height of &gt; 51 cm (20 in) in western Washington and are &gt; 2 m (6.5 ft) in height. Priority logs are &gt; 30 cm (12 in) in diameter at the largest end, and &gt; 6 m (20 ft) long.</p> <p>If wetland has <b>3 or more</b> priority habitats = <b>4 points</b>  <b>If wetland has 2</b> priority habitats = <b>3 points</b>                  If wetland has <b>1</b> priority habitat = <b>1 point</b>                      No habitats = 0 points</p> <p>Note: All vegetated wetlands are by definition a priority habitat but are not included in this list. Nearby wetlands are addressed in question H 2.4)</p>	3
	<p>H 2.4 <u>Wetland Landscape:</u> Choose the <b>one</b> description of the landscape around the wetland that best fits (see p. 84)</p> <ul style="list-style-type: none"> <li>• There are at least 3 other wetlands within 1/2 mile, and the connections between them are relatively undisturbed (light grazing between wetlands OK, as is lake shore with some boating, but connections should NOT be bisected by paved roads, fill, fields, or other development.....points = 5</li> <li>• The wetland is Lake-fringe on a lake with little disturbance and there are 3 other lake-fringe wetlands within 1/2 mile .....points = 5</li> <li>• <b>There are at least 3 other wetlands within 1/2 mile, BUT the connections between them are disturbed.....points = 3</b></li> <li>• The wetland fringe on a lake <b>with</b> disturbance and there are 3 other lake-fringe wetlands within 1/2 mile .....points = 3</li> <li>• There is at least 1 wetland within 1/2 mile .....points = 2</li> <li>• There are no wetlands within 1/2 mile.....points = 0</li> </ul>	3
<p><b>H 2 TOTAL Score</b> – opportunity for providing habitat      <i>Add the scores from H2.1, H2.2, H2.3, H2.4</i></p>		8
<p><i>TOTAL for H 1 from page 8</i></p>		6
◆	<p><b>Total Score for Habitat Functions</b>                      Add the points for H 1 and H 2; then <b>record the result on p. 1</b></p>	14

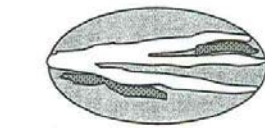
Comments:

### CATEGORIZATION BASED ON SPECIAL CHARACTERISTICS

*Please determine if the wetland meets the attributes described below  
and circle the appropriate answers and Category.*

<b>Wetland Type</b> – Check off any criteria that apply to the wetland. Circle the Category when the appropriate criteria are met.		
<b>SC1</b>	<p><b>Estuarine wetlands?</b> (see p.86)</p> <p>Does the wetland unit meet the following criteria for Estuarine wetlands?</p> <p><input type="checkbox"/> The dominant water regime is tidal,</p> <p><input type="checkbox"/> Vegetated, and</p> <p><input type="checkbox"/> With a salinity greater than 0.5 ppt.</p> <p style="text-align: center;">YES = Go to SC 1.1                      NO <u>  X  </u></p>	
SC 1.1	<p>Is the wetland unit within a National Wildlife Refuge, National Park, National Estuary Reserve, Natural Area Preserve, State Park or Educational, Environmental, or Scientific Reserve designated under WAC 332-30-151?      YES = Category I                      NO = go to SC 1.2</p>	<b>Cat. I</b>
SC 1.2	<p>Is the wetland at least 1 acre in size and meets at least two of the following conditions?</p> <p style="text-align: center;">YES = Category I                      NO = Category II</p> <p><input type="checkbox"/> The wetland is relatively undisturbed (has no diking, ditching, filling, cultivation, grazing, and has less than 10% cover of non-native plant species. If the non-native <i>Spartina</i> spp., are only species that cover more than 10% of the wetland, then the wetland should be given a dual rating (I/II). The area of <i>Spartina</i> would be rated a Category II while the relatively undisturbed upper marsh with native species would be a Category I. Do not, however, exclude the area of <i>Spartina</i> in determining the size threshold of 1 acre.</p> <p><input type="checkbox"/> At least 3/4 of the landward edge of the wetland has a 100 ft. buffer of shrub, forest, or un-grazed or un-mowed grassland</p> <p><input type="checkbox"/> The wetland has at least 2 of the following features: tidal channels, depressions with open water, or contiguous freshwater wetlands.</p>	<b>Cat. I</b>  <b>Cat. II</b>  <b>Dual Rating I/II</b>
<b>SC2</b>	<p><b>Natural Heritage Wetlands</b> (see p. 87)</p> <p>Natural Heritage wetlands have been identified by the Washington Natural Heritage Program/DNR as either high quality undisturbed wetlands or wetlands that support state Threatened, Endangered, or Sensitive plant species.</p> <p>SC 2.1 Is the wetland being rated in a Section/Township/Range that contains a natural heritage wetland? (<i>This question is used to screen out most sites before you need to contact WNHP/DNR.</i>)</p> <p style="text-align: center;">S/T/R information from Appendix D _____ or accessed from WNHP/DNR web site _____</p> <p style="text-align: center;">YES _____ Contact WNHP/DNR (see p. 79) and go to SC 2.2      NO <u>  X  </u></p> <p>SC 2.2 Has DNR identified the wetland as a high quality undisturbed wetland or as a site with state threatened or endangered plant species?</p> <p style="text-align: center;">YES = Category 1                      NO _____ not a Heritage Wetland</p>	<b>Cat I</b>
<b>SC3</b>	<p><b>Bogs</b> (see p. 87)</p> <p>Does the wetland (<b>or any part of the unit</b>) meet both the criteria for soils and vegetation in bogs? Use the key below to identify if the wetland is a bog. <i>If you answer yes you will still need to rate the wetland based on its function.</i></p> <ol style="list-style-type: none"> <li>1. Does the unit have organic soil horizons (i.e. layers of organic soil), either peats or mucks, that compose 16 inches or more of the first 32 inches of soil profile? (See Appendix B for a field key to identify organic soils)?      YES = go to question 3      <b>NO = go to question 2</b></li> <li>2. Does the wetland have organic soils, either peats or mucks that are less than 16 inches deep over bedrock, or an impermeable hardpan such as clay or volcanic ash, or that are floating on a lake or pond?      YES = go to question 3      <b>NO = is not a bog for purpose of rating</b></li> <li>3. Does the unit have more than 70% cover of mosses at ground level, AND other plants, if present, consist of the “bog” species listed in Table 3 as a significant component of the vegetation (more than 30% of the total shrub and herbaceous cover consists of species in Table 3)?</li> </ol> <p style="text-align: center;">YES = Is a bog for purpose of rating      NO = go to question 4</p> <p>NOTE: If you are uncertain about the extent of mosses in the understory you may substitute that criterion by measuring the pH of the water that seeps into a hole dug at least 16” deep. If the pH is less than 5.0 and the “bog” plant species in Table 3 are present, the wetland is a bog.</p> <ol style="list-style-type: none"> <li>4. Is the unit forested (&gt; 30% cover) with sitka spruce, subalpine fir, western red cedar, western hemlock, lodgepole pine, quaking aspen, Englemann’s spruce, or western white pine. WITH any of the species (or combination of species) on the bog species plant list in Table 3 as a significant component of the ground cover (&gt; 30% coverage of the total shrub/herbaceous cover)?</li> </ol> <p style="text-align: center;">YES = Category I                      NO = Is not a bog for purpose of rating</p>	<b>Cat. I</b>

**Exhibit 16**  
**SSDP2016-00415**  
**001162**

SC4	<p><b>Forested Wetlands</b> (see p. 90)</p> <p>Does the wetland have at least 1 acre of forest that meet one of these criteria for the Department of Fish and Wildlife's forests as priority habitats? <i>If you answer yes you will still need to rate the wetland based on its function.</i></p> <p>___ <b>Old-growth forests:</b> (west of Cascade Crest) Stands of at least two three species forming a multi-layered canopy with occasional small openings; with at least 8 trees/acre (20 trees/hectare) that are at least 200 years of age OR have a diameter at breast height (dbh) of 32 inches (81 cm or more).</p> <p>NOTE: The criterion for dbh is based on measurements for upland forests. Two-hundred year old trees in wetlands will often have a smaller dbh because their growth rates are often slower. The DFW criterion is and "OR" so old-growth forests do not necessarily have to have trees of this diameter.</p> <p>___ <b>Mature forests:</b> (west of the Cascade Crest) Stands where the largest trees are 80 – 200 years old OR have an average diameters (dbh) exceeding 21 inches (53 cm); crown cover may be less than 100%; decay, decadence, numbers of snags, and quantity of large downed material is generally less than that found in old-growth.</p> <p>YES = Category I                      NO = <u>X</u> not a forested wetland with special characteristics</p>	Cat. I
SC5	<p><b>Wetlands in Coastal Lagoons</b> (see p. 91)</p> <p>Does the wetland meet all of the following criteria of a wetland in a coastal lagoon?</p> <p>___ The wetland lies in a depression adjacent to marine waters that is wholly or partially separated from marine waters by sandbanks, gravel banks, shingle, or, less frequently, rocks.</p> <p>___ The lagoon in which the wetland is located contains surface water that is saline or brackish (&gt; 0.5 ppt) during most of the year in at least a portion of the lagoon (<i>needs to be measured near the bottom.</i>)</p> <p>YES = Go to SC 5.1                      NO <u>X</u> not a wetland in a coastal lagoon</p> <p>SC 5.1 Does the wetland meet all of the following three conditions?</p> <p>___ The wetland is relatively undisturbed (has no diking, ditching, filling, cultivation, grazing) and has less than 20% cover of invasive plant species (see list of invasive species on p. 74).</p> <p>___ At least 3/4 of the landward edge of the wetland has a 100 ft. buffer of shrub, forest, or un-grazed or un-mowed grassland.</p> <p>___ The wetland is larger than 1/10 acre (4350 square ft.)</p> <p>YES = Category I                      NO = Category II</p>	Cat. I Cat. II
SC6	<p><b>Interdunal Wetlands</b> (see p. 93)</p> <p>Is the wetland west of the 1889 line (also called the Western Boundary of Upland Ownership or WBUO)?</p> <p>YES = Go to SC 6.1                      NO <u>X</u> not an interdunal wetland for rating</p> <p><i>If you answer yes you will still need to rate the wetland based on its functions.</i></p> <p>In practical terms that means the following geographic areas:</p> <ul style="list-style-type: none"> <li>• Long Beach Peninsula -- lands west of SR 103</li> <li>• Grayland-Westport -- lands west of SR 105</li> <li>• Ocean Shores-Copalis – lands west of SR 115 and SR 109</li> </ul> <p>SC 6.1 Is the wetland one acre or larger, or is it in a mosaic of wetlands that is one acre or larger?</p> <p>YES = Category II                      NO = go to SC 6.2</p> <p>SC 6.2 Is the wetland between 0.1 and 1 acre, or is it in a mosaic of wetlands that is between 0.1 and 1 acre?</p> <p>YES = Category III</p>	Cat. II Cat. III
◆	<p><b>Category of wetland based on Special Characteristics</b></p> <p>Choose the "highest" rating if wetland falls into several categories, and record on p. 1.</p> <p>If you answered NO for all types enter "Not Applicable" on p. 1</p>	NA

Comments:



**WETLAND RATING FORM – WESTERN WASHINGTON**  
Version 2 – Updated July 2006 to increase accuracy and reproducibility among users  
Updated Oct. 2008 with the new WDFW definitions for priority habitats

Name of wetland (if known): 25F Date of site visit: 09-27-13

Rated by: Colin Worsley / Matt Maynard Trained by Ecology? Yes X No      Date of training: 11-2005 / 04-2006

SEC: 32 TOWNSHIP: 25N RANGE: 06E Is S/T/R in Appendix D? Yes      No X

Map of wetland unit: Figure      Estimated size 0.33 acre

**SUMMARY OF RATING**

Category based on FUNCTIONS provided by wetland: I      II      III      IV X

Category I =	Score > 70
Category II =	Score 51 - 69
Category III =	Score 30 – 50
Category IV =	Score < 30

Score for Water Quality Functions	12
Score for Hydrologic Functions	6
Score for Habitat Functions	12
<b>TOTAL Score for Functions</b>	<b>30</b>

Category based on SPECIAL CHARACTERISTICS of Wetland I      II      Does not apply X

**Final Category** (choose the “highest” category from above”) **III**

**Summary of basic information about the wetland unit.**

Wetland Unit has Special Characteristics		Wetland HGM Class used for Rating	
<b>Estuarine</b>		<b>Depressional</b>	<b>X</b>
<b>Natural Heritage Wetland</b>		<b>Riverine</b>	
<b>Bog</b>		<b>Lake-fringe</b>	
<b>Mature Forest</b>		<b>Slope</b>	
<b>Old Growth Forest</b>		<b>Flats</b>	
<b>Coastal Lagoon</b>		<b>Freshwater Tidal</b>	
<b>Interdunal</b>			
None of the above	X	Check if unit has multiple HGM classes present	<span style="border: 1px solid black; padding: 2px;">    </span>

**Does the wetland being rated meet any of the criteria below?** If you answer YES to any of the questions below you will need to protect the wetland according to the regulations regarding the special characteristics found in the wetland.

Check List for Wetlands that Need Additional Protection (in addition to the protection recommended for its category)	YES	NO
SP1. <i>Has the wetland unit been documented as a habitat for any Federally listed Threatened or Endangered <b>animal or plant</b> species (T/E species)?</i> For the purposes of this rating system, “documented” means the wetland is on the appropriate state or federal database.		X
SP2. <i>Has the wetland unit been documented as habitat for any State listed Threatened or Endangered <b>animal</b> species?</i> For the purposes of this rating system, “documented” means the wetland is on the appropriate state database. Note: Wetlands with State listed plant species are categorized as Category 1 Natural Heritage Wetlands (see p. 19 of data form).		X
SP3. <i>Does the wetland unit contain individuals of Priority species listed by the WDFW for the state?</i>		X
SP4. <i>Does the wetland unit have a local significance in addition to its functions?</i> For example, the wetland has been identified in the Shoreline Master Program, the Critical Areas Ordinance, or in a local management plan as having special significance.		X

To complete the next part of the data sheet you will need to determine the Hydrogeomorphic Class of the wetland being rated.

Exhibit 16  
SSDP2016-00415  
001104

### Classification of Vegetated Wetlands for Western Washington

If the hydrologic criteria listed in each question do not apply to the entire unit being rated, you probably have a unit with multiple HGM classes. In this case, identify which hydrologic criteria in questions 1-7 apply, and go to Question 8.

1. Are the water levels in the entire unit usually controlled by tides (i.e. except during floods)?  
NO – go to 2                      **YES – the wetland class is Tidal Fringe**  
 If yes, is the salinity of the water during periods of annual low flow below 0.5 ppt (parts per thousand)?  
**YES – Freshwater Tidal Fringe**                      **NO – Saltwater Tidal Fringe (Estuarine)**  
*If your wetland can be classified as a Freshwater Tidal Fringe use the forms for Riverine wetlands. If it is a Saltwater Tidal Fringe it is rated as an Estuarine wetland. Wetlands that were call estuarine in the first and second editions of the rating system are called Salt Water Tidal Fringe in the Hydrogeomorphic Classification. Estuarine wetlands were categorized separately in the earlier editions, and this separation is being kept in this revision. To maintain consistency between editions, the term “Estuarine” wetland is kept. Please note, however, that the characteristics that define Category I and II estuarine wetlands have changed (see p. \_\_\_\_).*

---

2. The entire wetland unit is flat and precipitation is only source (>90%) of water to it. Groundwater and surface water runoff are NOT sources of water to the unit.  
NO – go to 3                      **YES – The wetland class is Flats**  
 If your wetland can be classified as a “Flats” wetland, use the form for **Depressional** wetlands.

---

3. Does the entire wetland meet both of the following criteria?  
 \_\_\_\_\_ The vegetated part of the wetland is on the shores of a body of permanent open water (without any vegetation on the surface) where at least 20 acres (8ha) in size;  
 \_\_\_\_\_ At least 30% of the open water area is deeper than 6.6 (2 m)?  
NO – go to 4                      **YES – The wetland class is Lake-fringe (Lacustrine Fringe)**

---

4. Does the entire wetland meet all of the following criteria?  
 \_\_\_\_\_ The wetland is on a slope (*slope can be very gradual*).  
 \_\_\_\_\_ The water flows through the wetland in one direction (unidirectional) and usually comes from seeps. It may flow subsurface, as sheetflow, or in a swale without distinct banks.  
 \_\_\_\_\_ The water leaves the wetland **without being impounded**?  
 NOTE: *Surface water does not pond in these types of wetlands except occasionally in very small and shallow depressions or behind hummocks (depressions are usually <3 ft diameter and less than 1 foot deep).*  
NO – go to 5                      **YES – The wetland class is Slope**

---

5. Does the entire wetland meet all of the following criteria?  
 \_\_\_\_\_ The unit is in a valley or stream channel where it gets inundated by overbank flooding from that stream or river.  
 \_\_\_\_\_ The overbank flooding occurs at least once every two years.  
 NOTE: *The riverine unit can contain depressions that are filled with water when the river is not flooding..*  
NO – go to 6                      **YES – The wetland class is Riverine**

---

6. Is the entire wetland unit in a topographic depression in which water ponds, or is saturated to the surface, at some time of the year. This means that any outlet, if present is higher than the interior of the wetland.  
NO – go to 7                      **YES – The wetland class is Depressional**

---

7. Is the entire wetland located in a very flat area with no obvious depression and no overbank flooding. The unit does not pond surface water more than a few inches. The unit seems to be maintained by high groundwater in the area. The wetland may be ditched, but has no obvious natural outlet.  
No – go to 8                      **YES – The wetland class is Depressional**

---

8. Your wetland unit seems to be difficult to classify and probably contains several different HGM classes. For example, seeps at the base of a slope may grade into a riverine floodplain, or a small stream within a depressional wetland has a zone of flooding along its sides. **GO BACK AND IDENTIFY WHICH OF THE HYDROLOGIC REGIMES DESCRIBED IN QUESTIONS 1-7 APPLY TO DIFFERENT AREAS IN THE UNIT** (make a rough sketch to help you decide). Use the following table to identify the appropriate class to use for the rating system if you have several HGM classes present within your wetland. NOTE: Use this table only if the class that is recommended in the second column represents 10% or more of the total area of the wetland unit being rated. If the area of the class listed in column 2 is less than 10% of the unit, classify the wetland using the class that represents more than 90% of the total area.

HGM Classes within the wetland unit being rated	HGM Class to Use in Rating
Slope + Riverine	Riverine
Slope + Depressional	Depressional
Slope + Lake-fringe	Lake-fringe
Depressional + Riverine along stream within boundary	Depressional
Depressional + Lake-fringe	Depressional
Salt Water Tidal Fringe and any other class of freshwater wetland	Treat as ESTUARINE under wetlands with special characteristics

**Exhibit 16**  
**SSDP2016-00415**  
**001165**

If you are unable still to determine which of the above criteria apply to your wetland, or you have more than 2 HGM classes within a wetland boundary, classify the wetland as **Depressional** for the rating.

<b>D Depressional and Flat Wetlands</b>		<b>Points</b>
WATER QUALITY FUNCTIONS – Indicators that wetland functions to improve water quality.		(only 1 score per box) <i>(see p.38)</i>
<b>D 1</b>	<b>Does the wetland have the <u>potential</u> to improve water quality?</b>	
D 1.1	Characteristics of surface water flows out of the wetland: • Unit is a depression with no surface water leaving it (no outlet)..... points = 3 • Unit has an intermittently flowing, OR highly constricted, permanently flowing outlet ..... points = 2 • <b>Unit has an unconstricted, or slightly constricted, surface outlet (<i>permanently flowing</i>) ..... points = 1</b> • Unit is a “flat” depression (Q.7 on key), or in the Flats class, with permanent surface outflow <b>and no obvious natural outlet</b> and/or outlet is a man-made ditch..... points = 1 <i>(If ditch is not permanently flowing treat unit as “intermittently flowing”)</i> <b>Provide photo or drawing</b>	Figure ____  1
D 1.2	The soil 2 inches below the surface (or duff layer) is clay or organic <i>(use NRCS definitions)</i> YES points = 4 <b>NO points = 0</b>	0
D 1.3	Characteristics of persistent vegetation (emergent, shrub, and/or forest Cowardin class): • <b>Wetland has persistent, ungrazed vegetation &gt;= 95% of area..... points = 5</b> • Wetland has persistent, ungrazed vegetation > = 1/2 of area..... points = 3 • Wetland has persistent, ungrazed vegetation > = 1/10 of area..... points = 1 • Wetland has persistent, ungrazed vegetation < 1/10 of area..... points = 0 <b>Map of Cowardin vegetation classes</b>	Figure ____  5
D 1.4	Characteristics of seasonal ponding or inundation: <i>This is the area of the wetland that is ponded for at least 2 months, but dries out sometime during the year. Do not count the area that is permanently ponded. Estimate area as the average condition 5 out of 10 years.</i> • Area seasonally ponded is > 1/2 total area of wetland ..... points = 4 • Area seasonally ponded is > 1/4 total area of wetland ..... points = 2 • <b>Area seasonally ponded is &lt; 1/4 total area of wetland ..... points = 0</b> <b>Map of Hydroperiods</b>	Figure ____  0
<b>Total for D 1</b>		<i>Add the points in the boxes above</i> <b>6</b>
<b>D 2</b>	<b>Does the wetland have the <u>opportunity</u> to improve water quality?</b> Answer YES if you know or believe there are pollutants in groundwater or surface water coming into the wetland that would otherwise reduce water quality in streams, lakes or groundwater downgradient from the wetland? <i>Note which of the following conditions provide the sources of pollutants. A unit may have pollutants coming from several sources, but any single source would qualify as opportunity.</i> <input type="checkbox"/> Grazing in the wetland or within 150 ft <input type="checkbox"/> Untreated stormwater discharges to wetland <input type="checkbox"/> Tilled fields or orchards within 150 ft. of wetland <input type="checkbox"/> A stream or culvert discharges into wetland that drains developed areas, residential areas, farmed fields, roads, or clear-cut logging <input checked="" type="checkbox"/> Residential, urban areas, golf courses are within 150 ft. of wetland <input type="checkbox"/> Wetland is fed by groundwater high in phosphorus or nitrogen <input type="checkbox"/> Other _____ <b>YES multiplier is 2</b> NO multiplier is 1	<i>(see p. 44)</i>        Multiplier  <u>X2</u>
<b>◆</b>	<b>TOTAL – Water Quality Functions</b> Multiply the score from D1 by D2; then <i>add score to table on p. 1</i>	12
HYDROLOGIC FUNCTIONS – Indicators that wetland unit functions to reduce flooding and stream degradation.		
<b>D 3</b>	<b>Does the wetland have the <u>potential</u> to reduce flooding and erosion?</b>	<i>(see p.46)</i>
D 3.1	Characteristics of surface water flows out of the wetland unit • Unit is a depression with no surface water leaving it (no outlet)..... points = 4 • Unit has an intermittently flowing, OR highly constricted permanently flowing outlet ..... points = 2 • Unit is a “flat” depression (Q.7 on key) or in the Flats class, with permanent surface outflow <b>and no obvious natural outlet</b> and/or outlet is a man-made ditch..... points = 1 <i>(If ditch is not permanently flowing treat unit as “intermittently flowing”)</i> • <b>Unit has an unconstricted, or slightly constricted, surface outlet (<i>permanently flowing</i>) ..... points = 0</b>	0
D 3.2	Depth of storage during wet periods. <i>Estimate the height of ponding above the bottom of the outlet. For units with no outlet measure from the surface of permanent water or deepest part (if dry).</i> • Marks of ponding are 3 ft. or more above the surface or bottom of the outlet ..... points = 7 • The wetland is a “headwater” wetland..... points = 5 • Marks of ponding between 2 ft. to < 3 ft. from surface or bottom of outlet ..... points = 5 • Marks are at least 0.5 ft. to < 2 ft. from surface or bottom of outlet..... points = 3 • Wetland is flat (yes to Q.2 or Q.7)but has small depressions on the surface that trap water points = 1 • <b>Marks of ponding less than 0.5 ft ..... points = 0</b>	0
D 3.3	Contribution of wetland unit to storage in the watershed: <i>Estimate the ratio of the area of upstream basin contributing surface water to the wetland to the area of the wetland unit itself.</i> • The area of the basin is less than 10 times the area of unit..... points = 5 • <b>The area of the basin is 10 to 100 times the area of the unit ..... points = 3</b> • The area of the basin is more than 100 times the area of the unit..... points = 0 • Entire unit is in the FLATS class ..... points = 5	3
<b>Total for D 3</b>		<i>Add the points in the boxes above</i> <b>3</b>

<b>D 4</b>	<p><b>Does the wetland have the <u>opportunity</u> to reduce flooding and erosion?</b></p> <p>Answer YES if the unit is in a location in the watershed where the flood storage, or reduction in water velocity, it provides helps protect downstream property and aquatic resources from flooding or excessive and/or erosive flows. Answer NO if the water coming into the wetland is controlled by a structure such as flood gate, tide gate, flap valve, reservoir etc. OR you estimate that more than 90% of the water in the wetland is from groundwater in areas where damaging groundwater flooding does not occur. <i>Note which of the following indicators of opportunity apply.</i></p> <p><input type="checkbox"/> Wetland is in a headwater of a river or stream that has flooding problems.</p> <p><input type="checkbox"/> Wetland drains to a river or stream that has flooding problems</p> <p><input type="checkbox"/> Wetland has no outlet and impounds surface runoff water that might otherwise flow into a river or stream that has flooding problems</p> <p><input type="checkbox"/> Other _____</p> <p><b>YES multiplier is 2</b>                      NO multiplier is 1</p>	<p>(see p. 49)</p> <p>Multiplier</p> <p><u>X2</u></p>
◆	<p><b>TOTAL – Hydrologic Functions</b>                      Multiply the score from D3 by D4; then <i>add score to table on p. 1</i></p>	<p>6</p>

Comments:







<p><i>These questions apply to wetlands of all HGM classes.</i></p> <p>HABITAT FUNCTIONS – Indicators that wetland functions to provide important habitat.</p>		<p><b>Points</b> (only 1 score per box)</p>
<b>H 1</b>	<b>Does the wetland have the <u>potential</u> to provide habitat for many species?</b>	
H 1.1	<p><u>Vegetation structure</u> (see P. 72): Check the types of vegetation classes present (as defined by Cowardin) – Size threshold for each class is 1/4 acre or more than 10% of the area if unit is smaller than 2.5 acres.</p> <p><input type="checkbox"/> Aquatic Bed <input type="checkbox"/> Emergent plants <input type="checkbox"/> Scrub/shrub (areas where shrubs have &gt; 30% cover) <input checked="" type="checkbox"/> Forested (areas where trees have &gt; 30% cover) If the unit has a forested class check if: <input type="checkbox"/> The forested class has 3 out of 5 strata (canopy, sub-canopy, shrubs, herbaceous, moss/ground-cover) that each cover 20% within the forested polygon. Add the number of vegetation types that qualify. If you have:</p> <p>4 structures or more ..... points = 4 3 structures ..... points = 2 1 structure ..... points = 0</p> <p><b>Map of Cowardin vegetation classes</b></p>	<p><b>Figure</b> ____</p> <p>0</p>
H 1.2	<p><u>Hydroperiods</u> (see p.73): Check the types of water regimes (hydroperiods) present within the wetland. The water regime has to cover more than 10% of the wetland or 1/4 acre to count (see text for descriptions of hydroperiods).</p> <p><input type="checkbox"/> Permanently flooded or inundated <input checked="" type="checkbox"/> Seasonally flooded or inundated <input type="checkbox"/> Occasionally flooded or inundated <input checked="" type="checkbox"/> Saturated only <input checked="" type="checkbox"/> Permanently flowing stream or river in, or adjacent to, the wetland <input type="checkbox"/> Seasonally flowing stream in, or adjacent to, the wetland <input type="checkbox"/> Lake-fringe wetland ..... = 2 points <input type="checkbox"/> Freshwater tidal wetland ..... = 2 points</p> <p><b>Map of hydroperiods</b></p>	<p><b>Figure</b> ____</p> <p>2</p>
H 1.3	<p><u>Richness of Plant Species</u> (see p. 75): Count the number of plant species in the wetland that cover at least 10 ft<sup>2</sup> (different patches of the same species can be combined to meet the size threshold) You do not have to name the species. Do not include Eurasian Milfoil, reed canarygrass, purple loosestrife, Canadian Thistle. If you counted: &gt; 19 species ..... points = 2 5 – 19 species ..... points = 1 &lt; 5 species ..... points = 0</p> <p>List species below if you want to:</p> <p>_____ _____ _____</p>	<p>1</p>
H 1.4	<p><u>Interspersion of Habitats</u> (see p. 76): Decided from the diagrams below whether interspersion between Cowardin vegetation (described in H1.1), or the classes and unvegetated areas (can include open water or mudflats) is high, medium, low, or none.</p> <div style="display: flex; justify-content: space-around;"> <div style="text-align: center;">  None = 0 points         </div> <div style="text-align: center;">  Low = 1 point         </div> <div style="text-align: center;">  Moderate = 2 points         </div> <div style="text-align: center;">   </div> </div> <div style="display: flex; justify-content: space-around; margin-top: 10px;"> <div style="text-align: center;">   </div> <div style="text-align: center;">  High = 3 points         </div> <div style="text-align: center;">  [riparian braided channels]         </div> </div> <p>Note: If you have 4 or more classes or 3 vegetation classes and open water, the rating is always “high”. Use map of Cowardin classes.</p>	<p><b>Figure</b> ____</p> <p>0</p>
H 1.5	<p><u>Special Habitat Features</u> (see p. 77): Check the habitat features that are present in the wetland. The number of checks is the number of points you put into the next column.</p> <p><input checked="" type="checkbox"/> Large, downed, woody debris within the wetland (&gt; 4 in. diameter and 6 ft. long) <input type="checkbox"/> Standing snags (diameter at the bottom &gt; 4 inches) in the wetland <input type="checkbox"/> Undercut banks are present for at least 6.6 ft. (2m) and/or overhanging vegetation extends at least 3.3 ft. (1m) over a stream (or ditch) in, or contiguous with the unit, for at least 33 ft. (10m) <input type="checkbox"/> Stable steep banks of fine material that might be used by beaver or muskrat for denning (&gt; 30 degree slope) OR signs of recent beaver activity are present (cut shrubs or trees that have not yet turned grey/brown) <input type="checkbox"/> At least 1/4 acre of thin-stemmed persistent vegetation or woody branches are present in areas that are permanently or seasonally inundated (structures for egg-laying by amphibians) <input type="checkbox"/> Invasive plants cover less than 25% of the wetland area in each stratum of plants NOTE: The 20% stated in early printings of the manual on page 78 is an error.</p>	<p>1</p>
<b>H 1 TOTAL Score – potential for providing habitat</b>		<p>Add the points in the column</p> <p><b>4</b></p>

Exhibit 16  
SSDP2016-00415  
001168

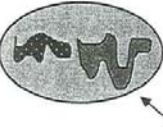

	<p>H 2.3 <u>Near or adjacent to other priority habitats listed by WDFW</u> (see p. 82): (see new and complete descriptions of WDFW priority habitats, and the counties in which they can be found, in the PHS report <a href="http://wdfw.wa.gov/hab/phslist.htm">http://wdfw.wa.gov/hab/phslist.htm</a>)</p> <p>Which of the following priority habitats are within 330 ft. (100m) of the wetland unit?  <i>NOTE: the connections do not have to be relatively undisturbed.</i></p> <p><input type="checkbox"/> <b>Aspen Stands:</b> Pure or mixed stands of aspen greater than 0.4 ha (1 acre).</p> <p><input type="checkbox"/> <b>Biodiversity Areas and Corridors:</b> Areas of habitat that are relatively important to various species of native fish and wildlife (full descriptions in WDFW PHS report p. 152).</p> <p><input type="checkbox"/> <b>Herbaceous Balds:</b> Variable size patches of grass and forbs on shallow soils over bedrock.</p> <p><input type="checkbox"/> <b>Old-growth/Mature forests:</b> (Old-growth west of Cascade crest) Stands of at least 2 tree species, forming a multi-layered canopy with occasional small openings; with at least 20 trees/ha (8 trees/acre) &gt; 81 cm (32 in) dbh or &gt; 200 years of age. (Mature forests) Stands with average diameters exceeding 53 cm (21 in) dbh; crown cover may be less than 100%; decay, decadence, numbers of snags, and quantity of large downed material is generally less than that found in old-growth; 80 - 200 years old west of the Cascade crest.</p> <p><input type="checkbox"/> <b>Oregon white Oak:</b> Woodlands Stands of pure oak or oak/conifer associations where canopy coverage of the oak component is important (full descriptions in WDFW PHS report p. 158).</p> <p><input checked="" type="checkbox"/> <b>Riparian:</b> The area adjacent to aquatic systems with flowing water that contains elements of both aquatic and terrestrial ecosystems which mutually influence each other.</p> <p><input type="checkbox"/> <b>Westside Prairies:</b> Herbaceous, non-forested plant communities that can either take the form of a dry prairie or a wet prairie (full descriptions in WDFW PHS report p. 161).</p> <p><input checked="" type="checkbox"/> <b>Instream:</b> The combination of physical, biological, and chemical processes and conditions that interact to provide functional life history requirements for instream fish and wildlife resources.</p> <p><input type="checkbox"/> <b>Nearshore:</b> Relatively undisturbed nearshore habitats. These include Coastal Nearshore, Open Coast Nearshore, and Puget Sound Nearshore. (full descriptions of habitats and the definition of relatively undisturbed are in WDFW report: pp. 167-169 and glossary in Appendix A).</p> <p><input type="checkbox"/> <b>Caves:</b> A naturally occurring cavity, recess, void, or system of interconnected passages under the earth in soils, rock, ice, or other geological formations and is large enough to contain a human.</p> <p><input type="checkbox"/> <b>Cliffs:</b> Greater than 7.6 m (25 ft) high and occurring below 5000 ft.</p> <p><input type="checkbox"/> <b>Talus:</b> Homogenous areas of rock rubble ranging in average size 0.15 - 2.0 m (0.5 - 6.5 ft), composed of basalt, andesite, and/or sedimentary rock, including riprap slides and mine tailings. May be associated with cliffs.</p> <p><input type="checkbox"/> <b>Snags and Logs:</b> Trees are considered snags if they are dead or dying and exhibit sufficient decay characteristics to enable cavity excavation/use by wildlife. Priority snags have a diameter at breast height of &gt; 51 cm (20 in) in western Washington and are &gt; 2 m (6.5 ft) in height. Priority logs are &gt; 30 cm (12 in) in diameter at the largest end, and &gt; 6 m (20 ft) long.</p> <p>If wetland has <b>3 or more</b> priority habitats = <b>4 points</b>  <b>If wetland has 2</b> priority habitats = <b>3 points</b>                  If wetland has <b>1</b> priority habitat = <b>1 point</b>                      No habitats = 0 points</p> <p>Note: All vegetated wetlands are by definition a priority habitat but are not included in this list. Nearby wetlands are addressed in question H 2.4)</p>	3
	<p>H 2.4 <u>Wetland Landscape:</u> Choose the <b>one</b> description of the landscape around the wetland that best fits (see p. 84)</p> <ul style="list-style-type: none"> <li>• There are at least 3 other wetlands within 1/2 mile, and the connections between them are relatively undisturbed (light grazing between wetlands OK, as is lake shore with some boating, but connections should NOT be bisected by paved roads, fill, fields, or other development.....points = 5</li> <li>• The wetland is Lake-fringe on a lake with little disturbance and there are 3 other lake-fringe wetlands within 1/2 mile .....points = 5</li> <li>• <b>There are at least 3 other wetlands within 1/2 mile, BUT the connections between them are disturbed.....points = 3</b></li> <li>• The wetland fringe on a lake <b>with</b> disturbance and there are 3 other lake-fringe wetlands within 1/2 mile .....points = 3</li> <li>• There is at least 1 wetland within 1/2 mile .....points = 2</li> <li>• There are no wetlands within 1/2 mile.....points = 0</li> </ul>	3
<p><b>H 2 TOTAL Score</b> – opportunity for providing habitat                      Add the scores from H2.1, H2.2, H2.3, H2.4</p>		8
		<p>TOTAL for H 1 from page 8</p>
<p>◆ <b>Total Score for Habitat Functions</b>                      Add the points for H 1 and H 2; then <b>record the result on p. 1</b></p>		12

Comments:

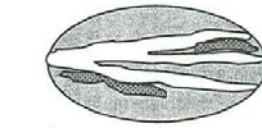
### CATEGORIZATION BASED ON SPECIAL CHARACTERISTICS

Please determine if the wetland meets the attributes described below and circle the appropriate answers and Category.

<b>Wetland Type – Check off any criteria that apply to the wetland. Circle the Category when the appropriate criteria are met.</b>		
<b>SC1</b>	<b>Estuarine wetlands?</b> (see p.86) Does the wetland unit meet the following criteria for Estuarine wetlands? <input type="checkbox"/> The dominant water regime is tidal, <input type="checkbox"/> Vegetated, and <input type="checkbox"/> With a salinity greater than 0.5 ppt. YES = Go to SC 1.1    NO <u>X</u>	
	SC 1.1 Is the wetland unit within a National Wildlife Refuge, National Park, National Estuary Reserve, Natural Area Preserve, State Park or Educational, Environmental, or Scientific Reserve designated under WAC 332-30-151?    YES = Category I    NO = go to SC 1.2	<b>Cat. I</b>
	SC 1.2 Is the wetland at least 1 acre in size and meets at least two of the following conditions? YES = Category I    NO = Category II <input type="checkbox"/> The wetland is relatively undisturbed (has no diking, ditching, filling, cultivation, grazing, and has less than 10% cover of non-native plant species. If the non-native <i>Spartina</i> spp., are only species that cover more than 10% of the wetland, then the wetland should be given a dual rating (I/II). The area of <i>Spartina</i> would be rated a Category II while the relatively undisturbed upper marsh with native species would be a Category I. Do not, however, exclude the area of <i>Spartina</i> in determining the size threshold of 1 acre. <input type="checkbox"/> At least 3/4 of the landward edge of the wetland has a 100 ft. buffer of shrub, forest, or un-grazed or un-mowed grassland <input type="checkbox"/> The wetland has at least 2 of the following features: tidal channels, depressions with open water, or contiguous freshwater wetlands.	<b>Cat. I</b> <b>Cat. II</b> <b>Dual Rating I/II</b>
<b>SC2</b>	<b>Natural Heritage Wetlands</b> (see p. 87) Natural Heritage wetlands have been identified by the Washington Natural Heritage Program/DNR as either high quality undisturbed wetlands or wetlands that support state Threatened, Endangered, or Sensitive plant species. SC 2.1 Is the wetland being rated in a Section/Township/Range that contains a natural heritage wetland? (This question is used to screen out most sites before you need to contact WNHP/DNR.) S/T/R information from Appendix D _____ or accessed from WNHP/DNR web site _____ YES _____ Contact WNHP/DNR (see p. 79) and go to SC 2.2    NO <u>X</u> SC 2.2 Has DNR identified the wetland as a high quality undisturbed wetland or as a site with state threatened or endangered plant species? YES = Category 1    NO _____ not a Heritage Wetland	<b>Cat I</b>
<b>SC3</b>	<b>Bogs</b> (see p. 87) Does the wetland ( <b>or any part of the unit</b> ) meet both the criteria for soils and vegetation in bogs? Use the key below to identify if the wetland is a bog. <i>If you answer yes you will still need to rate the wetland based on its function.</i> 1. Does the unit have organic soil horizons (i.e. layers of organic soil), either peats or mucks, that compose 16 inches or more of the first 32 inches of soil profile? (See Appendix B for a field key to identify organic soils)?    YES = go to question 3    NO = go to question 2 2. Does the wetland have organic soils, either peats or mucks that are less than 16 inches deep over bedrock, or an impermeable hardpan such as clay or volcanic ash, or that are floating on a lake or pond?    YES = go to question 3    NO = is not a bog for purpose of rating 3. Does the unit have more than 70% cover of mosses at ground level, AND other plants, if present, consist of the “bog” species listed in Table 3 as a significant component of the vegetation (more than 30% of the total shrub and herbaceous cover consists of species in Table 3)? YES = Is a bog for purpose of rating    NO = go to question 4 NOTE: If you are uncertain about the extent of mosses in the understory you may substitute that criterion by measuring the pH of the water that seeps into a hole dug at least 16” deep. If the pH is less than 5.0 and the “bog” plant species in Table 3 are present, the wetland is a bog. 4. Is the unit forested (> 30% cover) with sitka spruce, subalpine fir, western red cedar, western hemlock, lodgepole pine, quaking aspen, Englemann’s spruce, or western white pine. WITH any of the species (or combination of species) on the bog species plant list in Table 3 as a significant component of the ground cover (> 30% coverage of the total shrub/herbaceous cover)? YES = Category I    NO = Is not a bog for purpose of rating	<b>Cat. I</b>



SC4	<p><b>Forested Wetlands</b> (see p. 90)</p> <p>Does the wetland have at least 1 acre of forest that meet one of these criteria for the Department of Fish and Wildlife's forests as priority habitats? <i>If you answer yes you will still need to rate the wetland based on its function.</i></p> <p>___ <b>Old-growth forests:</b> (west of Cascade Crest) Stands of at least two three species forming a multi-layered canopy with occasional small openings; with at least 8 trees/acre (20 trees/hectare) that are at least 200 years of age OR have a diameter at breast height (dbh) of 32 inches (81 cm or more).</p> <p>NOTE: The criterion for dbh is based on measurements for upland forests. Two-hundred year old trees in wetlands will often have a smaller dbh because their growth rates are often slower. The DFW criterion is and "OR" so old-growth forests do not necessarily have to have trees of this diameter.</p> <p>___ <b>Mature forests:</b> (west of the Cascade Crest) Stands where the largest trees are 80 – 200 years old OR have an average diameters (dbh) exceeding 21 inches (53 cm); crown cover may be less than 100%; decay, decadence, numbers of snags, and quantity of large downed material is generally less than that found in old-growth.</p> <p>YES = Category I                      NO = <u>X</u> not a forested wetland with special characteristics</p>	Cat. I
SC5	<p><b>Wetlands in Coastal Lagoons</b> (see p. 91)</p> <p>Does the wetland meet all of the following criteria of a wetland in a coastal lagoon?</p> <p>___ The wetland lies in a depression adjacent to marine waters that is wholly or partially separated from marine waters by sandbanks, gravel banks, shingle, or, less frequently, rocks.</p> <p>___ The lagoon in which the wetland is located contains surface water that is saline or brackish (&gt; 0.5 ppt) during most of the year in at least a portion of the lagoon (<i>needs to be measured near the bottom.</i>)</p> <p>YES = Go to SC 5.1                      NO <u>X</u> not a wetland in a coastal lagoon</p> <p>SC 5.1 Does the wetland meet all of the following three conditions?</p> <p>___ The wetland is relatively undisturbed (has no diking, ditching, filling, cultivation, grazing) and has less than 20% cover of invasive plant species (see list of invasive species on p. 74).</p> <p>___ At least 3/4 of the landward edge of the wetland has a 100 ft. buffer of shrub, forest, or un-grazed or un-mowed grassland.</p> <p>___ The wetland is larger than 1/10 acre (4350 square ft.)</p> <p>YES = Category I                      NO = Category II</p>	Cat. I Cat. II
SC6	<p><b>Interdunal Wetlands</b> (see p. 93)</p> <p>Is the wetland west of the 1889 line (also called the Western Boundary of Upland Ownership or WBUO)?</p> <p>YES = Go to SC 6.1                      NO <u>X</u> not an interdunal wetland for rating</p> <p><i>If you answer yes you will still need to rate the wetland based on its functions.</i></p> <p>In practical terms that means the following geographic areas:</p> <ul style="list-style-type: none"> <li>• Long Beach Peninsula -- lands west of SR 103</li> <li>• Grayland-Westport -- lands west of SR 105</li> <li>• Ocean Shores-Copalis – lands west of SR 115 and SR 109</li> </ul> <p>SC 6.1 Is the wetland one acre or larger, or is it in a mosaic of wetlands that is one acre or larger?</p> <p>YES = Category II                      NO = go to SC 6.2</p> <p>SC 6.2 Is the wetland between 0.1 and 1 acre, or is it in a mosaic of wetlands that is between 0.1 and 1 acre?</p> <p>YES = Category III</p>	Cat. II Cat. III
◆	<p><b>Category of wetland based on Special Characteristics</b></p> <p>Choose the "highest" rating if wetland falls into several categories, and record on p. 1.</p> <p>If you answered NO for all types enter "Not Applicable" on p. 1</p>	NA

**Comments:**

Wetland name or number 26A

**WETLAND RATING FORM – WESTERN WASHINGTON**  
Version 2 – Updated July 2006 to increase accuracy and reproducibility among users  
Updated Oct. 2008 with the new WDFW definitions for priority habitats

Name of wetland (if known): 26A Date of site visit: 09-27-13

Rated by: Colin Worsley / Matt Maynard Trained by Ecology? Yes  No  Date of training: 11-2005 / 04-2006

SEC: 32 TOWNSHIP: 25N RANGE: 06E Is S/T/R in Appendix D? Yes  No

Map of wetland unit: Figure \_\_\_\_\_ Estimated size 0.91 acre

**SUMMARY OF RATING**

Category based on FUNCTIONS provided by wetland: I \_\_\_\_\_ II \_\_\_\_\_ III X IV \_\_\_\_\_

Category I =	Score > 70
Category II =	Score 51 - 69
Category III =	Score 30 – 50
Category IV =	Score < 30

Score for Water Quality Functions	16
Score for Hydrologic Functions	12
Score for Habitat Functions	19
<b>TOTAL Score for Functions</b>	<b>47</b>

Category based on SPECIAL CHARACTERISTICS of Wetland I \_\_\_\_\_ II \_\_\_\_\_ Does not apply X

**Final Category** (choose the “highest” category from above”) **III**

**Summary of basic information about the wetland unit.**

Wetland Unit has Special Characteristics		Wetland HGM Class used for Rating	
<b>Estuarine</b>		<b>Depressional</b>	<b>X</b>
<b>Natural Heritage Wetland</b>		<b>Riverine</b>	<b>(x)</b>
<b>Bog</b>		<b>Lake-fringe</b>	
<b>Mature Forest</b>		<b>Slope</b>	
<b>Old Growth Forest</b>		<b>Flats</b>	
<b>Coastal Lagoon</b>		<b>Freshwater Tidal</b>	
<b>Interdunal</b>			
None of the above	X	Check if unit has multiple HGM classes present	<b>X</b>

**Does the wetland being rated meet any of the criteria below?** If you answer YES to any of the questions below you will need to protect the wetland according to the regulations regarding the special characteristics found in the wetland.

Check List for Wetlands that Need Additional Protection (in addition to the protection recommended for its category)	YES	NO
SP1. <i>Has the wetland unit been documented as a habitat for any Federally listed Threatened or Endangered <b>animal or plant</b> species (T/E species)?</i> For the purposes of this rating system, “documented” means the wetland is on the appropriate state or federal database.		X
SP2. <i>Has the wetland unit been documented as habitat for any State listed Threatened or Endangered <b>animal</b> species?</i> For the purposes of this rating system, “documented” means the wetland is on the appropriate state database. Note: Wetlands with State listed plant species are categorized as Category 1 Natural Heritage Wetlands (see p. 19 of data form).		X
SP3. <i>Does the wetland unit contain individuals of Priority species listed by the WDFW for the state?</i>		X
SP4. <i>Does the wetland unit have a local significance in addition to its functions?</i> For example, the wetland has been identified in the Shoreline Master Program, the Critical Areas Ordinance, or in a local management plan as having special significance.		X

To complete the next part of the data sheet you will need to determine the Hydrogeomorphic Class of the wetland being rated.

Exhibit 16  
SSDP2016-00415  
001173

### Classification of Vegetated Wetlands for Western Washington

If the hydrologic criteria listed in each question do not apply to the entire unit being rated, you probably have a unit with multiple HGM classes. In this case, identify which hydrologic criteria in questions 1-7 apply, and go to Question 8.

1. Are the water levels in the entire unit usually controlled by tides (i.e. except during floods)?  
NO – go to 2                      **YES – the wetland class is Tidal Fringe**  
 If yes, is the salinity of the water during periods of annual low flow below 0.5 ppt (parts per thousand)?  
**YES – Freshwater Tidal Fringe**                      **NO – Saltwater Tidal Fringe (Estuarine)**  
*If your wetland can be classified as a Freshwater Tidal Fringe use the forms for Riverine wetlands. If it is a Saltwater Tidal Fringe it is rated as an Estuarine wetland. Wetlands that were call estuarine in the first and second editions of the rating system are called Salt Water Tidal Fringe in the Hydrogeomorphic Classification. Estuarine wetlands were categorized separately in the earlier editions, and this separation is being kept in this revision. To maintain consistency between editions, the term “Estuarine” wetland is kept. Please note, however, that the characteristics that define Category I and II estuarine wetlands have changed (see p. \_\_\_\_\_).*

---

2. The entire wetland unit is flat and precipitation is only source (>90%) of water to it. Groundwater and surface water runoff are NOT sources of water to the unit.  
NO – go to 3                      **YES – The wetland class is Flats**  
 If your wetland can be classified as a “Flats” wetland, use the form for **Depressional** wetlands.

---

3. Does the entire wetland meet both of the following criteria?  
 \_\_\_\_\_ The vegetated part of the wetland is on the shores of a body of permanent open water (without any vegetation on the surface) where at least 20 acres (8ha) in size;  
 \_\_\_\_\_ At least 30% of the open water area is deeper than 6.6 (2 m)?  
NO – go to 4                      **YES – The wetland class is Lake-fringe (Lacustrine Fringe)**

---

4. Does the entire wetland meet all of the following criteria?  
 \_\_\_\_\_ The wetland is on a slope (*slope can be very gradual*).  
 \_\_\_\_\_ The water flows through the wetland in one direction (unidirectional) and usually comes from seeps. It may flow subsurface, as sheetflow, or in a swale without distinct banks.  
 \_\_\_\_\_ The water leaves the wetland **without being impounded**?  
 NOTE: *Surface water does not pond in these types of wetlands except occasionally in very small and shallow depressions or behind hummocks (depressions are usually <3 ft diameter and less than 1 foot deep).*  
NO – go to 5                      **YES – The wetland class is Slope**

---

5. Does the entire wetland meet all of the following criteria?  
 \_\_\_\_\_ The unit is in a valley or stream channel where it gets inundated by overbank flooding from that stream or river.  
 \_\_\_\_\_ The overbank flooding occurs at least once every two years.  
 NOTE: *The riverine unit can contain depressions that are filled with water when the river is not flooding..*  
NO – go to 6                      **YES – The wetland class is Riverine**

---

6. Is the entire wetland unit in a topographic depression in which water ponds, or is saturated to the surface, at some time of the year. This means that any outlet, if present is higher than the interior of the wetland.  
NO – go to 7                      **YES – The wetland class is Depressional**

---

7. Is the entire wetland located in a very flat area with no obvious depression and no overbank flooding. The unit does not pond surface water more than a few inches. The unit seems to be maintained by high groundwater in the area. The wetland may be ditched, but has no obvious natural outlet.  
No – go to 8                      **YES – The wetland class is Depressional**

---

8. Your wetland unit seems to be difficult to classify and probably contains several different HGM classes. For example, seeps at the base of a slope may grade into a riverine floodplain, or a small stream within a depressional wetland has a zone of flooding along its sides. **GO BACK AND IDENTIFY WHICH OF THE HYDROLOGIC REGIMES DESCRIBED IN QUESTIONS 1-7 APPLY TO DIFFERENT AREAS IN THE UNIT** (make a rough sketch to help you decide). Use the following table to identify the appropriate class to use for the rating system if you have several HGM classes present within your wetland. NOTE: Use this table only if the class that is recommended in the second column represents 10% or more of the total area of the wetland unit being rated. If the area of the class listed in column 2 is less than 10% of the unit, classify the wetland using the class that represents more than 90% of the total area.

HGM Classes within the wetland unit being rated	HGM Class to Use in Rating
Slope + Riverine	Riverine
Slope + Depressional	Depressional
Slope + Lake-fringe	Lake-fringe
Depressional + Riverine along stream within boundary	Depressional
Depressional + Lake-fringe	Depressional
Salt Water Tidal Fringe and any other class of freshwater wetland	Treat as ESTUARINE under wetlands with special characteristics





If you are unable still to determine which of the above criteria apply to your wetland, or you have more than 2 HGM classes within a wetland boundary, classify the wetland as **Depressional** for the rating.

Exhibit 16  
SSDP2016-00415  
001174

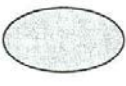

<b>D 4</b>	<p><b>Does the wetland have the <u>opportunity</u> to reduce flooding and erosion?</b></p> <p>Answer YES if the unit is in a location in the watershed where the flood storage, or reduction in water velocity, it provides helps protect downstream property and aquatic resources from flooding or excessive and/or erosive flows. Answer NO if the water coming into the wetland is controlled by a structure such as flood gate, tide gate, flap valve, reservoir etc. OR you estimate that more than 90% of the water in the wetland is from groundwater in areas where damaging groundwater flooding does not occur. <i>Note which of the following indicators of opportunity apply.</i></p> <p><input type="checkbox"/> Wetland is in a headwater of a river or stream that has flooding problems.</p> <p><input checked="" type="checkbox"/> Wetland drains to a river or stream that has flooding problems</p> <p><input type="checkbox"/> Wetland has no outlet and impounds surface runoff water that might otherwise flow into a river or stream that has flooding problems</p> <p><input type="checkbox"/> Other _____</p> <p><b>YES multiplier is 2</b>                      NO multiplier is 1</p>	<p>(see p. 49)</p> <p>Multiplier</p> <p><u>X2</u></p>
◆	<p><b>TOTAL – Hydrologic Functions</b>                      Multiply the score from D3 by D4; then <i>add score to table on p. 1</i></p>	<p>12</p>

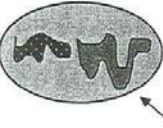
Comments:

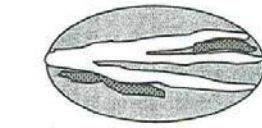
<p><i>These questions apply to wetlands of all HGM classes.</i></p> <p>HABITAT FUNCTIONS – Indicators that wetland functions to provide important habitat.</p>		<p><b>Points</b> (only 1 score per box)</p>
<p><b>H 1 Does the wetland have the potential to provide habitat for many species?</b></p>		
<p>H 1.1 <u>Vegetation structure</u> (see P. 72):                      Check the types of vegetation classes present (as defined by Cowardin) – Size threshold for each class is 1/4 acre or more than 10% of the area if unit is smaller than 2.5 acres.  <input type="checkbox"/> Aquatic Bed  <input checked="" type="checkbox"/> Emergent plants  <input checked="" type="checkbox"/> Scrub/shrub (areas where shrubs have &gt; 30% cover)  <input checked="" type="checkbox"/> Forested (areas where trees have &gt; 30% cover)                      If the unit has a forested class check if:  <input checked="" type="checkbox"/> The forested class has 3 out of 5 strata (canopy, sub-canopy, shrubs, herbaceous, moss/ground-cover) that each cover 20% within the forested polygon.                      Add the number of vegetation types that qualify. If you have: <b>Map of Cowardin vegetation classes</b>                      4 structures or more ..... points = 4                      3 structures ..... points = 2                      2 structures ..... points = 1</p>	<p><b>Figure</b> ____</p> <p>4</p>	
<p>H 1.2 <u>Hydroperiods</u> (see p.73):                      Check the types of water regimes (hydroperiods) present within the wetland. The water regime has to cover more than 10% of the wetland or 1/4 acre to count (see text for descriptions of hydroperiods).  <input type="checkbox"/> Permanently flooded or inundated  <input checked="" type="checkbox"/> Seasonally flooded or inundated  <input checked="" type="checkbox"/> Occasionally flooded or inundated  <input checked="" type="checkbox"/> Saturated only  <input checked="" type="checkbox"/> Permanently flowing stream or river in, or adjacent to, the wetland  <input type="checkbox"/> Seasonally flowing stream in, or adjacent to, the wetland  <input type="checkbox"/> Lake-fringe wetland ..... = 2 points  <input type="checkbox"/> Freshwater tidal wetland ..... = 2 points</p>	<p><b>Figure</b> ____</p> <p>3</p> <p><b>Map of hydroperiods</b></p>	
<p>H 1.3 <u>Richness of Plant Species</u> (see p. 75):                      Count the number of plant species in the wetland that cover at least 10 ft<sup>2</sup> (different patches of the same species can be combined to meet the size threshold)                      You do not have to name the species. Do not include Eurasian Milfoil, reed canarygrass, purple loosestrife, Canadian Thistle.                      If you counted: &gt; 19 species ..... points = 2                      5 – 19 species ..... points = 1                      &lt; 5 species ..... points = 0                      List species below if you want to:                      _____                      _____                      _____</p>	<p><b>Figure</b> ____</p> <p>1</p>	
<p>H 1.4 <u>Interspersion of Habitats</u> (see p. 76):                      Decided from the diagrams below whether interspersion between Cowardin vegetation (described in H1.1), or the classes and unvegetated areas (can include open water or mudflats) is high, medium, low, or none.</p> <div style="display: flex; justify-content: space-around;"> <div style="text-align: center;">  <p>None = 0 points</p> </div> <div style="text-align: center;">  <p>Low = 1 point</p> </div> <div style="text-align: center;">  <p>Moderate = 2 points</p> </div> </div> <div style="display: flex; justify-content: space-around; margin-top: 20px;"> <div style="text-align: center;">  <p>High = 3 points</p> </div> <div style="text-align: center;">  <p>High = 3 points</p> </div> <div style="text-align: center;">  <p>[riparian braided channels]</p> </div> </div> <p>Note: If you have 4 or more classes or 3 vegetation classes and open water, the rating is always “high”.  Use map of Cowardin classes.</p>	<p><b>Figure</b> ____</p> <p>3</p>	
<p>H 1.5 <u>Special Habitat Features</u> (see p. 77):                      Check the habitat features that are present in the wetland. The number of checks is the number of points you put into the next column.</p> <ul style="list-style-type: none"> <li><input type="checkbox"/> Large, downed, woody debris within the wetland (&gt; 4 in. diameter and 6 ft. long)</li> <li><input type="checkbox"/> Standing snags (diameter at the bottom &gt; 4 inches) in the wetland</li> <li><input type="checkbox"/> Undercut banks are present for at least 6.6 ft. (2m) and/or overhanging vegetation extends at least 3.3 ft. (1m) over a stream (or ditch) in, or contiguous with the unit, for at least 33 ft. (10m)</li> <li><input type="checkbox"/> Stable steep banks of fine material that might be used by beaver or muskrat for denning (&gt; 30 degree slope) OR signs of recent beaver activity are present (cut shrubs or trees that have not yet turned grey/brown)</li> <li><input type="checkbox"/> At least 1/4 acre of thin-stemmed persistent vegetation or woody branches are present in areas that are permanently or seasonally inundated (structures for egg-laying by amphibians)</li> <li><input type="checkbox"/> Invasive plants cover less than 25% of the wetland area in each stratum of plants</li> </ul> <p>NOTE: The 20% stated in early printings of the manual on page 78 is an error.</p>	<p><b>Figure</b> ____</p> <p>0</p>	
<p><b>H 1 TOTAL Score</b> – potential for providing habitat</p>		<p>Add the points in the column above</p> <p><b>11</b></p>



	<p>H 2.3 <u>Near or adjacent to other priority habitats listed by WDFW</u> (see p. 82): (see new and complete descriptions of WDFW priority habitats, and the counties in which they can be found, in the PHS report <a href="http://wdfw.wa.gov/hab/phslist.htm">http://wdfw.wa.gov/hab/phslist.htm</a> )</p> <p>Which of the following priority habitats are within 330 ft. (100m) of the wetland unit?  <i>NOTE: the connections do not have to be relatively undisturbed.</i></p> <p><input type="checkbox"/> <b>Aspen Stands:</b> Pure or mixed stands of aspen greater than 0.4 ha (1 acre).</p> <p><input type="checkbox"/> <b>Biodiversity Areas and Corridors:</b> Areas of habitat that are relatively important to various species of native fish and wildlife (full descriptions in WDFW PHS report p. 152).</p> <p><input type="checkbox"/> <b>Herbaceous Balds:</b> Variable size patches of grass and forbs on shallow soils over bedrock.</p> <p><input type="checkbox"/> <b>Old-growth/Mature forests:</b> (Old-growth west of Cascade crest) Stands of at least 2 tree species, forming a multi-layered canopy with occasional small openings; with at least 20 trees/ha (8 trees/acre) &gt; 81 cm (32 in) dbh or &gt; 200 years of age. (Mature forests) Stands with average diameters exceeding 53 cm (21 in) dbh; crown cover may be less than 100%; decay, decadence, numbers of snags, and quantity of large downed material is generally less than that found in old-growth; 80 - 200 years old west of the Cascade crest.</p> <p><input type="checkbox"/> <b>Oregon white Oak:</b> Woodlands Stands of pure oak or oak/conifer associations where canopy coverage of the oak component is important (full descriptions in WDFW PHS report p. 158).</p> <p><input checked="" type="checkbox"/> <b>Riparian:</b> The area adjacent to aquatic systems with flowing water that contains elements of both aquatic and terrestrial ecosystems which mutually influence each other.</p> <p><input type="checkbox"/> <b>Westside Prairies:</b> Herbaceous, non-forested plant communities that can either take the form of a dry prairie or a wet prairie (full descriptions in WDFW PHS report p. 161).</p> <p><input checked="" type="checkbox"/> <b>Instream:</b> The combination of physical, biological, and chemical processes and conditions that interact to provide functional life history requirements for instream fish and wildlife resources.</p> <p><input type="checkbox"/> <b>Nearshore:</b> Relatively undisturbed nearshore habitats. These include Coastal Nearshore, Open Coast Nearshore, and Puget Sound Nearshore. (full descriptions of habitats and the definition of relatively undisturbed are in WDFW report: pp. 167-169 and glossary in Appendix A).</p> <p><input type="checkbox"/> <b>Caves:</b> A naturally occurring cavity, recess, void, or system of interconnected passages under the earth in soils, rock, ice, or other geological formations and is large enough to contain a human.</p> <p><input type="checkbox"/> <b>Cliffs:</b> Greater than 7.6 m (25 ft) high and occurring below 5000 ft.</p> <p><input type="checkbox"/> <b>Talus:</b> Homogenous areas of rock rubble ranging in average size 0.15 - 2.0 m (0.5 - 6.5 ft), composed of basalt, andesite, and/or sedimentary rock, including riprap slides and mine tailings. May be associated with cliffs.</p> <p><input type="checkbox"/> <b>Snags and Logs:</b> Trees are considered snags if they are dead or dying and exhibit sufficient decay characteristics to enable cavity excavation/use by wildlife. Priority snags have a diameter at breast height of &gt; 51 cm (20 in) in western Washington and are &gt; 2 m (6.5 ft) in height. Priority logs are &gt; 30 cm (12 in) in diameter at the largest end, and &gt; 6 m (20 ft) long.</p> <p>If wetland has <b>3 or more</b> priority habitats = <b>4 points</b>  <b>If wetland has 2</b> priority habitats = <b>3 points</b>                  If wetland has <b>1</b> priority habitat = <b>1 point</b>                      No habitats = 0 points</p> <p>Note: All vegetated wetlands are by definition a priority habitat but are not included in this list. Nearby wetlands are addressed in question H 2.4)</p>	3
	<p>H 2.4 <u>Wetland Landscape:</u> Choose the <b>one</b> description of the landscape around the wetland that best fits (see p. 84)</p> <ul style="list-style-type: none"> <li>• There are at least 3 other wetlands within 1/2 mile, and the connections between them are relatively undisturbed (light grazing between wetlands OK, as is lake shore with some boating, but connections should NOT be bisected by paved roads, fill, fields, or other development.....points = 5</li> <li>• The wetland is Lake-fringe on a lake with little disturbance and there are 3 other lake-fringe wetlands within 1/2 mile .....points = 5</li> <li>• <b>There are at least 3 other wetlands within 1/2 mile, BUT the connections between them are disturbed.....points = 3</b></li> <li>• The wetland fringe on a lake <b>with</b> disturbance and there are 3 other lake-fringe wetlands within 1/2 mile .....points = 3</li> <li>• There is at least 1 wetland within 1/2 mile .....points = 2</li> <li>• There are no wetlands within 1/2 mile.....points = 0</li> </ul>	3
<p><b>H 2 TOTAL Score</b> – opportunity for providing habitat                      Add the scores from H2.1, H2.2, H2.3, H2.4</p>		8
<p style="text-align: right;"><i>TOTAL for H 1 from page 8</i></p>		11
◆	<p><b>Total Score for Habitat Functions</b>                      Add the points for H 1 and H 2; then <b>record the result on p. 1</b></p>	19

Comments:



**CATEGORIZATION BASED ON SPECIAL CHARACTERISTICS**

***Please determine if the wetland meets the attributes described below  
and circle the appropriate answers and Category.***

<b>Wetland Type</b> – Check off any criteria that apply to the wetland. Circle the Category when the appropriate criteria are met.		
<b>SC1</b>	<p><b><u>Estuarine wetlands?</u></b> (see p.86)</p> <p>Does the wetland unit meet the following criteria for Estuarine wetlands?</p> <p><input type="checkbox"/> The dominant water regime is tidal,  <input type="checkbox"/> Vegetated, and  <input type="checkbox"/> With a salinity greater than 0.5 ppt.</p> <p>YES = Go to SC 1.1                      NO <input checked="" type="checkbox"/> <u>X</u></p>	
	SC 1.1 Is the wetland unit within a National Wildlife Refuge, National Park, National Estuary Reserve, Natural Area Preserve, State Park or Educational, Environmental, or Scientific Reserve designated under WAC 332-30-151?     YES = Category I                      NO = go to SC 1.2	<b>Cat. 1</b>
	SC 1.2 Is the wetland at least 1 acre in size and meets at least two of the following conditions? <p>YES = Category I                      NO = Category II</p> <p><input type="checkbox"/> The wetland is relatively undisturbed (has no diking, ditching, filling, cultivation, grazing, and has less than 10% cover of non-native plant species. If the non-native <i>Spartina</i> spp., are only species that cover more than 10% of the wetland, then the wetland should be given a dual rating (I/II). The area of <i>Spartina</i> would be rated a Category II while the relatively undisturbed upper marsh with native species would be a Category I. Do not, however, exclude the area of <i>Spartina</i> in determining the size threshold of 1 acre.</p> <p><input type="checkbox"/> At least 3/4 of the landward edge of the wetland has a 100 ft. buffer of shrub, forest, or un-grazed or un-mowed grassland</p> <p><input type="checkbox"/> The wetland has at least 2 of the following features: tidal channels, depressions with open water, or contiguous freshwater wetlands.</p>	<b>Cat. I</b> <b>Cat. II</b> <b>Dual Rating I/II</b>
<b>SC2</b>	<p><b><u>Natural Heritage Wetlands</u></b> (see p. 87)</p> <p>Natural Heritage wetlands have been identified by the Washington Natural Heritage Program/DNR as either high quality undisturbed wetlands or wetlands that support state Threatened, Endangered, or Sensitive plant species.</p> <p>SC 2.1 Is the wetland being rated in a Section/Township/Range that contains a natural heritage wetland? (<i>This question is used to screen out most sites before you need to contact WNHP/DNR.</i>)  S/T/R information from Appendix D _____ or accessed from WNHP/DNR web site _____  YES _____ Contact WNHP/DNR (see p. 79) and go to SC 2.2     NO <input checked="" type="checkbox"/> <u>X</u></p> <p>SC 2.2 Has DNR identified the wetland as a high quality undisturbed wetland or as a site with state threatened or endangered plant species?  YES = Category 1                      NO _____ not a Heritage Wetland</p>	<b>Cat I</b>
<b>SC3</b>	<p><b><u>Bogs</u></b> (see p. 87)</p> <p>Does the wetland (<b>or any part of the unit</b>) meet both the criteria for soils and vegetation in bogs? Use the key below to identify if the wetland is a bog. <b><i>If you answer yes you will still need to rate the wetland based on its function.</i></b></p> <p>1. Does the unit have organic soil horizons (i.e. layers of organic soil), either peats or mucks, that compose 16 inches or more of the first 32 inches of soil profile? (See Appendix B for a field key to identify organic soils)?     YES = go to question 3     <b>NO = go to question 2</b></p> <p>2. Does the wetland have organic soils, either peats or mucks that are less than 16 inches deep over bedrock, or an impermeable hardpan such as clay or volcanic ash, or that are floating on a lake or pond?     YES = go to question 3     <b>NO = is not a bog for purpose of rating</b></p> <p>3. Does the unit have more than 70% cover of mosses at ground level, AND other plants, if present, consist of the “bog” species listed in Table 3 as a significant component of the vegetation (more than 30% of the total shrub and herbaceous cover consists of species in Table 3)?  YES = Is a bog for purpose of rating     NO = go to question 4</p> <p>NOTE: If you are uncertain about the extent of mosses in the understory you may substitute that criterion by measuring the pH of the water that seeps into a hole dug at least 16” deep. If the pH is less than 5.0 and the “bog” plant species in Table 3 are present, the wetland is a bog.</p> <p>4. Is the unit forested (&gt; 30% cover) with sitka spruce, subalpine fir, western red cedar, western hemlock, lodgepole pine, quaking aspen, Englemann’s spruce, or western white pine. WITH any of the species (or combination of species) on the bog species plant list in Table 3 as a significant component of the ground cover (&gt; 30% coverage of the total shrub/herbaceous cover)?  YES = Category I                      NO = Is not a bog for purpose of rating</p>	<b>Cat. I</b>

Exhibit 16  
SSDP2016-00415  
001180

SC4	<p><b>Forested Wetlands</b> (<i>see p. 90</i>)</p> <p>Does the wetland have at least 1 acre of forest that meet one of these criteria for the Department of Fish and Wildlife's forests as priority habitats? <i>If you answer yes you will still need to rate the wetland based on its function.</i></p> <p>___ <b>Old-growth forests:</b> (west of Cascade Crest) Stands of at least two three species forming a multi-layered canopy with occasional small openings; with at least 8 trees/acre (20 trees/hectare) that are at least 200 years of age OR have a diameter at breast height (dbh) of 32 inches (81 cm or more).</p> <p>NOTE: The criterion for dbh is based on measurements for upland forests. Two-hundred year old trees in wetlands will often have a smaller dbh because their growth rates are often slower. The DFW criterion is and "OR" so old-growth forests do not necessarily have to have trees of this diameter.</p> <p>___ <b>Mature forests:</b> (west of the Cascade Crest) Stands where the largest trees are 80 – 200 years old OR have an average diameters (dbh) exceeding 21 inches (53 cm); crown cover may be less than 100%; decay, decadence, numbers of snags, and quantity of large downed material is generally less than that found in old-growth.</p> <p>YES = Category I                              NO = <u>X</u> not a forested wetland with special characteristics</p>	Cat. I
SC5	<p><b>Wetlands in Coastal Lagoons</b> (<i>see p. 91</i>)</p> <p>Does the wetland meet all of the following criteria of a wetland in a coastal lagoon?</p> <p>___ The wetland lies in a depression adjacent to marine waters that is wholly or partially separated from marine waters by sandbanks, gravel banks, shingle, or, less frequently, rocks.</p> <p>___ The lagoon in which the wetland is located contains surface water that is saline or brackish (&gt; 0.5 ppt) during most of the year in at least a portion of the lagoon (<i>needs to be measured near the bottom.</i>)</p> <p>YES = Go to SC 5.1                              NO <u>X</u> not a wetland in a coastal lagoon</p> <p>SC 5.1 Does the wetland meet all of the following three conditions?</p> <p>___ The wetland is relatively undisturbed (has no diking, ditching, filling, cultivation, grazing) and has less than 20% cover of invasive plant species (see list of invasive species on p. 74).</p> <p>___ At least 3/4 of the landward edge of the wetland has a 100 ft. buffer of shrub, forest, or un-grazed or un-mowed grassland.</p> <p>___ The wetland is larger than 1/10 acre (4350 square ft.)</p> <p>YES = Category I                              NO = Category II</p>	Cat. I Cat. II
SC6	<p><b>Interdunal Wetlands</b> (<i>see p. 93</i>)</p> <p>Is the wetland west of the 1889 line (also called the Western Boundary of Upland Ownership or WBUO)?</p> <p>YES = Go to SC 6.1                              NO <u>X</u> not an interdunal wetland for rating</p> <p><b><i>If you answer yes you will still need to rate the wetland based on its functions.</i></b></p> <p>In practical terms that means the following geographic areas:</p> <ul style="list-style-type: none"> <li>• Long Beach Peninsula -- lands west of SR 103</li> <li>• Grayland-Westport -- lands west of SR 105</li> <li>• Ocean Shores-Copalis – lands west of SR 115 and SR 109</li> </ul> <p>SC 6.1 Is the wetland one acre or larger, or is it in a mosaic of wetlands that is one acre or larger?</p> <p>YES = Category II                              NO = go to SC 6.2</p> <p>SC 6.2 Is the wetland between 0.1 and 1 acre, or is it in a mosaic of wetlands that is between 0.1 and 1 acre?</p> <p>YES = Category III</p>	Cat. II Cat. III
◆	<p><b>Category of wetland based on Special Characteristics</b></p> <p><i>Choose the "highest" rating if wetland falls into several categories, and record on p. 1.</i></p> <p>If you answered NO for all types enter "Not Applicable" on p. 1</p>	NA

**Comments:**

**Exhibit 16**  
**SSDP2016-00415**  
**001181**

Wetland name or number 26B

**WETLAND RATING FORM – WESTERN WASHINGTON**  
Version 2 – Updated July 2006 to increase accuracy and reproducibility among users  
Updated Oct. 2008 with the new WDFW definitions for priority habitats

Name of wetland (if known): 26B Date of site visit: 03-20-14

Rated by: Colin Worsley / Matt Maynard Trained by Ecology? Yes X No      Date of training: 11-2005 / 04-2006

SEC: 32 TOWNSHIP: 25N RANGE: 06E Is S/T/R in Appendix D? Yes      No X

Map of wetland unit: Figure      Estimated size 0.02 acre

**SUMMARY OF RATING**

Category based on FUNCTIONS provided by wetland: I      II      III      IV X

Category I =	Score > 70
Category II =	Score 51 - 69
Category III =	Score 30 – 50
Category IV =	Score < 30

Score for Water Quality Functions	4
Score for Hydrologic Functions	0
Score for Habitat Functions	8
<b>TOTAL Score for Functions</b>	<b>12</b>

Category based on SPECIAL CHARACTERISTICS of Wetland I      II      Does not apply X

**Final Category** (choose the “highest” category from above”) **IV**

**Summary of basic information about the wetland unit.**

Wetland Unit has Special Characteristics		Wetland HGM Class used for Rating	
<b>Estuarine</b>		<b>Depressional</b>	
<b>Natural Heritage Wetland</b>		<b>Riverine</b>	
<b>Bog</b>		<b>Lake-fringe</b>	
<b>Mature Forest</b>		<b>Slope</b>	<b>X</b>
<b>Old Growth Forest</b>		<b>Flats</b>	
<b>Coastal Lagoon</b>		<b>Freshwater Tidal</b>	
<b>Interdunal</b>			
None of the above	X	Check if unit has multiple HGM classes present	<span style="border: 1px solid black; padding: 2px 10px;">    </span>

**Does the wetland being rated meet any of the criteria below?** If you answer YES to any of the questions below you will need to protect the wetland according to the regulations regarding the special characteristics found in the wetland.

Check List for Wetlands that Need Additional Protection (in addition to the protection recommended for its category)	YES	NO
SP1. <i>Has the wetland unit been documented as a habitat for any Federally listed Threatened or Endangered <b>animal or plant</b> species (T/E species)?</i> For the purposes of this rating system, “documented” means the wetland is on the appropriate state or federal database.		X
SP2. <i>Has the wetland unit been documented as habitat for any State listed Threatened or Endangered <b>animal</b> species?</i> For the purposes of this rating system, “documented” means the wetland is on the appropriate state database. Note: Wetlands with State listed plant species are categorized as Category 1 Natural Heritage Wetlands (see p. 19 of data form).		X
SP3. <i>Does the wetland unit contain individuals of Priority species listed by the WDFW for the state?</i>		X
SP4. <i>Does the wetland unit have a local significance in addition to its functions?</i> For example, the wetland has been identified in the Shoreline Master Program, the Critical Areas Ordinance, or in a local management plan as having special significance.		X

To complete the next part of the data sheet you will need to determine the Hydrogeomorphic Class of the wetland being rated.

Exhibit 16  
SSDP2016-00415  
001102

### Classification of Vegetated Wetlands for Western Washington

If the hydrologic criteria listed in each question do not apply to the entire unit being rated, you probably have a unit with multiple HGM classes. In this case, identify which hydrologic criteria in questions 1-7 apply, and go to Question 8.

1. Are the water levels in the entire unit usually controlled by tides (i.e. except during floods)?  
NO – go to 2                      YES – the wetland class is **Tidal Fringe**  
 If yes, is the salinity of the water during periods of annual low flow below 0.5 ppt (parts per thousand)?  
**YES – Freshwater Tidal Fringe**                      **NO – Saltwater Tidal Fringe (Estuarine)**  
*If your wetland can be classified as a Freshwater Tidal Fringe use the forms for **Riverine** wetlands. If it is a Saltwater Tidal Fringe it is rated as an **Estuarine** wetland. Wetlands that were call estuarine in the first and second editions of the rating system are called Salt Water Tidal Fringe in the Hydrogeomorphic Classification. Estuarine wetlands were categorized separately in the earlier editions, and this separation is being kept in this revision. To maintain consistency between editions, the term “Estuarine” wetland is kept. Please note, however, that the characteristics that define Category I and II estuarine wetlands have changed (see p. \_\_\_\_\_).*

---

2. The entire wetland unit is flat and precipitation is only source (>90%) of water to it. Groundwater and surface water runoff are NOT sources of water to the unit.  
NO – go to 3                      YES – The wetland class is **Flats**  
 If your wetland can be classified as a “Flats” wetland, use the form for **Depressional** wetlands.

---

3. Does the entire wetland meet both of the following criteria?  
 \_\_\_\_\_ The vegetated part of the wetland is on the shores of a body of permanent open water (without any vegetation on the surface) where at least 20 acres (8ha) in size;  
 \_\_\_\_\_ At least 30% of the open water area is deeper than 6.6 (2 m)?  
NO – go to 4                      YES – The wetland class is **Lake-fringe (Lacustrine Fringe)**

---

4. Does the entire wetland meet all of the following criteria?  
 The wetland is on a slope (*slope can be very gradual*).  
 The water flows through the wetland in one direction (unidirectional) and usually comes from seeps. It may flow subsurface, as sheetflow, or in a swale without distinct banks.  
 The water leaves the wetland **without being impounded?**  
*NOTE: Surface water does not pond in these types of wetlands except occasionally in very small and shallow depressions or behind hummocks (depressions are usually <3 ft diameter and less than 1 foot deep).*  
NO – go to 5                      **YES – The wetland class is Slope**

---

5. Does the entire wetland meet all of the following criteria?  
 \_\_\_\_\_ The unit is in a valley or stream channel where it gets inundated by overbank flooding from that stream or river.  
 \_\_\_\_\_ The overbank flooding occurs at least once every two years.  
*NOTE: The riverine unit can contain depressions that are filled with water when the river is not flooding..*  
NO – go to 6                      YES – The wetland class is **Riverine**

---

6. Is the entire wetland unit in a topographic depression in which water ponds, or is saturated to the surface, at some time of the year. This means that any outlet, if present is higher than the interior of the wetland.  
NO – go to 7                      YES – The wetland class is **Depressional**

---

7. Is the entire wetland located in a very flat area with no obvious depression and no overbank flooding. The unit does not pond surface water more than a few inches. The unit seems to be maintained by high groundwater in the area. The wetland may be ditched, but has no obvious natural outlet.  
No – go to 8                      YES – The wetland class is **Depressional**

---

8. Your wetland unit seems to be difficult to classify and probably contains several different HGM classes. For example, seeps at the base of a slope may grade into a riverine floodplain, or a small stream within a depressional wetland has a zone of flooding along its sides. **GO BACK AND IDENTIFY WHICH OF THE HYDROLOGIC REGIMES DESCRIBED IN QUESTIONS 1-7 APPLY TO DIFFERENT AREAS IN THE UNIT** (make a rough sketch to help you decide). Use the following table to identify the appropriate class to use for the rating system if you have several HGM classes present within your wetland. *NOTE: Use this table only if the class that is recommended in the second column represents 10% or more of the total area of the wetland unit being rated. If the area of the class listed in column 2 is less than 10% of the unit, classify the wetland using the class that represents more than 90% of the total area.*

HGM Classes within the wetland unit being rated	HGM Class to Use in Rating
Slope + Riverine	Riverine
Slope + Depressional	Depressional
Slope + Lake-fringe	Lake-fringe
Depressional + Riverine along stream within boundary	Depressional
Depressional + Lake-fringe	Depressional
Salt Water Tidal Fringe and any other class of freshwater wetland	Treat as ESTUARINE under wetlands with special characteristics

Exhibit 16  
SSDP2016-00415  
001183

If you are unable still to determine which of the above criteria apply to your wetland, or you have more than 2 HGM classes within a wetland boundary, classify the wetland as **Depressional** for the rating.

<b>S Slope Wetlands</b>		<b>Points</b>
<b>WATER QUALITY FUNCTIONS – Indicators that wetland functions to improve water quality.</b>		(only 1 score per box) (see p.64)
<b>S 1</b>	<b>Does the wetland have the <u>potential</u> to improve water quality?</b>	
S 1.1	Characteristics of average slope of unit: • Slope is 1% or less (a 1% slope has a 1 ft. vertical drop in elevation for every 100 ft. horizontal distance)..... points = 3 • Slope is 1% - 2% ..... points = 2 • Slope is 2% - 5% ..... points = 1 • Slope is greater than 5% ..... points = 0	2
S 1.2	The soil 2 inches below the surface (or duff layer) is clay, organic (Use NRCS definitions). YES = 3 points                      NO = 0 points	0
S 1.3	Characteristics of the vegetation in the wetland that trap sediments and pollutants: Choose the points appropriate for the description that best fits the vegetation in the wetland. Dense vegetation means you have trouble seeing the soil surface (>75% cover), and uncut means not grazed or mowed and plants are higher than 6 inches. • Dense, uncut, herbaceous vegetation > 90% of the wetland area..... points = 6 • Dense, uncut, herbaceous vegetation > 1/2 of area ..... points = 3 • Dense, woody, vegetation > 1/2 of area..... points = 2 • Dense, uncut, herbaceous vegetation > 1/4 of area ..... points = 1 • Does not meet any of the criteria above for vegetation ..... points = 0 Aerial photo or map with vegetation polygons	Figure ____  0
<b>Total for S 1</b>		Add the points in the boxes above
		2
<b>S 2</b>	<b>Does the wetland have the <u>opportunity</u> to improve water quality?</b>	(see p. 67)
Answer YES if you know or believe there are pollutants in groundwater or surface water coming into the wetland that would otherwise reduce water quality in streams, lakes or groundwater downgradient from the wetland? Note which of the following conditions provide the sources of pollutants. A unit may have pollutants coming from several sources, but any single source would qualify as opportunity. _____ Grazing in the wetland or within 150 ft _____ Untreated stormwater discharges to wetland _____ Tilled fields, logging, or orchards within 150 ft. of wetland <u> X </u> Residential, urban areas, or golf courses are within 150 ft. upslope of wetland _____ Other _____ YES multiplier is 2                      NO multiplier is 1		Multiplier  X2
<b>◆ TOTAL – Water Quality Functions</b>		Multiply the score from S1 by S2; then add score to table on p. 1
		4
<b>HYDROLOGIC FUNCTIONS – Indicators that wetland functions to reduce flooding and stream erosion.</b>		
<b>S 3</b>	<b>Does the wetland have the <u>potential</u> to reduce flooding and stream erosion?</b>	(see p.68)
S 3.1	Characteristics of vegetation that reduce the velocity of surface flows during storms: Choose the points appropriate for the description that best fits conditions in the wetland (stems of plants should be thick enough (usually > 1/8in), or dense enough to remain erect during surface flows). • Dense, uncut, rigid vegetation covers > 90% of the area of the wetland ..... points = 6 • Dense, uncut, rigid vegetation > 1/2 area of wetland..... points = 3 • Dense, uncut, rigid vegetation > 1/4 area..... points = 1 • More than 1/4 of area is grazed, mowed, tilled, or vegetation is not rigid ..... points = 0	0
S 3.2	Characteristics of slope wetland that holds back small amounts of flood flows. The slope has small surface depressions that can retain water over at least 10% of its area. YES = 2 points                      NO = 0 points	0
Add the points in the boxes above		0
<b>S 4</b>	<b>Does the wetland have the <u>opportunity</u> to reduce flooding and erosion?</b>	(see p. 70)
Is the wetland in a landscape position where the reduction in water velocity it provides helps protect downstream property and aquatic resources from flooding or excessive and/or erosive flows? Note which of the following conditions apply. _____ Wetland has surface runoff that drains to a river or stream that has flooding problems _____ Other _____ (Answer NO if the major source of water is controlled by a reservoir (e.g. wetland is a seep that is on the downstream side of a dam) YES multiplier is 2                      NO multiplier is 1		Multiplier  X1
<b>◆ TOTAL – Hydrologic Functions</b>		Multiply the score from S3 by S4; then add score to table on p. 1
		0

**Comments:** Wetland A is adjacent to estuarine wetland but separate in that Wetland A is not influenced by salt water. Freshwater flows through Wetland A in one direction and enters North Bay.





These questions apply to wetlands of all HGM classes.		Points (only 1 score per box)
HABITAT FUNCTIONS – Indicators that wetland functions to provide important habitat.		
<b>H 1</b>	<b>Does the wetland have the <u>potential</u> to provide habitat for many species?</b>	
H 1.1	<p><u>Vegetation structure</u> (see P. 72): Check the types of vegetation classes present (as defined by Cowardin) – Size threshold for each class is 1/4 acre or more than 10% of the area if unit is smaller than 2.5 acres.</p> <p><input type="checkbox"/> Aquatic Bed <input checked="" type="checkbox"/> Emergent plants <input type="checkbox"/> Scrub/shrub (areas where shrubs have &gt; 30% cover) <input type="checkbox"/> Forested (areas where trees have &gt; 30% cover) If the unit has a forested class check if: <input type="checkbox"/> The forested class has 3 out of 5 strata (canopy, sub-canopy, shrubs, herbaceous, moss/ground-cover) that each cover 20% within the forested polygon. Add the number of vegetation types that qualify. If you have:</p> <p style="text-align: right;"><b>Map of Cowardin vegetation classes</b> 3 structures ..... points = 2 1 structure ..... points = 0</p>	Figure ____  0
H 1.2	<p><u>Hydroperiods</u> (see p.73): Check the types of water regimes (hydroperiods) present within the wetland. The water regime has to cover more than 10% of the wetland or 1/4 acre to count (see text for descriptions of hydroperiods).</p> <p><input type="checkbox"/> Permanently flooded or inundated <input type="checkbox"/> Seasonally flooded or inundated <input type="checkbox"/> Occasionally flooded or inundated <input checked="" type="checkbox"/> Saturated only <input type="checkbox"/> Permanently flowing stream or river in, or adjacent to, the wetland <input type="checkbox"/> Seasonally flowing stream in, or adjacent to, the wetland <input type="checkbox"/> Lake-fringe wetland ..... = 2 points <input type="checkbox"/> Freshwater tidal wetland ..... = 2 points</p> <p style="text-align: right;"><b>Map of hydroperiods</b> 4 or more types present points = 3 3 or more types present ..... points = 2 2 types present ..... points = 1 1 type present ..... points = 0</p>	Figure ____  0
H 1.3	<p><u>Richness of Plant Species</u> (see p. 75): Count the number of plant species in the wetland that cover at least 10 ft<sup>2</sup> (different patches of the same species can be combined to meet the size threshold) You do not have to name the species. Do not include Eurasian Milfoil, reed canarygrass, purple loosestrife, Canadian Thistle. If you counted: &gt; 19 species ..... points = 2 5 – 19 species ..... points = 1 &lt; 5 species ..... points = 0</p> <p>List species below if you want to: _____ _____ _____</p>	0
H 1.4	<p><u>Interspersion of Habitats</u> (see p. 76): Decided from the diagrams below whether interspersion between Cowardin vegetation (described in H1.1), or the classes and unvegetated areas (can include open water or mudflats) is high, medium, low, or none.</p> <div style="display: flex; justify-content: space-around;"> <div style="text-align: center;">  None = 0 points         </div> <div style="text-align: center;">  Low = 1 point         </div> <div style="text-align: center;">  Moderate = 2 points         </div> <div style="text-align: center;">  High = 3 points         </div> </div> <p style="text-align: right;">Note: If you have 4 or more classes or 3 vegetation classes and open water, the rating is always "high".</p> <p style="text-align: center;"><b>Use map of Cowardin classes.</b></p> <p style="text-align: right;">[riparian braided channels]</p>	Figure ____  0
H 1.5	<p><u>Special Habitat Features</u> (see p. 77): Check the habitat features that are present in the wetland. The number of checks is the number of points you put into the next column.</p> <p><input type="checkbox"/> Large, downed, woody debris within the wetland (&gt; 4 in. diameter and 6 ft. long) <input type="checkbox"/> Standing snags (diameter at the bottom &gt; 4 inches) in the wetland <input type="checkbox"/> Undercut banks are present for at least 6.6 ft. (2m) and/or overhanging vegetation extends at least 3.3 ft. (1m) over a stream (or ditch) in, or contiguous with the unit, for at least 33 ft. (10m) <input type="checkbox"/> Stable steep banks of fine material that might be used by beaver or muskrat for denning (&gt; 30 degree slope) OR signs of recent beaver activity are present (cut shrubs or trees that have not yet turned grey/brown) <input type="checkbox"/> At least 1/4 acre of thin-stemmed persistent vegetation or woody branches are present in areas that are permanently or seasonally inundated (structures for egg-laying by amphibians) <input type="checkbox"/> Invasive plants cover less than 25% of the wetland area in each stratum of plants NOTE: The 20% stated in early printings of the manual on page 78 is an error.</p>	0
<b>H 1 TOTAL Score</b> – potential for providing habitat		0

Exhibit 16  
SSP 2015-00215  
001185



	<p>H 2.3 <u>Near or adjacent to other priority habitats listed by WDFW</u> (see p. 82): (see new and complete descriptions of WDFW priority habitats, and the counties in which they can be found, in the PHS report <a href="http://wdfw.wa.gov/hab/phslist.htm">http://wdfw.wa.gov/hab/phslist.htm</a> )</p> <p>Which of the following priority habitats are within 330 ft. (100m) of the wetland unit?  <i>NOTE: the connections do not have to be relatively undisturbed.</i></p> <p><input type="checkbox"/> <b>Aspen Stands:</b> Pure or mixed stands of aspen greater than 0.4 ha (1 acre).</p> <p><input type="checkbox"/> <b>Biodiversity Areas and Corridors:</b> Areas of habitat that are relatively important to various species of native fish and wildlife (full descriptions in WDFW PHS report p. 152).</p> <p><input type="checkbox"/> <b>Herbaceous Balds:</b> Variable size patches of grass and forbs on shallow soils over bedrock.</p> <p><input type="checkbox"/> <b>Old-growth/Mature forests:</b> (Old-growth west of Cascade crest) Stands of at least 2 tree species, forming a multi-layered canopy with occasional small openings; with at least 20 trees/ha (8 trees/acre) &gt; 81 cm (32 in) dbh or &gt; 200 years of age. (Mature forests) Stands with average diameters exceeding 53 cm (21 in) dbh; crown cover may be less than 100%; decay, decadence, numbers of snags, and quantity of large downed material is generally less than that found in old-growth; 80 - 200 years old west of the Cascade crest.</p> <p><input type="checkbox"/> <b>Oregon white Oak:</b> Woodlands Stands of pure oak or oak/conifer associations where canopy coverage of the oak component is important (full descriptions in WDFW PHS report p. 158).</p> <p><input checked="" type="checkbox"/> <b>Riparian:</b> The area adjacent to aquatic systems with flowing water that contains elements of both aquatic and terrestrial ecosystems which mutually influence each other.</p> <p><input type="checkbox"/> <b>Westside Prairies:</b> Herbaceous, non-forested plant communities that can either take the form of a dry prairie or a wet prairie (full descriptions in WDFW PHS report p. 161).</p> <p><input checked="" type="checkbox"/> <b>Instream:</b> The combination of physical, biological, and chemical processes and conditions that interact to provide functional life history requirements for instream fish and wildlife resources.</p> <p><input type="checkbox"/> <b>Nearshore:</b> Relatively undisturbed nearshore habitats. These include Coastal Nearshore, Open Coast Nearshore, and Puget Sound Nearshore. (full descriptions of habitats and the definition of relatively undisturbed are in WDFW report: pp. 167-169 and glossary in Appendix A).</p> <p><input type="checkbox"/> <b>Caves:</b> A naturally occurring cavity, recess, void, or system of interconnected passages under the earth in soils, rock, ice, or other geological formations and is large enough to contain a human.</p> <p><input type="checkbox"/> <b>Cliffs:</b> Greater than 7.6 m (25 ft) high and occurring below 5000 ft.</p> <p><input type="checkbox"/> <b>Talus:</b> Homogenous areas of rock rubble ranging in average size 0.15 - 2.0 m (0.5 - 6.5 ft), composed of basalt, andesite, and/or sedimentary rock, including riprap slides and mine tailings. May be associated with cliffs.</p> <p><input type="checkbox"/> <b>Snags and Logs:</b> Trees are considered snags if they are dead or dying and exhibit sufficient decay characteristics to enable cavity excavation/use by wildlife. Priority snags have a diameter at breast height of &gt; 51 cm (20 in) in western Washington and are &gt; 2 m (6.5 ft) in height. Priority logs are &gt; 30 cm (12 in) in diameter at the largest end, and &gt; 6 m (20 ft) long.</p> <p>If wetland has <b>3 or more</b> priority habitats = <b>4 points</b>                  If wetland has <b>2</b> priority habitats = <b>3 points</b>                  If wetland has <b>1</b> priority habitat = <b>1 point</b>                      No habitats = 0 points</p> <p>Note: All vegetated wetlands are by definition a priority habitat but are not included in this list. Nearby wetlands are addressed in question H 2.4)</p>	3
	<p>H 2.4 <u>Wetland Landscape:</u> Choose the <b>one</b> description of the landscape around the wetland that best fits (see p. 84)</p> <ul style="list-style-type: none"> <li>• There are at least 3 other wetlands within 1/2 mile, and the connections between them are relatively undisturbed (light grazing between wetlands OK, as is lake shore with some boating, but connections should NOT be bisected by paved roads, fill, fields, or other development.....points = 5</li> <li>• The wetland is Lake-fringe on a lake with little disturbance and there are 3 other lake-fringe wetlands within 1/2 mile .....points = 5</li> <li>• There are at least 3 other wetlands within 1/2 mile, BUT the connections between them are disturbed. ....points = 3</li> <li>• The wetland fringe on a lake <b>with</b> disturbance and there are 3 other lake-fringe wetlands within 1/2 mile .....points = 3</li> <li>• There is at least 1 wetland within 1/2 mile .....points = 2</li> <li>• There are no wetlands within 1/2 mile.....points = 0</li> </ul>	3
	<p><b>H 2 TOTAL Score</b> – opportunity for providing habitat                      <i>Add the scores from H2.1, H2.2, H2.3, H2.4</i></p>	8
	<p style="text-align: right;"><i>TOTAL for H 1 from page 8</i></p>	0
◆	<p><b>Total Score for Habitat Functions</b>                      Add the points for H 1 and H 2; then <b>record the result on p. 1</b></p>	8

Comments:







Wetland name or number 26C

**WETLAND RATING FORM – WESTERN WASHINGTON**  
Version 2 – Updated July 2006 to increase accuracy and reproducibility among users  
Updated Oct. 2008 with the new WDFW definitions for priority habitats

Name of wetland (if known): 26C Date of site visit: 03-20-14

Rated by: Colin Worsley / Matt Maynard Trained by Ecology? Yes X No      Date of training: 11-2005 / 04-2006

SEC: 32 TOWNSHIP: 25N RANGE: 06E Is S/T/R in Appendix D? Yes      No X

Map of wetland unit: Figure                      Estimated size 0.91 acre

**SUMMARY OF RATING**

Category based on FUNCTIONS provided by wetland: I      II      III      IV X

Category I =	Score > 70
Category II =	Score 51 - 69
Category III =	Score 30 – 50
Category IV =	Score < 30

Score for Water Quality Functions	4
Score for Hydrologic Functions	12
Score for Habitat Functions	11
<b>TOTAL Score for Functions</b>	<b>27</b>

Category based on SPECIAL CHARACTERISTICS of Wetland I      II      Does not apply X

**Final Category** (choose the “highest” category from above”) **IV**

**Summary of basic information about the wetland unit.**

Wetland Unit has Special Characteristics		Wetland HGM Class used for Rating	
<b>Estuarine</b>		<b>Depressional</b>	<b>X</b>
<b>Natural Heritage Wetland</b>		<b>Riverine</b>	
<b>Bog</b>		<b>Lake-fringe</b>	
<b>Mature Forest</b>		<b>Slope</b>	
<b>Old Growth Forest</b>		<b>Flats</b>	
<b>Coastal Lagoon</b>		<b>Freshwater Tidal</b>	
<b>Interdunal</b>			
None of the above	X	Check if unit has multiple HGM classes present	<span style="border: 1px solid black; padding: 2px 5px;">  </span>

**Does the wetland being rated meet any of the criteria below?** If you answer YES to any of the questions below you will need to protect the wetland according to the regulations regarding the special characteristics found in the wetland.

Check List for Wetlands that Need Additional Protection (in addition to the protection recommended for its category)		YES	NO
SP1. <i>Has the wetland unit been documented as a habitat for any Federally listed Threatened or Endangered <b>animal or plant</b> species (T/E species)?</i> For the purposes of this rating system, “documented” means the wetland is on the appropriate state or federal database.			X
SP2. <i>Has the wetland unit been documented as habitat for any State listed Threatened or Endangered <b>animal</b> species?</i> For the purposes of this rating system, “documented” means the wetland is on the appropriate state database. Note: Wetlands with State listed plant species are categorized as Category 1 Natural Heritage Wetlands (see p. 19 of data form).			X
SP3. <i>Does the wetland unit contain individuals of Priority species listed by the WDFW for the state?</i>			X
SP4. <i>Does the wetland unit have a local significance in addition to its functions?</i> For example, the wetland has been identified in the Shoreline Master Program, the Critical Areas Ordinance, or in a local management plan as having special significance.			X

To complete the next part of the data sheet you will need to determine the Hydrogeomorphic Class of the wetland being rated.

Exhibit 16  
SSDP2016-00415  
001190

### Classification of Vegetated Wetlands for Western Washington

If the hydrologic criteria listed in each question do not apply to the entire unit being rated, you probably have a unit with multiple HGM classes. In this case, identify which hydrologic criteria in questions 1-7 apply, and go to Question 8.

1. Are the water levels in the entire unit usually controlled by tides (i.e. except during floods)?  
**NO – go to 2**                      **YES – the wetland class is Tidal Fringe**  
 If yes, is the salinity of the water during periods of annual low flow below 0.5 ppt (parts per thousand)?  
    **YES – Freshwater Tidal Fringe**                      **NO – Saltwater Tidal Fringe (Estuarine)**  
*If your wetland can be classified as a Freshwater Tidal Fringe use the forms for Riverine wetlands. If it is a Saltwater Tidal Fringe it is rated as an Estuarine wetland. Wetlands that were call estuarine in the first and second editions of the rating system are called Salt Water Tidal Fringe in the Hydrogeomorphic Classification. Estuarine wetlands were categorized separately in the earlier editions, and this separation is being kept in this revision. To maintain consistency between editions, the term “Estuarine” wetland is kept. Please note, however, that the characteristics that define Category I and II estuarine wetlands have changed (see p. \_\_\_\_\_).*

2. The entire wetland unit is flat and precipitation is only source (>90%) of water to it. Groundwater and surface water runoff are NOT sources of water to the unit.  
    **NO – go to 3**                      **YES – The wetland class is Flats**  
 If your wetland can be classified as a “Flats” wetland, use the form for **Depressional** wetlands.

3. Does the entire wetland meet both of the following criteria?  
 \_\_\_\_\_ The vegetated part of the wetland is on the shores of a body of permanent open water (without any vegetation on the surface) where at least 20 acres (8ha) in size;  
 \_\_\_\_\_ At least 30% of the open water area is deeper than 6.6 (2 m)?  
    **NO – go to 4**                      **YES – The wetland class is Lake-fringe (Lacustrine Fringe)**

4. Does the entire wetland meet all of the following criteria?  
 \_\_\_\_\_ The wetland is on a slope (*slope can be very gradual*).  
 \_\_\_\_\_ The water flows through the wetland in one direction (unidirectional) and usually comes from seeps. It may flow subsurface, as sheetflow, or in a swale without distinct banks.  
 \_\_\_\_\_ The water leaves the wetland **without being impounded**?  
 NOTE: *Surface water does not pond in these types of wetlands except occasionally in very small and shallow depressions or behind hummocks (depressions are usually <3 ft diameter and less than 1 foot deep).*  
    **NO – go to 5**                      **YES – The wetland class is Slope**

5. Does the entire wetland meet all of the following criteria?  
 \_\_\_\_\_ The unit is in a valley or stream channel where it gets inundated by overbank flooding from that stream or river.  
 \_\_\_\_\_ The overbank flooding occurs at least once every two years.  
 NOTE: *The riverine unit can contain depressions that are filled with water when the river is not flooding..*  
    **NO – go to 6**                      **YES – The wetland class is Riverine**

6. Is the entire wetland unit in a topographic depression in which water ponds, or is saturated to the surface, at some time of the year. This means that any outlet, if present is higher than the interior of the wetland.  
    **NO – go to 7**                      **YES – The wetland class is Depressional**

7. Is the entire wetland located in a very flat area with no obvious depression and no overbank flooding. The unit does not pond surface water more than a few inches. The unit seems to be maintained by high groundwater in the area. The wetland may be ditched, but has no obvious natural outlet.  
    **No – go to 8**                      **YES – The wetland class is Depressional**

8. Your wetland unit seems to be difficult to classify and probably contains several different HGM classes. For example, seeps at the base of a slope may grade into a riverine floodplain, or a small stream within a depressional wetland has a zone of flooding along its sides. **GO BACK AND IDENTIFY WHICH OF THE HYDROLOGIC REGIMES DESCRIBED IN QUESTIONS 1-7 APPLY TO DIFFERENT AREAS IN THE UNIT** (make a rough sketch to help you decide). Use the following table to identify the appropriate class to use for the rating system if you have several HGM classes present within your wetland. NOTE: Use this table only if the class that is recommended in the second column represents 10% or more of the total area of the wetland unit being rated. If the area of the class listed in column 2 is less than 10% of the unit, classify the wetland using the class that represents more than 90% of the total area.

HGM Classes within the wetland unit being rated	HGM Class to Use in Rating
Slope + Riverine	Riverine
Slope + Depressional	Depressional
Slope + Lake-fringe	Lake-fringe
Depressional + Riverine along stream within boundary	Depressional
Depressional + Lake-fringe	Depressional
Salt Water Tidal Fringe and any other class of freshwater wetland	Treat as ESTUARINE under wetlands with special characteristics

Exhibit 16  
SSDP2016-00415  
001191

If you are unable still to determine which of the above criteria apply to your wetland, or you have more than 2 HGM classes within a wetland boundary, classify the wetland as **Depressional** for the rating.

<b>D Depressional and Flat Wetlands</b>		<b>Points</b>
WATER QUALITY FUNCTIONS – Indicators that wetland functions to improve water quality.		(only 1 score per box) (see p.38)
<b>D 1</b>	<b>Does the wetland have the <u>potential</u> to improve water quality?</b>	
D 1.1	Characteristics of surface water flows out of the wetland: • Unit is a depression with no surface water leaving it (no outlet)..... points = 3 • Unit has an intermittently flowing, OR highly constricted, permanently flowing outlet ..... points = 2 • Unit has an unconstricted, or slightly constricted, surface outlet ( <i>permanently flowing</i> ) ..... points = 1 • Unit is a “flat” depression (Q.7 on key), or in the Flats class, with permanent surface outflow and no obvious natural outlet and/or outlet is a man-made ditch..... points = 1 (If ditch is not permanently flowing treat unit as “intermittently flowing”) <b>Provide photo or drawing</b>	Figure ____ 1
D 1.2	The soil 2 inches below the surface (or duff layer) is clay or organic ( <i>use NRCS definitions</i> ) YES points = 4 NO points = 0	0
D 1.3	Characteristics of persistent vegetation (emergent, shrub, and/or forest Cowardin class): • Wetland has persistent, ungrazed vegetation > = 95% of area..... points = 5 • Wetland has persistent, ungrazed vegetation > = 1/2 of area..... points = 3 • Wetland has persistent, ungrazed vegetation > = 1/10 of area..... points = 1 • Wetland has persistent, ungrazed vegetation < 1/10 of area..... points = 0 <b>Map of Cowardin vegetation classes</b>	Figure ____ 1
D 1.4	Characteristics of seasonal ponding or inundation: <i>This is the area of the wetland that is ponded for at least 2 months, but dries out sometime during the year. Do not count the area that is permanently ponded. Estimate area as the average condition 5 out of 10 years.</i> • Area seasonally ponded is > 1/2 total area of wetland ..... points = 4 • Area seasonally ponded is > 1/4 total area of wetland ..... points = 2 • Area seasonally ponded is < 1/4 total area of wetland ..... points = 0 <b>Map of Hydroperiods</b>	Figure ____ 0
<b>Total for D 1</b>		Add the points in the boxes above <b>2</b>
<b>D 2</b>	<b>Does the wetland have the <u>opportunity</u> to improve water quality?</b>	(see p. 44)
Answer YES if you know or believe there are pollutants in groundwater or surface water coming into the wetland that would otherwise reduce water quality in streams, lakes or groundwater downgradient from the wetland? <i>Note which of the following conditions provide the sources of pollutants. A unit may have pollutants coming from several sources, but any single source would qualify as opportunity.</i> ___ Grazing in the wetland or within 150 ft ___ Untreated stormwater discharges to wetland ___ Tilled fields or orchards within 150 ft. of wetland ___ A stream or culvert discharges into wetland that drains developed areas, residential areas, farmed fields, roads, or clear-cut logging <u>X</u> Residential, urban areas, golf courses are within 150 ft. of wetland ___ Wetland is fed by groundwater high in phosphorus or nitrogen ___ Other _____ YES multiplier is 2 NO multiplier is 1		Multiplier X2
◆ <b>TOTAL – Water Quality Functions</b> Multiply the score from D1 by D2; then <i>add score to table on p. 1</i>		4
HYDROLOGIC FUNCTIONS – Indicators that wetland unit functions to reduce flooding and stream degradation.		
<b>D 3</b>	<b>Does the wetland have the <u>potential</u> to reduce flooding and erosion?</b>	(see p.46)
D 3.1	Characteristics of surface water flows out of the wetland unit • Unit is a depression with no surface water leaving it (no outlet)..... points = 4 • Unit has an intermittently flowing, OR highly constricted permanently flowing outlet ..... points = 2 • Unit is a “flat” depression (Q.7 on key) or in the Flats class, with permanent surface outflow and no obvious natural outlet and/or outlet is a man-made ditch..... points = 1 (If ditch is not permanently flowing treat unit as “intermittently flowing”) • Unit has an unconstricted, or slightly constricted, surface outlet ( <i>permanently flowing</i> ) ..... points = 0	1
D 3.2	Depth of storage during wet periods. <i>Estimate the height of ponding above the bottom of the outlet. For units with no outlet measure from the surface of permanent water or deepest part (if dry).</i> • Marks of ponding are 3 ft. or more above the surface or bottom of the outlet ..... points = 7 • The wetland is a “headwater” wetland..... points = 5 • Marks of ponding between 2 ft. to < 3 ft. from surface or bottom of outlet ..... points = 5 • Marks are at least 0.5 ft. to < 2 ft. from surface or bottom of outlet ..... points = 3 • Wetland is flat (yes to Q.2 or Q.7 on key)but has small depressions on the surface that trap water points = 1 • Marks of ponding less than 0.5 ft ..... points = 0	0
D 3.3	Contribution of wetland unit to storage in the watershed: <i>Estimate the ratio of the area of upstream basin contributing surface water to the wetland to the area of the wetland unit itself.</i> • The area of the basin is less than 10 times the area of unit..... points = 5 • The area of the basin is 10 to 100 times the area of the unit ..... points = 3 • The area of the basin is more than 100 times the area of the unit ..... points = 0 • Entire unit is in the FLATS class ..... points = 5	5
<b>Total for D 3</b>		Add the points in the boxes above <b>6</b>

**Exhibit 16**  
**SSDP2016-00415**  
**001192**

<b>D 4</b>	<p><b>Does the wetland have the <u>opportunity</u> to reduce flooding and erosion?</b></p> <p>Answer YES if the unit is in a location in the watershed where the flood storage, or reduction in water velocity, it provides helps protect downstream property and aquatic resources from flooding or excessive and/or erosive flows. Answer NO if the water coming into the wetland is controlled by a structure such as flood gate, tide gate, flap valve, reservoir etc. OR you estimate that more than 90% of the water in the wetland is from groundwater in areas where damaging groundwater flooding does not occur. <i>Note which of the following indicators of opportunity apply.</i></p> <p><input type="checkbox"/> Wetland is in a headwater of a river or stream that has flooding problems.</p> <p><input type="checkbox"/> Wetland drains to a river or stream that has flooding problems</p> <p><input type="checkbox"/> Wetland has no outlet and impounds surface runoff water that might otherwise flow into a river or stream that has flooding problems</p> <p><input type="checkbox"/> Other _____</p> <p><b>YES multiplier is 2</b>                      NO multiplier is 1</p>	<p>(see p. 49)</p> <p>Multiplier</p> <p><u>X2</u></p>
◆	<p><b>TOTAL – Hydrologic Functions</b>                      Multiply the score from D3 by D4; then <i>add score to table on p. 1</i></p>	<p>12</p>

Comments:







	<p>H 2.3 <u>Near or adjacent to other priority habitats listed by WDFW</u> (see p. 82): (see new and complete descriptions of WDFW priority habitats, and the counties in which they can be found, in the PHS report <a href="http://wdfw.wa.gov/hab/phslist.htm">http://wdfw.wa.gov/hab/phslist.htm</a>)</p> <p>Which of the following priority habitats are within 330 ft. (100m) of the wetland unit?  <i>NOTE: the connections do not have to be relatively undisturbed.</i></p> <p><input type="checkbox"/> <b>Aspen Stands:</b> Pure or mixed stands of aspen greater than 0.4 ha (1 acre).</p> <p><input type="checkbox"/> <b>Biodiversity Areas and Corridors:</b> Areas of habitat that are relatively important to various species of native fish and wildlife (full descriptions in WDFW PHS report p. 152).</p> <p><input type="checkbox"/> <b>Herbaceous Balds:</b> Variable size patches of grass and forbs on shallow soils over bedrock.</p> <p><input type="checkbox"/> <b>Old-growth/Mature forests:</b> (Old-growth west of Cascade crest) Stands of at least 2 tree species, forming a multi-layered canopy with occasional small openings; with at least 20 trees/ha (8 trees/acre) &gt; 81 cm (32 in) dbh or &gt; 200 years of age. (Mature forests) Stands with average diameters exceeding 53 cm (21 in) dbh; crown cover may be less than 100%; decay, decadence, numbers of snags, and quantity of large downed material is generally less than that found in old-growth; 80 - 200 years old west of the Cascade crest.</p> <p><input type="checkbox"/> <b>Oregon white Oak:</b> Woodlands Stands of pure oak or oak/conifer associations where canopy coverage of the oak component is important (full descriptions in WDFW PHS report p. 158).</p> <p><input checked="" type="checkbox"/> <b>Riparian:</b> The area adjacent to aquatic systems with flowing water that contains elements of both aquatic and terrestrial ecosystems which mutually influence each other.</p> <p><input type="checkbox"/> <b>Westside Prairies:</b> Herbaceous, non-forested plant communities that can either take the form of a dry prairie or a wet prairie (full descriptions in WDFW PHS report p. 161).</p> <p><input checked="" type="checkbox"/> <b>Instream:</b> The combination of physical, biological, and chemical processes and conditions that interact to provide functional life history requirements for instream fish and wildlife resources.</p> <p><input type="checkbox"/> <b>Nearshore:</b> Relatively undisturbed nearshore habitats. These include Coastal Nearshore, Open Coast Nearshore, and Puget Sound Nearshore. (full descriptions of habitats and the definition of relatively undisturbed are in WDFW report: pp. 167-169 and glossary in Appendix A).</p> <p><input type="checkbox"/> <b>Caves:</b> A naturally occurring cavity, recess, void, or system of interconnected passages under the earth in soils, rock, ice, or other geological formations and is large enough to contain a human.</p> <p><input type="checkbox"/> <b>Cliffs:</b> Greater than 7.6 m (25 ft) high and occurring below 5000 ft.</p> <p><input type="checkbox"/> <b>Talus:</b> Homogenous areas of rock rubble ranging in average size 0.15 - 2.0 m (0.5 - 6.5 ft), composed of basalt, andesite, and/or sedimentary rock, including riprap slides and mine tailings. May be associated with cliffs.</p> <p><input type="checkbox"/> <b>Snags and Logs:</b> Trees are considered snags if they are dead or dying and exhibit sufficient decay characteristics to enable cavity excavation/use by wildlife. Priority snags have a diameter at breast height of &gt; 51 cm (20 in) in western Washington and are &gt; 2 m (6.5 ft) in height. Priority logs are &gt; 30 cm (12 in) in diameter at the largest end, and &gt; 6 m (20 ft) long.</p> <p>If wetland has <b>3 or more</b> priority habitats = <b>4 points</b>  <b>If wetland has 2</b> priority habitats = <b>3 points</b>                  If wetland has <b>1</b> priority habitat = <b>1 point</b>                      No habitats = 0 points</p> <p>Note: All vegetated wetlands are by definition a priority habitat but are not included in this list. Nearby wetlands are addressed in question H 2.4)</p>	3
	<p>H 2.4 <u>Wetland Landscape:</u> Choose the <b>one</b> description of the landscape around the wetland that best fits (see p. 84)</p> <ul style="list-style-type: none"> <li>• There are at least 3 other wetlands within 1/2 mile, and the connections between them are relatively undisturbed (light grazing between wetlands OK, as is lake shore with some boating, but connections should NOT be bisected by paved roads, fill, fields, or other development.....points = 5</li> <li>• The wetland is Lake-fringe on a lake with little disturbance and there are 3 other lake-fringe wetlands within 1/2 mile .....points = 5</li> <li>• <b>There are at least 3 other wetlands within 1/2 mile, BUT the connections between them are disturbed.....points = 3</b></li> <li>• The wetland fringe on a lake <b>with</b> disturbance and there are 3 other lake-fringe wetlands within 1/2 mile .....points = 3</li> <li>• There is at least 1 wetland within 1/2 mile .....points = 2</li> <li>• There are no wetlands within 1/2 mile.....points = 0</li> </ul>	3
<p><b>H 2 TOTAL Score</b> – opportunity for providing habitat                      Add the scores from H2.1, H2.2, H2.3, H2.4</p>		8
		TOTAL for H 1 from page 8
<p>◆ <b>Total Score for Habitat Functions</b>                      Add the points for H 1 and H 2; then <b>record the result on p. 1</b></p>		3
		11

Comments:



<p><b>SC4</b></p>	<p><b>Forested Wetlands</b> (see p. 90)                  Does the wetland have at least 1 acre of forest that meet one of these criteria for the Department of Fish and Wildlife's forests as priority habitats? <i>If you answer yes you will still need to rate the wetland based on its function.</i>                  ___ <b>Old-growth forests:</b> (west of Cascade Crest) Stands of at least two three species forming a multi-layered canopy with occasional small openings; with at least 8 trees/acre (20 trees/hectare) that are at least 200 years of age OR have a diameter at breast height (dbh) of 32 inches (81 cm or more).                  NOTE: The criterion for dbh is based on measurements for upland forests. Two-hundred year old trees in wetlands will often have a smaller dbh because their growth rates are often slower. The DFW criterion is and "OR" so old-growth forests do not necessarily have to have trees of this diameter.                  ___ <b>Mature forests:</b> (west of the Cascade Crest) Stands where the largest trees are 80 – 200 years old OR have an average diameters (dbh) exceeding 21 inches (53 cm); crown cover may be less than 100%; decay, decadence, numbers of snags, and quantity of large downed material is generally less than that found in old-growth.                  YES = Category I                      NO = <u>X</u> not a forested wetland with special characteristics</p>	<p><b>Cat. I</b></p>
<p><b>SC5</b></p>	<p><b>Wetlands in Coastal Lagoons</b> (see p. 91)                  Does the wetland meet all of the following criteria of a wetland in a coastal lagoon?                  ___ The wetland lies in a depression adjacent to marine waters that is wholly or partially separated from marine waters by sandbanks, gravel banks, shingle, or, less frequently, rocks.                  ___ The lagoon in which the wetland is located contains surface water that is saline or brackish (&gt; 0.5 ppt) during most of the year in at least a portion of the lagoon (<i>needs to be measured near the bottom.</i>)                  YES = Go to SC 5.1                      NO <u>X</u> not a wetland in a coastal lagoon                  SC 5.1 Does the wetland meet all of the following three conditions?                  ___ The wetland is relatively undisturbed (has no diking, ditching, filling, cultivation, grazing) and has less than 20% cover of invasive plant species (see list of invasive species on p. 74).                  ___ At least 3/4 of the landward edge of the wetland has a 100 ft. buffer of shrub, forest, or un-grazed or un-mowed grassland.                  ___ The wetland is larger than 1/10 acre (4350 square ft.)                  YES = Category I                      NO = Category II</p>	<p><b>Cat. I</b>  <b>Cat. II</b></p>
<p><b>SC6</b></p>	<p><b>Interdunal Wetlands</b> (see p. 93)                  Is the wetland west of the 1889 line (also called the Western Boundary of Upland Ownership or WBUO)?                  YES = Go to SC 6.1                      NO <u>X</u> not an interdunal wetland for rating  <i>If you answer yes you will still need to rate the wetland based on its functions.</i>                  In practical terms that means the following geographic areas:                  • Long Beach Peninsula -- lands west of SR 103                  • Grayland-Westport -- lands west of SR 105                  • Ocean Shores-Copalis – lands west of SR 115 and SR 109                  SC 6.1 Is the wetland one acre or larger, or is it in a mosaic of wetlands that is one acre or larger?                  YES = Category II                      NO = go to SC 6.2                  SC 6.2 Is the wetland between 0.1 and 1 acre, or is it in a mosaic of wetlands that is between 0.1 and 1 acre?                  YES = Category III</p>	<p><b>Cat. II</b>  <b>Cat. III</b></p>
<p>◆</p>	<p><b>Category of wetland based on Special Characteristics</b>                  Choose the "highest" rating if wetland falls into several categories, and record on p. 1.                  If you answered NO for all types enter "Not Applicable" on p. 1</p>	<p><b>NA</b></p>

Comments:

Wetland name or number 26D

**WETLAND RATING FORM – WESTERN WASHINGTON**  
Version 2 – Updated July 2006 to increase accuracy and reproducibility among users  
Updated Oct. 2008 with the new WDFW definitions for priority habitats

Name of wetland (if known): 26D Date of site visit: 03-19-14

Rated by: Colin Worsley Trained by Ecology? Yes X No      Date of training: 11-2005

SEC: 32 TOWNSHIP: 25N RANGE: 06E Is S/T/R in Appendix D? Yes      No X

Map of wetland unit: Figure                      Estimated size ~0.13 acre

**SUMMARY OF RATING**

Category based on FUNCTIONS provided by wetland: I      II      III      **X** IV     

Category I =	Score > 70
Category II =	Score 51 - 69
Category III =	Score 30 – 50
Category IV =	Score < 30

Score for Water Quality Functions	16
Score for Hydrologic Functions	18
Score for Habitat Functions	14
<b>TOTAL Score for Functions</b>	<b>48</b>

Category based on SPECIAL CHARACTERISTICS of Wetland I      II      Does not apply X

**Final Category** (choose the “highest” category from above”) III

**Summary of basic information about the wetland unit.**

Wetland Unit has Special Characteristics		Wetland HGM Class used for Rating	
Estuarine		Depressional	
Natural Heritage Wetland		Riverine	X
Bog		Lake-fringe	(x)
Mature Forest		Slope	
Old Growth Forest		Flats	
Coastal Lagoon		Freshwater Tidal	
Interdunal			
None of the above	X	Check if unit has multiple HGM classes present	X

**Does the wetland being rated meet any of the criteria below?** If you answer YES to any of the questions below you will need to protect the wetland according to the regulations regarding the special characteristics found in the wetland.

Check List for Wetlands that Need Additional Protection (in addition to the protection recommended for its category)	YES	NO
SP1. <i>Has the wetland unit been documented as a habitat for any Federally listed Threatened or Endangered <b>animal or plant</b> species (T/E species)?</i> For the purposes of this rating system, “documented” means the wetland is on the appropriate state or federal database.		X
SP2. <i>Has the wetland unit been documented as habitat for any State listed Threatened or Endangered <b>animal</b> species?</i> For the purposes of this rating system, “documented” means the wetland is on the appropriate state database. Note: Wetlands with State listed plant species are categorized as Category 1 Natural Heritage Wetlands (see p. 19 of data form).		X
SP3. <i>Does the wetland unit contain individuals of Priority species listed by the WDFW for the state?</i>		X
SP4. <i>Does the wetland unit have a local significance in addition to its functions?</i> For example, the wetland has been identified in the Shoreline Master Program, the Critical Areas Ordinance, or in a local management plan as having special significance.		X

To complete the next part of the data sheet you will need to determine the Hydrogeomorphic Class of the wetland being rated.

Exhibit 16  
SSDP2016-00415  
001199

### Classification of Vegetated Wetlands for Western Washington

If the hydrologic criteria listed in each question do not apply to the entire unit being rated, you probably have a unit with multiple HGM classes. In this case, identify which hydrologic criteria in questions 1-7 apply, and go to Question 8.

1. Are the water levels in the entire unit usually controlled by tides (i.e. except during floods)?  
NO – go to 2                      **YES – the wetland class is Tidal Fringe**  
 If yes, is the salinity of the water during periods of annual low flow below 0.5 ppt (parts per thousand)?  
**YES – Freshwater Tidal Fringe**                      **NO – Saltwater Tidal Fringe (Estuarine)**  
*If your wetland can be classified as a Freshwater Tidal Fringe use the forms for Riverine wetlands. If it is a Saltwater Tidal Fringe it is rated as an Estuarine wetland. Wetlands that were call estuarine in the first and second editions of the rating system are called Salt Water Tidal Fringe in the Hydrogeomorphic Classification. Estuarine wetlands were categorized separately in the earlier editions, and this separation is being kept in this revision. To maintain consistency between editions, the term “Estuarine” wetland is kept. Please note, however, that the characteristics that define Category I and II estuarine wetlands have changed (see p. \_\_\_\_).*

---

2. The entire wetland unit is flat and precipitation is only source (>90%) of water to it. Groundwater and surface water runoff are NOT sources of water to the unit.  
NO – go to 3                      **YES – The wetland class is Flats**  
 If your wetland can be classified as a “Flats” wetland, use the form for **Depressional** wetlands.

---

3. Does the entire wetland meet both of the following criteria?  
 \_\_\_\_\_ The vegetated part of the wetland is on the shores of a body of permanent open water (without any vegetation on the surface) where at least 20 acres (8ha) in size;  
 \_\_\_\_\_ At least 30% of the open water area is deeper than 6.6 (2 m)?  
NO – go to 4                      **YES – The wetland class is Lake-fringe (Lacustrine Fringe)**

---

4. Does the entire wetland meet all of the following criteria?  
 \_\_\_\_\_ The wetland is on a slope (*slope can be very gradual*).  
 \_\_\_\_\_ The water flows through the wetland in one direction (unidirectional) and usually comes from seeps. It may flow subsurface, as sheetflow, or in a swale without distinct banks.  
 \_\_\_\_\_ The water leaves the wetland **without being impounded**?  
 NOTE: *Surface water does not pond in these types of wetlands except occasionally in very small and shallow depressions or behind hummocks (depressions are usually <3 ft diameter and less than 1 foot deep).*  
NO – go to 5                      **YES – The wetland class is Slope**

---

5. Does the entire wetland meet all of the following criteria?  
 \_\_\_\_\_ The unit is in a valley or stream channel where it gets inundated by overbank flooding from that stream or river.  
 \_\_\_\_\_ The overbank flooding occurs at least once every two years.  
 NOTE: *The riverine unit can contain depressions that are filled with water when the river is not flooding..*  
NO – go to 6                      **YES – The wetland class is Riverine**

---

6. Is the entire wetland unit in a topographic depression in which water ponds, or is saturated to the surface, at some time of the year. This means that any outlet, if present is higher than the interior of the wetland.  
NO – go to 7                      **YES – The wetland class is Depressional**

---

7. Is the entire wetland located in a very flat area with no obvious depression and no overbank flooding. The unit does not pond surface water more than a few inches. The unit seems to be maintained by high groundwater in the area. The wetland may be ditched, but has no obvious natural outlet.  
No – go to 8                      **YES – The wetland class is Depressional**

---

8. Your wetland unit seems to be difficult to classify and probably contains several different HGM classes. For example, seeps at the base of a slope may grade into a riverine floodplain, or a small stream within a depressional wetland has a zone of flooding along its sides. **GO BACK AND IDENTIFY WHICH OF THE HYDROLOGIC REGIMES DESCRIBED IN QUESTIONS 1-7 APPLY TO DIFFERENT AREAS IN THE UNIT** (make a rough sketch to help you decide). Use the following table to identify the appropriate class to use for the rating system if you have several HGM classes present within your wetland. NOTE: Use this table only if the class that is recommended in the second column represents 10% or more of the total area of the wetland unit being rated. If the area of the class listed in column 2 is less than 10% of the unit, classify the wetland using the class that represents more than 90% of the total area.

HGM Classes within the wetland unit being rated	HGM Class to Use in Rating
Slope + Riverine	Riverine
Slope + Depressional	Depressional
Slope + Lake-fringe	Lake-fringe
Depressional + Riverine along stream within boundary	Depressional
Depressional + Lake-fringe	Depressional
Salt Water Tidal Fringe and any other class of freshwater wetland	Treat as ESTUARINE under wetlands with special characteristics

**Exhibit 16**  
**SSDP2016-00415**  
**001200**

If you are unable still to determine which of the above criteria apply to your wetland, or you have more than 2 HGM classes within a wetland boundary, classify the wetland as **Depressional** for the rating.

<b>R Riverine and Freshwater Tidal Fringe Wetlands</b>		<b>Points</b>
WATER QUALITY FUNCTIONS – Indicators that wetland functions to improve water quality.		(only 1 score per box)
<b>R 1</b>	<b>Does the wetland have the <u>potential</u> to improve water quality?</b> (see p.52)	
	R 1.1 Area of surface depressions within the riverine wetland that can trap sediments during a flooding event: <ul style="list-style-type: none"> <li>• Depressions cover &gt; 3/4 area of wetland ..... points = 8</li> <li>• Depressions cover &gt; 1/2 area of wetland ..... points = 4</li> <li><b>(If depressions &gt; 1/2 of area of unit draw polygons on aerial photo or map)</b></li> <li>• <b>Depressions present but cover &lt; 1/2 area of wetland. .... points = 2</b></li> <li>• No depressions present ..... points = 0</li> </ul>	<b>Figure</b> ___  2
	R 1.2 Characteristics of the vegetation in the unit (areas with >90% cover at person height): <ul style="list-style-type: none"> <li>• Trees or shrubs &gt; 2/3 area of the unit ..... points = 8</li> <li>• <b>Trees or shrubs &gt; 1/3 area of the wetland ..... points = 6</b></li> <li>• Ungrazed, herbaceous plants &gt; 2/3 area of unit ..... points = 6</li> <li>• Ungrazed herbaceous plants &gt; 1/3 area of unit ..... points = 3</li> <li>• Trees, shrubs, and ungrazed herbaceous &lt; 1/3 area of unit ..... points = 0</li> </ul>	<b>Figure</b> ___  6
<b>Aerial photo or map showing polygons of different vegetation types</b>		
Add the points in the boxes above		8
<b>R 2</b>	<b>Does the wetland have the <u>opportunity</u> to improve water quality?</b>	(see p. 53)
	Answer YES if you know or believe there are pollutants in groundwater or surface water coming into the wetland that would otherwise reduce water quality in streams, lakes or groundwater downgradient from the wetland. <i>Note which of the following conditions provide the sources of pollutants. A unit may have pollutants coming from several sources, but any single source would qualify as opportunity.</i> <ul style="list-style-type: none"> <li>___ Grazing in the wetland or within 150 ft</li> <li>___ Untreated stormwater discharges to wetland</li> <li>___ Tilled fields or orchards within 150 ft. of wetland</li> <li>___ A stream or culvert discharges into wetland that drains developed areas, residential areas, farmed fields, roads, or clear-cut logging</li> <li><input checked="" type="checkbox"/> Residential, urban areas, golf courses are within 150 ft. of wetland</li> <li>___ The river or stream linked to the wetland has a contributing basin where human activities have raised levels of sediment, toxic compounds or nutrients in the river water above standards for water quality.</li> <li>___ Other _____</li> </ul>	Multiplier  ___X2___
<input checked="" type="checkbox"/> YES multiplier is 2                      NO multiplier is 1		
<b>◆ TOTAL – Water Quality Functions</b> Multiply the score from R1 by R2; then <i>add score to table on p. 1</i>		16
HYDROLOGIC FUNCTIONS – Indicators that wetland functions to reduce flooding and stream erosion.		
<b>R 3</b>	<b>Does the wetland have the <u>potential</u> to reduce flooding and erosion?</b>	(see p.54)
	R 3.1 Characteristics of the overbank storage the wetland provides: <i>Estimate the average width of the wetland perpendicular to the direction of the flow and the width of the stream or river channel (distance between banks). Calculate the ratio: (average width of unit) / (average width of stream between banks).</i> <ul style="list-style-type: none"> <li>• If the ratio is more than 20 ..... points = 9</li> <li>• If the ratio is between 10 – 20 ..... points = 6</li> <li>• If the ratio is 5- &lt;10 ..... points = 4</li> <li>• <b>If the ratio is 1- &lt;5 ..... points = 2</b></li> <li>• If the ratio is &lt; 1 ..... points = 1</li> </ul>	<b>Figure</b> ___  2
	R 3.2 Characteristics of vegetation that slow down water velocities during floods: <i>Treat large woody debris as “forest or shrub”. Choose the points appropriate for the best description. (polygons need to have &gt;90% cover at person height NOT Cowardin classes):</i> <ul style="list-style-type: none"> <li>• <b>Forest or shrub for &gt; 1/3 area OR herbaceous plants &gt; 2/3 area ..... points = 7</b></li> <li>• Forest or shrub for &gt; 1/10 area OR herbaceous plants &gt; 1/3 area ..... points = 4</li> <li>• Vegetation does not meet above criteria ..... points = 0</li> </ul>	<b>Figure</b> ___  7
<b>Aerial photo or map showing polygons of different vegetation types</b>		
Add the points in the boxes above		9
<b>R 4</b>	<b>Does the wetland have the <u>opportunity</u> to reduce flooding and erosion?</b>	(see p.57)
	Answer YES if the wetland is in a location in the watershed where the flood storage, or reduction in water velocity, it provides helps protect downstream property and aquatic resources from flooding or excessive and/or erosive flows. <i>Note which of the following conditions apply.</i> <ul style="list-style-type: none"> <li><input checked="" type="checkbox"/> There are human structures and activities downstream (roads, buildings, bridges, farms) that can be damaged by flooding.</li> <li><input checked="" type="checkbox"/> There are natural resources downstream (e.g. salmon redds) that can be damaged by flooding</li> <li>___ Other _____</li> </ul> (Answer NO if the major source of water to the wetland is controlled by a reservoir or the wetland is tidal fringe along the sides of a dike)	Multiplier  ___X2___
<input checked="" type="checkbox"/> YES multiplier is 2                      NO multiplier is 1		
<b>◆ TOTAL – Hydrologic Functions</b> Multiply the score from R3 by R4; then <i>add score to table on p. 1</i>		18

Comments:

**Exhibit 16**  
**SSDP2016-00415**  
**001201**







	<p>H 2.3 <u>Near or adjacent to other priority habitats listed by WDFW</u> (see p. 82): (see new and complete descriptions of WDFW priority habitats, and the counties in which they can be found, in the PHS report <a href="http://wdfw.wa.gov/hab/phslist.htm">http://wdfw.wa.gov/hab/phslist.htm</a> )</p> <p>Which of the following priority habitats are within 330 ft. (100m) of the wetland unit?  <i>NOTE: the connections do not have to be relatively undisturbed.</i></p> <p><input type="checkbox"/> <b>Aspen Stands:</b> Pure or mixed stands of aspen greater than 0.4 ha (1 acre).</p> <p><input type="checkbox"/> <b>Biodiversity Areas and Corridors:</b> Areas of habitat that are relatively important to various species of native fish and wildlife (full descriptions in WDFW PHS report p. 152).</p> <p><input type="checkbox"/> <b>Herbaceous Balds:</b> Variable size patches of grass and forbs on shallow soils over bedrock.</p> <p><input type="checkbox"/> <b>Old-growth/Mature forests:</b> (Old-growth west of Cascade crest) Stands of at least 2 tree species, forming a multi-layered canopy with occasional small openings; with at least 20 trees/ha (8 trees/acre) &gt; 81 cm (32 in) dbh or &gt; 200 years of age. (Mature forests) Stands with average diameters exceeding 53 cm (21 in) dbh; crown cover may be less than 100%; decay, decadence, numbers of snags, and quantity of large downed material is generally less than that found in old-growth; 80 - 200 years old west of the Cascade crest.</p> <p><input type="checkbox"/> <b>Oregon white Oak:</b> Woodlands Stands of pure oak or oak/conifer associations where canopy coverage of the oak component is important (full descriptions in WDFW PHS report p. 158).</p> <p><input checked="" type="checkbox"/> <b>Riparian:</b> The area adjacent to aquatic systems with flowing water that contains elements of both aquatic and terrestrial ecosystems which mutually influence each other.</p> <p><input type="checkbox"/> <b>Westside Prairies:</b> Herbaceous, non-forested plant communities that can either take the form of a dry prairie or a wet prairie (full descriptions in WDFW PHS report p. 161).</p> <p><input checked="" type="checkbox"/> <b>Instream:</b> The combination of physical, biological, and chemical processes and conditions that interact to provide functional life history requirements for instream fish and wildlife resources.</p> <p><input type="checkbox"/> <b>Nearshore:</b> Relatively undisturbed nearshore habitats. These include Coastal Nearshore, Open Coast Nearshore, and Puget Sound Nearshore. (full descriptions of habitats and the definition of relatively undisturbed are in WDFW report: pp. 167-169 and glossary in Appendix A).</p> <p><input type="checkbox"/> <b>Caves:</b> A naturally occurring cavity, recess, void, or system of interconnected passages under the earth in soils, rock, ice, or other geological formations and is large enough to contain a human.</p> <p><input type="checkbox"/> <b>Cliffs:</b> Greater than 7.6 m (25 ft) high and occurring below 5000 ft.</p> <p><input type="checkbox"/> <b>Talus:</b> Homogenous areas of rock rubble ranging in average size 0.15 - 2.0 m (0.5 - 6.5 ft), composed of basalt, andesite, and/or sedimentary rock, including riprap slides and mine tailings. May be associated with cliffs.</p> <p><input type="checkbox"/> <b>Snags and Logs:</b> Trees are considered snags if they are dead or dying and exhibit sufficient decay characteristics to enable cavity excavation/use by wildlife. Priority snags have a diameter at breast height of &gt; 51 cm (20 in) in western Washington and are &gt; 2 m (6.5 ft) in height. Priority logs are &gt; 30 cm (12 in) in diameter at the largest end, and &gt; 6 m (20 ft) long.</p> <p>If wetland has <b>3 or more</b> priority habitats = <b>4 points</b>  <b>If wetland has 2</b> priority habitats = <b>3 points</b>                  If wetland has <b>1</b> priority habitat = <b>1 point</b>                      No habitats = 0 points</p> <p>Note: All vegetated wetlands are by definition a priority habitat but are not included in this list. Nearby wetlands are addressed in question H 2.4)</p>	3
	<p>H 2.4 <u>Wetland Landscape:</u> Choose the <b>one</b> description of the landscape around the wetland that best fits (see p. 84)</p> <ul style="list-style-type: none"> <li>• There are at least 3 other wetlands within 1/2 mile, and the connections between them are relatively undisturbed (light grazing between wetlands OK, as is lake shore with some boating, but connections should NOT be bisected by paved roads, fill, fields, or other development.....points = 5</li> <li>• The wetland is Lake-fringe on a lake with little disturbance and there are 3 other lake-fringe wetlands within 1/2 mile .....points = 5</li> <li>• <b>There are at least 3 other wetlands within 1/2 mile, BUT the connections between them are disturbed.....points = 3</b></li> <li>• The wetland fringe on a lake <b>with</b> disturbance and there are 3 other lake-fringe wetlands within 1/2 mile .....points = 3</li> <li>• There is at least 1 wetland within 1/2 mile .....points = 2</li> <li>• There are no wetlands within 1/2 mile.....points = 0</li> </ul>	3
<p><b>H 2 TOTAL Score</b> – opportunity for providing habitat                      <i>Add the scores from H2.1, H2.2, H2.3, H2.4</i></p>		8
<p style="text-align: right;"><i>TOTAL for H 1 from page 8</i></p>		6
◆	<p><b>Total Score for Habitat Functions</b>                      Add the points for H 1 and H 2; then <b>record the result on p. 1</b></p>	14

Comments:



<p><b>SC4</b></p>	<p><b>Forested Wetlands</b> (see p. 90)                  Does the wetland have at least 1 acre of forest that meet one of these criteria for the Department of Fish and Wildlife's forests as priority habitats? <i>If you answer yes you will still need to rate the wetland based on its function.</i></p> <p>___ <b>Old-growth forests:</b> (west of Cascade Crest) Stands of at least two three species forming a multi-layered canopy with occasional small openings; with at least 8 trees/acre (20 trees/hectare) that are at least 200 years of age OR have a diameter at breast height (dbh) of 32 inches (81 cm or more).</p> <p>NOTE: The criterion for dbh is based on measurements for upland forests. Two-hundred year old trees in wetlands will often have a smaller dbh because their growth rates are often slower. The DFW criterion is and "OR" so old-growth forests do not necessarily have to have trees of this diameter.</p> <p>___ <b>Mature forests:</b> (west of the Cascade Crest) Stands where the largest trees are 80 – 200 years old OR have an average diameters (dbh) exceeding 21 inches (53 cm); crown cover may be less than 100%; decay, decadence, numbers of snags, and quantity of large downed material is generally less than that found in old-growth.</p> <p>YES = Category I                      NO = <u> X </u> not a forested wetland with special characteristics</p>	<p><b>Cat. I</b></p>
<p><b>SC5</b></p>	<p><b>Wetlands in Coastal Lagoons</b> (see p. 91)                  Does the wetland meet all of the following criteria of a wetland in a coastal lagoon?</p> <p>___ The wetland lies in a depression adjacent to marine waters that is wholly or partially separated from marine waters by sandbanks, gravel banks, shingle, or, less frequently, rocks.</p> <p>___ The lagoon in which the wetland is located contains surface water that is saline or brackish (&gt; 0.5 ppt) during most of the year in at least a portion of the lagoon (<i>needs to be measured near the bottom.</i>)</p> <p>YES = Go to SC 5.1                      NO <u> X </u> not a wetland in a coastal lagoon</p> <p>SC 5.1 Does the wetland meet all of the following three conditions?</p> <p>___ The wetland is relatively undisturbed (has no diking, ditching, filling, cultivation, grazing) and has less than 20% cover of invasive plant species (see list of invasive species on p. 74).</p> <p>___ At least 3/4 of the landward edge of the wetland has a 100 ft. buffer of shrub, forest, or un-grazed or un-mowed grassland.</p> <p>___ The wetland is larger than 1/10 acre (4350 square ft.)</p> <p>YES = Category I                      NO = Category II</p>	<p><b>Cat. I</b></p> <p><b>Cat. II</b></p>
<p><b>SC6</b></p>	<p><b>Interdunal Wetlands</b> (see p. 93)                  Is the wetland west of the 1889 line (also called the Western Boundary of Upland Ownership or WBUO)?</p> <p>YES = Go to SC 6.1                      NO <u> X </u> not an interdunal wetland for rating</p> <p><b><i>If you answer yes you will still need to rate the wetland based on its functions.</i></b></p> <p>In practical terms that means the following geographic areas:</p> <ul style="list-style-type: none"> <li>• Long Beach Peninsula -- lands west of SR 103</li> <li>• Grayland-Westport -- lands west of SR 105</li> <li>• Ocean Shores-Copalis – lands west of SR 115 and SR 109</li> </ul> <p>SC 6.1 Is the wetland one acre or larger, or is it in a mosaic of wetlands that is one acre or larger?</p> <p>YES = Category II                      NO = go to SC 6.2</p> <p>SC 6.2 Is the wetland between 0.1 and 1 acre, or is it in a mosaic of wetlands that is between 0.1 and 1 acre?</p> <p>YES = Category III</p>	<p><b>Cat. II</b></p> <p><b>Cat. III</b></p>
<p>◆</p>	<p><b>Category of wetland based on Special Characteristics</b>                  Choose the "highest" rating if wetland falls into several categories, and record on p. 1.                  If you answered NO for all types enter "Not Applicable" on p. 1</p>	<p><b>NA</b></p>

**Comments:**

Wetland name or number 28A

**WETLAND RATING FORM – WESTERN WASHINGTON**  
Version 2 – Updated July 2006 to increase accuracy and reproducibility among users  
Updated Oct. 2008 with the new WDFW definitions for priority habitats

Name of wetland (if known): 28A Date of site visit: 09-27-13

Rated by: Colin Worsley / Matt Maynard Trained by Ecology? Yes X No      Date of training: 11-2005 / 04-2006

SEC: 29 TOWNSHIP: 25N RANGE: 06E Is S/T/R in Appendix D? Yes      No X

Map of wetland unit: Figure      Estimated size 0.09 acre

**SUMMARY OF RATING**

Category based on FUNCTIONS provided by wetland: I      II      III      IV X

Category I =	Score > 70
Category II =	Score 51 - 69
Category III =	Score 30 – 50
Category IV =	Score < 30

Score for Water Quality Functions	8
Score for Hydrologic Functions	6
Score for Habitat Functions	13
<b>TOTAL Score for Functions</b>	<b>27</b>

Category based on SPECIAL CHARACTERISTICS of Wetland I      II      Does not apply X

**Final Category** (choose the “highest” category from above”) IV

**Summary of basic information about the wetland unit.**

Wetland Unit has Special Characteristics		Wetland HGM Class used for Rating	
Estuarine		Depressional	X
Natural Heritage Wetland		Riverine	(x)
Bog		Lake-fringe	
Mature Forest		Slope	
Old Growth Forest		Flats	
Coastal Lagoon		Freshwater Tidal	
Interdunal			
None of the above	X	Check if unit has multiple HGM classes present	X

**Does the wetland being rated meet any of the criteria below?** If you answer YES to any of the questions below you will need to protect the wetland according to the regulations regarding the special characteristics found in the wetland.

Check List for Wetlands that Need Additional Protection (in addition to the protection recommended for its category)	YES	NO
SP1. <i>Has the wetland unit been documented as a habitat for any Federally listed Threatened or Endangered <b>animal or plant</b> species (T/E species)?</i> For the purposes of this rating system, “documented” means the wetland is on the appropriate state or federal database.		X
SP2. <i>Has the wetland unit been documented as habitat for any State listed Threatened or Endangered <b>animal</b> species?</i> For the purposes of this rating system, “documented” means the wetland is on the appropriate state database. Note: Wetlands with State listed plant species are categorized as Category 1 Natural Heritage Wetlands (see p. 19 of data form).		X
SP3. <i>Does the wetland unit contain individuals of Priority species listed by the WDFW for the state?</i>		X
SP4. <i>Does the wetland unit have a local significance in addition to its functions?</i> For example, the wetland has been identified in the Shoreline Master Program, the Critical Areas Ordinance, or in a local management plan as having special significance.		X

To complete the next part of the data sheet you will need to determine the Hydrogeomorphic Class of the wetland being rated.

Exhibit 16  
SSDP2016-00415  
001207

### Classification of Vegetated Wetlands for Western Washington

If the hydrologic criteria listed in each question do not apply to the entire unit being rated, you probably have a unit with multiple HGM classes. In this case, identify which hydrologic criteria in questions 1-7 apply, and go to Question 8.

1. Are the water levels in the entire unit usually controlled by tides (i.e. except during floods)?

**NO – go to 2**

**YES – the wetland class is Tidal Fringe**

If yes, is the salinity of the water during periods of annual low flow below 0.5 ppt (parts per thousand)?

**YES – Freshwater Tidal Fringe**

**NO – Saltwater Tidal Fringe (Estuarine)**

*If your wetland can be classified as a Freshwater Tidal Fringe use the forms for **Riverine** wetlands. If it is a Saltwater Tidal Fringe it is rated as an **Estuarine** wetland. Wetlands that were call estuarine in the first and second editions of the rating system are called Salt Water Tidal Fringe in the Hydrogeomorphic Classification. Estuarine wetlands were categorized separately in the earlier editions, and this separation is being kept in this revision. To maintain consistency between editions, the term “Estuarine” wetland is kept. Please note, however, that the characteristics that define Category I and II estuarine wetlands have changed (see p. \_\_\_\_).*

2. The entire wetland unit is flat and precipitation is only source (>90%) of water to it. Groundwater and surface water runoff are NOT sources of water to the unit.

**NO – go to 3**

**YES – The wetland class is Flats**

If your wetland can be classified as a “Flats” wetland, use the form for **Depressional** wetlands.

3. Does the entire wetland meet both of the following criteria?

\_\_\_\_\_ The vegetated part of the wetland is on the shores of a body of permanent open water (without any vegetation on the surface) where at least 20 acres (8ha) in size;

\_\_\_\_\_ At least 30% of the open water area is deeper than 6.6 (2 m)?

**NO – go to 4**

**YES – The wetland class is Lake-fringe (Lacustrine Fringe)**

4. Does the entire wetland meet all of the following criteria?

\_\_\_\_\_ The wetland is on a slope (*slope can be very gradual*).

\_\_\_\_\_ The water flows through the wetland in one direction (unidirectional) and usually comes from seeps. It may flow subsurface, as sheetflow, or in a swale without distinct banks.

\_\_\_\_\_ The water leaves the wetland **without being impounded**?

*NOTE: Surface water does not pond in these types of wetlands except occasionally in very small and shallow depressions or behind hummocks (depressions are usually <3 ft diameter and less than 1 foot deep).*

**NO – go to 5**

**YES – The wetland class is Slope**

5. Does the entire wetland meet all of the following criteria?

\_\_\_\_\_ The unit is in a valley or stream channel where it gets inundated by overbank flooding from that stream or river.

\_\_\_\_\_ The overbank flooding occurs at least once every two years.

*NOTE: The riverine unit can contain depressions that are filled with water when the river is not flooding..*

**NO – go to 6**

**YES – The wetland class is Riverine**

6. Is the entire wetland unit in a topographic depression in which water ponds, or is saturated to the surface, at some time of the year. This means that any outlet, if present is higher than the interior of the wetland.

**NO – go to 7**

**YES – The wetland class is Depressional**

7. Is the entire wetland located in a very flat area with no obvious depression and no overbank flooding. The unit does not pond surface water more than a few inches. The unit seems to be maintained by high groundwater in the area. The wetland may be ditched, but has no obvious natural outlet.

**No – go to 8**

**YES – The wetland class is Depressional**

8. Your wetland unit seems to be difficult to classify and probably contains several different HGM classes. For example, seeps at the base of a slope may grade into a riverine floodplain, or a small stream within a depressional wetland has a zone of flooding along its sides. **GO BACK AND IDENTIFY WHICH OF THE HYDROLOGIC REGIMES DESCRIBED IN QUESTIONS 1-7 APPLY TO DIFFERENT AREAS IN THE UNIT** (make a rough sketch to help you decide). Use the following table to identify the appropriate class to use for the rating system if you have several HGM classes present within your wetland. **NOTE:** Use this table only if the class that is recommended in the second column represents 10% or more of the total area of the wetland unit being rated. If the area of the class listed in column 2 is less than 10% of the unit, classify the wetland using the class that represents more than 90% of the total area.

<i>HGM Classes within the wetland unit being rated</i>	<i>HGM Class to Use in Rating</i>
Slope + Riverine	Riverine
Slope + Depressional	Depressional
Slope + Lake-fringe	Lake-fringe
Depressional + Riverine along stream within boundary	Depressional
Depressional + Lake-fringe	Depressional
Salt Water Tidal Fringe and any other class of freshwater wetland	Treat as ESTUARINE under wetlands with special characteristics

**Exhibit 16**

**SSDP2016-00415**

**001208**

If you are unable still to determine which of the above criteria apply to your wetland, or you have more than 2 HGM classes within a wetland boundary, classify the wetland as **Depressional** for the rating.



<b>D 4</b>	<p><b>Does the wetland have the <u>opportunity</u> to reduce flooding and erosion?</b></p> <p>Answer YES if the unit is in a location in the watershed where the flood storage, or reduction in water velocity, it provides helps protect downstream property and aquatic resources from flooding or excessive and/or erosive flows. Answer NO if the water coming into the wetland is controlled by a structure such as flood gate, tide gate, flap valve, reservoir etc. OR you estimate that more than 90% of the water in the wetland is from groundwater in areas where damaging groundwater flooding does not occur. <i>Note which of the following indicators of opportunity apply.</i></p> <p><input type="checkbox"/> Wetland is in a headwater of a river or stream that has flooding problems.</p> <p><input checked="" type="checkbox"/> Wetland drains to a river or stream that has flooding problems</p> <p><input type="checkbox"/> Wetland has no outlet and impounds surface runoff water that might otherwise flow into a river or stream that has flooding problems</p> <p><input type="checkbox"/> Other _____</p> <p><b>YES multiplier is 2</b>                      NO multiplier is 1</p>	<p>(see p. 49)</p> <p>Multiplier</p> <p><u>X2</u></p>
◆	<p><b>TOTAL – Hydrologic Functions</b>                      Multiply the score from D3 by D4; then <i>add score to table on p. 1</i></p>	<p><b>6</b></p>

Comments:







<p><i>These questions apply to wetlands of all HGM classes.</i></p> <p>HABITAT FUNCTIONS – Indicators that wetland functions to provide important habitat.</p>		<p><b>Points</b> (only 1 score per box)</p>
<b>H 1</b>	<b>Does the wetland have the <u>potential</u> to provide habitat for many species?</b>	
H 1.1	<p><u>Vegetation structure</u> (see P. 72): Check the types of vegetation classes present (as defined by Cowardin) – Size threshold for each class is 1/4 acre or more than 10% of the area if unit is smaller than 2.5 acres.</p> <p><input type="checkbox"/> Aquatic Bed <input type="checkbox"/> Emergent plants <input type="checkbox"/> Scrub/shrub (areas where shrubs have &gt; 30% cover) <input checked="" type="checkbox"/> Forested (areas where trees have &gt; 30% cover) If the unit has a forested class check if: <input checked="" type="checkbox"/> The forested class has 3 out of 5 strata (canopy, sub-canopy, shrubs, herbaceous, moss/ground-cover) that each cover 20% within the forested polygon. Add the number of vegetation types that qualify. If you have:</p> <p style="text-align: right;"> <b>Map of Cowardin vegetation classes</b>                      4 structures or more..... points = 4                      3 structures..... points = 2                      2 structures..... points = 1                      1 structure..... points = 0                 </p>	<p><b>Figure</b> ____</p> <p style="text-align: right;">1</p>
H 1.2	<p><u>Hydroperiods</u> (see p.73): Check the types of water regimes (hydroperiods) present within the wetland. The water regime has to cover more than 10% of the wetland or 1/4 acre to count (see text for descriptions of hydroperiods).</p> <p><input checked="" type="checkbox"/> Permanently flooded or inundated <input type="checkbox"/> Seasonally flooded or inundated <input type="checkbox"/> Occasionally flooded or inundated <input checked="" type="checkbox"/> Saturated only <input checked="" type="checkbox"/> Permanently flowing stream or river in, or adjacent to, the wetland <input type="checkbox"/> Seasonally flowing stream in, or adjacent to, the wetland <input type="checkbox"/> <b>Lake-fringe wetland..... = 2 points</b> <input type="checkbox"/> <b>Freshwater tidal wetland..... = 2 points</b></p> <p style="text-align: right;"> <b>Map of hydroperiods</b>                      4 or more types present points = 3                      3 or more types present..... points = 2                      2 types present..... points = 1                      1 type present..... points = 0                 </p>	<p><b>Figure</b> ____</p> <p style="text-align: right;">2</p>
H 1.3	<p><u>Richness of Plant Species</u> (see p. 75): Count the number of plant species in the wetland that cover at least 10 ft<sup>2</sup> (different patches of the same species can be combined to meet the size threshold) You do not have to name the species. Do not include Eurasian Milfoil, reed canarygrass, purple loosestrife, Canadian Thistle. If you counted: &gt; 19 species ..... points = 2 5 – 19 species..... points = 1 &lt; 5 species ..... points = 0</p> <p>List species below if you want to:</p> <p>_____</p> <p>_____</p> <p>_____</p>	<p style="text-align: right;">1</p>
H 1.4	<p><u>Interspersion of Habitats</u> (see p. 76): Decided from the diagrams below whether interspersion between Cowardin vegetation (described in H1.1), or the classes and unvegetated areas (can include open water or mudflats) is high, medium, low, or none.</p> <div style="display: flex; justify-content: space-around;"> <div style="text-align: center;">  <p>None = 0 points</p> </div> <div style="text-align: center;">  <p>Low = 1 point</p> </div> <div style="text-align: center;">  <p>Moderate = 2 points</p> </div> <div style="text-align: center;">  </div> </div> <div style="display: flex; justify-content: space-around; margin-top: 20px;"> <div style="text-align: center;">  </div> <div style="text-align: center;">  <p>High = 3 points</p> </div> <div style="text-align: center;">  <p>[riparian braided channels]</p> </div> </div> <p style="text-align: right;"> <b>Note:</b> If you have 4 or more classes or 3 vegetation classes and open water, the rating is always “high”.   <b>Use map of Cowardin classes.</b> </p>	<p><b>Figure</b> ____</p> <p style="text-align: right;">1</p>
H 1.5	<p><u>Special Habitat Features</u> (see p. 77): Check the habitat features that are present in the wetland. The number of checks is the number of points you put into the next column.</p> <p><input type="checkbox"/> Large, downed, woody debris within the wetland (&gt; 4 in. diameter and 6 ft. long) <input type="checkbox"/> Standing snags (diameter at the bottom &gt; 4 inches) in the wetland <input type="checkbox"/> Undercut banks are present for at least 6.6 ft. (2m) and/or overhanging vegetation extends at least 3.3 ft. (1m) over a stream (or ditch) in, or contiguous with the unit, for at least 33 ft. (10m) <input type="checkbox"/> Stable steep banks of fine material that might be used by beaver or muskrat for denning (&gt; 30 degree slope) OR signs of recent beaver activity are present (cut shrubs or trees that have not yet turned grey/brown) <input type="checkbox"/> At least 1/4 acre of thin-stemmed persistent vegetation or woody branches are present in areas that are permanently or seasonally inundated (structures for egg-laying by amphibians) <input type="checkbox"/> Invasive plants cover less than 25% of the wetland area in each stratum of plants</p> <p><i>NOTE: The 20% stated in early printings of the manual on page 78 is an error.</i></p>	<p style="text-align: right;">0</p>
<p><b>H 1 TOTAL Score</b> – potential for providing habitat</p>		<p style="text-align: right;">5</p>

Exhibit 16  
SSDP2016-00415  
00211

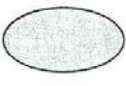

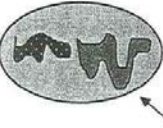

	<p>H 2.3 <u>Near or adjacent to other priority habitats listed by WDFW</u> (see p. 82): (see new and complete descriptions of WDFW priority habitats, and the counties in which they can be found, in the PHS report <a href="http://wdfw.wa.gov/hab/phslist.htm">http://wdfw.wa.gov/hab/phslist.htm</a> )</p> <p>Which of the following priority habitats are within 330 ft. (100m) of the wetland unit?  <i>NOTE: the connections do not have to be relatively undisturbed.</i></p> <p><input type="checkbox"/> <b>Aspen Stands:</b> Pure or mixed stands of aspen greater than 0.4 ha (1 acre).</p> <p><input type="checkbox"/> <b>Biodiversity Areas and Corridors:</b> Areas of habitat that are relatively important to various species of native fish and wildlife (full descriptions in WDFW PHS report p. 152).</p> <p><input type="checkbox"/> <b>Herbaceous Balds:</b> Variable size patches of grass and forbs on shallow soils over bedrock.</p> <p><input type="checkbox"/> <b>Old-growth/Mature forests:</b> (Old-growth west of Cascade crest) Stands of at least 2 tree species, forming a multi-layered canopy with occasional small openings; with at least 20 trees/ha (8 trees/acre) &gt; 81 cm (32 in) dbh or &gt; 200 years of age. (Mature forests) Stands with average diameters exceeding 53 cm (21 in) dbh; crown cover may be less than 100%; decay, decadence, numbers of snags, and quantity of large downed material is generally less than that found in old-growth; 80 - 200 years old west of the Cascade crest.</p> <p><input type="checkbox"/> <b>Oregon white Oak:</b> Woodlands Stands of pure oak or oak/conifer associations where canopy coverage of the oak component is important (full descriptions in WDFW PHS report p. 158).</p> <p><input checked="" type="checkbox"/> <b>Riparian:</b> The area adjacent to aquatic systems with flowing water that contains elements of both aquatic and terrestrial ecosystems which mutually influence each other.</p> <p><input type="checkbox"/> <b>Westside Prairies:</b> Herbaceous, non-forested plant communities that can either take the form of a dry prairie or a wet prairie (full descriptions in WDFW PHS report p. 161).</p> <p><input checked="" type="checkbox"/> <b>Instream:</b> The combination of physical, biological, and chemical processes and conditions that interact to provide functional life history requirements for instream fish and wildlife resources.</p> <p><input type="checkbox"/> <b>Nearshore:</b> Relatively undisturbed nearshore habitats. These include Coastal Nearshore, Open Coast Nearshore, and Puget Sound Nearshore. (full descriptions of habitats and the definition of relatively undisturbed are in WDFW report: pp. 167-169 and glossary in Appendix A).</p> <p><input type="checkbox"/> <b>Caves:</b> A naturally occurring cavity, recess, void, or system of interconnected passages under the earth in soils, rock, ice, or other geological formations and is large enough to contain a human.</p> <p><input type="checkbox"/> <b>Cliffs:</b> Greater than 7.6 m (25 ft) high and occurring below 5000 ft.</p> <p><input type="checkbox"/> <b>Talus:</b> Homogenous areas of rock rubble ranging in average size 0.15 - 2.0 m (0.5 - 6.5 ft), composed of basalt, andesite, and/or sedimentary rock, including riprap slides and mine tailings. May be associated with cliffs.</p> <p><input type="checkbox"/> <b>Snags and Logs:</b> Trees are considered snags if they are dead or dying and exhibit sufficient decay characteristics to enable cavity excavation/use by wildlife. Priority snags have a diameter at breast height of &gt; 51 cm (20 in) in western Washington and are &gt; 2 m (6.5 ft) in height. Priority logs are &gt; 30 cm (12 in) in diameter at the largest end, and &gt; 6 m (20 ft) long.</p> <p>If wetland has <b>3 or more</b> priority habitats = <b>4 points</b>  <b>If wetland has 2</b> priority habitats = <b>3 points</b>                  If wetland has <b>1</b> priority habitat = <b>1 point</b>                      No habitats = 0 points</p> <p>Note: All vegetated wetlands are by definition a priority habitat but are not included in this list. Nearby wetlands are addressed in question H 2.4)</p>	3
	<p>H 2.4 <u>Wetland Landscape:</u> Choose the <b>one</b> description of the landscape around the wetland that best fits (see p. 84)</p> <ul style="list-style-type: none"> <li>• There are at least 3 other wetlands within 1/2 mile, and the connections between them are relatively undisturbed (light grazing between wetlands OK, as is lake shore with some boating, but connections should NOT be bisected by paved roads, fill, fields, or other development.....points = 5</li> <li>• The wetland is Lake-fringe on a lake with little disturbance and there are 3 other lake-fringe wetlands within 1/2 mile .....points = 5</li> <li>• <b>There are at least 3 other wetlands within 1/2 mile, BUT the connections between them are disturbed.....points = 3</b></li> <li>• The wetland fringe on a lake <b>with</b> disturbance and there are 3 other lake-fringe wetlands within 1/2 mile .....points = 3</li> <li>• There is at least 1 wetland within 1/2 mile .....points = 2</li> <li>• There are no wetlands within 1/2 mile.....points = 0</li> </ul>	3
<p><b>H 2 TOTAL Score</b> – opportunity for providing habitat      <i>Add the scores from H2.1, H2.2, H2.3, H2.4</i></p>		8
<p><i>TOTAL for H 1 from page 8</i></p>		5
◆	<p><b>Total Score for Habitat Functions</b>                      Add the points for H 1 and H 2; then <b>record the result on p. 1</b></p>	13

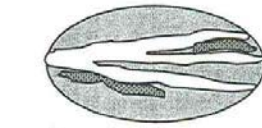
Comments:



<p><b>SC4</b></p>	<p><b>Forested Wetlands</b> (see p. 90)                  Does the wetland have at least 1 acre of forest that meet one of these criteria for the Department of Fish and Wildlife's forests as priority habitats? <i>If you answer yes you will still need to rate the wetland based on its function.</i>                  ___ <b>Old-growth forests:</b> (west of Cascade Crest) Stands of at least two three species forming a multi-layered canopy with occasional small openings; with at least 8 trees/acre (20 trees/hectare) that are at least 200 years of age OR have a diameter at breast height (dbh) of 32 inches (81 cm or more).                  NOTE: The criterion for dbh is based on measurements for upland forests. Two-hundred year old trees in wetlands will often have a smaller dbh because their growth rates are often slower. The DFW criterion is and "OR" so old-growth forests do not necessarily have to have trees of this diameter.                  ___ <b>Mature forests:</b> (west of the Cascade Crest) Stands where the largest trees are 80 – 200 years old OR have an average diameters (dbh) exceeding 21 inches (53 cm); crown cover may be less than 100%; decay, decadence, numbers of snags, and quantity of large downed material is generally less than that found in old-growth.                  YES = Category I                      NO = <u>X</u> not a forested wetland with special characteristics</p>	<p><b>Cat. I</b></p>
<p><b>SC5</b></p>	<p><b>Wetlands in Coastal Lagoons</b> (see p. 91)                  Does the wetland meet all of the following criteria of a wetland in a coastal lagoon?                  ___ The wetland lies in a depression adjacent to marine waters that is wholly or partially separated from marine waters by sandbanks, gravel banks, shingle, or, less frequently, rocks.                  ___ The lagoon in which the wetland is located contains surface water that is saline or brackish (&gt; 0.5 ppt) during most of the year in at least a portion of the lagoon (<i>needs to be measured near the bottom.</i>)                  YES = Go to SC 5.1                      NO <u>X</u> not a wetland in a coastal lagoon                  SC 5.1 Does the wetland meet all of the following three conditions?                  ___ The wetland is relatively undisturbed (has no diking, ditching, filling, cultivation, grazing) and has less than 20% cover of invasive plant species (see list of invasive species on p. 74).                  ___ At least 3/4 of the landward edge of the wetland has a 100 ft. buffer of shrub, forest, or un-grazed or un-mowed grassland.                  ___ The wetland is larger than 1/10 acre (4350 square ft.)                  YES = Category I                      NO = Category II</p>	<p><b>Cat. I</b>  <b>Cat. II</b></p>
<p><b>SC6</b></p>	<p><b>Interdunal Wetlands</b> (see p. 93)                  Is the wetland west of the 1889 line (also called the Western Boundary of Upland Ownership or WBUO)?                  YES = Go to SC 6.1                      NO <u>X</u> not an interdunal wetland for rating  <i>If you answer yes you will still need to rate the wetland based on its functions.</i>                  In practical terms that means the following geographic areas:                  • Long Beach Peninsula -- lands west of SR 103                  • Grayland-Westport -- lands west of SR 105                  • Ocean Shores-Copalis – lands west of SR 115 and SR 109                  SC 6.1 Is the wetland one acre or larger, or is it in a mosaic of wetlands that is one acre or larger?                  YES = Category II                      NO = go to SC 6.2                  SC 6.2 Is the wetland between 0.1 and 1 acre, or is it in a mosaic of wetlands that is between 0.1 and 1 acre?                  YES = Category III</p>	<p><b>Cat. II</b>  <b>Cat. III</b></p>
<p>◆</p>	<p><b>Category of wetland based on Special Characteristics</b>                  Choose the "highest" rating if wetland falls into several categories, and record on p. 1.                  If you answered NO for all types enter "Not Applicable" on p. 1</p>	<p><b>NA</b></p>

**Comments:**

Wetland name or number 28B

**WETLAND RATING FORM – WESTERN WASHINGTON**  
Version 2 – Updated July 2006 to increase accuracy and reproducibility among users  
Updated Oct. 2008 with the new WDFW definitions for priority habitats

Name of wetland (if known): 28B Date of site visit: 09-27-13

Rated by: Colin Worsley / Matt Maynard Trained by Ecology? Yes X No      Date of training: 11-2005 / 04-2006

SEC: 32 TOWNSHIP: 25N RANGE: 06E Is S/T/R in Appendix D? Yes      No X

Map of wetland unit: Figure      Estimated size 0.03 acre

**SUMMARY OF RATING**

Category based on FUNCTIONS provided by wetland: I      II      III      IV X

Category I =	Score > 70
Category II =	Score 51 - 69
Category III =	Score 30 – 50
Category IV =	Score < 30

Score for Water Quality Functions	12
Score for Hydrologic Functions	3
Score for Habitat Functions	6
<b>TOTAL Score for Functions</b>	<b>21</b>

Category based on SPECIAL CHARACTERISTICS of Wetland I      II      Does not apply X

**Final Category** (choose the “highest” category from above”) IV

**Summary of basic information about the wetland unit.**

Wetland Unit has Special Characteristics		Wetland HGM Class used for Rating	
Estuarine		Depressional	X
Natural Heritage Wetland		Riverine	
Bog		Lake-fringe	
Mature Forest		Slope	(x)
Old Growth Forest		Flats	
Coastal Lagoon		Freshwater Tidal	
Interdunal			
None of the above	X	Check if unit has multiple HGM classes present	X

**Does the wetland being rated meet any of the criteria below?** If you answer YES to any of the questions below you will need to protect the wetland according to the regulations regarding the special characteristics found in the wetland.

Check List for Wetlands that Need Additional Protection (in addition to the protection recommended for its category)	YES	NO
SP1. <i>Has the wetland unit been documented as a habitat for any Federally listed Threatened or Endangered <b>animal or plant</b> species (T/E species)?</i> For the purposes of this rating system, “documented” means the wetland is on the appropriate state or federal database.		X
SP2. <i>Has the wetland unit been documented as habitat for any State listed Threatened or Endangered <b>animal</b> species?</i> For the purposes of this rating system, “documented” means the wetland is on the appropriate state database. Note: Wetlands with State listed plant species are categorized as Category 1 Natural Heritage Wetlands (see p. 19 of data form).		X
SP3. <i>Does the wetland unit contain individuals of Priority species listed by the WDFW for the state?</i>		X
SP4. <i>Does the wetland unit have a local significance in addition to its functions?</i> For example, the wetland has been identified in the Shoreline Master Program, the Critical Areas Ordinance, or in a local management plan as having special significance.		X

To complete the next part of the data sheet you will need to determine the Hydrogeomorphic Class of the wetland being rated.

Exhibit 16  
SSDP2016-00415  
001216

### Classification of Vegetated Wetlands for Western Washington

If the hydrologic criteria listed in each question do not apply to the entire unit being rated, you probably have a unit with multiple HGM classes. In this case, identify which hydrologic criteria in questions 1-7 apply, and go to Question 8.

1. Are the water levels in the entire unit usually controlled by tides (i.e. except during floods)?

**NO – go to 2**

**YES – the wetland class is Tidal Fringe**

If yes, is the salinity of the water during periods of annual low flow below 0.5 ppt (parts per thousand)?

**YES – Freshwater Tidal Fringe**

**NO – Saltwater Tidal Fringe (Estuarine)**

*If your wetland can be classified as a Freshwater Tidal Fringe use the forms for Riverine wetlands. If it is a Saltwater Tidal Fringe it is rated as an Estuarine wetland. Wetlands that were call estuarine in the first and second editions of the rating system are called Salt Water Tidal Fringe in the Hydrogeomorphic Classification. Estuarine wetlands were categorized separately in the earlier editions, and this separation is being kept in this revision. To maintain consistency between editions, the term “Estuarine” wetland is kept. Please note, however, that the characteristics that define Category I and II estuarine wetlands have changed (see p. \_\_\_\_\_).*

2. The entire wetland unit is flat and precipitation is only source (>90%) of water to it. Groundwater and surface water runoff are NOT sources of water to the unit.

**NO – go to 3**

**YES – The wetland class is Flats**

If your wetland can be classified as a “Flats” wetland, use the form for **Depressional** wetlands.

3. Does the entire wetland meet both of the following criteria?

\_\_\_\_\_ The vegetated part of the wetland is on the shores of a body of permanent open water (without any vegetation on the surface) where at least 20 acres (8ha) in size;

\_\_\_\_\_ At least 30% of the open water area is deeper than 6.6 (2 m)?

**NO – go to 4**

**YES – The wetland class is Lake-fringe (Lacustrine Fringe)**

4. Does the entire wetland meet all of the following criteria?

\_\_\_\_\_ The wetland is on a slope (*slope can be very gradual*).

\_\_\_\_\_ The water flows through the wetland in one direction (unidirectional) and usually comes from seeps. It may flow subsurface, as sheetflow, or in a swale without distinct banks.

\_\_\_\_\_ The water leaves the wetland **without being impounded**?

*NOTE: Surface water does not pond in these types of wetlands except occasionally in very small and shallow depressions or behind hummocks (depressions are usually <3 ft diameter and less than 1 foot deep).*

**NO – go to 5**

**YES – The wetland class is Slope**

5. Does the entire wetland meet all of the following criteria?

\_\_\_\_\_ The unit is in a valley or stream channel where it gets inundated by overbank flooding from that stream or river.

\_\_\_\_\_ The overbank flooding occurs at least once every two years.

*NOTE: The riverine unit can contain depressions that are filled with water when the river is not flooding..*

**NO – go to 6**

**YES – The wetland class is Riverine**

6. Is the entire wetland unit in a topographic depression in which water ponds, or is saturated to the surface, at some time of the year. This means that any outlet, if present is higher than the interior of the wetland.

**NO – go to 7**

**YES – The wetland class is Depressional**

7. Is the entire wetland located in a very flat area with no obvious depression and no overbank flooding. The unit does not pond surface water more than a few inches. The unit seems to be maintained by high groundwater in the area. The wetland may be ditched, but has no obvious natural outlet.

**No – go to 8**

**YES – The wetland class is Depressional**

8. Your wetland unit seems to be difficult to classify and probably contains several different HGM classes. For example, seeps at the base of a slope may grade into a riverine floodplain, or a small stream within a depressional wetland has a zone of flooding along its sides. **GO BACK AND IDENTIFY WHICH OF THE HYDROLOGIC REGIMES DESCRIBED IN QUESTIONS 1-7 APPLY TO DIFFERENT AREAS IN THE UNIT** (make a rough sketch to help you decide). Use the following table to identify the appropriate class to use for the rating system if you have several HGM classes present within your wetland. **NOTE:** Use this table only if the class that is recommended in the second column represents 10% or more of the total area of the wetland unit being rated. If the area of the class listed in column 2 is less than 10% of the unit, classify the wetland using the class that represents more than 90% of the total area.

<i>HGM Classes within the wetland unit being rated</i>	<i>HGM Class to Use in Rating</i>
Slope + Riverine	Riverine
<b>Slope + Depressional</b>	<b>Depressional</b>
Slope + Lake-fringe	Lake-fringe
Depressional + Riverine along stream within boundary	Depressional
Depressional + Lake-fringe	Depressional
Salt Water Tidal Fringe and any other class of freshwater wetland	Treat as ESTUARINE under wetlands with special characteristics

**Exhibit 16**

**SSDP2016-00415**

**001217**





If you are unable still to determine which of the above criteria apply to your wetland, or you have more than 2 HGM classes within a wetland boundary, classify the wetland as **Depressional** for the rating.

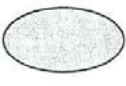

<b>D 4</b>	<p><b>Does the wetland have the <u>opportunity</u> to reduce flooding and erosion?</b></p> <p>Answer YES if the unit is in a location in the watershed where the flood storage, or reduction in water velocity, it provides helps protect downstream property and aquatic resources from flooding or excessive and/or erosive flows. Answer NO if the water coming into the wetland is controlled by a structure such as flood gate, tide gate, flap valve, reservoir etc. OR you estimate that more than 90% of the water in the wetland is from groundwater in areas where damaging groundwater flooding does not occur. <i>Note which of the following indicators of opportunity apply.</i></p> <p><input type="checkbox"/> Wetland is in a headwater of a river or stream that has flooding problems.</p> <p><input type="checkbox"/> Wetland drains to a river or stream that has flooding problems</p> <p><input type="checkbox"/> Wetland has no outlet and impounds surface runoff water that might otherwise flow into a river or stream that has flooding problems</p> <p><input type="checkbox"/> Other _____</p> <p>YES multiplier is 2      NO multiplier is 1</p>	<p>(see p. 49)</p> <p>Multiplier</p> <p>X1</p>
◆	<p><b>TOTAL – Hydrologic Functions</b>      Multiply the score from D3 by D4; then <i>add score to table on p. 1</i></p>	<p>3</p>

Comments:

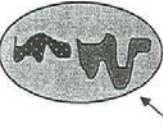

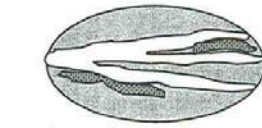
<p><i>These questions apply to wetlands of all HGM classes.</i></p> <p>HABITAT FUNCTIONS – Indicators that wetland functions to provide important habitat.</p>		<p><b>Points</b> (only 1 score per box)</p>
<b>H 1</b>	<b>Does the wetland have the <u>potential</u> to provide habitat for many species?</b>	
H 1.1	<p><u>Vegetation structure</u> (see P. 72): Check the types of vegetation classes present (as defined by Cowardin) – Size threshold for each class is 1/4 acre or more than 10% of the area if unit is smaller than 2.5 acres.</p> <p><input type="checkbox"/> Aquatic Bed <input type="checkbox"/> Emergent plants <input checked="" type="checkbox"/> Scrub/shrub (areas where shrubs have &gt; 30% cover) <input type="checkbox"/> Forested (areas where trees have &gt; 30% cover)</p> <p>If the unit has a forested class check if: <input type="checkbox"/> The forested class has 3 out of 5 strata (canopy, sub-canopy, shrubs, herbaceous, moss/ground-cover) that each cover 20% within the forested polygon. Add the number of vegetation types that qualify. If you have:</p> <p>4 structures or more..... points = 4 3 structures..... points = 2 1 structure..... points = 0</p> <p><b>Map of Cowardin vegetation classes</b></p>	<p><b>Figure</b> ____</p> <p>0</p>
H 1.2	<p><u>Hydroperiods</u> (see p.73): Check the types of water regimes (hydroperiods) present within the wetland. The water regime has to cover more than 10% of the wetland or 1/4 acre to count (see text for descriptions of hydroperiods).</p> <p><input type="checkbox"/> Permanently flooded or inundated <input type="checkbox"/> Seasonally flooded or inundated <input type="checkbox"/> Occasionally flooded or inundated <input checked="" type="checkbox"/> Saturated only</p> <p>4 or more types present points = 3 3 or more types present..... points = 2 2 types present..... points = 1 1 type present..... points = 0</p> <p><input type="checkbox"/> Permanently flowing stream or river in, or adjacent to, the wetland <input type="checkbox"/> Seasonally flowing stream in, or adjacent to, the wetland <input type="checkbox"/> <b>Lake-fringe wetland..... = 2 points</b> <input type="checkbox"/> <b>Freshwater tidal wetland..... = 2 points</b></p> <p><b>Map of hydroperiods</b></p>	<p><b>Figure</b> ____</p> <p>0</p>
H 1.3	<p><u>Richness of Plant Species</u> (see p. 75): Count the number of plant species in the wetland that cover at least 10 ft<sup>2</sup> (different patches of the same species can be combined to meet the size threshold) You do not have to name the species. Do not include Eurasian Milfoil, reed canarygrass, purple loosestrife, Canadian Thistle.</p> <p>If you counted: &gt; 19 species ..... points = 2 5 – 19 species..... points = 1 &lt; 5 species ..... points = 0</p> <p>List species below if you want to: _____ _____ _____</p>	<p>1</p>
H 1.4	<p><u>Interspersion of Habitats</u> (see p. 76): Decided from the diagrams below whether interspersion between Cowardin vegetation (described in H1.1), or the classes and unvegetated areas (can include open water or mudflats) is high, medium, low, or none.</p> <div style="display: flex; justify-content: space-around;"> <div style="text-align: center;">  <p>None = 0 points</p> </div> <div style="text-align: center;">  <p>Low = 1 point</p> </div> <div style="text-align: center;">  <p>Moderate = 2 points</p> </div> </div> <div style="display: flex; justify-content: space-around; margin-top: 20px;"> <div style="text-align: center;">  <p>High = 3 points</p> </div> <div style="text-align: center;">  <p>High = 3 points</p> </div> <div style="text-align: center;">  <p>[riparian braided channels]</p> </div> </div> <p>Note: If you have 4 or more classes or 3 vegetation classes and open water, the rating is always “high”. <b>Use map of Cowardin classes.</b></p>	<p><b>Figure</b> ____</p> <p>0</p>
H 1.5	<p><u>Special Habitat Features</u> (see p. 77): Check the habitat features that are present in the wetland. The number of checks is the number of points you put into the next column.</p> <p><input type="checkbox"/> Large, downed, woody debris within the wetland (&gt; 4 in. diameter and 6 ft. long) <input type="checkbox"/> Standing snags (diameter at the bottom &gt; 4 inches) in the wetland <input type="checkbox"/> Undercut banks are present for at least 6.6 ft. (2m) and/or overhanging vegetation extends at least 3.3 ft. (1m) over a stream (or ditch) in, or contiguous with the unit, for at least 33 ft. (10m) <input type="checkbox"/> Stable steep banks of fine material that might be used by beaver or muskrat for denning (&gt; 30 degree slope) OR signs of recent beaver activity are present (cut shrubs or trees that have not yet turned grey/brown) <input type="checkbox"/> At least 1/4 acre of thin-stemmed persistent vegetation or woody branches are present in areas that are permanently or seasonally inundated (structures for egg-laying by amphibians) <input type="checkbox"/> Invasive plants cover less than 25% of the wetland area in each stratum of plants</p> <p>NOTE: The 20% stated in early printings of the manual on page 78 is an error.</p>	<p>0</p>
<b>H 1 TOTAL Score – potential for providing habitat</b>		<p>Add the points in the column.</p> <p><b>001220</b></p> <p>1</p>

<b>H 2</b>	<b>Does the wetland have the <u>opportunity</u> to provide habitat for many species?</b>	(only 1 score per box)
	<p>H 2.1 <u>Buffers</u> (see P. 80):  <i>Choose the description that best represents condition of buffer of wetland unit. The highest scoring criterion that applies to the wetland is to be used in the rating. See text for definition of "undisturbed".</i></p> <p>___ 100m (330 ft) of relatively undisturbed vegetated areas, rocky areas, or open water &gt; 95% of circumference. No structures are within the undisturbed part of buffer (relatively undisturbed also means no grazing, no landscaping, no daily human use)..... <b>points = 5</b></p> <p>___ 100m (330 ft) of relatively undisturbed vegetated areas, rocky areas, or open water &gt; 50% circumference ..... <b>points = 4</b></p> <p>___ 50m (170 ft) of relatively undisturbed vegetated areas, rocky areas, or open water &gt; 95% circumference ..... <b>points = 4</b></p> <p>___ 100m (330 ft) of relatively undisturbed vegetated areas, rocky areas, or open water &gt; 25% circumference ..... <b>points = 3</b></p> <p>___ 50m (170 ft) of relatively undisturbed vegetated areas, rocky areas, or open water for &gt; 50% circumference ..... <b>points = 3</b></p> <p><b>If buffer does not meet any of the criteria above:</b></p> <p>___ No paved areas (except paved trails) or buildings within 25m (80 ft) of wetland &gt; 95% circumference. Light to moderate grazing or lawns are OK ..... <b>points = 2</b></p> <p>___ No paved areas of buildings within 50m of wetland for &gt; 50% circumference. Light to moderate grazing or lawns are OK..... <b>points = 2</b></p> <p>___ Heavy grazing in buffer ..... <b>points = 1</b></p> <p>___ Vegetated buffers are &lt; 2m wide (6.6 ft) for more than 95% circumference (e.g. tilled fields, paving, basalt bedrock extend to edge of wetland) ..... <b>points = 0</b></p> <p><u>X</u> Buffer does not meet any of the criteria above ..... <b>points = 1</b></p> <p style="text-align: right;"><b>Arial photo showing buffers</b></p>	<p><b>Figure</b> ____</p> <p style="text-align: center;">1</p>
	<p>H 2.2 <u>Corridors and Connections</u> (see p. 81)</p> <p>H 2.2.1 Is the wetland part of a relatively undisturbed and unbroken vegetated corridor (either riparian or upland) that is at least 150 ft. wide, has at least a 30% cover of shrubs, forest or native undisturbed prairie, that connects to estuaries, other wetlands or undisturbed uplands that are at least 250 acres in size? (<i>Dams in riparian corridors, heavily used gravel roads, paved roads, are considered breaks in the corridor.</i>)</p> <p style="text-align: center;">YES = <b>4 points</b> (go to H 2.3) <span style="margin-left: 100px;"><b>NO = go to H 2.2.2</b></span></p> <p>H. 2.2.2 Is the wetland part of a relatively undisturbed and unbroken vegetated corridor (either riparian or upland) that is at least 50 ft. wide, has at least 30% cover of shrubs or forest, and connects to estuaries, other wetlands or undisturbed uplands that are at least 25 acres in size? <b>OR a Lake-fringe wetland, if it does not have an undisturbed corridor as in the question above?</b></p> <p style="text-align: center;">YES = <b>2 points</b> (go to H 2.3) <span style="margin-left: 100px;"><b>NO = go to H 2.2.3</b></span></p> <p>H. 2.2.3 Is the wetland:</p> <ul style="list-style-type: none"> <li>• Within 5 mi (8km) of a brackish or salt water estuary OR</li> <li>• Within 3 miles of a large field or pasture (&gt; 40 acres) OR <span style="float: right;"><b>YES = 1 point</b></span></li> <li>• <b>Within 1 mile of a lake greater than 20 acres?</b> <span style="float: right;"><b>NO = 0 points</b></span></li> </ul>	<p style="text-align: center;">1</p>

Comments:

	<p>H 2.3 <u>Near or adjacent to other priority habitats listed by WDFW</u> (see p. 82): (see new and complete descriptions of WDFW priority habitats, and the counties in which they can be found, in the PHS report <a href="http://wdfw.wa.gov/hab/phslist.htm">http://wdfw.wa.gov/hab/phslist.htm</a> )</p> <p>Which of the following priority habitats are within 330 ft. (100m) of the wetland unit?  <i>NOTE: the connections do not have to be relatively undisturbed.</i></p> <p>___ <b>Aspen Stands:</b> Pure or mixed stands of aspen greater than 0.4 ha (1 acre).</p> <p>___ <b>Biodiversity Areas and Corridors:</b> Areas of habitat that are relatively important to various species of native fish and wildlife (full descriptions in WDFW PHS report p. 152).</p> <p>___ <b>Herbaceous Balds:</b> Variable size patches of grass and forbs on shallow soils over bedrock.</p> <p>___ <b>Old-growth/Mature forests:</b> (Old-growth west of Cascade crest) Stands of at least 2 tree species, forming a multi-layered canopy with occasional small openings; with at least 20 trees/ha (8 trees/acre) &gt; 81 cm (32 in) dbh or &gt; 200 years of age. (Mature forests) Stands with average diameters exceeding 53 cm (21 in) dbh; crown cover may be less than 100%; decay, decadence, numbers of snags, and quantity of large downed material is generally less than that found in old-growth; 80 - 200 years old west of the Cascade crest.</p> <p>___ <b>Oregon white Oak:</b> Woodlands Stands of pure oak or oak/conifer associations where canopy coverage of the oak component is important (full descriptions in WDFW PHS report p. 158).</p> <p>___ <b>Riparian:</b> The area adjacent to aquatic systems with flowing water that contains elements of both aquatic and terrestrial ecosystems which mutually influence each other.</p> <p>___ <b>Westside Prairies:</b> Herbaceous, non-forested plant communities that can either take the form of a dry prairie or a wet prairie (full descriptions in WDFW PHS report p. 161).</p> <p>___ <b>Instream:</b> The combination of physical, biological, and chemical processes and conditions that interact to provide functional life history requirements for instream fish and wildlife resources.</p> <p>___ <b>Nearshore:</b> Relatively undisturbed nearshore habitats. These include Coastal Nearshore, Open Coast Nearshore, and Puget Sound Nearshore. (full descriptions of habitats and the definition of relatively undisturbed are in WDFW report: pp. 167-169 and glossary in Appendix A).</p> <p>___ <b>Caves:</b> A naturally occurring cavity, recess, void, or system of interconnected passages under the earth in soils, rock, ice, or other geological formations and is large enough to contain a human.</p> <p>___ <b>Cliffs:</b> Greater than 7.6 m (25 ft) high and occurring below 5000 ft.</p> <p>___ <b>Talus:</b> Homogenous areas of rock rubble ranging in average size 0.15 - 2.0 m (0.5 - 6.5 ft), composed of basalt, andesite, and/or sedimentary rock, including riprap slides and mine tailings. May be associated with cliffs.</p> <p>___ <b>Snags and Logs:</b> Trees are considered snags if they are dead or dying and exhibit sufficient decay characteristics to enable cavity excavation/use by wildlife. Priority snags have a diameter at breast height of &gt; 51 cm (20 in) in western Washington and are &gt; 2 m (6.5 ft) in height. Priority logs are &gt; 30 cm (12 in) in diameter at the largest end, and &gt; 6 m (20 ft) long.</p> <p>If wetland has <b>3 or more</b> priority habitats = <b>4 points</b>                  If wetland has <b>2</b> priority habitats = <b>3 points</b>                  If wetland has <b>1</b> priority habitat = <b>1 point</b>                      <b>No habitats = 0 points</b></p> <p>Note: All vegetated wetlands are by definition a priority habitat but are not included in this list. Nearby wetlands are addressed in question H 2.4)</p>	0
	<p>H 2.4 <u>Wetland Landscape:</u> Choose the <b>one</b> description of the landscape around the wetland that best fits (see p. 84)</p> <ul style="list-style-type: none"> <li>• There are at least 3 other wetlands within 1/2 mile, and the connections between them are relatively undisturbed (light grazing between wetlands OK, as is lake shore with some boating, but connections should NOT be bisected by paved roads, fill, fields, or other development.....points = 5</li> <li>• The wetland is Lake-fringe on a lake with little disturbance and there are 3 other lake-fringe wetlands within 1/2 mile .....points = 5</li> <li>• <b>There are at least 3 other wetlands within 1/2 mile, BUT the connections between them are disturbed.....points = 3</b></li> <li>• The wetland fringe on a lake <b>with</b> disturbance and there are 3 other lake-fringe wetlands within 1/2 mile .....points = 3</li> <li>• There is at least 1 wetland within 1/2 mile .....points = 2</li> <li>• There are no wetlands within 1/2 mile.....points = 0</li> </ul>	3
	<p><b>H 2 TOTAL Score</b> – opportunity for providing habitat                      <i>Add the scores from H2.1, H2.2, H2.3, H2.4</i></p>	5
	<p style="text-align: right;"><i>TOTAL for H 1 from page 8</i></p>	1
◆	<p><b>Total Score for Habitat Functions</b>                      Add the points for H 1 and H 2; then <b>record the result on p. 1</b></p>	6

Comments:

### CATEGORIZATION BASED ON SPECIAL CHARACTERISTICS

*Please determine if the wetland meets the attributes described below  
and circle the appropriate answers and Category.*

<b>Wetland Type</b> – Check off any criteria that apply to the wetland. Circle the Category when the appropriate criteria are met.	
<b>SC1</b>	<p><b>Estuarine wetlands?</b> (see p.86)</p> <p>Does the wetland unit meet the following criteria for Estuarine wetlands?</p> <p><input type="checkbox"/> The dominant water regime is tidal,  <input type="checkbox"/> Vegetated, and  <input type="checkbox"/> With a salinity greater than 0.5 ppt.</p> <p style="text-align: center;">YES = Go to SC 1.1                      NO <u>  X  </u></p>
	<p>SC 1.1 Is the wetland unit within a National Wildlife Refuge, National Park, National Estuary Reserve, Natural Area Preserve, State Park or Educational, Environmental, or Scientific Reserve designated under WAC 332-30-151?    YES = Category I                      NO = go to SC 1.2</p>
	<p>SC 1.2 Is the wetland at least 1 acre in size and meets at least two of the following conditions?</p> <p style="text-align: center;">YES = Category I                      NO = Category II</p> <p><input type="checkbox"/> The wetland is relatively undisturbed (has no diking, ditching, filling, cultivation, grazing, and has less than 10% cover of non-native plant species. If the non-native <i>Spartina</i> spp., are only species that cover more than 10% of the wetland, then the wetland should be given a dual rating (I/II). The area of <i>Spartina</i> would be rated a Category II while the relatively undisturbed upper marsh with native species would be a Category I. Do not, however, exclude the area of <i>Spartina</i> in determining the size threshold of 1 acre.</p> <p><input type="checkbox"/> At least 3/4 of the landward edge of the wetland has a 100 ft. buffer of shrub, forest, or un-grazed or un-mowed grassland</p> <p><input type="checkbox"/> The wetland has at least 2 of the following features: tidal channels, depressions with open water, or contiguous freshwater wetlands.</p>
	<p><b>Cat. I</b></p> <p><b>Cat. II</b></p> <p><b>Dual Rating I/II</b></p>
<b>SC2</b>	<p><b>Natural Heritage Wetlands</b> (see p. 87)</p> <p>Natural Heritage wetlands have been identified by the Washington Natural Heritage Program/DNR as either high quality undisturbed wetlands or wetlands that support state Threatened, Endangered, or Sensitive plant species.</p> <p>SC 2.1 Is the wetland being rated in a Section/Township/Range that contains a natural heritage wetland? (<i>This question is used to screen out most sites before you need to contact WNHP/DNR.</i>)</p> <p style="text-align: center;">S/T/R information from Appendix D _____ or accessed from WNHP/DNR web site _____</p> <p style="text-align: center;">YES _____ Contact WNHP/DNR (see p. 79) and go to SC 2.2                      NO <u>  X  </u></p> <p>SC 2.2 Has DNR identified the wetland as a high quality undisturbed wetland or as a site with state threatened or endangered plant species?</p> <p style="text-align: center;">YES = Category 1                      NO _____ not a Heritage Wetland</p>
	<p><b>Cat I</b></p>
<b>SC3</b>	<p><b>Bogs</b> (see p. 87)</p> <p>Does the wetland (<b>or any part of the unit</b>) meet both the criteria for soils and vegetation in bogs? Use the key below to identify if the wetland is a bog. <i>If you answer yes you will still need to rate the wetland based on its function.</i></p> <ol style="list-style-type: none"> <li>1. Does the unit have organic soil horizons (i.e. layers of organic soil), either peats or mucks, that compose 16 inches or more of the first 32 inches of soil profile? (See Appendix B for a field key to identify organic soils)?    YES = go to question 3                      <b>NO = go to question 2</b></li> <li>2. Does the wetland have organic soils, either peats or mucks that are less than 16 inches deep over bedrock, or an impermeable hardpan such as clay or volcanic ash, or that are floating on a lake or pond?    YES = go to question 3                      <b>NO = is not a bog for purpose of rating</b></li> <li>3. Does the unit have more than 70% cover of mosses at ground level, AND other plants, if present, consist of the “bog” species listed in Table 3 as a significant component of the vegetation (more than 30% of the total shrub and herbaceous cover consists of species in Table 3)?</li> </ol> <p style="text-align: center;">YES = Is a bog for purpose of rating                      NO = go to question 4</p> <p>NOTE: If you are uncertain about the extent of mosses in the understory you may substitute that criterion by measuring the pH of the water that seeps into a hole dug at least 16” deep. If the pH is less than 5.0 and the “bog” plant species in Table 3 are present, the wetland is a bog.</p> <ol style="list-style-type: none"> <li>4. Is the unit forested (&gt; 30% cover) with sitka spruce, subalpine fir, western red cedar, western hemlock, lodgepole pine, quaking aspen, Englemann’s spruce, or western white pine. WITH any of the species (or combination of species) on the bog species plant list in Table 3 as a significant component of the ground cover (&gt; 30% coverage of the total shrub/herbaceous cover)?</li> </ol> <p style="text-align: center;">YES = Category I                      NO = Is not a bog for purpose of rating</p>
	<p><b>Cat. I</b></p>

**Exhibit 16**  
**SSDP2016-00415**  
**001223**

SC4	<p><b>Forested Wetlands</b> (see p. 90)</p> <p>Does the wetland have at least 1 acre of forest that meet one of these criteria for the Department of Fish and Wildlife's forests as priority habitats? <i>If you answer yes you will still need to rate the wetland based on its function.</i></p> <p>___ <b>Old-growth forests:</b> (west of Cascade Crest) Stands of at least two three species forming a multi-layered canopy with occasional small openings; with at least 8 trees/acre (20 trees/hectare) that are at least 200 years of age OR have a diameter at breast height (dbh) of 32 inches (81 cm or more).</p> <p>NOTE: The criterion for dbh is based on measurements for upland forests. Two-hundred year old trees in wetlands will often have a smaller dbh because their growth rates are often slower. The DFW criterion is and "OR" so old-growth forests do not necessarily have to have trees of this diameter.</p> <p>___ <b>Mature forests:</b> (west of the Cascade Crest) Stands where the largest trees are 80 – 200 years old OR have an average diameters (dbh) exceeding 21 inches (53 cm); crown cover may be less than 100%; decay, decadence, numbers of snags, and quantity of large downed material is generally less than that found in old-growth.</p> <p>YES = Category I                      NO = <u>X</u> not a forested wetland with special characteristics</p>	Cat. I
SC5	<p><b>Wetlands in Coastal Lagoons</b> (see p. 91)</p> <p>Does the wetland meet all of the following criteria of a wetland in a coastal lagoon?</p> <p>___ The wetland lies in a depression adjacent to marine waters that is wholly or partially separated from marine waters by sandbanks, gravel banks, shingle, or, less frequently, rocks.</p> <p>___ The lagoon in which the wetland is located contains surface water that is saline or brackish (&gt; 0.5 ppt) during most of the year in at least a portion of the lagoon (<i>needs to be measured near the bottom.</i>)</p> <p>YES = Go to SC 5.1                      NO <u>X</u> not a wetland in a coastal lagoon</p> <p>SC 5.1 Does the wetland meet all of the following three conditions?</p> <p>___ The wetland is relatively undisturbed (has no diking, ditching, filling, cultivation, grazing) and has less than 20% cover of invasive plant species (see list of invasive species on p. 74).</p> <p>___ At least 3/4 of the landward edge of the wetland has a 100 ft. buffer of shrub, forest, or un-grazed or un-mowed grassland.</p> <p>___ The wetland is larger than 1/10 acre (4350 square ft.)</p> <p>YES = Category I                      NO = Category II</p>	Cat. I Cat. II
SC6	<p><b>Interdunal Wetlands</b> (see p. 93)</p> <p>Is the wetland west of the 1889 line (also called the Western Boundary of Upland Ownership or WBUO)?</p> <p>YES = Go to SC 6.1                      NO <u>X</u> not an interdunal wetland for rating</p> <p><b><i>If you answer yes you will still need to rate the wetland based on its functions.</i></b></p> <p>In practical terms that means the following geographic areas:</p> <ul style="list-style-type: none"> <li>• Long Beach Peninsula -- lands west of SR 103</li> <li>• Grayland-Westport -- lands west of SR 105</li> <li>• Ocean Shores-Copalis – lands west of SR 115 and SR 109</li> </ul> <p>SC 6.1 Is the wetland one acre or larger, or is it in a mosaic of wetlands that is one acre or larger?</p> <p>YES = Category II                      NO = go to SC 6.2</p> <p>SC 6.2 Is the wetland between 0.1 and 1 acre, or is it in a mosaic of wetlands that is between 0.1 and 1 acre?</p> <p>YES = Category III</p>	Cat. II Cat. III
◆	<p><b>Category of wetland based on Special Characteristics</b></p> <p><i>Choose the "highest" rating if wetland falls into several categories, and record on p. 1.</i></p> <p>If you answered NO for all types enter "Not Applicable" on p. 1</p>	NA

Comments:

**Exhibit 16**  
**SSDP2016-00415**  
**001224**

Wetland name or number 28C

**WETLAND RATING FORM – WESTERN WASHINGTON**  
Version 2 – Updated July 2006 to increase accuracy and reproducibility among users  
Updated Oct. 2008 with the new WDFW definitions for priority habitats

Name of wetland (if known): 28C Date of site visit: 09-27-13

Rated by: Colin Worsley / Matt Maynard Trained by Ecology? Yes X No      Date of training: 11-2005 / 04-2006

SEC: 29 TOWNSHIP: 25N RANGE: 06E Is S/T/R in Appendix D? Yes      No X

Map of wetland unit: Figure                      Estimated size 0.09 acre

**SUMMARY OF RATING**

Category based on FUNCTIONS provided by wetland: I      II      III      IV X

Category I =	Score > 70
Category II =	Score 51 - 69
Category III =	Score 30 – 50
Category IV =	Score < 30

Score for Water Quality Functions	12
Score for Hydrologic Functions	3
Score for Habitat Functions	13
<b>TOTAL Score for Functions</b>	<b>28</b>

Category based on SPECIAL CHARACTERISTICS of Wetland I      II      Does not apply X

**Final Category** (choose the “highest” category from above”) **IV**

**Summary of basic information about the wetland unit.**

Wetland Unit has Special Characteristics		Wetland HGM Class used for Rating	
<b>Estuarine</b>		<b>Depressional</b>	<b>X</b>
<b>Natural Heritage Wetland</b>		<b>Riverine</b>	
<b>Bog</b>		<b>Lake-fringe</b>	
<b>Mature Forest</b>		<b>Slope</b>	
<b>Old Growth Forest</b>		<b>Flats</b>	
<b>Coastal Lagoon</b>		<b>Freshwater Tidal</b>	
<b>Interdunal</b>			
None of the above	X	Check if unit has multiple HGM classes present	<span style="border: 1px solid black; padding: 2px;">    </span>

**Does the wetland being rated meet any of the criteria below?** If you answer YES to any of the questions below you will need to protect the wetland according to the regulations regarding the special characteristics found in the wetland.

Check List for Wetlands that Need Additional Protection (in addition to the protection recommended for its category)	YES	NO
SP1. <i>Has the wetland unit been documented as a habitat for any Federally listed Threatened or Endangered <b>animal or plant</b> species (T/E species)?</i> For the purposes of this rating system, “documented” means the wetland is on the appropriate state or federal database.		X
SP2. <i>Has the wetland unit been documented as habitat for any State listed Threatened or Endangered <b>animal</b> species?</i> For the purposes of this rating system, “documented” means the wetland is on the appropriate state database. Note: Wetlands with State listed plant species are categorized as Category 1 Natural Heritage Wetlands (see p. 19 of data form).		X
SP3. <i>Does the wetland unit contain individuals of Priority species listed by the WDFW for the state?</i>		X
SP4. <i>Does the wetland unit have a local significance in addition to its functions?</i> For example, the wetland has been identified in the Shoreline Master Program, the Critical Areas Ordinance, or in a local management plan as having special significance.		X

To complete the next part of the data sheet you will need to determine the Hydrogeomorphic Class of the wetland being rated.

Exhibit 16  
SSDP2016-00415  
001225







<b>D 4</b>	<p><b>Does the wetland have the <u>opportunity</u> to reduce flooding and erosion?</b></p> <p>Answer YES if the unit is in a location in the watershed where the flood storage, or reduction in water velocity, it provides helps protect downstream property and aquatic resources from flooding or excessive and/or erosive flows. Answer NO if the water coming into the wetland is controlled by a structure such as flood gate, tide gate, flap valve, reservoir etc. OR you estimate that more than 90% of the water in the wetland is from groundwater in areas where damaging groundwater flooding does not occur. <i>Note which of the following indicators of opportunity apply.</i></p> <p><input type="checkbox"/> Wetland is in a headwater of a river or stream that has flooding problems.</p> <p><input type="checkbox"/> Wetland drains to a river or stream that has flooding problems</p> <p><input type="checkbox"/> Wetland has no outlet and impounds surface runoff water that might otherwise flow into a river or stream that has flooding problems</p> <p><input type="checkbox"/> Other _____</p> <p>YES multiplier is 2      NO multiplier is 1</p>	<p>(see p. 49)</p> <p>Multiplier</p> <p>X1</p>
◆	<p><b>TOTAL – Hydrologic Functions</b>      Multiply the score from D3 by D4; then <i>add score to table on p. 1</i></p>	<p>5</p>

Comments:

<i>These questions apply to wetlands of all HGM classes.</i> HABITAT FUNCTIONS – Indicators that wetland functions to provide important habitat.		Points (only 1 score per box)
<b>H 1</b>	<b>Does the wetland have the potential to provide habitat for many species?</b>	
H 1.1	<p><u>Vegetation structure</u> (see P. 72):                      Check the types of vegetation classes present (as defined by Cowardin) – Size threshold for each class is 1/4 acre or more than 10% of the area if unit is smaller than 2.5 acres.</p> <p><input type="checkbox"/> Aquatic Bed  <input checked="" type="checkbox"/> Emergent plants  <input checked="" type="checkbox"/> Scrub/shrub (areas where shrubs have &gt; 30% cover)  <input type="checkbox"/> Forested (areas where trees have &gt; 30% cover)</p> <p>If the unit has a forested class check if:  <input type="checkbox"/> The forested class has 3 out of 5 strata (canopy, sub-canopy, shrubs, herbaceous, moss/ground-cover) that each cover 20% within the forested polygon.                      Add the number of vegetation types that qualify. If you have:</p> <p style="text-align: right;"> <b>Map of Cowardin vegetation classes</b>                      4 structures or more ..... points = 4                      3 structures ..... points = 2                      2 structures ..... points = 1                      1 structure ..... points = 0                 </p>	<p>Figure ____</p> <p style="text-align: right;">1</p>
H 1.2	<p><u>Hydroperiods</u> (see p.73):                      Check the types of water regimes (hydroperiods) present within the wetland. The water regime has to cover more than 10% of the wetland or 1/4 acre to count (see text for descriptions of hydroperiods).</p> <p><input type="checkbox"/> Permanently flooded or inundated  <input type="checkbox"/> Seasonally flooded or inundated  <input checked="" type="checkbox"/> Occasionally flooded or inundated  <input checked="" type="checkbox"/> Saturated only  <input checked="" type="checkbox"/> Permanently flowing stream or river in, or adjacent to, the wetland  <input type="checkbox"/> Seasonally flowing stream in, or adjacent to, the wetland  <input type="checkbox"/> Lake-fringe wetland..... = 2 points  <input type="checkbox"/> Freshwater tidal wetland ..... = 2 points</p> <p style="text-align: right;"> <b>Map of hydroperiods</b>                      4 or more types present ..... points = 3                      3 or more types present ..... points = 2                      2 types present ..... points = 1                      1 type present ..... points = 0                 </p>	<p>Figure ____</p> <p style="text-align: right;">2</p>
H 1.3	<p><u>Richness of Plant Species</u> (see p. 75):                      Count the number of plant species in the wetland that cover at least 10 ft<sup>2</sup> (different patches of the same species can be combined to meet the size threshold)                      You do not have to name the species. Do not include Eurasian Milfoil, reed canarygrass, purple loosestrife, Canadian Thistle.</p> <p>If you counted: &gt; 19 species ..... points = 2                      5 – 19 species..... points = 1                      &lt; 5 species ..... points = 0</p> <p>List species below if you want to:                      _____                      _____                      _____</p>	<p style="text-align: right;">1</p>
H 1.4	<p><u>Interspersion of Habitats</u> (see p. 76):                      Decided from the diagrams below whether interspersion between Cowardin vegetation (described in H1.1), or the classes and unvegetated areas (can include open water or mudflats) is high, medium, low, or none.</p> <div style="display: flex; justify-content: space-around;"> <div style="text-align: center;">                           None = 0 points                     </div> <div style="text-align: center;">                           Low = 1 point                     </div> <div style="text-align: center;">                           Moderate = 2 points                     </div> </div> <div style="display: flex; justify-content: space-around; margin-top: 20px;"> <div style="text-align: center;">                           High = 3 points                     </div> <div style="text-align: center;">                           [riparian braided channels]                     </div> </div> <p style="text-align: right; margin-right: 50px;">                     Note: If you have 4 or more classes or 3 vegetation classes and open water, the rating is always “high”.                       Use map of Cowardin classes.                 </p>	<p>Figure ____</p> <p style="text-align: right;">1</p>
H 1.5	<p><u>Special Habitat Features</u> (see p. 77):                      Check the habitat features that are present in the wetland. The number of checks is the number of points you put into the next column.</p> <p><input type="checkbox"/> Large, downed, woody debris within the wetland (&gt; 4 in. diameter and 6 ft. long)  <input type="checkbox"/> Standing snags (diameter at the bottom &gt; 4 inches) in the wetland  <input type="checkbox"/> Undercut banks are present for at least 6.6 ft. (2m) and/or overhanging vegetation extends at least 3.3 ft. (1m) over a stream (or ditch) in, or contiguous with the unit, for at least 33 ft. (10m)  <input type="checkbox"/> Stable steep banks of fine material that might be used by beaver or muskrat for denning (&gt; 30 degree slope) OR signs of recent beaver activity are present (cut shrubs or trees that have not yet turned grey/brown)  <input type="checkbox"/> At least 1/4 acre of thin-stemmed persistent vegetation or woody branches are present in areas that are permanently or seasonally inundated (structures for egg-laying by amphibians)  <input type="checkbox"/> Invasive plants cover less than 25% of the wetland area in each stratum of plants</p> <p><i>NOTE: The 20% stated in early printings of the manual on page 78 is an error.</i></p>	<p style="text-align: right;">0</p>
<b>H 1 TOTAL Score</b> – potential for providing habitat		<p style="text-align: right;">5</p>

Exhibit 16  
SSDP2016-00415  
001229



	<p>H 2.3 <u>Near or adjacent to other priority habitats listed by WDFW</u> (see p. 82): (see new and complete descriptions of WDFW priority habitats, and the counties in which they can be found, in the PHS report <a href="http://wdfw.wa.gov/hab/phslist.htm">http://wdfw.wa.gov/hab/phslist.htm</a> )</p> <p>Which of the following priority habitats are within 330 ft. (100m) of the wetland unit?  <i>NOTE: the connections do not have to be relatively undisturbed.</i></p> <p><input type="checkbox"/> <b>Aspen Stands:</b> Pure or mixed stands of aspen greater than 0.4 ha (1 acre).</p> <p><input type="checkbox"/> <b>Biodiversity Areas and Corridors:</b> Areas of habitat that are relatively important to various species of native fish and wildlife (full descriptions in WDFW PHS report p. 152).</p> <p><input type="checkbox"/> <b>Herbaceous Balds:</b> Variable size patches of grass and forbs on shallow soils over bedrock.</p> <p><input type="checkbox"/> <b>Old-growth/Mature forests:</b> (Old-growth west of Cascade crest) Stands of at least 2 tree species, forming a multi-layered canopy with occasional small openings; with at least 20 trees/ha (8 trees/acre) &gt; 81 cm (32 in) dbh or &gt; 200 years of age. (Mature forests) Stands with average diameters exceeding 53 cm (21 in) dbh; crown cover may be less than 100%; decay, decadence, numbers of snags, and quantity of large downed material is generally less than that found in old-growth; 80 - 200 years old west of the Cascade crest.</p> <p><input type="checkbox"/> <b>Oregon white Oak:</b> Woodlands Stands of pure oak or oak/conifer associations where canopy coverage of the oak component is important (full descriptions in WDFW PHS report p. 158).</p> <p><input checked="" type="checkbox"/> <b>Riparian:</b> The area adjacent to aquatic systems with flowing water that contains elements of both aquatic and terrestrial ecosystems which mutually influence each other.</p> <p><input type="checkbox"/> <b>Westside Prairies:</b> Herbaceous, non-forested plant communities that can either take the form of a dry prairie or a wet prairie (full descriptions in WDFW PHS report p. 161).</p> <p><input checked="" type="checkbox"/> <b>Instream:</b> The combination of physical, biological, and chemical processes and conditions that interact to provide functional life history requirements for instream fish and wildlife resources.</p> <p><input type="checkbox"/> <b>Nearshore:</b> Relatively undisturbed nearshore habitats. These include Coastal Nearshore, Open Coast Nearshore, and Puget Sound Nearshore. (full descriptions of habitats and the definition of relatively undisturbed are in WDFW report: pp. 167-169 and glossary in Appendix A).</p> <p><input type="checkbox"/> <b>Caves:</b> A naturally occurring cavity, recess, void, or system of interconnected passages under the earth in soils, rock, ice, or other geological formations and is large enough to contain a human.</p> <p><input type="checkbox"/> <b>Cliffs:</b> Greater than 7.6 m (25 ft) high and occurring below 5000 ft.</p> <p><input type="checkbox"/> <b>Talus:</b> Homogenous areas of rock rubble ranging in average size 0.15 - 2.0 m (0.5 - 6.5 ft), composed of basalt, andesite, and/or sedimentary rock, including riprap slides and mine tailings. May be associated with cliffs.</p> <p><input type="checkbox"/> <b>Snags and Logs:</b> Trees are considered snags if they are dead or dying and exhibit sufficient decay characteristics to enable cavity excavation/use by wildlife. Priority snags have a diameter at breast height of &gt; 51 cm (20 in) in western Washington and are &gt; 2 m (6.5 ft) in height. Priority logs are &gt; 30 cm (12 in) in diameter at the largest end, and &gt; 6 m (20 ft) long.</p> <p>If wetland has <b>3 or more</b> priority habitats = <b>4 points</b>  <b>If wetland has 2</b> priority habitats = <b>3 points</b>                  If wetland has <b>1</b> priority habitat = <b>1 point</b>                      No habitats = 0 points</p> <p>Note: All vegetated wetlands are by definition a priority habitat but are not included in this list. Nearby wetlands are addressed in question H 2.4)</p>	3
	<p>H 2.4 <u>Wetland Landscape:</u> Choose the <b>one</b> description of the landscape around the wetland that best fits (see p. 84)</p> <ul style="list-style-type: none"> <li>• There are at least 3 other wetlands within 1/2 mile, and the connections between them are relatively undisturbed (light grazing between wetlands OK, as is lake shore with some boating, but connections should NOT be bisected by paved roads, fill, fields, or other development.....points = 5</li> <li>• The wetland is Lake-fringe on a lake with little disturbance and there are 3 other lake-fringe wetlands within 1/2 mile .....points = 5</li> <li>• <b>There are at least 3 other wetlands within 1/2 mile, BUT the connections between them are disturbed.....points = 3</b></li> <li>• The wetland fringe on a lake <b>with</b> disturbance and there are 3 other lake-fringe wetlands within 1/2 mile .....points = 3</li> <li>• There is at least 1 wetland within 1/2 mile .....points = 2</li> <li>• There are no wetlands within 1/2 mile.....points = 0</li> </ul>	3
<p><b>H 2 TOTAL Score</b> – opportunity for providing habitat      Add the scores from H2.1, H2.2, H2.3, H2.4</p>		8
<p><i>TOTAL for H 1 from page 8</i></p>		5
◆	<p><b>Total Score for Habitat Functions</b>                      Add the points for H 1 and H 2; then <b>record the result on p. 1</b></p>	13

Comments:

## CATEGORIZATION BASED ON SPECIAL CHARACTERISTICS

*Please determine if the wetland meets the attributes described below  
and circle the appropriate answers and Category.*

<b>Wetland Type</b> – Check off any criteria that apply to the wetland. Circle the Category when the appropriate criteria are met.	
<b>SC1</b>	<b>Estuarine wetlands?</b> (see p.86) Does the wetland unit meet the following criteria for Estuarine wetlands? <input type="checkbox"/> The dominant water regime is tidal, <input type="checkbox"/> Vegetated, and <input type="checkbox"/> With a salinity greater than 0.5 ppt. <div style="text-align: center;">YES = Go to SC 1.1                      NO <u>  X  </u></div>
SC 1.1	Is the wetland unit within a National Wildlife Refuge, National Park, National Estuary Reserve, Natural Area Preserve, State Park or Educational, Environmental, or Scientific Reserve designated under WAC 332-30-151?    YES = Category I                      NO = go to SC 1.2 <div style="text-align: right;"><b>Cat. 1</b></div>
SC 1.2	Is the wetland at least 1 acre in size and meets at least two of the following conditions? <div style="display: flex; justify-content: space-between;"> <span>YES = Category I</span> <span>NO = Category II</span> </div> <input type="checkbox"/> The wetland is relatively undisturbed (has no diking, ditching, filling, cultivation, grazing, and has less than 10% cover of non-native plant species. If the non-native <i>Spartina</i> spp., are only species that cover more than 10% of the wetland, then the wetland should be given a dual rating (I/II). The area of <i>Spartina</i> would be rated a Category II while the relatively undisturbed upper marsh with native species would be a Category I. Do not, however, exclude the area of <i>Spartina</i> in determining the size threshold of 1 acre. <input type="checkbox"/> At least 3/4 of the landward edge of the wetland has a 100 ft. buffer of shrub, forest, or un-grazed or un-mowed grassland <input type="checkbox"/> The wetland has at least 2 of the following features: tidal channels, depressions with open water, or contiguous freshwater wetlands. <div style="text-align: right;"><b>Cat. I</b> <b>Cat. II</b> <b>Dual Rating I/II</b></div>
<b>SC2</b>	<b>Natural Heritage Wetlands</b> (see p. 87) Natural Heritage wetlands have been identified by the Washington Natural Heritage Program/DNR as either high quality undisturbed wetlands or wetlands that support state Threatened, Endangered, or Sensitive plant species. SC 2.1 Is the wetland being rated in a Section/Township/Range that contains a natural heritage wetland? (This question is used to screen out most sites before you need to contact WNHP/DNR.) S/T/R information from Appendix D _____ or accessed from WNHP/DNR web site _____ YES _____ Contact WNHP/DNR (see p. 79) and go to SC 2.2                      NO <u>  X  </u> SC 2.2 Has DNR identified the wetland as a high quality undisturbed wetland or as a site with state threatened or endangered plant species? YES = Category 1                      NO _____ not a Heritage Wetland <div style="text-align: right;"><b>Cat I</b></div>
<b>SC3</b>	<b>Bogs</b> (see p. 87) Does the wetland (or any part of the unit) meet both the criteria for soils and vegetation in bogs? Use the key below to identify if the wetland is a bog. <b>If you answer yes you will still need to rate the wetland based on its function.</b> 1. Does the unit have organic soil horizons (i.e. layers of organic soil), either peats or mucks, that compose 16 inches or more of the first 32 inches of soil profile? (See Appendix B for a field key to identify organic soils)?    YES = go to question 3 <b>NO = go to question 2</b> 2. Does the wetland have organic soils, either peats or mucks that are less than 16 inches deep over bedrock, or an impermeable hardpan such as clay or volcanic ash, or that are floating on a lake or pond?    YES = go to question 3 <b>NO = is not a bog for purpose of rating</b> 3. Does the unit have more than 70% cover of mosses at ground level, AND other plants, if present, consist of the “bog” species listed in Table 3 as a significant component of the vegetation (more than 30% of the total shrub and herbaceous cover consists of species in Table 3)? YES = Is a bog for purpose of rating                      NO = go to question 4 NOTE: If you are uncertain about the extent of mosses in the understory you may substitute that criterion by measuring the pH of the water that seeps into a hole dug at least 16” deep. If the pH is less than 5.0 and the “bog” plant species in Table 3 are present, the wetland is a bog. 4. Is the unit forested (> 30% cover) with sitka spruce, subalpine fir, western red cedar, western hemlock, lodgepole pine, quaking aspen, Englemann’s spruce, or western white pine. WITH any of the species (or combination of species) on the bog species plant list in Table 3 as a significant component of the ground cover (> 30% coverage of the total shrub/herbaceous cover)? YES = Category I                      NO = Is not a bog for purpose of rating <div style="text-align: right;"><b>Cat. I</b></div>

Exhibit 16  
SSDP2016-00415  
001232

<p><b>SC4</b></p>	<p><b>Forested Wetlands</b> (see p. 90)                  Does the wetland have at least 1 acre of forest that meet one of these criteria for the Department of Fish and Wildlife's forests as priority habitats? <i>If you answer yes you will still need to rate the wetland based on its function.</i>                  ___ <b>Old-growth forests:</b> (west of Cascade Crest) Stands of at least two three species forming a multi-layered canopy with occasional small openings; with at least 8 trees/acre (20 trees/hectare) that are at least 200 years of age OR have a diameter at breast height (dbh) of 32 inches (81 cm or more).                  NOTE: The criterion for dbh is based on measurements for upland forests. Two-hundred year old trees in wetlands will often have a smaller dbh because their growth rates are often slower. The DFW criterion is and "OR" so old-growth forests do not necessarily have to have trees of this diameter.                  ___ <b>Mature forests:</b> (west of the Cascade Crest) Stands where the largest trees are 80 – 200 years old OR have an average diameters (dbh) exceeding 21 inches (53 cm); crown cover may be less than 100%; decay, decadence, numbers of snags, and quantity of large downed material is generally less than that found in old-growth.                  YES = Category I                      NO = <u>X</u> not a forested wetland with special characteristics</p>	<p><b>Cat. I</b></p>
<p><b>SC5</b></p>	<p><b>Wetlands in Coastal Lagoons</b> (see p. 91)                  Does the wetland meet all of the following criteria of a wetland in a coastal lagoon?                  ___ The wetland lies in a depression adjacent to marine waters that is wholly or partially separated from marine waters by sandbanks, gravel banks, shingle, or, less frequently, rocks.                  ___ The lagoon in which the wetland is located contains surface water that is saline or brackish (&gt; 0.5 ppt) during most of the year in at least a portion of the lagoon (<i>needs to be measured near the bottom.</i>)                  YES = Go to SC 5.1                      NO <u>X</u> not a wetland in a coastal lagoon                  SC 5.1 Does the wetland meet all of the following three conditions?                  ___ The wetland is relatively undisturbed (has no diking, ditching, filling, cultivation, grazing) and has less than 20% cover of invasive plant species (see list of invasive species on p. 74).                  ___ At least 3/4 of the landward edge of the wetland has a 100 ft. buffer of shrub, forest, or un-grazed or un-mowed grassland.                  ___ The wetland is larger than 1/10 acre (4350 square ft.)                  YES = Category I                      NO = Category II</p>	<p><b>Cat. I</b>  <b>Cat. II</b></p>
<p><b>SC6</b></p>	<p><b>Interdunal Wetlands</b> (see p. 93)                  Is the wetland west of the 1889 line (also called the Western Boundary of Upland Ownership or WBUO)?                  YES = Go to SC 6.1                      NO <u>X</u> not an interdunal wetland for rating  <i>If you answer yes you will still need to rate the wetland based on its functions.</i>                  In practical terms that means the following geographic areas:                  • Long Beach Peninsula -- lands west of SR 103                  • Grayland-Westport -- lands west of SR 105                  • Ocean Shores-Copalis – lands west of SR 115 and SR 109                  SC 6.1 Is the wetland one acre or larger, or is it in a mosaic of wetlands that is one acre or larger?                  YES = Category II                      NO = go to SC 6.2                  SC 6.2 Is the wetland between 0.1 and 1 acre, or is it in a mosaic of wetlands that is between 0.1 and 1 acre?                  YES = Category III</p>	<p><b>Cat. II</b>  <b>Cat. III</b></p>
<p>◆</p>	<p><b>Category of wetland based on Special Characteristics</b>                  Choose the "highest" rating if wetland falls into several categories, and record on p. 1.                  If you answered NO for all types enter "Not Applicable" on p. 1</p>	<p><b>NA</b></p>

**Comments:**

Wetland name or number 28D

**WETLAND RATING FORM – WESTERN WASHINGTON**  
Version 2 – Updated July 2006 to increase accuracy and reproducibility among users  
Updated Oct. 2008 with the new WDFW definitions for priority habitats

Name of wetland (if known): 28D Date of site visit: 09-27-13

Rated by: Colin Worsley / Matt Maynard Trained by Ecology? Yes X No      Date of training: 11-2005 / 04-2006

SEC: 29 TOWNSHIP: 25N RANGE: 06E Is S/T/R in Appendix D? Yes      No X

Map of wetland unit: Figure      Estimated size <0.01 acre

**SUMMARY OF RATING**

Category based on FUNCTIONS provided by wetland: I      II      III      IV X

Category I =	Score > 70
Category II =	Score 51 - 69
Category III =	Score 30 – 50
Category IV =	Score < 30

Score for Water Quality Functions	2
Score for Hydrologic Functions	5
Score for Habitat Functions	9
<b>TOTAL Score for Functions</b>	<b>16</b>

Category based on SPECIAL CHARACTERISTICS of Wetland I      II      Does not apply X

**Final Category** (choose the “highest” category from above”) **IV**

**Summary of basic information about the wetland unit.**

Wetland Unit has Special Characteristics		Wetland HGM Class used for Rating	
<b>Estuarine</b>		<b>Depressional</b>	<b>X</b>
<b>Natural Heritage Wetland</b>		<b>Riverine</b>	
<b>Bog</b>		<b>Lake-fringe</b>	
<b>Mature Forest</b>		<b>Slope</b>	
<b>Old Growth Forest</b>		<b>Flats</b>	
<b>Coastal Lagoon</b>		<b>Freshwater Tidal</b>	
<b>Interdunal</b>			
None of the above	X	Check if unit has multiple HGM classes present	<span style="border: 1px solid black; padding: 2px 10px;">    </span>

**Does the wetland being rated meet any of the criteria below?** If you answer YES to any of the questions below you will need to protect the wetland according to the regulations regarding the special characteristics found in the wetland.

Check List for Wetlands that Need Additional Protection (in addition to the protection recommended for its category)		YES	NO
SP1. <i>Has the wetland unit been documented as a habitat for any Federally listed Threatened or Endangered <b>animal or plant</b> species (T/E species)?</i> For the purposes of this rating system, “documented” means the wetland is on the appropriate state or federal database.			X
SP2. <i>Has the wetland unit been documented as habitat for any State listed Threatened or Endangered <b>animal</b> species?</i> For the purposes of this rating system, “documented” means the wetland is on the appropriate state database. Note: Wetlands with State listed plant species are categorized as Category 1 Natural Heritage Wetlands (see p. 19 of data form).			X
SP3. <i>Does the wetland unit contain individuals of Priority species listed by the WDFW for the state?</i>			X
SP4. <i>Does the wetland unit have a local significance in addition to its functions?</i> For example, the wetland has been identified in the Shoreline Master Program, the Critical Areas Ordinance, or in a local management plan as having special significance.			X

To complete the next part of the data sheet you will need to determine the Hydrogeomorphic Class of the wetland being rated. Exhibit 16

SSDP2016-00415

The hydrogeomorphic classification groups wetlands in to those that function in similar ways. This simplifies the questions needed to answer how well the wetland functions. The Hydrogeomorphic Class of a wetland can be determined using the key below. See p. 24 for more detailed instructions on classifying wetlands.

### Classification of Vegetated Wetlands for Western Washington

If the hydrologic criteria listed in each question do not apply to the entire unit being rated, you probably have a unit with multiple HGM classes. In this case, identify which hydrologic criteria in questions 1-7 apply, and go to Question 8.

1. Are the water levels in the entire unit usually controlled by tides (i.e. except during floods)?  
NO – go to 2                      **YES – the wetland class is Tidal Fringe**  
 If yes, is the salinity of the water during periods of annual low flow below 0.5 ppt (parts per thousand)?  
**YES – Freshwater Tidal Fringe**                      **NO – Saltwater Tidal Fringe (Estuarine)**  
*If your wetland can be classified as a Freshwater Tidal Fringe use the forms for Riverine wetlands. If it is a Saltwater Tidal Fringe it is rated as an Estuarine wetland. Wetlands that were call estuarine in the first and second editions of the rating system are called Salt Water Tidal Fringe in the Hydrogeomorphic Classification. Estuarine wetlands were categorized separately in the earlier editions, and this separation is being kept in this revision. To maintain consistency between editions, the term “Estuarine” wetland is kept. Please note, however, that the characteristics that define Category I and II estuarine wetlands have changed (see p. \_\_\_\_).*

---

2. The entire wetland unit is flat and precipitation is only source (>90%) of water to it. Groundwater and surface water runoff are NOT sources of water to the unit.  
NO – go to 3                      **YES – The wetland class is Flats**  
 If your wetland can be classified as a “Flats” wetland, use the form for **Depressional** wetlands.

---

3. Does the entire wetland meet both of the following criteria?  
 \_\_\_\_\_ The vegetated part of the wetland is on the shores of a body of permanent open water (without any vegetation on the surface) where at least 20 acres (8ha) in size;  
 \_\_\_\_\_ At least 30% of the open water area is deeper than 6.6 (2 m)?  
NO – go to 4                      **YES – The wetland class is Lake-fringe (Lacustrine Fringe)**

---

4. Does the entire wetland meet all of the following criteria?  
 \_\_\_\_\_ The wetland is on a slope (*slope can be very gradual*).  
 \_\_\_\_\_ The water flows through the wetland in one direction (unidirectional) and usually comes from seeps. It may flow subsurface, as sheetflow, or in a swale without distinct banks.  
 \_\_\_\_\_ The water leaves the wetland **without being impounded**?  
 NOTE: *Surface water does not pond in these types of wetlands except occasionally in very small and shallow depressions or behind hummocks (depressions are usually <3 ft diameter and less than 1 foot deep).*  
NO – go to 5                      **YES – The wetland class is Slope**

---

5. Does the entire wetland meet all of the following criteria?  
 \_\_\_\_\_ The unit is in a valley or stream channel where it gets inundated by overbank flooding from that stream or river.  
 \_\_\_\_\_ The overbank flooding occurs at least once every two years.  
 NOTE: *The riverine unit can contain depressions that are filled with water when the river is not flooding..*  
NO – go to 6                      **YES – The wetland class is Riverine**

---

6. Is the entire wetland unit in a topographic depression in which water ponds, or is saturated to the surface, at some time of the year. This means that any outlet, if present is higher than the interior of the wetland.  
NO – go to 7                      **YES – The wetland class is Depressional**

---

7. Is the entire wetland located in a very flat area with no obvious depression and no overbank flooding. The unit does not pond surface water more than a few inches. The unit seems to be maintained by high groundwater in the area. The wetland may be ditched, but has no obvious natural outlet.  
No – go to 8                      **YES – The wetland class is Depressional**

---

8. Your wetland unit seems to be difficult to classify and probably contains several different HGM classes. For example, seeps at the base of a slope may grade into a riverine floodplain, or a small stream within a depressional wetland has a zone of flooding along its sides. **GO BACK AND IDENTIFY WHICH OF THE HYDROLOGIC REGIMES DESCRIBED IN QUESTIONS 1-7 APPLY TO DIFFERENT AREAS IN THE UNIT** (make a rough sketch to help you decide). Use the following table to identify the appropriate class to use for the rating system if you have several HGM classes present within your wetland. NOTE: Use this table only if the class that is recommended in the second column represents 10% or more of the total area of the wetland unit being rated. If the area of the class listed in column 2 is less than 10% of the unit, classify the wetland using the class that represents more than 90% of the total area.

HGM Classes within the wetland unit being rated	HGM Class to Use in Rating
Slope + Riverine	Riverine
Slope + Depressional	Depressional
Slope + Lake-fringe	Lake-fringe
Depressional + Riverine along stream within boundary	Depressional
Depressional + Lake-fringe	Depressional
Salt Water Tidal Fringe and any other class of freshwater wetland	Treat as ESTUARINE under wetlands with special characteristics

**Exhibit 16**  
**SSDP2016-00415**  
**001235**





If you are unable still to determine which of the above criteria apply to your wetland, or you have more than 2 HGM classes within a wetland boundary, classify the wetland as **Depressional** for the rating.



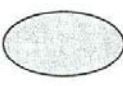
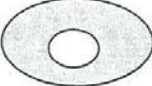

<b>D 4</b>	<p><b>Does the wetland have the <u>opportunity</u> to reduce flooding and erosion?</b></p> <p>Answer YES if the unit is in a location in the watershed where the flood storage, or reduction in water velocity, it provides helps protect downstream property and aquatic resources from flooding or excessive and/or erosive flows. Answer NO if the water coming into the wetland is controlled by a structure such as flood gate, tide gate, flap valve, reservoir etc. OR you estimate that more than 90% of the water in the wetland is from groundwater in areas where damaging groundwater flooding does not occur. <i>Note which of the following indicators of opportunity apply.</i></p> <p><input type="checkbox"/> Wetland is in a headwater of a river or stream that has flooding problems.</p> <p><input type="checkbox"/> Wetland drains to a river or stream that has flooding problems</p> <p><input type="checkbox"/> Wetland has no outlet and impounds surface runoff water that might otherwise flow into a river or stream that has flooding problems</p> <p><input type="checkbox"/> Other _____</p> <p>YES multiplier is 2      NO multiplier is 1</p>	<p>(see p. 49)</p> <p>Multiplier</p> <p>X1</p>
◆	<p><b>TOTAL – Hydrologic Functions</b>      Multiply the score from D3 by D4; then <i>add score to table on p. 1</i></p>	<p>5</p>

Comments:

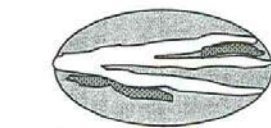
<p><i>These questions apply to wetlands of all HGM classes.</i></p> <p>HABITAT FUNCTIONS – Indicators that wetland functions to provide important habitat.</p>		<p><b>Points</b> (only 1 score per box)</p>
<b>H 1</b>	<b>Does the wetland have the <u>potential</u> to provide habitat for many species?</b>	
H 1.1	<p><u>Vegetation structure</u> (see P. 72):                      Check the types of vegetation classes present (as defined by Cowardin) – Size threshold for each class is 1/4 acre or more than 10% of the area if unit is smaller than 2.5 acres.</p> <p><input type="checkbox"/> Aquatic Bed  <input checked="" type="checkbox"/> Emergent plants  <input type="checkbox"/> Scrub/shrub (areas where shrubs have &gt; 30% cover)  <input type="checkbox"/> Forested (areas where trees have &gt; 30% cover)</p> <p>If the unit has a forested class check if:  <input type="checkbox"/> The forested class has 3 out of 5 strata (canopy, sub-canopy, shrubs, herbaceous, moss/ground-cover) that each cover 20% within the forested polygon.                      Add the number of vegetation types that qualify. If you have:</p> <p>4 structures or more..... points = 4                      3 structures..... points = 2                      2 structures..... points = 1</p> <p style="text-align: right;"><b>Map of Cowardin vegetation classes</b>                      3 structures..... points = 2                      1 structure..... points = 0</p>	<p><b>Figure</b> ____</p> <p style="text-align: right;">0</p>
H 1.2	<p><u>Hydroperiods</u> (see p.73):                      Check the types of water regimes (hydroperiods) present within the wetland. The water regime has to cover more than 10% of the wetland or 1/4 acre to count (see text for descriptions of hydroperiods).</p> <p><input checked="" type="checkbox"/> Permanently flooded or inundated  <input type="checkbox"/> Seasonally flooded or inundated  <input type="checkbox"/> Occasionally flooded or inundated  <input checked="" type="checkbox"/> Saturated only</p> <p><input type="checkbox"/> Permanently flowing stream or river in, or adjacent to, the wetland  <input type="checkbox"/> Seasonally flowing stream in, or adjacent to, the wetland  <input type="checkbox"/> <b>Lake-fringe wetland..... = 2 points</b>  <input type="checkbox"/> <b>Freshwater tidal wetland..... = 2 points</b></p> <p style="text-align: right;"><b>Map of hydroperiods</b></p> <p>4 or more types present points = 3                      3 or more types present..... points = 2                      2 types present..... points = 1                      1 type present ..... points = 0</p>	<p><b>Figure</b> ____</p> <p style="text-align: right;">1</p>
H 1.3	<p><u>Richness of Plant Species</u> (see p. 75):                      Count the number of plant species in the wetland that cover at least 10 ft<sup>2</sup> (different patches of the same species can be combined to meet the size threshold)                      You do not have to name the species. Do not include Eurasian Milfoil, reed canarygrass, purple loosestrife, Canadian Thistle.</p> <p>If you counted: &gt; 19 species ..... points = 2                      5 – 19 species..... points = 1                      &lt; 5 species ..... points = 0</p> <p>List species below if you want to:                      _____                      _____                      _____</p>	<p style="text-align: right;">1</p>
H 1.4	<p><u>Interspersion of Habitats</u> (see p. 76):                      Decided from the diagrams below whether interspersion between Cowardin vegetation (described in H1.1), or the classes and unvegetated areas (can include open water or mudflats) is high, medium, low, or none.</p> <div style="display: flex; justify-content: space-around;"> <div style="text-align: center;">                           None = 0 points                     </div> <div style="text-align: center;">                           Low = 1 point                     </div> <div style="text-align: center;">                           Moderate = 2 points                     </div> </div> <div style="display: flex; justify-content: space-around; margin-top: 20px;"> <div style="text-align: center;">                           High = 3 points                     </div> <div style="text-align: center;">                           High = 3 points                     </div> <div style="text-align: center;">                           [riparian braided channels]                     </div> </div> <div style="margin-top: 20px;"> <p>Note: If you have 4 or more classes or 3 vegetation classes and open water, the rating is always “high”.</p> <p><b>Use map of Cowardin classes.</b></p> </div>	<p><b>Figure</b> ____</p> <p style="text-align: right;">0</p>
H 1.5	<p><u>Special Habitat Features</u> (see p. 77):                      Check the habitat features that are present in the wetland. The number of checks is the number of points you put into the next column.</p> <p><input type="checkbox"/> Large, downed, woody debris within the wetland (&gt; 4 in. diameter and 6 ft. long)  <input type="checkbox"/> Standing snags (diameter at the bottom &gt; 4 inches) in the wetland  <input type="checkbox"/> Undercut banks are present for at least 6.6 ft. (2m) and/or overhanging vegetation extends at least 3.3 ft. (1m) over a stream (or ditch) in, or contiguous with the unit, for at least 33 ft. (10m)  <input type="checkbox"/> Stable steep banks of fine material that might be used by beaver or muskrat for denning (&gt; 30 degree slope) OR signs of recent beaver activity are present (cut shrubs or trees that have not yet turned grey/brown)  <input type="checkbox"/> At least 1/4 acre of thin-stemmed persistent vegetation or woody branches are present in areas that are permanently or seasonally inundated (structures for egg-laying by amphibians)  <input type="checkbox"/> Invasive plants cover less than 25% of the wetland area in each stratum of plants</p> <p><i>NOTE: The 20% stated in early printings of the manual on page 78 is an error.</i></p>	<p style="text-align: right;">0</p>
<p><b>H 1 TOTAL Score</b> – potential for providing habitat</p>		<p>Add the points in the column <span style="color: red;">001238</span></p> <p style="text-align: right;"><b>2</b></p>

H 2	Does the wetland have the <u>opportunity</u> to provide habitat for many species?	(only 1 score per box)
	<p>H 2.1 <u>Buffers</u> (see P. 80):  <i>Choose the description that best represents condition of buffer of wetland unit. The highest scoring criterion that applies to the wetland is to be used in the rating. See text for definition of "undisturbed".</i></p> <p><input type="checkbox"/> 100m (330 ft) of relatively undisturbed vegetated areas, rocky areas, or open water &gt; 95% of circumference. No structures are within the undisturbed part of buffer (relatively undisturbed also means no grazing, no landscaping, no daily human use)..... <b>points = 5</b></p> <p><input type="checkbox"/> 100m (330 ft) of relatively undisturbed vegetated areas, rocky areas, or open water &gt; 50% circumference..... <b>points = 4</b></p> <p><input type="checkbox"/> 50m (170 ft) of relatively undisturbed vegetated areas, rocky areas, or open water &gt; 95% circumference..... <b>points = 4</b></p> <p><input type="checkbox"/> 100m (330 ft) of relatively undisturbed vegetated areas, rocky areas, or open water &gt; 25% circumference..... <b>points = 3</b></p> <p><input type="checkbox"/> 50m (170 ft) of relatively undisturbed vegetated areas, rocky areas, or open water for &gt; 50% circumference..... <b>points = 3</b></p> <p><b>If buffer does not meet any of the criteria above:</b></p> <p><input type="checkbox"/> No paved areas (except paved trails) or buildings within 25m (80 ft) of wetland &gt; 95% circumference. Light to moderate grazing or lawns are OK..... <b>points = 2</b></p> <p><input type="checkbox"/> No paved areas of buildings within 50m of wetland for &gt; 50% circumference. Light to moderate grazing or lawns are OK..... <b>points = 2</b></p> <p><input type="checkbox"/> Heavy grazing in buffer..... <b>points = 1</b></p> <p><input checked="" type="checkbox"/> Vegetated buffers are &lt; 2m wide (6.6 ft) for more than 95% circumference (e.g. tilled fields, paving, basalt bedrock extend to edge of wetland)..... <b>points = 0</b></p> <p><input type="checkbox"/> Buffer does not meet any of the criteria above..... <b>points = 1</b></p> <p style="text-align: right;"><b>Arial photo showing buffers</b></p>	<p>Figure ____</p> <p>0</p>
	<p>H 2.2 <u>Corridors and Connections</u> (see p. 81)</p> <p>H 2.2.1 Is the wetland part of a relatively undisturbed and unbroken vegetated corridor (either riparian or upland) that is at least 150 ft. wide, has at least a 30% cover of shrubs, forest or native undisturbed prairie, that connects to estuaries, other wetlands or undisturbed uplands that are at least 250 acres in size? (<i>Dams in riparian corridors, heavily used gravel roads, paved roads, are considered breaks in the corridor.</i>)</p> <p style="text-align: center;">YES = <b>4 points</b> (go to H 2.3)                      NO = go to H 2.2.2</p> <p>H. 2.2.2 Is the wetland part of a relatively undisturbed and unbroken vegetated corridor (either riparian or upland) that is at least 50 ft. wide, has at least 30% cover of shrubs or forest, and connects to estuaries, other wetlands or undisturbed uplands that are at least 25 acres in size? <b>OR a Lake-fringe</b> wetland, if it does not have an undisturbed corridor as in the question above?</p> <p style="text-align: center;">YES = <b>2 points</b> (go to H 2.3)                      NO = go to H 2.2.3</p> <p>H. 2.2.3 Is the wetland:</p> <ul style="list-style-type: none"> <li>• Within 5 mi (8km) of a brackish or salt water estuary OR</li> <li>• Within 3 miles of a large field or pasture (&gt; 40 acres) OR</li> <li>• <b>Within 1 mile of a lake greater than 20 acres?</b></li> </ul> <p style="text-align: right;">YES = <b>1 point</b> NO = 0 points</p>	<p>1</p>

Comments:

	<p>H 2.3 <u>Near or adjacent to other priority habitats listed by WDFW</u> (see p. 82): (see new and complete descriptions of WDFW priority habitats, and the counties in which they can be found, in the PHS report <a href="http://wdfw.wa.gov/hab/phslist.htm">http://wdfw.wa.gov/hab/phslist.htm</a> )</p> <p>Which of the following priority habitats are within 330 ft. (100m) of the wetland unit?  <i>NOTE: the connections do not have to be relatively undisturbed.</i></p> <p><input type="checkbox"/> <b>Aspen Stands:</b> Pure or mixed stands of aspen greater than 0.4 ha (1 acre).</p> <p><input type="checkbox"/> <b>Biodiversity Areas and Corridors:</b> Areas of habitat that are relatively important to various species of native fish and wildlife (full descriptions in WDFW PHS report p. 152).</p> <p><input type="checkbox"/> <b>Herbaceous Balds:</b> Variable size patches of grass and forbs on shallow soils over bedrock.</p> <p><input type="checkbox"/> <b>Old-growth/Mature forests:</b> (Old-growth west of Cascade crest) Stands of at least 2 tree species, forming a multi-layered canopy with occasional small openings; with at least 20 trees/ha (8 trees/acre) &gt; 81 cm (32 in) dbh or &gt; 200 years of age. (Mature forests) Stands with average diameters exceeding 53 cm (21 in) dbh; crown cover may be less than 100%; decay, decadence, numbers of snags, and quantity of large downed material is generally less than that found in old-growth; 80 - 200 years old west of the Cascade crest.</p> <p><input type="checkbox"/> <b>Oregon white Oak:</b> Woodlands Stands of pure oak or oak/conifer associations where canopy coverage of the oak component is important (full descriptions in WDFW PHS report p. 158).</p> <p><input checked="" type="checkbox"/> <b>Riparian:</b> The area adjacent to aquatic systems with flowing water that contains elements of both aquatic and terrestrial ecosystems which mutually influence each other.</p> <p><input type="checkbox"/> <b>Westside Prairies:</b> Herbaceous, non-forested plant communities that can either take the form of a dry prairie or a wet prairie (full descriptions in WDFW PHS report p. 161).</p> <p><input checked="" type="checkbox"/> <b>Instream:</b> The combination of physical, biological, and chemical processes and conditions that interact to provide functional life history requirements for instream fish and wildlife resources.</p> <p><input type="checkbox"/> <b>Nearshore:</b> Relatively undisturbed nearshore habitats. These include Coastal Nearshore, Open Coast Nearshore, and Puget Sound Nearshore. (full descriptions of habitats and the definition of relatively undisturbed are in WDFW report: pp. 167-169 and glossary in Appendix A).</p> <p><input type="checkbox"/> <b>Caves:</b> A naturally occurring cavity, recess, void, or system of interconnected passages under the earth in soils, rock, ice, or other geological formations and is large enough to contain a human.</p> <p><input type="checkbox"/> <b>Cliffs:</b> Greater than 7.6 m (25 ft) high and occurring below 5000 ft.</p> <p><input type="checkbox"/> <b>Talus:</b> Homogenous areas of rock rubble ranging in average size 0.15 - 2.0 m (0.5 - 6.5 ft), composed of basalt, andesite, and/or sedimentary rock, including riprap slides and mine tailings. May be associated with cliffs.</p> <p><input type="checkbox"/> <b>Snags and Logs:</b> Trees are considered snags if they are dead or dying and exhibit sufficient decay characteristics to enable cavity excavation/use by wildlife. Priority snags have a diameter at breast height of &gt; 51 cm (20 in) in western Washington and are &gt; 2 m (6.5 ft) in height. Priority logs are &gt; 30 cm (12 in) in diameter at the largest end, and &gt; 6 m (20 ft) long.</p> <p>If wetland has <b>3 or more</b> priority habitats = <b>4 points</b>  <b>If wetland has 2</b> priority habitats = <b>3 points</b>                  If wetland has <b>1</b> priority habitat = <b>1 point</b>                      No habitats = 0 points</p> <p>Note: All vegetated wetlands are by definition a priority habitat but are not included in this list. Nearby wetlands are addressed in question H 2.4)</p>	3
	<p>H 2.4 <u>Wetland Landscape:</u> Choose the <b>one</b> description of the landscape around the wetland that best fits (see p. 84)</p> <ul style="list-style-type: none"> <li>• There are at least 3 other wetlands within 1/2 mile, and the connections between them are relatively undisturbed (light grazing between wetlands OK, as is lake shore with some boating, but connections should NOT be bisected by paved roads, fill, fields, or other development.....points = 5</li> <li>• The wetland is Lake-fringe on a lake with little disturbance and there are 3 other lake-fringe wetlands within 1/2 mile .....points = 5</li> <li>• <b>There are at least 3 other wetlands within 1/2 mile, BUT the connections between them are disturbed.....points = 3</b></li> <li>• The wetland fringe on a lake <b>with</b> disturbance and there are 3 other lake-fringe wetlands within 1/2 mile .....points = 3</li> <li>• There is at least 1 wetland within 1/2 mile .....points = 2</li> <li>• There are no wetlands within 1/2 mile.....points = 0</li> </ul>	3
	<p><b>H 2 TOTAL Score</b> – opportunity for providing habitat                      Add the scores from H2.1, H2.2, H2.3, H2.4</p>	7
	<p style="text-align: right;"><i>TOTAL for H 1 from page 8</i></p>	2
◆	<p><b>Total Score for Habitat Functions</b>                      Add the points for H 1 and H 2; then <b>record the result on p. 1</b></p>	9

Comments:

## CATEGORIZATION BASED ON SPECIAL CHARACTERISTICS

*Please determine if the wetland meets the attributes described below  
and circle the appropriate answers and Category.*

<b>Wetland Type</b> – Check off any criteria that apply to the wetland. Circle the Category when the appropriate criteria are met.		
<b>SC1</b>	<p><b>Estuarine wetlands?</b> (see p.86)</p> <p>Does the wetland unit meet the following criteria for Estuarine wetlands?</p> <p><input type="checkbox"/> The dominant water regime is tidal,</p> <p><input type="checkbox"/> Vegetated, and</p> <p><input type="checkbox"/> With a salinity greater than 0.5 ppt.</p> <p style="text-align: center;">YES = Go to SC 1.1                      NO <u>  X  </u></p>	
SC 1.1	<p>Is the wetland unit within a National Wildlife Refuge, National Park, National Estuary Reserve, Natural Area Preserve, State Park or Educational, Environmental, or Scientific Reserve designated under WAC 332-30-151?      YES = Category I                      NO = go to SC 1.2</p>	<b>Cat. I</b>
SC 1.2	<p>Is the wetland at least 1 acre in size and meets at least two of the following conditions?</p> <p style="text-align: center;">YES = Category I                      NO = Category II</p> <p><input type="checkbox"/> The wetland is relatively undisturbed (has no diking, ditching, filling, cultivation, grazing, and has less than 10% cover of non-native plant species. If the non-native <i>Spartina</i> spp., are only species that cover more than 10% of the wetland, then the wetland should be given a dual rating (I/II). The area of <i>Spartina</i> would be rated a Category II while the relatively undisturbed upper marsh with native species would be a Category I. Do not, however, exclude the area of <i>Spartina</i> in determining the size threshold of 1 acre.</p> <p><input type="checkbox"/> At least 3/4 of the landward edge of the wetland has a 100 ft. buffer of shrub, forest, or un-grazed or un-mowed grassland</p> <p><input type="checkbox"/> The wetland has at least 2 of the following features: tidal channels, depressions with open water, or contiguous freshwater wetlands.</p>	<b>Cat. I</b>  <b>Cat. II</b>  <b>Dual Rating I/II</b>
<b>SC2</b>	<p><b>Natural Heritage Wetlands</b> (see p. 87)</p> <p>Natural Heritage wetlands have been identified by the Washington Natural Heritage Program/DNR as either high quality undisturbed wetlands or wetlands that support state Threatened, Endangered, or Sensitive plant species.</p> <p>SC 2.1 Is the wetland being rated in a Section/Township/Range that contains a natural heritage wetland? (<i>This question is used to screen out most sites before you need to contact WNHP/DNR.</i>)</p> <p style="text-align: center;">S/T/R information from Appendix D _____ or accessed from WNHP/DNR web site _____</p> <p style="text-align: center;">YES _____ Contact WNHP/DNR (see p. 79) and go to SC 2.2                      NO <u>  X  </u></p> <p>SC 2.2 Has DNR identified the wetland as a high quality undisturbed wetland or as a site with state threatened or endangered plant species?</p> <p style="text-align: center;">YES = Category 1                      NO _____ not a Heritage Wetland</p>	<b>Cat I</b>
<b>SC3</b>	<p><b>Bogs</b> (see p. 87)</p> <p>Does the wetland (<b>or any part of the unit</b>) meet both the criteria for soils and vegetation in bogs? Use the key below to identify if the wetland is a bog. <i>If you answer yes you will still need to rate the wetland based on its function.</i></p> <ol style="list-style-type: none"> <li>1. Does the unit have organic soil horizons (i.e. layers of organic soil), either peats or mucks, that compose 16 inches or more of the first 32 inches of soil profile? (See Appendix B for a field key to identify organic soils)?      YES = go to question 3      <b>NO = go to question 2</b></li> <li>2. Does the wetland have organic soils, either peats or mucks that are less than 16 inches deep over bedrock, or an impermeable hardpan such as clay or volcanic ash, or that are floating on a lake or pond?      YES = go to question 3      <b>NO = is not a bog for purpose of rating</b></li> <li>3. Does the unit have more than 70% cover of mosses at ground level, AND other plants, if present, consist of the “bog” species listed in Table 3 as a significant component of the vegetation (more than 30% of the total shrub and herbaceous cover consists of species in Table 3)?</li> </ol> <p style="text-align: center;">YES = Is a bog for purpose of rating                      NO = go to question 4</p> <p>NOTE: If you are uncertain about the extent of mosses in the understory you may substitute that criterion by measuring the pH of the water that seeps into a hole dug at least 16” deep. If the pH is less than 5.0 and the “bog” plant species in Table 3 are present, the wetland is a bog.</p> <ol style="list-style-type: none"> <li>4. Is the unit forested (&gt; 30% cover) with sitka spruce, subalpine fir, western red cedar, western hemlock, lodgepole pine, quaking aspen, Englemann’s spruce, or western white pine. WITH any of the species (or combination of species) on the bog species plant list in Table 3 as a significant component of the ground cover (&gt; 30% coverage of the total shrub/herbaceous cover)?</li> </ol> <p style="text-align: center;">YES = Category I                      NO = Is not a bog for purpose of rating</p>	<b>Cat. I</b>

**Exhibit 16**  
**SSDP2016-00415**  
**001241**

<b>SC4</b>	<p><b>Forested Wetlands</b> (<i>see p. 90</i>)</p> <p>Does the wetland have at least 1 acre of forest that meet one of these criteria for the Department of Fish and Wildlife's forests as priority habitats? <i>If you answer yes you will still need to rate the wetland based on its function.</i></p> <p><input type="checkbox"/> <b>Old-growth forests:</b> (west of Cascade Crest) Stands of at least two three species forming a multi-layered canopy with occasional small openings; with at least 8 trees/acre (20 trees/hectare) that are at least 200 years of age OR have a diameter at breast height (dbh) of 32 inches (81 cm or more).</p> <p>NOTE: The criterion for dbh is based on measurements for upland forests. Two-hundred year old trees in wetlands will often have a smaller dbh because their growth rates are often slower. The DFW criterion is and "OR" so old-growth forests do not necessarily have to have trees of this diameter.</p> <p><input type="checkbox"/> <b>Mature forests:</b> (west of the Cascade Crest) Stands where the largest trees are 80 – 200 years old OR have an average diameters (dbh) exceeding 21 inches (53 cm); crown cover may be less than 100%; decay, decadence, numbers of snags, and quantity of large downed material is generally less than that found in old-growth.</p> <p>YES = Category I    NO = <u>X</u> not a forested wetland with special characteristics</p>	<b>Cat. I</b>
<b>SC5</b>	<p><b>Wetlands in Coastal Lagoons</b> (<i>see p. 91</i>)</p> <p>Does the wetland meet all of the following criteria of a wetland in a coastal lagoon?</p> <p><input type="checkbox"/> The wetland lies in a depression adjacent to marine waters that is wholly or partially separated from marine waters by sandbanks, gravel banks, shingle, or, less frequently, rocks.</p> <p><input type="checkbox"/> The lagoon in which the wetland is located contains surface water that is saline or brackish (&gt; 0.5 ppt) during most of the year in at least a portion of the lagoon (<i>needs to be measured near the bottom.</i>)</p> <p>YES = Go to SC 5.1    NO <u>X</u> not a wetland in a coastal lagoon</p> <p>SC 5.1 Does the wetland meet all of the following three conditions?</p> <p><input type="checkbox"/> The wetland is relatively undisturbed (has no diking, ditching, filling, cultivation, grazing) and has less than 20% cover of invasive plant species (see list of invasive species on p. 74).</p> <p><input type="checkbox"/> At least 3/4 of the landward edge of the wetland has a 100 ft. buffer of shrub, forest, or un-grazed or un-mowed grassland.</p> <p><input type="checkbox"/> The wetland is larger than 1/10 acre (4350 square ft.)</p> <p>YES = Category I    NO = Category II</p>	<b>Cat. I</b> <b>Cat. II</b>
<b>SC6</b>	<p><b>Interdunal Wetlands</b> (<i>see p. 93</i>)</p> <p>Is the wetland west of the 1889 line (also called the Western Boundary of Upland Ownership or WBUO)?</p> <p>YES = Go to SC 6.1    NO <u>X</u> not an interdunal wetland for rating</p> <p><b><i>If you answer yes you will still need to rate the wetland based on its functions.</i></b></p> <p>In practical terms that means the following geographic areas:</p> <ul style="list-style-type: none"> <li>• Long Beach Peninsula -- lands west of SR 103</li> <li>• Grayland-Westport -- lands west of SR 105</li> <li>• Ocean Shores-Copalis – lands west of SR 115 and SR 109</li> </ul> <p>SC 6.1 Is the wetland one acre or larger, or is it in a mosaic of wetlands that is one acre or larger?</p> <p>YES = Category II    NO = go to SC 6.2</p> <p>SC 6.2 Is the wetland between 0.1 and 1 acre, or is it in a mosaic of wetlands that is between 0.1 and 1 acre?</p> <p>YES = Category III</p>	<b>Cat. II</b> <b>Cat. III</b>
<b>◆</b>	<p><b>Category of wetland based on Special Characteristics</b></p> <p><i>Choose the "highest" rating if wetland falls into several categories, and record on p. 1.</i></p> <p>If you answered NO for all types enter "Not Applicable" on p. 1</p>	<b>NA</b>

Comments:

**Exhibit 16**  
**SSDP2016-00415**  
**001242**

**WETLAND RATING FORM – WESTERN WASHINGTON**  
Version 2 – Updated July 2006 to increase accuracy and reproducibility among users  
Updated Oct. 2008 with the new WDFW definitions for priority habitats

Name of wetland (if known): 28E Date of site visit: 11-01-13

Rated by: Colin Worsley / Matt Maynard Trained by Ecology? Yes X No      Date of training: 11-2005 / 04-2006

SEC: 29 TOWNSHIP: 25N RANGE: 06E Is S/T/R in Appendix D? Yes      No X

Map of wetland unit: Figure      Estimated size 0.02 acre

**SUMMARY OF RATING**

Category based on FUNCTIONS provided by wetland: I      II      III      IV X

Category I =	Score > 70
Category II =	Score 51 - 69
Category III =	Score 30 – 50
Category IV =	Score < 30

Score for Water Quality Functions	16
Score for Hydrologic Functions	18
Score for Habitat Functions	8
<b>TOTAL Score for Functions</b>	<b>42</b>

Category based on SPECIAL CHARACTERISTICS of Wetland I      II      Does not apply X

**Final Category** (choose the “highest” category from above”) **III**

**Summary of basic information about the wetland unit.**

Wetland Unit has Special Characteristics		Wetland HGM Class used for Rating	
<b>Estuarine</b>		<b>Depressional</b>	<b>X</b>
<b>Natural Heritage Wetland</b>		<b>Riverine</b>	
<b>Bog</b>		<b>Lake-fringe</b>	
<b>Mature Forest</b>		<b>Slope</b>	
<b>Old Growth Forest</b>		<b>Flats</b>	
<b>Coastal Lagoon</b>		<b>Freshwater Tidal</b>	
<b>Interdunal</b>			
None of the above	X	Check if unit has multiple HGM classes present	<span style="border: 1px solid black; padding: 2px;">    </span>

**Does the wetland being rated meet any of the criteria below?** If you answer YES to any of the questions below you will need to protect the wetland according to the regulations regarding the special characteristics found in the wetland.

Check List for Wetlands that Need Additional Protection (in addition to the protection recommended for its category)	YES	NO
SP1. <i>Has the wetland unit been documented as a habitat for any Federally listed Threatened or Endangered <b>animal or plant</b> species (T/E species)?</i> For the purposes of this rating system, “documented” means the wetland is on the appropriate state or federal database.		X
SP2. <i>Has the wetland unit been documented as habitat for any State listed Threatened or Endangered <b>animal</b> species?</i> For the purposes of this rating system, “documented” means the wetland is on the appropriate state database. Note: Wetlands with State listed plant species are categorized as Category 1 Natural Heritage Wetlands (see p. 19 of data form).		X
SP3. <i>Does the wetland unit contain individuals of Priority species listed by the WDFW for the state?</i>		X
SP4. <i>Does the wetland unit have a local significance in addition to its functions?</i> For example, the wetland has been identified in the Shoreline Master Program, the Critical Areas Ordinance, or in a local management plan as having special significance.		X

To complete the next part of the data sheet you will need to determine the Hydrogeomorphic Class of the wetland being rated.

Exhibit 16  
SSDP2016-00415  
001243



### Classification of Vegetated Wetlands for Western Washington

If the hydrologic criteria listed in each question do not apply to the entire unit being rated, you probably have a unit with multiple HGM classes. In this case, identify which hydrologic criteria in questions 1-7 apply, and go to Question 8.

1. Are the water levels in the entire unit usually controlled by tides (i.e. except during floods)?  
NO – go to 2                      **YES – the wetland class is Tidal Fringe**  
 If yes, is the salinity of the water during periods of annual low flow below 0.5 ppt (parts per thousand)?  
**YES – Freshwater Tidal Fringe**                      **NO – Saltwater Tidal Fringe (Estuarine)**  
*If your wetland can be classified as a Freshwater Tidal Fringe use the forms for Riverine wetlands. If it is a Saltwater Tidal Fringe it is rated as an Estuarine wetland. Wetlands that were call estuarine in the first and second editions of the rating system are called Salt Water Tidal Fringe in the Hydrogeomorphic Classification. Estuarine wetlands were categorized separately in the earlier editions, and this separation is being kept in this revision. To maintain consistency between editions, the term “Estuarine” wetland is kept. Please note, however, that the characteristics that define Category I and II estuarine wetlands have changed (see p. \_\_\_\_).*

---

2. The entire wetland unit is flat and precipitation is only source (>90%) of water to it. Groundwater and surface water runoff are NOT sources of water to the unit.  
NO – go to 3                      **YES – The wetland class is Flats**  
 If your wetland can be classified as a “Flats” wetland, use the form for **Depressional** wetlands.

---

3. Does the entire wetland meet both of the following criteria?  
 \_\_\_\_\_ The vegetated part of the wetland is on the shores of a body of permanent open water (without any vegetation on the surface) where at least 20 acres (8ha) in size;  
 \_\_\_\_\_ At least 30% of the open water area is deeper than 6.6 (2 m)?  
NO – go to 4                      **YES – The wetland class is Lake-fringe (Lacustrine Fringe)**

---

4. Does the entire wetland meet all of the following criteria?  
 \_\_\_\_\_ The wetland is on a slope (*slope can be very gradual*).  
 \_\_\_\_\_ The water flows through the wetland in one direction (unidirectional) and usually comes from seeps. It may flow subsurface, as sheetflow, or in a swale without distinct banks.  
 \_\_\_\_\_ The water leaves the wetland **without being impounded**?  
 NOTE: *Surface water does not pond in these types of wetlands except occasionally in very small and shallow depressions or behind hummocks (depressions are usually <3 ft diameter and less than 1 foot deep).*  
NO – go to 5                      **YES – The wetland class is Slope**

---

5. Does the entire wetland meet all of the following criteria?  
 \_\_\_\_\_ The unit is in a valley or stream channel where it gets inundated by overbank flooding from that stream or river.  
 \_\_\_\_\_ The overbank flooding occurs at least once every two years.  
 NOTE: *The riverine unit can contain depressions that are filled with water when the river is not flooding..*  
NO – go to 6                      **YES – The wetland class is Riverine**

---

6. Is the entire wetland unit in a topographic depression in which water ponds, or is saturated to the surface, at some time of the year. This means that any outlet, if present is higher than the interior of the wetland.  
NO – go to 7                      **YES – The wetland class is Depressional**

---

7. Is the entire wetland located in a very flat area with no obvious depression and no overbank flooding. The unit does not pond surface water more than a few inches. The unit seems to be maintained by high groundwater in the area. The wetland may be ditched, but has no obvious natural outlet.  
No – go to 8                      **YES – The wetland class is Depressional**

---

8. Your wetland unit seems to be difficult to classify and probably contains several different HGM classes. For example, seeps at the base of a slope may grade into a riverine floodplain, or a small stream within a depressional wetland has a zone of flooding along its sides. **GO BACK AND IDENTIFY WHICH OF THE HYDROLOGIC REGIMES DESCRIBED IN QUESTIONS 1-7 APPLY TO DIFFERENT AREAS IN THE UNIT** (make a rough sketch to help you decide). Use the following table to identify the appropriate class to use for the rating system if you have several HGM classes present within your wetland. NOTE: Use this table only if the class that is recommended in the second column represents 10% or more of the total area of the wetland unit being rated. If the area of the class listed in column 2 is less than 10% of the unit, classify the wetland using the class that represents more than 90% of the total area.

HGM Classes within the wetland unit being rated	HGM Class to Use in Rating
Slope + Riverine	Riverine
Slope + Depressional	Depressional
Slope + Lake-fringe	Lake-fringe
Depressional + Riverine along stream within boundary	Depressional
Depressional + Lake-fringe	Depressional
Salt Water Tidal Fringe and any other class of freshwater wetland	Treat as ESTUARINE under wetlands with special characteristics

**Exhibit 16**  
**SSDP2016-00415**  
**001244**

If you are unable still to determine which of the above criteria apply to your wetland, or you have more than 2 HGM classes within a wetland boundary, classify the wetland as **Depressional** for the rating.

<b>D Depressional and Flat Wetlands</b>		<b>Points</b>
<b>WATER QUALITY FUNCTIONS – Indicators that wetland functions to improve water quality.</b>		(only 1 score per box) (see p.38)
<b>D 1</b>	<b>Does the wetland have the <u>potential</u> to improve water quality?</b>	
D 1.1	Characteristics of surface water flows out of the wetland: • Unit is a depression with no surface water leaving it (no outlet)..... points = 3 • Unit has an intermittently flowing, OR highly constricted, permanently flowing outlet ..... points = 2 • Unit has an unconstricted, or slightly constricted, surface outlet ( <i>permanently flowing</i> ) ..... points = 1 • Unit is a “flat” depression (Q.7 on key), or in the Flats class, with permanent surface outflow <b>and no obvious natural outlet</b> and/or outlet is a man-made ditch..... points = 1 ( <i>If ditch is not permanently flowing treat unit as “intermittently flowing”</i> ) <b>Provide photo or drawing</b>	Figure ____ 3
D 1.2	The soil 2 inches below the surface (or duff layer) is clay or organic ( <i>use NRCS definitions</i> ) YES points = 4 NO points = 0	0
D 1.3	Characteristics of persistent vegetation (emergent, shrub, and/or forest Cowardin class): • Wetland has persistent, ungrazed vegetation > = 95% of area..... points = 5 • Wetland has persistent, ungrazed vegetation > = 1/2 of area..... points = 3 • Wetland has persistent, ungrazed vegetation > = 1/10 of area..... points = 1 • Wetland has persistent, ungrazed vegetation < 1/10 of area..... points = 0 <b>Map of Cowardin vegetation classes</b>	Figure ____ 5
D 1.4	Characteristics of seasonal ponding or inundation: <i>This is the area of the wetland that is ponded for at least 2 months, but dries out sometime during the year. Do not count the area that is permanently ponded. Estimate area as the average condition 5 out of 10 years.</i> • Area seasonally ponded is > 1/2 total area of wetland ..... points = 4 • Area seasonally ponded is > 1/4 total area of wetland ..... points = 2 • Area seasonally ponded is < 1/4 total area of wetland ..... points = 0 <b>Map of Hydroperiods</b>	Figure ____ 0
<b>Total for D 1</b>		<i>Add the points in the boxes above</i> <b>8</b>
<b>D 2</b>	<b>Does the wetland have the <u>opportunity</u> to improve water quality?</b>	(see p. 44)
Answer YES if you know or believe there are pollutants in groundwater or surface water coming into the wetland that would otherwise reduce water quality in streams, lakes or groundwater downgradient from the wetland? <i>Note which of the following conditions provide the sources of pollutants. A unit may have pollutants coming from several sources, but any single source would qualify as opportunity.</i> ___ Grazing in the wetland or within 150 ft ___ Untreated stormwater discharges to wetland ___ Tilled fields or orchards within 150 ft. of wetland ___ A stream or culvert discharges into wetland that drains developed areas, residential areas, farmed fields, roads, or clear-cut logging <u>X</u> Residential, urban areas, golf courses are within 150 ft. of wetland ___ Wetland is fed by groundwater high in phosphorus or nitrogen ___ Other _____ YES multiplier is 2 NO multiplier is 1		Multiplier <u>X2</u>
<b>◆ TOTAL – Water Quality Functions</b> Multiply the score from D1 by D2; then <i>add score to table on p. 1</i>		16
<b>HYDROLOGIC FUNCTIONS – Indicators that wetland unit functions to reduce flooding and stream degradation.</b>		(see p.46)
<b>D 3</b>	<b>Does the wetland have the <u>potential</u> to reduce flooding and erosion?</b>	
D 3.1	Characteristics of surface water flows out of the wetland unit • Unit is a depression with no surface water leaving it (no outlet)..... points = 4 • Unit has an intermittently flowing, OR highly constricted permanently flowing outlet ..... points = 2 • Unit is a “flat” depression (Q.7 on key) or in the Flats class, with permanent surface outflow <b>and no obvious natural outlet</b> and/or outlet is a man-made ditch..... points = 1 ( <i>If ditch is not permanently flowing treat unit as “intermittently flowing”</i> ) • Unit has an unconstricted, or slightly constricted, surface outlet ( <i>permanently flowing</i> ) ..... points = 0	4
D 3.2	Depth of storage during wet periods. <i>Estimate the height of ponding above the bottom of the outlet. For units with no outlet measure from the surface of permanent water or deepest part (if dry).</i> • Marks of ponding are 3 ft. or more above the surface or bottom of the outlet ..... points = 7 • The wetland is a “headwater” wetland..... points = 5 • Marks of ponding between 2 ft. to < 3 ft. from surface or bottom of outlet ..... points = 5 • Marks are at least 0.5 ft. to < 2 ft. from surface or bottom of outlet ..... points = 3 • Wetland is flat (yes to Q.2 or Q.7 on key)but has small depressions on the surface that trap water points = 1 • Marks of ponding less than 0.5 ft ..... points = 0	0
D 3.3	Contribution of wetland unit to storage in the watershed: <i>Estimate the ratio of the area of upstream basin contributing surface water to the wetland to the area of the wetland unit itself.</i> • The area of the basin is less than 10 times the area of unit..... points = 5 • The area of the basin is 10 to 100 times the area of the unit ..... points = 3 • The area of the basin is more than 100 times the area of the unit ..... points = 0 • Entire unit is in the FLATS class ..... points = 5	5
<b>Total for D 3</b>		<i>Add the points in the boxes above</i> <b>9</b>

<b>D 4</b>	<p><b>Does the wetland have the <u>opportunity</u> to reduce flooding and erosion?</b></p> <p>Answer YES if the unit is in a location in the watershed where the flood storage, or reduction in water velocity, it provides helps protect downstream property and aquatic resources from flooding or excessive and/or erosive flows. Answer NO if the water coming into the wetland is controlled by a structure such as flood gate, tide gate, flap valve, reservoir etc. OR you estimate that more than 90% of the water in the wetland is from groundwater in areas where damaging groundwater flooding does not occur. <i>Note which of the following indicators of opportunity apply.</i></p> <p><input type="checkbox"/> Wetland is in a headwater of a river or stream that has flooding problems.</p> <p><input type="checkbox"/> Wetland drains to a river or stream that has flooding problems</p> <p><input type="checkbox"/> Wetland has no outlet and impounds surface runoff water that might otherwise flow into a river or stream that has flooding problems</p> <p><input type="checkbox"/> Other _____</p> <p><b>YES multiplier is 2</b>                      NO multiplier is 1</p>	<p>(see p. 49)</p> <p>Multiplier</p> <p><u>X2</u></p>
◆	<p><b>TOTAL – Hydrologic Functions</b>                      Multiply the score from D3 by D4; then <i>add score to table on p. 1</i></p>	<p>18</p>

Comments:







<p><i>These questions apply to wetlands of all HGM classes.</i></p> <p>HABITAT FUNCTIONS – Indicators that wetland functions to provide important habitat.</p>		<p><b>Points</b> (only 1 score per box)</p>
<b>H 1</b>	<b>Does the wetland have the <u>potential</u> to provide habitat for many species?</b>	
H 1.1	<p><u>Vegetation structure</u> (see P. 72): Check the types of vegetation classes present (as defined by Cowardin) – Size threshold for each class is 1/4 acre or more than 10% of the area if unit is smaller than 2.5 acres.</p> <p><input type="checkbox"/> Aquatic Bed <input checked="" type="checkbox"/> Emergent plants <input type="checkbox"/> Scrub/shrub (areas where shrubs have &gt; 30% cover) <input type="checkbox"/> Forested (areas where trees have &gt; 30% cover)</p> <p>If the unit has a forested class check if: <input type="checkbox"/> The forested class has 3 out of 5 strata (canopy, sub-canopy, shrubs, herbaceous, moss/ground-cover) that each cover 20% within the forested polygon. Add the number of vegetation types that qualify. If you have:</p> <p>4 structures or more ..... points = 4 3 structures ..... points = 2 1 structure ..... points = 0</p> <p><b>Map of Cowardin vegetation classes</b></p>	<p><b>Figure</b> ____</p> <p>0</p>
H 1.2	<p><u>Hydroperiods</u> (see p.73): Check the types of water regimes (hydroperiods) present within the wetland. The water regime has to cover more than 10% of the wetland or 1/4 acre to count (see text for descriptions of hydroperiods).</p> <p><input type="checkbox"/> Permanently flooded or inundated <input type="checkbox"/> Seasonally flooded or inundated <input type="checkbox"/> Occasionally flooded or inundated <input checked="" type="checkbox"/> Saturated only</p> <p>4 or more types present points = 3 3 or more types present ..... points = 2 2 types present ..... points = 1 1 type present ..... points = 0</p> <p><input type="checkbox"/> Permanently flowing stream or river in, or adjacent to, the wetland <input type="checkbox"/> Seasonally flowing stream in, or adjacent to, the wetland <input type="checkbox"/> <b>Lake-fringe wetland..... = 2 points</b> <input type="checkbox"/> <b>Freshwater tidal wetland..... = 2 points</b></p> <p><b>Map of hydroperiods</b></p>	<p><b>Figure</b> ____</p> <p>0</p>
H 1.3	<p><u>Richness of Plant Species</u> (see p. 75): Count the number of plant species in the wetland that cover at least 10 ft<sup>2</sup> (different patches of the same species can be combined to meet the size threshold) You do not have to name the species. Do not include Eurasian Milfoil, reed canarygrass, purple loosestrife, Canadian Thistle.</p> <p>If you counted: &gt; 19 species ..... points = 2 5 – 19 species ..... points = 1 &lt; 5 species ..... points = 0</p> <p>List species below if you want to: _____ _____ _____</p>	<p>0</p>
H 1.4	<p><u>Interspersion of Habitats</u> (see p. 76): Decided from the diagrams below whether interspersion between Cowardin vegetation (described in H1.1), or the classes and unvegetated areas (can include open water or mudflats) is high, medium, low, or none.</p> <div style="display: flex; justify-content: space-around;"> <div style="text-align: center;">  <p>None = 0 points</p> </div> <div style="text-align: center;">  <p>Low = 1 point</p> </div> <div style="text-align: center;">  <p>Moderate = 2 points</p> </div> <div style="text-align: center;">  </div> </div> <div style="display: flex; justify-content: space-around; margin-top: 20px;"> <div style="text-align: center;">  </div> <div style="text-align: center;">  <p>High = 3 points</p> </div> <div style="text-align: center;">  <p>[riparian braided channels]</p> </div> </div> <p>Note: If you have 4 or more classes or 3 vegetation classes and open water, the rating is always “high”.</p> <p><b>Use map of Cowardin classes.</b></p>	<p><b>Figure</b> ____</p> <p>0</p>
H 1.5	<p><u>Special Habitat Features</u> (see p. 77): Check the habitat features that are present in the wetland. The number of checks is the number of points you put into the next column.</p> <p><input type="checkbox"/> Large, downed, woody debris within the wetland (&gt; 4 in. diameter and 6 ft. long) <input type="checkbox"/> Standing snags (diameter at the bottom &gt; 4 inches) in the wetland <input type="checkbox"/> Undercut banks are present for at least 6.6 ft. (2m) and/or overhanging vegetation extends at least 3.3 ft. (1m) over a stream (or ditch) in, or contiguous with the unit, for at least 33 ft. (10m) <input type="checkbox"/> Stable steep banks of fine material that might be used by beaver or muskrat for denning (&gt; 30 degree slope) OR signs of recent beaver activity are present (cut shrubs or trees that have not yet turned grey/brown) <input type="checkbox"/> At least 1/4 acre of thin-stemmed persistent vegetation or woody branches are present in areas that are permanently or seasonally inundated (structures for egg-laying by amphibians) <input type="checkbox"/> Invasive plants cover less than 25% of the wetland area in each stratum of plants</p> <p>NOTE: The 20% stated in early printings of the manual on page 78 is an error.</p>	<p>0</p>
<b>H 1 TOTAL Score – potential for providing habitat</b>		<p>Add the points in the column.</p> <p><b>001247</b></p> <p>0</p>

Exhibit 16  
SSDP2016-00415  
001247

H 2	Does the wetland have the <u>opportunity</u> to provide habitat for many species?	(only 1 score per box)
	<p>H 2.1 <b>Buffers</b> (see P. 80):  <i>Choose the description that best represents condition of buffer of wetland unit. The highest scoring criterion that applies to the wetland is to be used in the rating. See text for definition of "undisturbed".</i></p> <p><input type="checkbox"/> 100m (330 ft) of relatively undisturbed vegetated areas, rocky areas, or open water &gt; 95% of circumference. No structures are within the undisturbed part of buffer (relatively undisturbed also means no grazing, no landscaping, no daily human use)..... <b>points = 5</b></p> <p><input type="checkbox"/> 100m (330 ft) of relatively undisturbed vegetated areas, rocky areas, or open water &gt; 50% circumference..... <b>points = 4</b></p> <p><input type="checkbox"/> 50m (170 ft) of relatively undisturbed vegetated areas, rocky areas, or open water &gt; 95% circumference..... <b>points = 4</b></p> <p><input type="checkbox"/> 100m (330 ft) of relatively undisturbed vegetated areas, rocky areas, or open water &gt; 25% circumference..... <b>points = 3</b></p> <p><input type="checkbox"/> 50m (170 ft) of relatively undisturbed vegetated areas, rocky areas, or open water for &gt; 50% circumference..... <b>points = 3</b></p> <p><b>If buffer does not meet any of the criteria above:</b></p> <p><input type="checkbox"/> No paved areas (except paved trails) or buildings within 25m (80 ft) of wetland &gt; 95% circumference. Light to moderate grazing or lawns are OK..... <b>points = 2</b></p> <p><input type="checkbox"/> No paved areas of buildings within 50m of wetland for &gt; 50% circumference. Light to moderate grazing or lawns are OK..... <b>points = 2</b></p> <p><input type="checkbox"/> Heavy grazing in buffer..... <b>points = 1</b></p> <p><input type="checkbox"/> Vegetated buffers are &lt; 2m wide (6.6 ft) for more than 95% circumference (e.g. tilled fields, paving, basalt bedrock extend to edge of wetland)..... <b>points = 0</b></p> <p><input checked="" type="checkbox"/> Buffer does not meet any of the criteria above..... <b>points = 1</b></p> <p style="text-align: right;"><b>Arial photo showing buffers</b></p>	<p><b>Figure</b> ____</p> <p style="text-align: center;">1</p>
	<p>H 2.2 <b>Corridors and Connections</b> (see p. 81)</p> <p>H 2.2.1 Is the wetland part of a relatively undisturbed and unbroken vegetated corridor (either riparian or upland) that is at least 150 ft. wide, has at least a 30% cover of shrubs, forest or native undisturbed prairie, that connects to estuaries, other wetlands or undisturbed uplands that are at least 250 acres in size? (<i>Dams in riparian corridors, heavily used gravel roads, paved roads, are considered breaks in the corridor.</i>)                      YES = <b>4 points</b> (go to H 2.3) <span style="background-color: yellow;">NO = go to H 2.2.2</span></p> <p>H. 2.2.2 Is the wetland part of a relatively undisturbed and unbroken vegetated corridor (either riparian or upland) that is at least 50 ft. wide, has at least 30% cover of shrubs or forest, and connects to estuaries, other wetlands or undisturbed uplands that are at least 25 acres in size? <b>OR a Lake-fringe</b> wetland, if it does not have an undisturbed corridor as in the question above?                      YES = <b>2 points</b> (go to H 2.3) <span style="background-color: yellow;">NO = go to H 2.2.3</span></p> <p>H. 2.2.3 Is the wetland:  <ul style="list-style-type: none"> <li>• Within 5 mi (8km) of a brackish or salt water estuary OR</li> <li>• Within 3 miles of a large field or pasture (&gt; 40 acres) OR <span style="background-color: yellow;">YES = 1 point</span></li> <li>• <span style="background-color: yellow;">Within 1 mile of a lake greater than 20 acres?</span> <span style="background-color: yellow;">NO = 0 points</span></li> </ul> </p>	<p style="text-align: center;">1</p>

Comments:

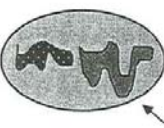
	<p>H 2.3 <u>Near or adjacent to other priority habitats listed by WDFW</u> (see p. 82): (see new and complete descriptions of WDFW priority habitats, and the counties in which they can be found, in the PHS report <a href="http://wdfw.wa.gov/hab/phslist.htm">http://wdfw.wa.gov/hab/phslist.htm</a>)</p> <p>Which of the following priority habitats are within 330 ft. (100m) of the wetland unit?  <i>NOTE: the connections do not have to be relatively undisturbed.</i></p> <p><input type="checkbox"/> <b>Aspen Stands:</b> Pure or mixed stands of aspen greater than 0.4 ha (1 acre).</p> <p><input type="checkbox"/> <b>Biodiversity Areas and Corridors:</b> Areas of habitat that are relatively important to various species of native fish and wildlife (full descriptions in WDFW PHS report p. 152).</p> <p><input type="checkbox"/> <b>Herbaceous Balds:</b> Variable size patches of grass and forbs on shallow soils over bedrock.</p> <p><input type="checkbox"/> <b>Old-growth/Mature forests:</b> (Old-growth west of Cascade crest) Stands of at least 2 tree species, forming a multi-layered canopy with occasional small openings; with at least 20 trees/ha (8 trees/acre) &gt; 81 cm (32 in) dbh or &gt; 200 years of age. (Mature forests) Stands with average diameters exceeding 53 cm (21 in) dbh; crown cover may be less than 100%; decay, decadence, numbers of snags, and quantity of large downed material is generally less than that found in old-growth; 80 - 200 years old west of the Cascade crest.</p> <p><input type="checkbox"/> <b>Oregon white Oak:</b> Woodlands Stands of pure oak or oak/conifer associations where canopy coverage of the oak component is important (full descriptions in WDFW PHS report p. 158).</p> <p><input checked="" type="checkbox"/> <b>Riparian:</b> The area adjacent to aquatic systems with flowing water that contains elements of both aquatic and terrestrial ecosystems which mutually influence each other.</p> <p><input type="checkbox"/> <b>Westside Prairies:</b> Herbaceous, non-forested plant communities that can either take the form of a dry prairie or a wet prairie (full descriptions in WDFW PHS report p. 161).</p> <p><input checked="" type="checkbox"/> <b>Instream:</b> The combination of physical, biological, and chemical processes and conditions that interact to provide functional life history requirements for instream fish and wildlife resources.</p> <p><input type="checkbox"/> <b>Nearshore:</b> Relatively undisturbed nearshore habitats. These include Coastal Nearshore, Open Coast Nearshore, and Puget Sound Nearshore. (full descriptions of habitats and the definition of relatively undisturbed are in WDFW report: pp. 167-169 and glossary in Appendix A).</p> <p><input type="checkbox"/> <b>Caves:</b> A naturally occurring cavity, recess, void, or system of interconnected passages under the earth in soils, rock, ice, or other geological formations and is large enough to contain a human.</p> <p><input type="checkbox"/> <b>Cliffs:</b> Greater than 7.6 m (25 ft) high and occurring below 5000 ft.</p> <p><input type="checkbox"/> <b>Talus:</b> Homogenous areas of rock rubble ranging in average size 0.15 - 2.0 m (0.5 - 6.5 ft), composed of basalt, andesite, and/or sedimentary rock, including riprap slides and mine tailings. May be associated with cliffs.</p> <p><input type="checkbox"/> <b>Snags and Logs:</b> Trees are considered snags if they are dead or dying and exhibit sufficient decay characteristics to enable cavity excavation/use by wildlife. Priority snags have a diameter at breast height of &gt; 51 cm (20 in) in western Washington and are &gt; 2 m (6.5 ft) in height. Priority logs are &gt; 30 cm (12 in) in diameter at the largest end, and &gt; 6 m (20 ft) long.</p> <p>If wetland has <b>3 or more</b> priority habitats = <b>4 points</b>  <b>If wetland has 2</b> priority habitats = <b>3 points</b>                  If wetland has <b>1</b> priority habitat = <b>1 point</b>                      No habitats = 0 points</p> <p>Note: All vegetated wetlands are by definition a priority habitat but are not included in this list. Nearby wetlands are addressed in question H 2.4)</p>	3
	<p>H 2.4 <u>Wetland Landscape:</u> Choose the <b>one</b> description of the landscape around the wetland that best fits (see p. 84)</p> <ul style="list-style-type: none"> <li>• There are at least 3 other wetlands within 1/2 mile, and the connections between them are relatively undisturbed (light grazing between wetlands OK, as is lake shore with some boating, but connections should NOT be bisected by paved roads, fill, fields, or other development.....points = 5</li> <li>• The wetland is Lake-fringe on a lake with little disturbance and there are 3 other lake-fringe wetlands within 1/2 mile .....points = 5</li> <li>• <b>There are at least 3 other wetlands within 1/2 mile, BUT the connections between them are disturbed.....points = 3</b></li> <li>• The wetland fringe on a lake <b>with</b> disturbance and there are 3 other lake-fringe wetlands within 1/2 mile .....points = 3</li> <li>• There is at least 1 wetland within 1/2 mile .....points = 2</li> <li>• There are no wetlands within 1/2 mile.....points = 0</li> </ul>	3
	<p><b>H 2 TOTAL Score</b> – opportunity for providing habitat                      Add the scores from H2.1, H2.2, H2.3, H2.4</p>	8
	<p style="text-align: right;"><i>TOTAL for H 1 from page 8</i></p>	0
◆	<p><b>Total Score for Habitat Functions</b>                      Add the points for H 1 and H 2; then <b>record the result on p. 1</b></p>	8

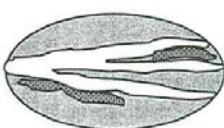
Comments:



<p><b>SC4</b></p>	<p><b>Forested Wetlands</b> (see p. 90)                  Does the wetland have at least 1 acre of forest that meet one of these criteria for the Department of Fish and Wildlife's forests as priority habitats? <i>If you answer yes you will still need to rate the wetland based on its function.</i>                  ___ <b>Old-growth forests:</b> (west of Cascade Crest) Stands of at least two three species forming a multi-layered canopy with occasional small openings; with at least 8 trees/acre (20 trees/hectare) that are at least 200 years of age OR have a diameter at breast height (dbh) of 32 inches (81 cm or more).                  NOTE: The criterion for dbh is based on measurements for upland forests. Two-hundred year old trees in wetlands will often have a smaller dbh because their growth rates are often slower. The DFW criterion is and "OR" so old-growth forests do not necessarily have to have trees of this diameter.                  ___ <b>Mature forests:</b> (west of the Cascade Crest) Stands where the largest trees are 80 – 200 years old OR have an average diameters (dbh) exceeding 21 inches (53 cm); crown cover may be less than 100%; decay, decadence, numbers of snags, and quantity of large downed material is generally less than that found in old-growth.                  YES = Category I                                      NO = <u>X</u> not a forested wetland with special characteristics</p>	<p><b>Cat. I</b></p>
<p><b>SC5</b></p>	<p><b>Wetlands in Coastal Lagoons</b> (see p. 91)                  Does the wetland meet all of the following criteria of a wetland in a coastal lagoon?                  ___ The wetland lies in a depression adjacent to marine waters that is wholly or partially separated from marine waters by sandbanks, gravel banks, shingle, or, less frequently, rocks.                  ___ The lagoon in which the wetland is located contains surface water that is saline or brackish (&gt; 0.5 ppt) during most of the year in at least a portion of the lagoon (<i>needs to be measured near the bottom.</i>)                  YES = Go to SC 5.1                                      NO <u>X</u> not a wetland in a coastal lagoon                  SC 5.1 Does the wetland meet all of the following three conditions?                  ___ The wetland is relatively undisturbed (has no diking, ditching, filling, cultivation, grazing) and has less than 20% cover of invasive plant species (see list of invasive species on p. 74).                  ___ At least 3/4 of the landward edge of the wetland has a 100 ft. buffer of shrub, forest, or un-grazed or un-mowed grassland.                  ___ The wetland is larger than 1/10 acre (4350 square ft.)                  YES = Category I                                      NO = Category II</p>	<p><b>Cat. I</b>          <b>Cat. II</b></p>
<p><b>SC6</b></p>	<p><b>Interdunal Wetlands</b> (see p. 93)                  Is the wetland west of the 1889 line (also called the Western Boundary of Upland Ownership or WBUO)?                  YES = Go to SC 6.1                                      NO <u>X</u> not an interdunal wetland for rating  <i>If you answer yes you will still need to rate the wetland based on its functions.</i>                  In practical terms that means the following geographic areas:                  • Long Beach Peninsula -- lands west of SR 103                  • Grayland-Westport -- lands west of SR 105                  • Ocean Shores-Copalis – lands west of SR 115 and SR 109                  SC 6.1 Is the wetland one acre or larger, or is it in a mosaic of wetlands that is one acre or larger?                  YES = Category II                                      NO = go to SC 6.2                  SC 6.2 Is the wetland between 0.1 and 1 acre, or is it in a mosaic of wetlands that is between 0.1 and 1 acre?                  YES = Category III</p>	<p><b>Cat. II</b>       <b>Cat. III</b></p>
<p>◆</p>	<p><b>Category of wetland based on Special Characteristics</b>                  Choose the "highest" rating if wetland falls into several categories, and record on p. 1.                  If you answered NO for all types enter "Not Applicable" on p. 1</p>	<p><b>NA</b></p>

**Comments:**



Wetland name or number 29B

**WETLAND RATING FORM – WESTERN WASHINGTON**  
Version 2 – Updated July 2006 to increase accuracy and reproducibility among users  
Updated Oct. 2008 with the new WDFW definitions for priority habitats

Name of wetland (if known): 29B Date of site visit: 03-20-14

Rated by: Colin Worsley / Matt Maynard Trained by Ecology? Yes X No      Date of training: 11-2005 / 04-2006

SEC: 29 TOWNSHIP: 25N RANGE: 06E Is S/T/R in Appendix D? Yes      No X

Map of wetland unit: Figure      Estimated size 0.02 acre

**SUMMARY OF RATING**

Category based on FUNCTIONS provided by wetland: I      II      III      IV X

Category I =	Score > 70
Category II =	Score 51 - 69
Category III =	Score 30 – 50
Category IV =	Score < 30

Score for Water Quality Functions	2
Score for Hydrologic Functions	0
Score for Habitat Functions	5
<b>TOTAL Score for Functions</b>	<b>7</b>

Category based on SPECIAL CHARACTERISTICS of Wetland I      II      Does not apply X

**Final Category** (choose the “highest” category from above”)

**IV**

**Summary of basic information about the wetland unit.**

Wetland Unit has Special Characteristics		Wetland HGM Class used for Rating	
<b>Estuarine</b>		<b>Depressional</b>	
<b>Natural Heritage Wetland</b>		<b>Riverine</b>	
<b>Bog</b>		<b>Lake-fringe</b>	
<b>Mature Forest</b>		<b>Slope</b>	<b>X</b>
<b>Old Growth Forest</b>		<b>Flats</b>	
<b>Coastal Lagoon</b>		<b>Freshwater Tidal</b>	
<b>Interdunal</b>			
None of the above	X	Check if unit has multiple HGM classes present	

**Does the wetland being rated meet any of the criteria below?** If you answer YES to any of the questions below you will need to protect the wetland according to the regulations regarding the special characteristics found in the wetland.

Check List for Wetlands that Need Additional Protection (in addition to the protection recommended for its category)	YES	NO
SP1. <i>Has the wetland unit been documented as a habitat for any Federally listed Threatened or Endangered <b>animal or plant</b> species (T/E species)?</i> For the purposes of this rating system, “documented” means the wetland is on the appropriate state or federal database.		X
SP2. <i>Has the wetland unit been documented as habitat for any State listed Threatened or Endangered <b>animal</b> species?</i> For the purposes of this rating system, “documented” means the wetland is on the appropriate state database. Note: Wetlands with State listed plant species are categorized as Category 1 Natural Heritage Wetlands (see p. 19 of data form).		X
SP3. <i>Does the wetland unit contain individuals of Priority species listed by the WDFW for the state?</i>		X
SP4. <i>Does the wetland unit have a local significance in addition to its functions?</i> For example, the wetland has been identified in the Shoreline Master Program, the Critical Areas Ordinance, or in a local management plan as having special significance.		X

To complete the next part of the data sheet you will need to determine the Hydrogeomorphic Class of the wetland being rated.

Exhibit 16  
SSDP2016-00415  
001292

**Classification of Vegetated Wetlands for Western Washington**

If the hydrologic criteria listed in each question do not apply to the entire unit being rated, you probably have a unit with multiple HGM classes. In this case, identify which hydrologic criteria in questions 1-7 apply, and go to Question 8.

1. Are the water levels in the entire unit usually controlled by tides (i.e. except during floods)?  
**NO – go to 2**                      YES – the wetland class is **Tidal Fringe**  
 If yes, is the salinity of the water during periods of annual low flow below 0.5 ppt (parts per thousand)?  
**YES – Freshwater Tidal Fringe**                      **NO – Saltwater Tidal Fringe (Estuarine)**  
*If your wetland can be classified as a Freshwater Tidal Fringe use the forms for Riverine wetlands. If it is a Saltwater Tidal Fringe it is rated as an Estuarine wetland. Wetlands that were call estuarine in the first and second editions of the rating system are called Salt Water Tidal Fringe in the Hydrogeomorphic Classification. Estuarine wetlands were categorized separately in the earlier editions, and this separation is being kept in this revision. To maintain consistency between editions, the term “Estuarine” wetland is kept. Please note, however, that the characteristics that define Category I and II estuarine wetlands have changed (see p. \_\_\_\_\_).*

---

2. The entire wetland unit is flat and precipitation is only source (>90%) of water to it. Groundwater and surface water runoff are NOT sources of water to the unit.  
**NO – go to 3**                      YES – The wetland class is **Flats**  
 If your wetland can be classified as a “Flats” wetland, use the form for **Depressional** wetlands.

---

3. Does the entire wetland meet both of the following criteria?  
 \_\_\_\_\_ The vegetated part of the wetland is on the shores of a body of permanent open water (without any vegetation on the surface) where at least 20 acres (8ha) in size;  
 \_\_\_\_\_ At least 30% of the open water area is deeper than 6.6 (2 m)?  
**NO – go to 4**                      YES – The wetland class is **Lake-fringe (Lacustrine Fringe)**

---

4. Does the entire wetland meet all of the following criteria?  
 The wetland is on a slope (*slope can be very gradual*).  
 The water flows through the wetland in one direction (unidirectional) and usually comes from seeps. It may flow subsurface, as sheetflow, or in a swale without distinct banks.  
 The water leaves the wetland **without being impounded?**  
 NOTE: *Surface water does not pond in these types of wetlands except occasionally in very small and shallow depressions or behind hummocks (depressions are usually <3 ft diameter and less than 1 foot deep).*  
**NO – go to 5**                      **YES – The wetland class is Slope**

---

5. Does the entire wetland meet all of the following criteria?  
 \_\_\_\_\_ The unit is in a valley or stream channel where it gets inundated by overbank flooding from that stream or river.  
 \_\_\_\_\_ The overbank flooding occurs at least once every two years.  
 NOTE: *The riverine unit can contain depressions that are filled with water when the river is not flooding..*  
**NO – go to 6**                      YES – The wetland class is **Riverine**

---

6. Is the entire wetland unit in a topographic depression in which water ponds, or is saturated to the surface, at some time of the year. This means that any outlet, if present is higher than the interior of the wetland.  
**NO – go to 7**                      YES – The wetland class is **Depressional**

---

7. Is the entire wetland located in a very flat area with no obvious depression and no overbank flooding. The unit does not pond surface water more than a few inches. The unit seems to be maintained by high groundwater in the area. The wetland may be ditched, but has no obvious natural outlet.  
**No – go to 8**                      YES – The wetland class is **Depressional**

---

8. Your wetland unit seems to be difficult to classify and probably contains several different HGM classes. For example, seeps at the base of a slope may grade into a riverine floodplain, or a small stream within a depressional wetland has a zone of flooding along its sides. GO BACK AND IDENTIFY WHICH OF THE HYDROLOGIC REGIMES DESCRIBED IN QUESTIONS 1-7 APPLY TO DIFFERENT AREAS IN THE UNIT (make a rough sketch to help you decide). Use the following table to identify the appropriate class to use for the rating system if you have several HGM classes present within your wetland. NOTE: Use this table only if the class that is recommended in the second column represents 10% or more of the total area of the wetland unit being rated. If the area of the class listed in column 2 is less than 10% of the unit, classify the wetland using the class that represents more than 90% of the total area.

HGM Classes within the wetland unit being rated	HGM Class to Use in Rating
Slope + Riverine	Riverine
Slope + Depressional	Depressional
Slope + Lake-fringe	Lake-fringe
Depressional + Riverine along stream within boundary	Depressional
Depressional + Lake-fringe	Depressional
Salt Water Tidal Fringe and any other class of freshwater wetland	Treat as ESTUARINE under wetlands with special characteristics

**Exhibit 16**  
**SSDP2016-00415**  
**001253**

If you are unable still to determine which of the above criteria apply to your wetland, or you have more than 2 HGM classes within a wetland boundary, classify the wetland as **Depressional** for the rating.

S Slope Wetlands		Points
WATER QUALITY FUNCTIONS – Indicators that wetland functions to improve water quality.		(only 1 score per box) (see p.64)
<b>S 1</b>	<b>Does the wetland have the potential to improve water quality?</b>	
S 1.1	Characteristics of average slope of unit: <ul style="list-style-type: none"> <li>Slope is 1% or less (a 1% slope has a 1 ft. vertical drop in elevation for every 100 ft. horizontal distance)..... points = 3</li> <li>Slope is 1% - 2% ..... points = 2</li> <li>Slope is 2% - 5% ..... points = 1</li> <li>Slope is greater than 5% ..... points = 0</li> </ul>	1
S 1.2	The soil 2 inches below the surface (or duff layer) is clay, organic (Use NRCS definitions). YES = 3 points                      NO = 0 points	0
S 1.3	Characteristics of the vegetation in the wetland that trap sediments and pollutants: Choose the points appropriate for the description that best fits the vegetation in the wetland. Dense vegetation means you have trouble seeing the soil surface (>75% cover), and uncut means not grazed or mowed and plants are higher than 6 inches. <ul style="list-style-type: none"> <li>Dense, uncut, herbaceous vegetation &gt; 90% of the wetland area..... points = 6</li> <li>Dense, uncut, herbaceous vegetation &gt; 1/2 of area ..... points = 3</li> <li>Dense, woody, vegetation &gt; 1/2 of area..... points = 2</li> <li>Dense, uncut, herbaceous vegetation &gt; 1/4 of area ..... points = 1</li> <li>Does not meet any of the criteria above for vegetation ..... points = 0</li> </ul> Aerial photo or map with vegetation polygons	Figure ____  0
<b>Total for S 1</b> Add the points in the boxes above		<b>2</b>
<b>S 2</b>	<b>Does the wetland have the opportunity to improve water quality?</b> Answer YES if you know or believe there are pollutants in groundwater or surface water coming into the wetland that would otherwise reduce water quality in streams, lakes or groundwater downgradient from the wetland? Note which of the following conditions provide the sources of pollutants. A unit may have pollutants coming from several sources, but any single source would qualify as opportunity. _____ Grazing in the wetland or within 150 ft _____ Untreated stormwater discharges to wetland _____ Tilled fields, logging, or orchards within 150 ft. of wetland <u> X </u> Residential, urban areas, or golf courses are within 150 ft. upslope of wetland _____ Other _____ YES multiplier is 2                      NO multiplier is 1	(see p. 67)  Multiplier  <u> X2 </u>
<b>◆ TOTAL – Water Quality Functions</b> Multiply the score from S1 by S2; then add score to table on p. 1		<b>2</b>
HYDROLOGIC FUNCTIONS – Indicators that wetland functions to reduce flooding and stream erosion.		
<b>S 3</b>	<b>Does the wetland have the potential to reduce flooding and stream erosion?</b>	(see p.68)
S 3.1	Characteristics of vegetation that reduce the velocity of surface flows during storms: Choose the points appropriate for the description that best fits conditions in the wetland (stems of plants should be thick enough (usually > 1/8in), or dense enough to remain erect during surface flows). <ul style="list-style-type: none"> <li>Dense, uncut, rigid vegetation covers &gt; 90% of the area of the wetland ..... points = 6</li> <li>Dense, uncut, rigid vegetation &gt; 1/2 area of wetland..... points = 3</li> <li>Dense, uncut, rigid vegetation &gt; 1/4 area..... points = 1</li> <li>More than 1/4 of area is grazed, mowed, tilled, or vegetation is not rigid ..... points = 0</li> </ul>	0
S 3.2	Characteristics of slope wetland that holds back small amounts of flood flows. The slope has small surface depressions that can retain water over at least 10% of its area. YES = 2 points                      NO = 0 points	0
Add the points in the boxes above		<b>0</b>
<b>S 4</b>	<b>Does the wetland have the opportunity to reduce flooding and erosion?</b> Is the wetland in a landscape position where the reduction in water velocity it provides helps protect downstream property and aquatic resources from flooding or excessive and/or erosive flows? Note which of the following conditions apply. _____ Wetland has surface runoff that drains to a river or stream that has flooding problems _____ Other _____ (Answer NO if the major source of water is controlled by a reservoir (e.g. wetland is a seep that is on the downstream side of a dam) YES multiplier is 2                      NO multiplier is 1	(see p. 70)  Multiplier  <u> X1 </u>
<b>◆ TOTAL – Hydrologic Functions</b> Multiply the score from S3 by S4; then add score to table on p. 1		<b>0</b>

Comments: Wetland A is adjacent to estuarine wetland but separate in that Wetland A is not influenced by salt water. Freshwater flows through Wetland A in one direction and enters North Bay.





These questions apply to wetlands of all HGM classes.		Points
HABITAT FUNCTIONS – Indicators that wetland functions to provide important habitat.		(only 1 score per box)
<b>H 1</b>	<b>Does the wetland have the <u>potential</u> to provide habitat for many species?</b>	
H 1.1	<p><u>Vegetation structure</u> (see P. 72):                      Check the types of vegetation classes present (as defined by Cowardin) – Size threshold for each class is 1/4 acre or more than 10% of the area if unit is smaller than 2.5 acres.</p> <p><input type="checkbox"/> Aquatic Bed  <input checked="" type="checkbox"/> Emergent plants  <input type="checkbox"/> Scrub/shrub (areas where shrubs have &gt; 30% cover)  <input type="checkbox"/> Forested (areas where trees have &gt; 30% cover)                      If the unit has a forested class check if:  <input type="checkbox"/> The forested class has 3 out of 5 strata (canopy, sub-canopy, shrubs, herbaceous, moss/ground-cover) that each cover 20% within the forested polygon.                      Add the number of vegetation types that qualify. If you have:</p> <p style="text-align: right;"><b>Map of Cowardin vegetation classes</b></p> <p style="text-align: right;">4 structures or more..... points = 4                      3 structures ..... points = 2                      1 structure ..... points = 0</p>	Figure ____  0
H 1.2	<p><u>Hydroperiods</u> (see p.73):                      Check the types of water regimes (hydroperiods) present within the wetland. The water regime has to cover more than 10% of the wetland or 1/4 acre to count (see text for descriptions of hydroperiods).</p> <p><input type="checkbox"/> Permanently flooded or inundated  <input type="checkbox"/> Seasonally flooded or inundated  <input type="checkbox"/> Occasionally flooded or inundated  <input checked="" type="checkbox"/> Saturated only</p> <p style="text-align: right;">4 or more types present points = 3                      3 or more types present ..... points = 2                      2 types present ..... points = 1                      1 type present ..... points = 0</p> <p><input type="checkbox"/> Permanently flowing stream or river in, or adjacent to, the wetland  <input type="checkbox"/> Seasonally flowing stream in, or adjacent to, the wetland  <input type="checkbox"/> <b>Lake-fringe wetland..... = 2 points</b>  <input type="checkbox"/> <b>Freshwater tidal wetland ..... = 2 points</b></p> <p style="text-align: right;"><b>Map of hydroperiods</b></p>	Figure ____  0
H 1.3	<p><u>Richness of Plant Species</u> (see p. 75):                      Count the number of plant species in the wetland that cover at least 10 ft<sup>2</sup> (different patches of the same species can be combined to meet the size threshold)                      You do not have to name the species. Do not include Eurasian Milfoil, reed canarygrass, purple loosestrife, Canadian Thistle.</p> <p style="text-align: right;">If you counted: &gt; 19 species ..... points = 2                      5 – 19 species ..... points = 1                      &lt; 5 species ..... points = 0</p> <p>List species below if you want to:                      _____                      _____                      _____</p>	1
H 1.4	<p><u>Interspersion of Habitats</u> (see p. 76):                      Decided from the diagrams below whether interspersion between Cowardin vegetation (described in H1.1), or the classes and unvegetated areas (can include open water or mudflats) is high, medium, low, or none.</p> <div style="display: flex; justify-content: space-around; align-items: flex-start;"> <div style="text-align: center;">  <p>None = 0 points</p> </div> <div style="text-align: center;">  <p>Low = 1 point</p> </div> <div style="text-align: center;">  <p>Moderate = 2 points</p> </div> <div style="text-align: center;">  <p>High = 3 points</p> </div> </div> <p style="text-align: center;">[riparian braided channels]</p> <p style="text-align: right;">Note: If you have 4 or more classes or 3 vegetation classes and open water, the rating is always “high”.  Use map of Cowardin classes.</p>	Figure ____  0
H 1.5	<p><u>Special Habitat Features</u> (see p. 77):                      Check the habitat features that are present in the wetland. The number of checks is the number of points you put into the next column.</p> <p><input type="checkbox"/> Large, downed, woody debris within the wetland (&gt; 4 in. diameter and 6 ft. long)  <input type="checkbox"/> Standing snags (diameter at the bottom &gt; 4 inches) in the wetland  <input type="checkbox"/> Undercut banks are present for at least 6.6 ft. (2m) and/or overhanging vegetation extends at least 3.3 ft. (1m) over a stream (or ditch) in, or contiguous with the unit, for at least 33 ft. (10m)  <input type="checkbox"/> Stable steep banks of fine material that might be used by beaver or muskrat for denning (&gt; 30 degree slope) OR signs of recent beaver activity are present (cut shrubs or trees that have not yet turned grey/brown)  <input type="checkbox"/> At least 1/4 acre of thin-stemmed persistent vegetation or woody branches are present in areas that are permanently or seasonally inundated (structures for egg-laying by amphibians)  <input type="checkbox"/> Invasive plants cover less than 25% of the wetland area in each stratum of plants</p> <p><i>NOTE: The 20% stated in early printings of the manual on page 78 is an error.</i></p>	0
<b>H 1 TOTAL Score</b> – potential for providing habitat		1

Exhibit 16  
 SSSP 2015-00215  
 001255



	<p>H 2.3 <u>Near or adjacent to other priority habitats listed by WDFW</u> (see p. 82): (see new and complete descriptions of WDFW priority habitats, and the counties in which they can be found, in the PHS report <a href="http://wdfw.wa.gov/hab/phslist.htm">http://wdfw.wa.gov/hab/phslist.htm</a> )</p> <p>Which of the following priority habitats are within 330 ft. (100m) of the wetland unit?  <i>NOTE: the connections do not have to be relatively undisturbed.</i></p> <p>___ <b>Aspen Stands:</b> Pure or mixed stands of aspen greater than 0.4 ha (1 acre).</p> <p>___ <b>Biodiversity Areas and Corridors:</b> Areas of habitat that are relatively important to various species of native fish and wildlife (full descriptions in WDFW PHS report p. 152).</p> <p>___ <b>Herbaceous Balds:</b> Variable size patches of grass and forbs on shallow soils over bedrock.</p> <p>___ <b>Old-growth/Mature forests:</b> (Old-growth west of Cascade crest) Stands of at least 2 tree species, forming a multi-layered canopy with occasional small openings; with at least 20 trees/ha (8 trees/acre) &gt; 81 cm (32 in) dbh or &gt; 200 years of age. (Mature forests) Stands with average diameters exceeding 53 cm (21 in) dbh; crown cover may be less than 100%; decay, decadence, numbers of snags, and quantity of large downed material is generally less than that found in old-growth; 80 - 200 years old west of the Cascade crest.</p> <p>___ <b>Oregon white Oak:</b> Woodlands Stands of pure oak or oak/conifer associations where canopy coverage of the oak component is important (full descriptions in WDFW PHS report p. 158).</p> <p>___ <b>Riparian:</b> The area adjacent to aquatic systems with flowing water that contains elements of both aquatic and terrestrial ecosystems which mutually influence each other.</p> <p>___ <b>Westside Prairies:</b> Herbaceous, non-forested plant communities that can either take the form of a dry prairie or a wet prairie (full descriptions in WDFW PHS report p. 161).</p> <p>___ <b>Instream:</b> The combination of physical, biological, and chemical processes and conditions that interact to provide functional life history requirements for instream fish and wildlife resources.</p> <p>___ <b>Nearshore:</b> Relatively undisturbed nearshore habitats. These include Coastal Nearshore, Open Coast Nearshore, and Puget Sound Nearshore. (full descriptions of habitats and the definition of relatively undisturbed are in WDFW report: pp. 167-169 and glossary in Appendix A).</p> <p>___ <b>Caves:</b> A naturally occurring cavity, recess, void, or system of interconnected passages under the earth in soils, rock, ice, or other geological formations and is large enough to contain a human.</p> <p>___ <b>Cliffs:</b> Greater than 7.6 m (25 ft) high and occurring below 5000 ft.</p> <p>___ <b>Talus:</b> Homogenous areas of rock rubble ranging in average size 0.15 - 2.0 m (0.5 - 6.5 ft), composed of basalt, andesite, and/or sedimentary rock, including riprap slides and mine tailings. May be associated with cliffs.</p> <p>___ <b>Snags and Logs:</b> Trees are considered snags if they are dead or dying and exhibit sufficient decay characteristics to enable cavity excavation/use by wildlife. Priority snags have a diameter at breast height of &gt; 51 cm (20 in) in western Washington and are &gt; 2 m (6.5 ft) in height. Priority logs are &gt; 30 cm (12 in) in diameter at the largest end, and &gt; 6 m (20 ft) long.</p> <p>If wetland has <b>3 or more</b> priority habitats = <b>4 points</b>                  If wetland has <b>2</b> priority habitats = <b>3 points</b>                  If wetland has <b>1</b> priority habitat = <b>1 point</b>                      No habitats = 0 points</p> <p>Note: All vegetated wetlands are by definition a priority habitat but are not included in this list. Nearby wetlands are addressed in question H 2.4)</p>	0
	<p>H 2.4 <u>Wetland Landscape:</u> Choose the <b>one</b> description of the landscape around the wetland that best fits (see p. 84)</p> <ul style="list-style-type: none"> <li>• There are at least 3 other wetlands within 1/2 mile, and the connections between them are relatively undisturbed (light grazing between wetlands OK, as is lake shore with some boating, but connections should NOT be bisected by paved roads, fill, fields, or other development.....points = 5</li> <li>• The wetland is Lake-fringe on a lake with little disturbance and there are 3 other lake-fringe wetlands within 1/2 mile .....points = 5</li> <li>• There are at least 3 other wetlands within 1/2 mile, BUT the connections between them are disturbed. ....points = 3</li> <li>• The wetland fringe on a lake <b>with</b> disturbance and there are 3 other lake-fringe wetlands within 1/2 mile .....points = 3</li> <li>• There is at least 1 wetland within 1/2 mile .....points = 2</li> <li>• There are no wetlands within 1/2 mile.....points = 0</li> </ul>	3
	<p><b>H 2 TOTAL Score</b> – opportunity for providing habitat                      <i>Add the scores from H2.1, H2.2, H2.3, H2.4</i></p>	4
	<p style="text-align: right;"><i>TOTAL for H 1 from page 8</i></p>	1
◆	<p><b>Total Score for Habitat Functions</b>                      Add the points for H 1 and H 2; then <b>record the result on p. 1</b></p>	5

Comments:

### CATEGORIZATION BASED ON SPECIAL CHARACTERISTICS

*Please determine if the wetland meets the attributes described below  
and circle the appropriate answers and Category.*

<b>Wetland Type</b> – Check off any criteria that apply to the wetland. Circle the Category when the appropriate criteria are met.		
<b>SC1</b>	<p><b>Estuarine wetlands?</b> (see p.86)</p> <p>Does the wetland unit meet the following criteria for Estuarine wetlands?</p> <p><input type="checkbox"/> The dominant water regime is tidal,  <input type="checkbox"/> Vegetated, and  <input type="checkbox"/> With a salinity greater than 0.5 ppt.</p> <p style="text-align: center;">YES = Go to SC 1.1                      NO <u>  X  </u></p>	
SC 1.1	<p>Is the wetland unit within a National Wildlife Refuge, National Park, National Estuary Reserve, Natural Area Preserve, State Park or Educational, Environmental, or Scientific Reserve designated under WAC 332-30-151?    YES = Category I                      NO = go to SC 1.2</p>	<b>Cat. I</b>
SC 1.2	<p>Is the wetland at least 1 acre in size and meets at least two of the following conditions?</p> <p style="text-align: center;">YES = Category I                      NO = Category II</p> <p><input type="checkbox"/> The wetland is relatively undisturbed (has no diking, ditching, filling, cultivation, grazing, and has less than 10% cover of non-native plant species. If the non-native <i>Spartina</i> spp., are only species that cover more than 10% of the wetland, then the wetland should be given a dual rating (I/II). The area of <i>Spartina</i> would be rated a Category II while the relatively undisturbed upper marsh with native species would be a Category I. Do not, however, exclude the area of <i>Spartina</i> in determining the size threshold of 1 acre.</p> <p><input type="checkbox"/> At least 3/4 of the landward edge of the wetland has a 100 ft. buffer of shrub, forest, or un-grazed or un-mowed grassland</p> <p><input type="checkbox"/> The wetland has at least 2 of the following features: tidal channels, depressions with open water, or contiguous freshwater wetlands.</p>	<b>Cat. I</b>  <b>Cat. II</b>  <b>Dual Rating I/II</b>
<b>SC2</b>	<p><b>Natural Heritage Wetlands</b> (see p. 87)</p> <p>Natural Heritage wetlands have been identified by the Washington Natural Heritage Program/DNR as either high quality undisturbed wetlands or wetlands that support state Threatened, Endangered, or Sensitive plant species.</p> <p>SC 2.1 Is the wetland being rated in a Section/Township/Range that contains a natural heritage wetland? (<i>This question is used to screen out most sites before you need to contact WNHP/DNR.</i>)</p> <p style="text-align: center;">S/T/R information from Appendix D _____ or accessed from WNHP/DNR web site _____</p> <p style="text-align: center;">YES _____ Contact WNHP/DNR (see p. 79) and go to SC 2.2                      NO <u>  X  </u></p> <p>SC 2.2 Has DNR identified the wetland as a high quality undisturbed wetland or as a site with state threatened or endangered plant species?</p> <p style="text-align: center;">YES = Category 1                      NO _____ not a Heritage Wetland</p>	<b>Cat I</b>
<b>SC3</b>	<p><b>Bogs</b> (see p. 87)</p> <p>Does the wetland (<b>or any part of the unit</b>) meet both the criteria for soils and vegetation in bogs? Use the key below to identify if the wetland is a bog. <i>If you answer yes you will still need to rate the wetland based on its function.</i></p> <p>1. Does the unit have organic soil horizons (i.e. layers of organic soil), either peats or mucks, that compose 16 inches or more of the first 32 inches of soil profile? (See Appendix B for a field key to identify organic soils)?    YES = go to question 3                      <b>NO = go to question 2</b></p> <p>2. Does the wetland have organic soils, either peats or mucks that are less than 16 inches deep over bedrock, or an impermeable hardpan such as clay or volcanic ash, or that are floating on a lake or pond?    YES = go to question 3                      <b>NO = is not a bog for purpose of rating</b></p> <p>3. Does the unit have more than 70% cover of mosses at ground level, AND other plants, if present, consist of the “bog” species listed in Table 3 as a significant component of the vegetation (more than 30% of the total shrub and herbaceous cover consists of species in Table 3)?</p> <p style="text-align: center;">YES = Is a bog for purpose of rating                      NO = go to question 4</p> <p>NOTE: If you are uncertain about the extent of mosses in the understory you may substitute that criterion by measuring the pH of the water that seeps into a hole dug at least 16” deep. If the pH is less than 5.0 and the “bog” plant species in Table 3 are present, the wetland is a bog.</p> <p>4. Is the unit forested (&gt; 30% cover) with sitka spruce, subalpine fir, western red cedar, western hemlock, lodgepole pine, quaking aspen, Englemann’s spruce, or western white pine. WITH any of the species (or combination of species) on the bog species plant list in Table 3 as a significant component of the ground cover (&gt; 30% coverage of the total shrub/herbaceous cover)?</p> <p style="text-align: center;">YES = Category I                      NO = Is not a bog for purpose of rating</p>	<b>Cat. I</b>

**Exhibit 16**  
**SSDP2016-00415**  
**001258**

SC4	<p><b>Forested Wetlands</b> (see p. 90)</p> <p>Does the wetland have at least 1 acre of forest that meet one of these criteria for the Department of Fish and Wildlife's forests as priority habitats? <i>If you answer yes you will still need to rate the wetland based on its function.</i></p> <p>___ <b>Old-growth forests:</b> (west of Cascade Crest) Stands of at least two three species forming a multi-layered canopy with occasional small openings; with at least 8 trees/acre (20 trees/hectare) that are at least 200 years of age OR have a diameter at breast height (dbh) of 32 inches (81 cm or more).</p> <p>NOTE: The criterion for dbh is based on measurements for upland forests. Two-hundred year old trees in wetlands will often have a smaller dbh because their growth rates are often slower. The DFW criterion is and "OR" so old-growth forests do not necessarily have to have trees of this diameter.</p> <p>___ <b>Mature forests:</b> (west of the Cascade Crest) Stands where the largest trees are 80 – 200 years old OR have an average diameters (dbh) exceeding 21 inches (53 cm); crown cover may be less than 100%; decay, decadence, numbers of snags, and quantity of large downed material is generally less than that found in old-growth.</p> <p>YES = Category I                      NO = <u> X </u> not a forested wetland with special characteristics</p>	Cat. I
SC5	<p><b>Wetlands in Coastal Lagoons</b> (see p. 91)</p> <p>Does the wetland meet all of the following criteria of a wetland in a coastal lagoon?</p> <p>___ The wetland lies in a depression adjacent to marine waters that is wholly or partially separated from marine waters by sandbanks, gravel banks, shingle, or, less frequently, rocks.</p> <p>___ The lagoon in which the wetland is located contains surface water that is saline or brackish (&gt; 0.5 ppt) during most of the year in at least a portion of the lagoon (<i>needs to be measured near the bottom.</i>)</p> <p>YES = Go to SC 5.1                      NO <u> X </u> not a wetland in a coastal lagoon</p> <p>SC 5.1 Does the wetland meet all of the following three conditions?</p> <p>___ The wetland is relatively undisturbed (has no diking, ditching, filling, cultivation, grazing) and has less than 20% cover of invasive plant species (see list of invasive species on p. 74).</p> <p>___ At least 3/4 of the landward edge of the wetland has a 100 ft. buffer of shrub, forest, or un-grazed or un-mowed grassland.</p> <p>___ The wetland is larger than 1/10 acre (4350 square ft.)</p> <p>YES = Category I                      NO = Category II</p>	Cat. I Cat. II
SC6	<p><b>Interdunal Wetlands</b> (see p. 93)</p> <p>Is the wetland west of the 1889 line (also called the Western Boundary of Upland Ownership or WBUO)?</p> <p>YES = Go to SC 6.1                      NO <u> X </u> not an interdunal wetland for rating</p> <p><b><i>If you answer yes you will still need to rate the wetland based on its functions.</i></b></p> <p>In practical terms that means the following geographic areas:</p> <ul style="list-style-type: none"> <li>• Long Beach Peninsula -- lands west of SR 103</li> <li>• Grayland-Westport -- lands west of SR 105</li> <li>• Ocean Shores-Copalis – lands west of SR 115 and SR 109</li> </ul> <p>SC 6.1 Is the wetland one acre or larger, or is it in a mosaic of wetlands that is one acre or larger?</p> <p>YES = Category II                      NO = go to SC 6.2</p> <p>SC 6.2 Is the wetland between 0.1 and 1 acre, or is it in a mosaic of wetlands that is between 0.1 and 1 acre?</p> <p>YES = Category III</p>	Cat. II Cat. III
◆	<p><b>Category of wetland based on Special Characteristics</b></p> <p><i>Choose the "highest" rating if wetland falls into several categories, and record on p. 1.</i></p> <p>If you answered NO for all types enter "Not Applicable" on p. 1</p>	NA

Comments:



Wetland name or number 29C

**WETLAND RATING FORM – WESTERN WASHINGTON**  
Version 2 – Updated July 2006 to increase accuracy and reproducibility among users  
Updated Oct. 2008 with the new WDFW definitions for priority habitats

Name of wetland (if known): 29C Date of site visit: 03-20-14

Rated by: Colin Worsley / Matt Maynard Trained by Ecology? Yes  No  Date of training: 11-2005 / 04-2006

SEC: 29 TWNSHP: 25N RNGE: 06E Is S/T/R in Appendix D? Yes  No

Map of wetland unit: Figure \_\_\_\_\_ Estimated size 0.05 acre

**SUMMARY OF RATING**

Category based on FUNCTIONS provided by wetland: I \_\_\_\_\_ II \_\_\_\_\_ III X IV \_\_\_\_\_

Category I =	Score > 70
Category II =	Score 51 - 69
Category III =	Score 30 – 50
Category IV =	Score < 30

Score for Water Quality Functions	18
Score for Hydrologic Functions	12
Score for Habitat Functions	15
<b>TOTAL Score for Functions</b>	<b>45</b>

Category based on SPECIAL CHARACTERISTICS of Wetland I \_\_\_\_\_ II \_\_\_\_\_ Does not apply X

**Final Category** (choose the “highest” category from above”) **III**

**Summary of basic information about the wetland unit.**

Wetland Unit has Special Characteristics		Wetland HGM Class used for Rating	
<b>Estuarine</b>		<b>Depressional</b>	
<b>Natural Heritage Wetland</b>		<b>Riverine</b>	
<b>Bog</b>		<b>Lake-fringe</b>	<b>X</b>
<b>Mature Forest</b>		<b>Slope</b>	<b>(x)</b>
<b>Old Growth Forest</b>		<b>Flats</b>	
<b>Coastal Lagoon</b>		<b>Freshwater Tidal</b>	
<b>Interdunal</b>			
None of the above	<b>X</b>	Check if unit has multiple HGM classes present	<b>X</b>

**Does the wetland being rated meet any of the criteria below?** If you answer YES to any of the questions below you will need to protect the wetland according to the regulations regarding the special characteristics found in the wetland.

Check List for Wetlands that Need Additional Protection (in addition to the protection recommended for its category)	YES	NO
SP1. <i>Has the wetland unit been documented as a habitat for any Federally listed Threatened or Endangered <b>animal or plant</b> species (T/E species)?</i> For the purposes of this rating system, “documented” means the wetland is on the appropriate state or federal database.		X
SP2. <i>Has the wetland unit been documented as habitat for any State listed Threatened or Endangered <b>animal</b> species?</i> For the purposes of this rating system, “documented” means the wetland is on the appropriate state database. Note: Wetlands with State listed plant species are categorized as Category 1 Natural Heritage Wetlands (see p. 19 of data form).		X
SP3. <i>Does the wetland unit contain individuals of Priority species listed by the WDFW for the state?</i>		X
SP4. <i>Does the wetland unit have a local significance in addition to its functions?</i> For example, the wetland has been identified in the Shoreline Master Program, the Critical Areas Ordinance, or in a local management plan as having special significance.		X

To complete the next part of the data sheet you will need to determine the Hydrogeomorphic Class of the wetland being rated.

Exhibit 16  
SSDP2016-00415  
001200

The hydrogeomorphic classification groups wetlands in to those that function in similar ways. This simplifies the questions needed to answer how well the wetland functions. The Hydrogeomorphic Class of a wetland can be determined using the key below. See p. 24 for more detailed instructions on classifying wetlands.  
Wetland Rating Form – Western Washington, Version 2 (7/06), updated with new WDFW definitions Oct. 2008

### Classification of Vegetated Wetlands for Western Washington

If the hydrologic criteria listed in each question do not apply to the entire unit being rated, you probably have a unit with multiple HGM classes. In this case, identify which hydrologic criteria in questions 1-7 apply, and go to Question 8.

1. Are the water levels in the entire unit usually controlled by tides (i.e. except during floods)?  
NO – go to 2                      **YES – the wetland class is Tidal Fringe**  
 If yes, is the salinity of the water during periods of annual low flow below 0.5 ppt (parts per thousand)?  
**YES – Freshwater Tidal Fringe**                      **NO – Saltwater Tidal Fringe (Estuarine)**  
*If your wetland can be classified as a Freshwater Tidal Fringe use the forms for Riverine wetlands. If it is a Saltwater Tidal Fringe it is rated as an Estuarine wetland. Wetlands that were call estuarine in the first and second editions of the rating system are called Salt Water Tidal Fringe in the Hydrogeomorphic Classification. Estuarine wetlands were categorized separately in the earlier editions, and this separation is being kept in this revision. To maintain consistency between editions, the term “Estuarine” wetland is kept. Please note, however, that the characteristics that define Category I and II estuarine wetlands have changed (see p. \_\_\_\_).*

---

2. The entire wetland unit is flat and precipitation is only source (>90%) of water to it. Groundwater and surface water runoff are NOT sources of water to the unit.  
NO – go to 3                      **YES – The wetland class is Flats**  
 If your wetland can be classified as a “Flats” wetland, use the form for **Depressional** wetlands.

---

3. Does the entire wetland meet both of the following criteria?  
 X The vegetated part of the wetland is on the shores of a body of permanent open water (without any vegetation on the surface) where at least 20 acres (8ha) in size;  
 X At least 30% of the open water area is deeper than 6.6 (2 m)?  
NO – go to 4                      **YES – The wetland class is Lake-fringe (Lacustrine Fringe)**

---

4. Does the entire wetland meet all of the following criteria?  
 The wetland is on a slope (*slope can be very gradual*).  
 The water flows through the wetland in one direction (unidirectional) and usually comes from seeps. It may flow subsurface, as sheetflow, or in a swale without distinct banks.  
 The water leaves the wetland **without being impounded**?  
*NOTE: Surface water does not pond in these types of wetlands except occasionally in very small and shallow depressions or behind hummocks (depressions are usually <3 ft diameter and less than 1 foot deep).*  
NO – go to 5                      **YES – The wetland class is Slope**

---

5. Does the entire wetland meet all of the following criteria?  
 The unit is in a valley or stream channel where it gets inundated by overbank flooding from that stream or river.  
 The overbank flooding occurs at least once every two years.  
*NOTE: The riverine unit can contain depressions that are filled with water when the river is not flooding..*  
NO – go to 6                      **YES – The wetland class is Riverine**

---

6. Is the entire wetland unit in a topographic depression in which water ponds, or is saturated to the surface, at some time of the year. This means that any outlet, if present is higher than the interior of the wetland.  
NO – go to 7                      **YES – The wetland class is Depressional**

---

7. Is the entire wetland located in a very flat area with no obvious depression and no overbank flooding. The unit does not pond surface water more than a few inches. The unit seems to be maintained by high groundwater in the area. The wetland may be ditched, but has no obvious natural outlet.  
No – go to 8                      **YES – The wetland class is Depressional**

---

8. Your wetland unit seems to be difficult to classify and probably contains several different HGM classes. For example, seeps at the base of a slope may grade into a riverine floodplain, or a small stream within a depressional wetland has a zone of flooding along its sides. **GO BACK AND IDENTIFY WHICH OF THE HYDROLOGIC REGIMES DESCRIBED IN QUESTIONS 1-7 APPLY TO DIFFERENT AREAS IN THE UNIT** (make a rough sketch to help you decide). Use the following table to identify the appropriate class to use for the rating system if you have several HGM classes present within your wetland. *NOTE: Use this table only if the class that is recommended in the second column represents 10% or more of the total area of the wetland unit being rated. If the area of the class listed in column 2 is less than 10% of the unit, classify the wetland using the class that represents more than 90% of the total area.*

HGM Classes within the wetland unit being rated	HGM Class to Use in Rating
Slope + Riverine	Riverine
Slope + Depressional	Depressional
Slope + Lake-fringe	Lake-fringe
Depressional + Riverine along stream within boundary	Depressional
Depressional + Lake-fringe	Depressional
Salt Water Tidal Fringe and any other class of freshwater wetland	Treat as ESTUARINE under wetlands with special characteristics

**Exhibit 16**  
**SSDP2016-00415**  
**001261**

If you are unable still to determine which of the above criteria apply to your wetland, or you have more than 2 HGM classes within a wetland boundary, classify the wetland as **Depressional** for the rating.

L Lake-fringe Wetlands		Points
WATER QUALITY FUNCTIONS – Indicators that the wetland unit functions to improve water quality.		(only 1 score per box)
<b>L 1</b>	<b>Does the wetland unit have the <u>potential</u> to improve water quality?</b> (see p.59)	
L 1.1	Average width of vegetation along the lakeshore (use polygons of Cowardin classes): • Vegetation is more than 33 ft. (10m) wide ..... points = 6 • Vegetation is more than 16 ft.(5m) wide and < 33 ft ..... points = 3 • Vegetation is more than 6 ft. (2m) wide and < 16 ft ..... points = 1 • Vegetation is less than 6 ft. wide..... points = 0 <b>Map of Cowardin classes with widths marked</b>	Figure ____ 6
L 1.2	Characteristics of the vegetation in the wetland: <i>Choose the appropriate description that results in the highest points, and do not include any open water in your estimate of coverage. The herbaceous plants can be either the dominant form or as an understory in a shrub or forest community. These are not Cowardin classes. Area of Cover is total cover in the unit, but it can be in patches. NOTE: Herbaceous does not include aquatic bed.</i> • Cover of herbaceous plants is > 90% of the vegetated area..... points = 6 • Cover of herbaceous plants is > 2/3 of the vegetated area..... points = 4 • Cover of herbaceous plants is > 1/3 of the vegetated area..... points = 3 • Other vegetation that is not aquatic bed or herbaceous covers > 2/3 of the unit ..... points = 3 • Other vegetation that is not aquatic bed in > 1/3 vegetated area ..... points = 1 • Aquatic bed cover and open water > 2/3 of the unit..... points = 0 <b>Map with polygons of different vegetation types</b>	Figure ____ 3
<i>Add the points in the boxes above</i>		9
<b>L 2</b>	<b>Does the wetland have the <u>opportunity</u> to improve water quality?</b>	(see p.61)
Answer YES if you know or believe there are pollutants in the lake water, or polluted surface water flowing through the unit to the lake. <i>Note which of the following conditions provide the sources of pollutants. A unit may have pollutants coming from several sources, but any single source would qualify as opportunity.</i> <input type="checkbox"/> Wetland is along the shores of a lake or reservoir that does not meet water quality standards <input type="checkbox"/> Grazing in the wetland or within 150 ft <input type="checkbox"/> Polluted water discharges to wetland along upland edge <input type="checkbox"/> Tilled fields or orchards within 150 ft. of wetland <input checked="" type="checkbox"/> Residential or urban areas are within 150 ft. of wetland <input type="checkbox"/> Parks with grassy areas that are maintained, ballfields, golf courses (all within 150 ft. of lake shore) <input checked="" type="checkbox"/> Power boats with gasoline or diesel engines use the lake <input type="checkbox"/> Other _____ YES multiplier is 2                      NO multiplier is 1		Multiplier X2
◆ <b>TOTAL – Water Quality Functions</b> Multiply the score from L1 by L2; then <i>add score to table on p. 1</i>		18
HYDROLOGIC FUNCTIONS – Indicators that wetland functions to reduce shoreline erosion.		
<b>L 3</b>	<b>Does the wetland have the <u>potential</u> to reduce shoreline erosion?</b>	(see p.62)
L 3	Average width and characteristics of vegetation along the lakeshore ( <i>do not include aquatic bed</i> ): ( <i>choose the highest scoring description that matches conditions in the wetland</i> ) • 3/4 of distance is shrubs or forest at least 33 ft. (10m) wide ..... points = 6 • 3/4 of distance is shrubs or forest at least 6 ft. (2m) wide ..... points = 4 • 1/4 of distance is shrubs or forest at least 33 ft. (10m) wide ..... points = 4 • Vegetation is at least 6 ft. (2m) wide (any type except aquatic bed)..... points = 2 • Vegetation is less than 6 ft. (2m) wide (any type except aquatic bed) ..... points = 0 <b>Aerial photo or map with Cowardin vegetation classes</b>	Figure ____ 6
<i>Record the points in the boxes above</i>		6
<b>L 4</b>	<b>Does the wetland have the <u>opportunity</u> to reduce erosion?</b>	(see p. 64)
Are there features along the shore that will be impacted if the shoreline erodes? <i>Note which of the following conditions apply.</i> <input checked="" type="checkbox"/> There are human structures and activities along the upland edge of the wetland (buildings, fields) that can be damaged by erosion. <input type="checkbox"/> There are undisturbed natural resources along the upland edge of the wetland (e.g. mature forests, other wetlands) that can be damaged by shoreline erosion. <input type="checkbox"/> Other _____ YES multiplier is 2                      NO multiplier is 1		Multiplier X2
◆ <b>TOTAL – Hydrologic Functions</b> Multiply the score from L3 by L4; then <i>add score to table on p. 1</i>		12

Comments: Deck, shed, and walkways in wetland.





These questions apply to wetlands of all HGM classes.		Points (only 1 score per box)
HABITAT FUNCTIONS – Indicators that wetland functions to provide important habitat.		
<b>H 1</b>	<b>Does the wetland have the potential to provide habitat for many species?</b>	
H 1.1	<p><b>Vegetation structure</b> (see P. 72):                      Check the types of vegetation classes present (as defined by Cowardin) – Size threshold for each class is 1/4 acre or more than 10% of the area if unit is smaller than 2.5 acres.</p> <p><input type="checkbox"/> Aquatic Bed  <input type="checkbox"/> Emergent plants  <input type="checkbox"/> Scrub/shrub (areas where shrubs have &gt; 30% cover)  <input checked="" type="checkbox"/> Forested (areas where trees have &gt; 30% cover)                      If the unit has a forested class check if:  <input checked="" type="checkbox"/> The forested class has 3 out of 5 strata (canopy, sub-canopy, shrubs, herbaceous, moss/ground-cover) that each cover 20% within the forested polygon.                      Add the number of vegetation types that qualify. If you have:</p> <p style="text-align: right;"><b>Map of Cowardin vegetation classes</b></p> <p style="text-align: right;">4 structures or more ..... points = 4                      3 structures ..... points = 2                      2 structures ..... points = 1                      1 structure ..... points = 0</p>	Figure ____  1
H 1.2	<p><b>Hydroperiods</b> (see p.73):                      Check the types of water regimes (hydroperiods) present within the wetland. The water regime has to cover more than 10% of the wetland or 1/4 acre to count (see text for descriptions of hydroperiods).</p> <p><input type="checkbox"/> Permanently flooded or inundated  <input type="checkbox"/> Seasonally flooded or inundated  <input type="checkbox"/> Occasionally flooded or inundated  <input type="checkbox"/> Saturated only  <input type="checkbox"/> Permanently flowing stream or river in, or adjacent to, the wetland  <input type="checkbox"/> Seasonally flowing stream in, or adjacent to, the wetland  <input checked="" type="checkbox"/> Lake-fringe wetland ..... = 2 points  <input type="checkbox"/> Freshwater tidal wetland ..... = 2 points</p> <p style="text-align: right;"><b>Map of hydroperiods</b></p> <p style="text-align: right;">4 or more types present points = 3                      3 or more types present ..... points = 2                      2 types present ..... points = 1                      1 type present ..... points = 0</p>	Figure ____  2
H 1.3	<p><b>Richness of Plant Species</b> (see p. 75):                      Count the number of plant species in the wetland that cover at least 10 ft<sup>2</sup> (different patches of the same species can be combined to meet the size threshold)                      You do not have to name the species. Do not include Eurasian Milfoil, reed canarygrass, purple loosestrife, Canadian Thistle.                      If you counted: &gt; 19 species ..... points = 2                      5 – 19 species ..... points = 1                      &lt; 5 species ..... points = 0</p> <p>List species below if you want to:                      _____                      _____                      _____</p>	1
H 1.4	<p><b>Interspersion of Habitats</b> (see p. 76):                      Decided from the diagrams below whether interspersion between Cowardin vegetation (described in H1.1), or the classes and unvegetated areas (can include open water or mudflats) is high, medium, low, or none.</p> <div style="display: flex; justify-content: space-around;"> <div style="text-align: center;">  <p>None = 0 points</p> </div> <div style="text-align: center;">  <p>Low = 1 point</p> </div> <div style="text-align: center;">  <p>Moderate = 2 points</p> </div> <div style="text-align: center;">  <p>High = 3 points</p> </div> </div> <p style="text-align: center;">[riparian braided channels]</p> <p style="text-align: right;">Note: If you have 4 or more classes or 3 vegetation classes and open water, the rating is always “high”.</p> <p style="text-align: right;"><b>Use map of Cowardin classes.</b></p>	Figure ____  0
H 1.5	<p><b>Special Habitat Features</b> (see p. 77):                      Check the habitat features that are present in the wetland. The number of checks is the number of points you put into the next column.</p> <p><input checked="" type="checkbox"/> Large, downed, woody debris within the wetland (&gt; 4 in. diameter and 6 ft. long)  <input checked="" type="checkbox"/> Standing snags (diameter at the bottom &gt; 4 inches) in the wetland  <input type="checkbox"/> Undercut banks are present for at least 6.6 ft. (2m) and/or overhanging vegetation extends at least 3.3 ft. (1m) over a stream (or ditch) in, or contiguous with the unit, for at least 33 ft. (10m)  <input type="checkbox"/> Stable steep banks of fine material that might be used by beaver or muskrat for denning (&gt; 30 degree slope) OR signs of recent beaver activity are present (cut shrubs or trees that have not yet turned grey/brown)  <input type="checkbox"/> At least 1/4 acre of thin-stemmed persistent vegetation or woody branches are present in areas that are permanently or seasonally inundated (structures for egg-laying by amphibians)  <input checked="" type="checkbox"/> Invasive plants cover less than 25% of the wetland area in each stratum of plants                      NOTE: The 20% stated in early printings of the manual on page 78 is an error.</p>	3
<b>H 1 TOTAL Score</b> – potential for providing habitat		7

Exhibit 16  
 SSSP 2016-00215  
 001263



	<p>H 2.3 <u>Near or adjacent to other priority habitats listed by WDFW</u> (see p. 82): (see new and complete descriptions of WDFW priority habitats, and the counties in which they can be found, in the PHS report <a href="http://wdfw.wa.gov/hab/phslist.htm">http://wdfw.wa.gov/hab/phslist.htm</a> )</p> <p>Which of the following priority habitats are within 330 ft. (100m) of the wetland unit?  <i>NOTE: the connections do not have to be relatively undisturbed.</i></p> <p><input type="checkbox"/> <b>Aspen Stands:</b> Pure or mixed stands of aspen greater than 0.4 ha (1 acre).</p> <p><input type="checkbox"/> <b>Biodiversity Areas and Corridors:</b> Areas of habitat that are relatively important to various species of native fish and wildlife (full descriptions in WDFW PHS report p. 152).</p> <p><input type="checkbox"/> <b>Herbaceous Balds:</b> Variable size patches of grass and forbs on shallow soils over bedrock.</p> <p><input type="checkbox"/> <b>Old-growth/Mature forests:</b> (Old-growth west of Cascade crest) Stands of at least 2 tree species, forming a multi-layered canopy with occasional small openings; with at least 20 trees/ha (8 trees/acre) &gt; 81 cm (32 in) dbh or &gt; 200 years of age. (Mature forests) Stands with average diameters exceeding 53 cm (21 in) dbh; crown cover may be less than 100%; decay, decadence, numbers of snags, and quantity of large downed material is generally less than that found in old-growth; 80 - 200 years old west of the Cascade crest.</p> <p><input type="checkbox"/> <b>Oregon white Oak:</b> Woodlands Stands of pure oak or oak/conifer associations where canopy coverage of the oak component is important (full descriptions in WDFW PHS report p. 158).</p> <p><input checked="" type="checkbox"/> <b>Riparian:</b> The area adjacent to aquatic systems with flowing water that contains elements of both aquatic and terrestrial ecosystems which mutually influence each other.</p> <p><input type="checkbox"/> <b>Westside Prairies:</b> Herbaceous, non-forested plant communities that can either take the form of a dry prairie or a wet prairie (full descriptions in WDFW PHS report p. 161).</p> <p><input checked="" type="checkbox"/> <b>Instream:</b> The combination of physical, biological, and chemical processes and conditions that interact to provide functional life history requirements for instream fish and wildlife resources.</p> <p><input type="checkbox"/> <b>Nearshore:</b> Relatively undisturbed nearshore habitats. These include Coastal Nearshore, Open Coast Nearshore, and Puget Sound Nearshore. (full descriptions of habitats and the definition of relatively undisturbed are in WDFW report: pp. 167-169 and glossary in Appendix A).</p> <p><input type="checkbox"/> <b>Caves:</b> A naturally occurring cavity, recess, void, or system of interconnected passages under the earth in soils, rock, ice, or other geological formations and is large enough to contain a human.</p> <p><input type="checkbox"/> <b>Cliffs:</b> Greater than 7.6 m (25 ft) high and occurring below 5000 ft.</p> <p><input type="checkbox"/> <b>Talus:</b> Homogenous areas of rock rubble ranging in average size 0.15 - 2.0 m (0.5 - 6.5 ft), composed of basalt, andesite, and/or sedimentary rock, including riprap slides and mine tailings. May be associated with cliffs.</p> <p><input type="checkbox"/> <b>Snags and Logs:</b> Trees are considered snags if they are dead or dying and exhibit sufficient decay characteristics to enable cavity excavation/use by wildlife. Priority snags have a diameter at breast height of &gt; 51 cm (20 in) in western Washington and are &gt; 2 m (6.5 ft) in height. Priority logs are &gt; 30 cm (12 in) in diameter at the largest end, and &gt; 6 m (20 ft) long.</p> <p>If wetland has <b>3 or more</b> priority habitats = <b>4 points</b>  <b>If wetland has 2</b> priority habitats = <b>3 points</b>                  If wetland has <b>1</b> priority habitat = <b>1 point</b>                      No habitats = 0 points</p> <p>Note: All vegetated wetlands are by definition a priority habitat but are not included in this list. Nearby wetlands are addressed in question H 2.4)</p>	3
	<p>H 2.4 <u>Wetland Landscape:</u> Choose the <b>one</b> description of the landscape around the wetland that best fits (see p. 84)</p> <ul style="list-style-type: none"> <li>• There are at least 3 other wetlands within 1/2 mile, and the connections between them are relatively undisturbed (light grazing between wetlands OK, as is lake shore with some boating, but connections should NOT be bisected by paved roads, fill, fields, or other development.....points = 5</li> <li>• The wetland is Lake-fringe on a lake with little disturbance and there are 3 other lake-fringe wetlands within 1/2 mile .....points = 5</li> <li>• <b>There are at least 3 other wetlands within 1/2 mile, BUT the connections between them are disturbed.....points = 3</b></li> <li>• The wetland fringe on a lake <b>with</b> disturbance and there are 3 other lake-fringe wetlands within 1/2 mile .....points = 3</li> <li>• There is at least 1 wetland within 1/2 mile .....points = 2</li> <li>• There are no wetlands within 1/2 mile.....points = 0</li> </ul>	3
<p><b>H 2 TOTAL Score</b> – opportunity for providing habitat                      Add the scores from H2.1, H2.2, H2.3, H2.4</p>		8
<p style="text-align: right;"><i>TOTAL for H 1 from page 8</i></p>		7
◆	<p><b>Total Score for Habitat Functions</b>                      Add the points for H 1 and H 2; then <b>record the result on p. 1</b></p>	15

Comments:

## CATEGORIZATION BASED ON SPECIAL CHARACTERISTICS

*Please determine if the wetland meets the attributes described below  
and circle the appropriate answers and Category.*

Wetland Type – Check off any criteria that apply to the wetland. Circle the Category when the appropriate criteria are met.		
<b>SC1</b>	<p><b>Estuarine wetlands?</b> (see p.86)</p> <p>Does the wetland unit meet the following criteria for Estuarine wetlands?</p> <p><input type="checkbox"/> The dominant water regime is tidal,</p> <p><input type="checkbox"/> Vegetated, and</p> <p><input type="checkbox"/> With a salinity greater than 0.5 ppt.</p> <p style="text-align: center;">YES = Go to SC 1.1                      NO <u>  X  </u></p>	
SC 1.1	<p>Is the wetland unit within a National Wildlife Refuge, National Park, National Estuary Reserve, Natural Area Preserve, State Park or Educational, Environmental, or Scientific Reserve designated under WAC 332-30-151?      YES = Category I                      NO = go to SC 1.2</p>	<b>Cat. I</b>
SC 1.2	<p>Is the wetland at least 1 acre in size and meets at least two of the following conditions?</p> <p style="text-align: center;">YES = Category I                      NO = Category II</p> <p><input type="checkbox"/> The wetland is relatively undisturbed (has no diking, ditching, filling, cultivation, grazing, and has less than 10% cover of non-native plant species. If the non-native <i>Spartina</i> spp., are only species that cover more than 10% of the wetland, then the wetland should be given a dual rating (I/II). The area of <i>Spartina</i> would be rated a Category II while the relatively undisturbed upper marsh with native species would be a Category I. Do not, however, exclude the area of <i>Spartina</i> in determining the size threshold of 1 acre.</p> <p><input type="checkbox"/> At least 3/4 of the landward edge of the wetland has a 100 ft. buffer of shrub, forest, or un-grazed or un-mowed grassland</p> <p><input type="checkbox"/> The wetland has at least 2 of the following features: tidal channels, depressions with open water, or contiguous freshwater wetlands.</p>	<b>Cat. I</b>  <b>Cat. II</b>  <b>Dual Rating I/II</b>
<b>SC2</b>	<p><b>Natural Heritage Wetlands</b> (see p. 87)</p> <p>Natural Heritage wetlands have been identified by the Washington Natural Heritage Program/DNR as either high quality undisturbed wetlands or wetlands that support state Threatened, Endangered, or Sensitive plant species.</p> <p>SC 2.1 Is the wetland being rated in a Section/Township/Range that contains a natural heritage wetland? (<i>This question is used to screen out most sites before you need to contact WNHP/DNR.</i>)</p> <p style="text-align: center;">S/T/R information from Appendix D _____ or accessed from WNHP/DNR web site _____</p> <p style="text-align: center;">YES _____ Contact WNHP/DNR (see p. 79) and go to SC 2.2                      NO <u>  X  </u></p> <p>SC 2.2 Has DNR identified the wetland as a high quality undisturbed wetland or as a site with state threatened or endangered plant species?</p> <p style="text-align: center;">YES = Category 1                      NO _____ not a Heritage Wetland</p>	<b>Cat I</b>
<b>SC3</b>	<p><b>Bogs</b> (see p. 87)</p> <p>Does the wetland (<b>or any part of the unit</b>) meet both the criteria for soils and vegetation in bogs? Use the key below to identify if the wetland is a bog. <i>If you answer yes you will still need to rate the wetland based on its function.</i></p> <ol style="list-style-type: none"> <li>1. Does the unit have organic soil horizons (i.e. layers of organic soil), either peats or mucks, that compose 16 inches or more of the first 32 inches of soil profile? (See Appendix B for a field key to identify organic soils)?      YES = go to question 3      <b>NO = go to question 2</b></li> <li>2. Does the wetland have organic soils, either peats or mucks that are less than 16 inches deep over bedrock, or an impermeable hardpan such as clay or volcanic ash, or that are floating on a lake or pond?      YES = go to question 3      <b>NO = is not a bog for purpose of rating</b></li> <li>3. Does the unit have more than 70% cover of mosses at ground level, AND other plants, if present, consist of the “bog” species listed in Table 3 as a significant component of the vegetation (more than 30% of the total shrub and herbaceous cover consists of species in Table 3)?</li> </ol> <p style="text-align: center;">YES = Is a bog for purpose of rating                      NO = go to question 4</p> <p>NOTE: If you are uncertain about the extent of mosses in the understory you may substitute that criterion by measuring the pH of the water that seeps into a hole dug at least 16” deep. If the pH is less than 5.0 and the “bog” plant species in Table 3 are present, the wetland is a bog.</p> <ol style="list-style-type: none"> <li>4. Is the unit forested (&gt; 30% cover) with sitka spruce, subalpine fir, western red cedar, western hemlock, lodgepole pine, quaking aspen, Englemann’s spruce, or western white pine. WITH any of the species (or combination of species) on the bog species plant list in Table 3 as a significant component of the ground cover (&gt; 30% coverage of the total shrub/herbaceous cover)?</li> </ol> <p style="text-align: center;">YES = Category I                      NO = Is not a bog for purpose of rating</p>	<b>Cat. I</b>

**Exhibit 16**  
**SSDP2016-00415**  
**001266**

SC4	<p><b>Forested Wetlands</b> (see p. 90)</p> <p>Does the wetland have at least 1 acre of forest that meet one of these criteria for the Department of Fish and Wildlife's forests as priority habitats? <i>If you answer yes you will still need to rate the wetland based on its function.</i></p> <p>___ <b>Old-growth forests:</b> (west of Cascade Crest) Stands of at least two three species forming a multi-layered canopy with occasional small openings; with at least 8 trees/acre (20 trees/hectare) that are at least 200 years of age OR have a diameter at breast height (dbh) of 32 inches (81 cm or more).</p> <p>NOTE: The criterion for dbh is based on measurements for upland forests. Two-hundred year old trees in wetlands will often have a smaller dbh because their growth rates are often slower. The DFW criterion is and "OR" so old-growth forests do not necessarily have to have trees of this diameter.</p> <p>___ <b>Mature forests:</b> (west of the Cascade Crest) Stands where the largest trees are 80 – 200 years old OR have an average diameters (dbh) exceeding 21 inches (53 cm); crown cover may be less than 100%; decay, decadence, numbers of snags, and quantity of large downed material is generally less than that found in old-growth.</p> <p>YES = Category I                      NO = <u>X</u> not a forested wetland with special characteristics</p>	Cat. I
SC5	<p><b>Wetlands in Coastal Lagoons</b> (see p. 91)</p> <p>Does the wetland meet all of the following criteria of a wetland in a coastal lagoon?</p> <p>___ The wetland lies in a depression adjacent to marine waters that is wholly or partially separated from marine waters by sandbanks, gravel banks, shingle, or, less frequently, rocks.</p> <p>___ The lagoon in which the wetland is located contains surface water that is saline or brackish (&gt; 0.5 ppt) during most of the year in at least a portion of the lagoon (<i>needs to be measured near the bottom.</i>)</p> <p>YES = Go to SC 5.1                      NO <u>X</u> not a wetland in a coastal lagoon</p> <p>SC 5.1 Does the wetland meet all of the following three conditions?</p> <p>___ The wetland is relatively undisturbed (has no diking, ditching, filling, cultivation, grazing) and has less than 20% cover of invasive plant species (see list of invasive species on p. 74).</p> <p>___ At least 3/4 of the landward edge of the wetland has a 100 ft. buffer of shrub, forest, or un-grazed or un-mowed grassland.</p> <p>___ The wetland is larger than 1/10 acre (4350 square ft.)</p> <p>YES = Category I                      NO = Category II</p>	Cat. I Cat. II
SC6	<p><b>Interdunal Wetlands</b> (see p. 93)</p> <p>Is the wetland west of the 1889 line (also called the Western Boundary of Upland Ownership or WBUO)?</p> <p>YES = Go to SC 6.1                      NO <u>X</u> not an interdunal wetland for rating</p> <p><i>If you answer yes you will still need to rate the wetland based on its functions.</i></p> <p>In practical terms that means the following geographic areas:</p> <ul style="list-style-type: none"> <li>• Long Beach Peninsula -- lands west of SR 103</li> <li>• Grayland-Westport -- lands west of SR 105</li> <li>• Ocean Shores-Copalis – lands west of SR 115 and SR 109</li> </ul> <p>SC 6.1 Is the wetland one acre or larger, or is it in a mosaic of wetlands that is one acre or larger?</p> <p>YES = Category II                      NO = go to SC 6.2</p> <p>SC 6.2 Is the wetland between 0.1 and 1 acre, or is it in a mosaic of wetlands that is between 0.1 and 1 acre?</p> <p>YES = Category III</p>	Cat. II Cat. III
◆	<p><b>Category of wetland based on Special Characteristics</b></p> <p>Choose the "highest" rating if wetland falls into several categories, and record on p. 1.</p> <p>If you answered NO for all types enter "Not Applicable" on p. 1</p>	NA

**Comments:**

**Exhibit 16**  
**SSDP2016-00415**  
**001267**



Wetland name or number 29D

**WETLAND RATING FORM – WESTERN WASHINGTON**  
Version 2 – Updated July 2006 to increase accuracy and reproducibility among users  
Updated Oct. 2008 with the new WDFW definitions for priority habitats

Name of wetland (if known): 29D Date of site visit: 09-27-13

Rated by: Colin Worsley / Matt Maynard Trained by Ecology? Yes X No      Date of training: 11-2005 / 04-2006

SEC: 29 TOWNSHIP: 25N RANGE: 06E Is S/T/R in Appendix D? Yes      No X

Map of wetland unit: Figure      Estimated size 0.03 acre

**SUMMARY OF RATING**

Category based on FUNCTIONS provided by wetland: I      II      III      IV X

Category I =	Score > 70
Category II =	Score 51 - 69
Category III =	Score 30 – 50
Category IV =	Score < 30

Score for Water Quality Functions	12
Score for Hydrologic Functions	1
Score for Habitat Functions	12
<b>TOTAL Score for Functions</b>	<b>25</b>

Category based on SPECIAL CHARACTERISTICS of Wetland I      II      Does not apply X

**Final Category** (choose the “highest” category from above”) IV

**Summary of basic information about the wetland unit.**

Wetland Unit has Special Characteristics		Wetland HGM Class used for Rating	
<b>Estuarine</b>		<b>Depressional</b>	X
<b>Natural Heritage Wetland</b>		<b>Riverine</b>	
<b>Bog</b>		<b>Lake-fringe</b>	
<b>Mature Forest</b>		<b>Slope</b>	(x)
<b>Old Growth Forest</b>		<b>Flats</b>	
<b>Coastal Lagoon</b>		<b>Freshwater Tidal</b>	
<b>Interdunal</b>			
None of the above	X	Check if unit has multiple HGM classes present	X

**Does the wetland being rated meet any of the criteria below?** If you answer YES to any of the questions below you will need to protect the wetland according to the regulations regarding the special characteristics found in the wetland.

Check List for Wetlands that Need Additional Protection (in addition to the protection recommended for its category)	YES	NO
SP1. <i>Has the wetland unit been documented as a habitat for any Federally listed Threatened or Endangered <b>animal or plant</b> species (T/E species)?</i> For the purposes of this rating system, “documented” means the wetland is on the appropriate state or federal database.		X
SP2. <i>Has the wetland unit been documented as habitat for any State listed Threatened or Endangered <b>animal</b> species?</i> For the purposes of this rating system, “documented” means the wetland is on the appropriate state database. Note: Wetlands with State listed plant species are categorized as Category 1 Natural Heritage Wetlands (see p. 19 of data form).		X
SP3. <i>Does the wetland unit contain individuals of Priority species listed by the WDFW for the state?</i>		X
SP4. <i>Does the wetland unit have a local significance in addition to its functions?</i> For example, the wetland has been identified in the Shoreline Master Program, the Critical Areas Ordinance, or in a local management plan as having special significance.		X

To complete the next part of the data sheet you will need to determine the Hydrogeomorphic Class of the wetland being rated.

Exhibit 16  
SSDP2016-00415  
001208

### Classification of Vegetated Wetlands for Western Washington

If the hydrologic criteria listed in each question do not apply to the entire unit being rated, you probably have a unit with multiple HGM classes. In this case, identify which hydrologic criteria in questions 1-7 apply, and go to Question 8.

1. Are the water levels in the entire unit usually controlled by tides (i.e. except during floods)?  
NO – go to 2                      **YES – the wetland class is Tidal Fringe**  
 If yes, is the salinity of the water during periods of annual low flow below 0.5 ppt (parts per thousand)?  
**YES – Freshwater Tidal Fringe**                      **NO – Saltwater Tidal Fringe (Estuarine)**  
*If your wetland can be classified as a Freshwater Tidal Fringe use the forms for Riverine wetlands. If it is a Saltwater Tidal Fringe it is rated as an Estuarine wetland. Wetlands that were call estuarine in the first and second editions of the rating system are called Salt Water Tidal Fringe in the Hydrogeomorphic Classification. Estuarine wetlands were categorized separately in the earlier editions, and this separation is being kept in this revision. To maintain consistency between editions, the term “Estuarine” wetland is kept. Please note, however, that the characteristics that define Category I and II estuarine wetlands have changed (see p. \_\_\_\_\_).*

---

2. The entire wetland unit is flat and precipitation is only source (>90%) of water to it. Groundwater and surface water runoff are NOT sources of water to the unit.  
NO – go to 3                      **YES – The wetland class is Flats**  
 If your wetland can be classified as a “Flats” wetland, use the form for **Depressional** wetlands.

---

3. Does the entire wetland meet both of the following criteria?  
 \_\_\_\_\_ The vegetated part of the wetland is on the shores of a body of permanent open water (without any vegetation on the surface) where at least 20 acres (8ha) in size;  
 \_\_\_\_\_ At least 30% of the open water area is deeper than 6.6 (2 m)?  
NO – go to 4                      **YES – The wetland class is Lake-fringe (Lacustrine Fringe)**

---

4. Does the entire wetland meet all of the following criteria?  
 \_\_\_\_\_ The wetland is on a slope (*slope can be very gradual*).  
 \_\_\_\_\_ The water flows through the wetland in one direction (unidirectional) and usually comes from seeps. It may flow subsurface, as sheetflow, or in a swale without distinct banks.  
 \_\_\_\_\_ The water leaves the wetland **without being impounded**?  
 NOTE: *Surface water does not pond in these types of wetlands except occasionally in very small and shallow depressions or behind hummocks (depressions are usually <3 ft diameter and less than 1 foot deep).*  
NO – go to 5                      **YES – The wetland class is Slope**

---

5. Does the entire wetland meet all of the following criteria?  
 \_\_\_\_\_ The unit is in a valley or stream channel where it gets inundated by overbank flooding from that stream or river.  
 \_\_\_\_\_ The overbank flooding occurs at least once every two years.  
 NOTE: *The riverine unit can contain depressions that are filled with water when the river is not flooding..*  
NO – go to 6                      **YES – The wetland class is Riverine**

---

6. Is the entire wetland unit in a topographic depression in which water ponds, or is saturated to the surface, at some time of the year. This means that any outlet, if present is higher than the interior of the wetland.  
NO – go to 7                      **YES – The wetland class is Depressional**

---

7. Is the entire wetland located in a very flat area with no obvious depression and no overbank flooding. The unit does not pond surface water more than a few inches. The unit seems to be maintained by high groundwater in the area. The wetland may be ditched, but has no obvious natural outlet.  
No – go to 8                      **YES – The wetland class is Depressional**

---

8. Your wetland unit seems to be difficult to classify and probably contains several different HGM classes. For example, seeps at the base of a slope may grade into a riverine floodplain, or a small stream within a depressional wetland has a zone of flooding along its sides. **GO BACK AND IDENTIFY WHICH OF THE HYDROLOGIC REGIMES DESCRIBED IN QUESTIONS 1-7 APPLY TO DIFFERENT AREAS IN THE UNIT** (make a rough sketch to help you decide). Use the following table to identify the appropriate class to use for the rating system if you have several HGM classes present within your wetland. NOTE: Use this table only if the class that is recommended in the second column represents 10% or more of the total area of the wetland unit being rated. If the area of the class listed in column 2 is less than 10% of the unit, classify the wetland using the class that represents more than 90% of the total area.

HGM Classes within the wetland unit being rated	HGM Class to Use in Rating
Slope + Riverine	Riverine
Slope + Depressional	Depressional
Slope + Lake-fringe	Lake-fringe
Depressional + Riverine along stream within boundary	Depressional
Depressional + Lake-fringe	Depressional
Salt Water Tidal Fringe and any other class of freshwater wetland	Treat as ESTUARINE under wetlands with special characteristics

**Exhibit 16**  
**SSDP2016-00415**  
**001269**

If you are unable still to determine which of the above criteria apply to your wetland, or you have more than 2 HGM classes within a wetland boundary, classify the wetland as **Depressional** for the rating.

<b>D Depressional and Flat Wetlands</b>		<b>Points</b>
WATER QUALITY FUNCTIONS – Indicators that wetland functions to improve water quality.		(only 1 score per box) (see p.38)
<b>D 1</b>	<b>Does the wetland have the potential to improve water quality?</b>	
D 1.1	Characteristics of surface water flows out of the wetland: <ul style="list-style-type: none"> <li>Unit is a depression with no surface water leaving it (no outlet)..... points = 3</li> <li>Unit has an intermittently flowing, OR highly constricted, permanently flowing outlet ..... points = 2</li> <li>Unit has an unconstricted, or slightly constricted, surface outlet (<i>permanently flowing</i>) ..... points = 1</li> <li>Unit is a “flat” depression (Q.7 on key), or in the Flats class, with permanent surface outflow <b>and no obvious natural outlet</b> and/or <b>outlet is a man-made ditch</b>..... points = 1 (If ditch is not permanently flowing treat unit as “intermittently flowing”) <b>Provide photo or drawing</b></li> </ul>	Figure ____ 1
D 1.2	The soil 2 inches below the surface (or duff layer) is clay or organic ( <i>use NRCS definitions</i> ) YES points = 4 NO points = 0	0
D 1.3	Characteristics of persistent vegetation (emergent, shrub, and/or forest Cowardin class): <ul style="list-style-type: none"> <li>Wetland has persistent, ungrazed vegetation &gt; = 95% of area..... points = 5</li> <li>Wetland has persistent, ungrazed vegetation &gt; = 1/2 of area..... points = 3</li> <li>Wetland has persistent, ungrazed vegetation &gt; = 1/10 of area..... points = 1</li> <li>Wetland has persistent, ungrazed vegetation &lt; 1/10 of area..... points = 0</li> </ul> Map of Cowardin vegetation classes	Figure ____ 5
D 1.4	Characteristics of seasonal ponding or inundation: <i>This is the area of the wetland that is ponded for at least 2 months, but dries out sometime during the year. Do not count the area that is permanently ponded. Estimate area as the average condition 5 out of 10 years.</i> <ul style="list-style-type: none"> <li>Area seasonally ponded is &gt; 1/2 total area of wetland ..... points = 4</li> <li>Area seasonally ponded is &gt; 1/4 total area of wetland ..... points = 2</li> <li>Area seasonally ponded is &lt; 1/4 total area of wetland ..... points = 0</li> </ul> Map of Hydroperiods	Figure ____ 0
<b>Total for D 1</b>		<i>Add the points in the boxes above</i> 6
<b>D 2</b>	<b>Does the wetland have the opportunity to improve water quality?</b>	(see p. 44)
Answer YES if you know or believe there are pollutants in groundwater or surface water coming into the wetland that would otherwise reduce water quality in streams, lakes or groundwater downgradient from the wetland? <i>Note which of the following conditions provide the sources of pollutants. A unit may have pollutants coming from several sources, but any single source would qualify as opportunity.</i> <ul style="list-style-type: none"> <li><input type="checkbox"/> Grazing in the wetland or within 150 ft</li> <li><input type="checkbox"/> Untreated stormwater discharges to wetland</li> <li><input type="checkbox"/> Tilled fields or orchards within 150 ft. of wetland</li> <li><input type="checkbox"/> A stream or culvert discharges into wetland that drains developed areas, residential areas, farmed fields, roads, or clear-cut logging</li> <li><input checked="" type="checkbox"/> Residential, urban areas, golf courses are within 150 ft. of wetland</li> <li><input type="checkbox"/> Wetland is fed by groundwater high in phosphorus or nitrogen</li> <li><input type="checkbox"/> Other _____</li> </ul> YES multiplier is 2 NO multiplier is 1		Multiplier  X2
<b>◆ TOTAL – Water Quality Functions</b> Multiply the score from D1 by D2; then <i>add score to table on p. 1</i>		12
HYDROLOGIC FUNCTIONS – Indicators that wetland unit functions to reduce flooding and stream degradation.		
<b>D 3</b>	<b>Does the wetland have the potential to reduce flooding and erosion?</b>	(see p.46)
D 3.1	Characteristics of surface water flows out of the wetland unit <ul style="list-style-type: none"> <li>Unit is a depression with no surface water leaving it (no outlet)..... points = 4</li> <li>Unit has an intermittently flowing, OR highly constricted permanently flowing outlet ..... points = 2</li> <li>Unit is a “flat” depression (Q.7 on key) or in the Flats class, with permanent surface outflow <b>and no obvious natural outlet</b> and/or <b>outlet is a man-made ditch</b>..... points = 1 (If ditch is not permanently flowing treat unit as “intermittently flowing”)</li> <li>Unit has an unconstricted, or slightly constricted, surface outlet (<i>permanently flowing</i>) ..... points = 0</li> </ul>	1
D 3.2	Depth of storage during wet periods. <i>Estimate the height of ponding above the bottom of the outlet. For units with no outlet measure from the surface of permanent water or deepest part (if dry).</i> <ul style="list-style-type: none"> <li>Marks of ponding are 3 ft. or more above the surface or bottom of the outlet ..... points = 7</li> <li>The wetland is a “headwater” wetland..... points = 5</li> <li>Marks of ponding between 2 ft. to &lt; 3 ft. from surface or bottom of outlet ..... points = 5</li> <li>Marks are at least 0.5 ft. to &lt; 2 ft. from surface or bottom of outlet ..... points = 3</li> <li>Wetland is flat (yes to Q.2 or Q.7 on key)but has small depressions on the surface that trap water points = 1</li> <li>Marks of ponding less than 0.5 ft ..... points = 0</li> </ul>	0
D 3.3	Contribution of wetland unit to storage in the watershed: <i>Estimate the ratio of the area of upstream basin contributing surface water to the wetland to the area of the wetland unit itself.</i> <ul style="list-style-type: none"> <li>The area of the basin is less than 10 times the area of unit..... points = 5</li> <li>The area of the basin is 10 to 100 times the area of the unit ..... points = 3</li> <li>The area of the basin is more than 100 times the area of the unit..... points = 0</li> <li>Entire unit is in the FLATS class ..... points = 5</li> </ul>	0
<b>Total for D 3</b>		<i>Add the points in the boxes above</i> 1

<b>D 4</b>	<p><b>Does the wetland have the <u>opportunity</u> to reduce flooding and erosion?</b></p> <p>Answer YES if the unit is in a location in the watershed where the flood storage, or reduction in water velocity, it provides helps protect downstream property and aquatic resources from flooding or excessive and/or erosive flows. Answer NO if the water coming into the wetland is controlled by a structure such as flood gate, tide gate, flap valve, reservoir etc. OR you estimate that more than 90% of the water in the wetland is from groundwater in areas where damaging groundwater flooding does not occur. <i>Note which of the following indicators of opportunity apply.</i></p> <p><input type="checkbox"/> Wetland is in a headwater of a river or stream that has flooding problems.</p> <p><input type="checkbox"/> Wetland drains to a river or stream that has flooding problems</p> <p><input type="checkbox"/> Wetland has no outlet and impounds surface runoff water that might otherwise flow into a river or stream that has flooding problems</p> <p><input type="checkbox"/> Other _____</p> <p>YES multiplier is 2      NO multiplier is 1</p>	<p>(see p. 49)</p> <p>Multiplier</p> <p>X1</p>
◆	<p><b>TOTAL – Hydrologic Functions</b>      Multiply the score from D3 by D4; then <i>add score to table on p. 1</i></p>	<p>1</p>

Comments:





<p><i>These questions apply to wetlands of all HGM classes.</i></p> <p>HABITAT FUNCTIONS – Indicators that wetland functions to provide important habitat.</p>		<p><b>Points</b> (only 1 score per box)</p>
<b>H 1</b>	<b>Does the wetland have the potential to provide habitat for many species?</b>	
H 1.1	<p><u>Vegetation structure</u> (see P. 72): Check the types of vegetation classes present (as defined by Cowardin) – Size threshold for each class is 1/4 acre or more than 10% of the area if unit is smaller than 2.5 acres.</p> <p><input type="checkbox"/> Aquatic Bed <input checked="" type="checkbox"/> Emergent plants <input checked="" type="checkbox"/> Scrub/shrub (areas where shrubs have &gt; 30% cover) <input type="checkbox"/> Forested (areas where trees have &gt; 30% cover)</p> <p>If the unit has a forested class check if: <input type="checkbox"/> The forested class has 3 out of 5 strata (canopy, sub-canopy, shrubs, herbaceous, moss/ground-cover) that each cover 20% within the forested polygon. Add the number of vegetation types that qualify. If you have:</p> <p style="text-align: right;"> <b>Map of Cowardin vegetation classes</b>                      4 structures or more..... points = 4                      3 structures..... points = 2                      2 structures..... points = 1                      1 structure..... points = 0                 </p>	<p><b>Figure</b> ____</p> <p style="text-align: right;">1</p>
H 1.2	<p><u>Hydroperiods</u> (see p.73): Check the types of water regimes (hydroperiods) present within the wetland. The water regime has to cover more than 10% of the wetland or 1/4 acre to count (see text for descriptions of hydroperiods).</p> <p><input type="checkbox"/> Permanently flooded or inundated <input type="checkbox"/> Seasonally flooded or inundated <input checked="" type="checkbox"/> Occasionally flooded or inundated <input checked="" type="checkbox"/> Saturated only</p> <p><input type="checkbox"/> Permanently flowing stream or river in, or adjacent to, the wetland <input type="checkbox"/> Seasonally flowing stream in, or adjacent to, the wetland <input type="checkbox"/> <b>Lake-fringe wetland..... = 2 points</b> <input type="checkbox"/> <b>Freshwater tidal wetland..... = 2 points</b></p> <p style="text-align: right;"> <b>Map of hydroperiods</b>                      4 or more types present points = 3                      3 or more types present..... points = 2                      2 types present..... points = 1                      1 type present ..... points = 0                 </p>	<p><b>Figure</b> ____</p> <p style="text-align: right;">1</p>
H 1.3	<p><u>Richness of Plant Species</u> (see p. 75): Count the number of plant species in the wetland that cover at least 10 ft<sup>2</sup> (different patches of the same species can be combined to meet the size threshold) You do not have to name the species. Do not include Eurasian Milfoil, reed canarygrass, purple loosestrife, Canadian Thistle.</p> <p>If you counted: &gt; 19 species ..... points = 2 5 – 19 species..... points = 1 &lt; 5 species ..... points = 0</p> <p>List species below if you want to:</p> <p>_____</p> <p>_____</p> <p>_____</p>	<p style="text-align: right;">1</p>
H 1.4	<p><u>Interspersion of Habitats</u> (see p. 76): Decided from the diagrams below whether interspersion between Cowardin vegetation (described in H1.1), or the classes and unvegetated areas (can include open water or mudflats) is high, medium, low, or none.</p> <div style="display: flex; justify-content: space-around;"> <div style="text-align: center;">  <p>None = 0 points</p> </div> <div style="text-align: center;">  <p>Low = 1 point</p> </div> <div style="text-align: center;">  <p>Moderate = 2 points</p> </div> </div> <div style="display: flex; justify-content: space-around; margin-top: 20px;"> <div style="text-align: center;">  <p>High = 3 points</p> </div> <div style="text-align: center;">  <p>High = 3 points</p> </div> <div style="text-align: center;">  <p>[riparian braided channels]</p> </div> </div> <p style="text-align: right;"> <b>Note:</b> If you have 4 or more classes or 3 vegetation classes and open water, the rating is always “high”.   <b>Use map of Cowardin classes.</b> </p>	<p><b>Figure</b> ____</p> <p style="text-align: right;">1</p>
H 1.5	<p><u>Special Habitat Features</u> (see p. 77): Check the habitat features that are present in the wetland. The number of checks is the number of points you put into the next column.</p> <p><input type="checkbox"/> Large, downed, woody debris within the wetland (&gt; 4 in. diameter and 6 ft. long) <input type="checkbox"/> Standing snags (diameter at the bottom &gt; 4 inches) in the wetland <input type="checkbox"/> Undercut banks are present for at least 6.6 ft. (2m) and/or overhanging vegetation extends at least 3.3 ft. (1m) over a stream (or ditch) in, or contiguous with the unit, for at least 33 ft. (10m) <input type="checkbox"/> Stable steep banks of fine material that might be used by beaver or muskrat for denning (&gt; 30 degree slope) OR signs of recent beaver activity are present (cut shrubs or trees that have not yet turned grey/brown) <input type="checkbox"/> At least 1/4 acre of thin-stemmed persistent vegetation or woody branches are present in areas that are permanently or seasonally inundated (structures for egg-laying by amphibians) <input type="checkbox"/> Invasive plants cover less than 25% of the wetland area in each stratum of plants</p> <p><i>NOTE: The 20% stated in early printings of the manual on page 78 is an error.</i></p>	<p style="text-align: right;">0</p>
<b>H 1 TOTAL Score – potential for providing habitat</b>		<p>Add the points in the column.</p> <p style="text-align: right;"><b>4</b></p>

Exhibit 16  
SSDP2016-00415  
001272

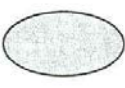
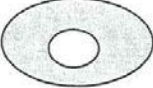

	<p>H 2.3 <u>Near or adjacent to other priority habitats listed by WDFW</u> (see p. 82): (see new and complete descriptions of WDFW priority habitats, and the counties in which they can be found, in the PHS report <a href="http://wdfw.wa.gov/hab/phslist.htm">http://wdfw.wa.gov/hab/phslist.htm</a> )</p> <p>Which of the following priority habitats are within 330 ft. (100m) of the wetland unit?  <i>NOTE: the connections do not have to be relatively undisturbed.</i></p> <p><input type="checkbox"/> <b>Aspen Stands:</b> Pure or mixed stands of aspen greater than 0.4 ha (1 acre).</p> <p><input type="checkbox"/> <b>Biodiversity Areas and Corridors:</b> Areas of habitat that are relatively important to various species of native fish and wildlife (full descriptions in WDFW PHS report p. 152).</p> <p><input type="checkbox"/> <b>Herbaceous Balds:</b> Variable size patches of grass and forbs on shallow soils over bedrock.</p> <p><input type="checkbox"/> <b>Old-growth/Mature forests:</b> (Old-growth west of Cascade crest) Stands of at least 2 tree species, forming a multi-layered canopy with occasional small openings; with at least 20 trees/ha (8 trees/acre) &gt; 81 cm (32 in) dbh or &gt; 200 years of age. (Mature forests) Stands with average diameters exceeding 53 cm (21 in) dbh; crown cover may be less than 100%; decay, decadence, numbers of snags, and quantity of large downed material is generally less than that found in old-growth; 80 - 200 years old west of the Cascade crest.</p> <p><input type="checkbox"/> <b>Oregon white Oak:</b> Woodlands Stands of pure oak or oak/conifer associations where canopy coverage of the oak component is important (full descriptions in WDFW PHS report p. 158).</p> <p><input checked="" type="checkbox"/> <b>Riparian:</b> The area adjacent to aquatic systems with flowing water that contains elements of both aquatic and terrestrial ecosystems which mutually influence each other.</p> <p><input type="checkbox"/> <b>Westside Prairies:</b> Herbaceous, non-forested plant communities that can either take the form of a dry prairie or a wet prairie (full descriptions in WDFW PHS report p. 161).</p> <p><input checked="" type="checkbox"/> <b>Instream:</b> The combination of physical, biological, and chemical processes and conditions that interact to provide functional life history requirements for instream fish and wildlife resources.</p> <p><input type="checkbox"/> <b>Nearshore:</b> Relatively undisturbed nearshore habitats. These include Coastal Nearshore, Open Coast Nearshore, and Puget Sound Nearshore. (full descriptions of habitats and the definition of relatively undisturbed are in WDFW report: pp. 167-169 and glossary in Appendix A).</p> <p><input type="checkbox"/> <b>Caves:</b> A naturally occurring cavity, recess, void, or system of interconnected passages under the earth in soils, rock, ice, or other geological formations and is large enough to contain a human.</p> <p><input type="checkbox"/> <b>Cliffs:</b> Greater than 7.6 m (25 ft) high and occurring below 5000 ft.</p> <p><input type="checkbox"/> <b>Talus:</b> Homogenous areas of rock rubble ranging in average size 0.15 - 2.0 m (0.5 - 6.5 ft), composed of basalt, andesite, and/or sedimentary rock, including riprap slides and mine tailings. May be associated with cliffs.</p> <p><input type="checkbox"/> <b>Snags and Logs:</b> Trees are considered snags if they are dead or dying and exhibit sufficient decay characteristics to enable cavity excavation/use by wildlife. Priority snags have a diameter at breast height of &gt; 51 cm (20 in) in western Washington and are &gt; 2 m (6.5 ft) in height. Priority logs are &gt; 30 cm (12 in) in diameter at the largest end, and &gt; 6 m (20 ft) long.</p> <p>If wetland has <b>3 or more</b> priority habitats = <b>4 points</b>  <b>If wetland has 2</b> priority habitats = <b>3 points</b>                  If wetland has <b>1</b> priority habitat = <b>1 point</b>                      No habitats = 0 points</p> <p>Note: All vegetated wetlands are by definition a priority habitat but are not included in this list. Nearby wetlands are addressed in question H 2.4)</p>	3
	<p>H 2.4 <u>Wetland Landscape:</u> Choose the <b>one</b> description of the landscape around the wetland that best fits (see p. 84)</p> <ul style="list-style-type: none"> <li>• There are at least 3 other wetlands within 1/2 mile, and the connections between them are relatively undisturbed (light grazing between wetlands OK, as is lake shore with some boating, but connections should NOT be bisected by paved roads, fill, fields, or other development.....points = 5</li> <li>• The wetland is Lake-fringe on a lake with little disturbance and there are 3 other lake-fringe wetlands within 1/2 mile .....points = 5</li> <li>• <b>There are at least 3 other wetlands within 1/2 mile, BUT the connections between them are disturbed.....points = 3</b></li> <li>• The wetland fringe on a lake <b>with</b> disturbance and there are 3 other lake-fringe wetlands within 1/2 mile .....points = 3</li> <li>• There is at least 1 wetland within 1/2 mile .....points = 2</li> <li>• There are no wetlands within 1/2 mile.....points = 0</li> </ul>	3
<p><b>H 2 TOTAL Score</b> – opportunity for providing habitat                      <i>Add the scores from H2.1, H2.2, H2.3, H2.4</i></p>		8
<p style="text-align: right;"><i>TOTAL for H 1 from page 8</i></p>		4
◆	<p><b>Total Score for Habitat Functions</b>                      Add the points for H 1 and H 2; then <b>record the result on p. 1</b></p>	12

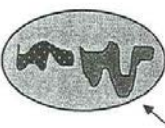
Comments:

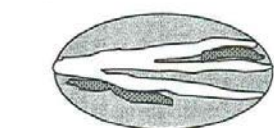



<b>SC4</b>	<p><b>Forested Wetlands</b> (see p. 90)</p> <p>Does the wetland have at least 1 acre of forest that meet one of these criteria for the Department of Fish and Wildlife's forests as priority habitats? <i>If you answer yes you will still need to rate the wetland based on its function.</i></p> <p>_____ <b>Old-growth forests:</b> (west of Cascade Crest) Stands of at least two three species forming a multi-layered canopy with occasional small openings; with at least 8 trees/acre (20 trees/hectare) that are at least 200 years of age OR have a diameter at breast height (dbh) of 32 inches (81 cm or more).</p> <p>NOTE: The criterion for dbh is based on measurements for upland forests. Two-hundred year old trees in wetlands will often have a smaller dbh because their growth rates are often slower. The DFW criterion is and "OR" so old-growth forests do not necessarily have to have trees of this diameter.</p> <p>_____ <b>Mature forests:</b> (west of the Cascade Crest) Stands where the largest trees are 80 – 200 years old OR have an average diameters (dbh) exceeding 21 inches (53 cm); crown cover may be less than 100%; decay, decadence, numbers of snags, and quantity of large downed material is generally less than that found in old-growth.</p> <p>YES = Category I                      NO = <u>X</u> not a forested wetland with special characteristics</p>	<b>Cat. I</b>
<b>SC5</b>	<p><b>Wetlands in Coastal Lagoons</b> (see p. 91)</p> <p>Does the wetland meet all of the following criteria of a wetland in a coastal lagoon?</p> <p>_____ The wetland lies in a depression adjacent to marine waters that is wholly or partially separated from marine waters by sandbanks, gravel banks, shingle, or, less frequently, rocks.</p> <p>_____ The lagoon in which the wetland is located contains surface water that is saline or brackish (&gt; 0.5 ppt) during most of the year in at least a portion of the lagoon (<i>needs to be measured near the bottom.</i>)</p> <p>YES = Go to SC 5.1                      NO <u>X</u> not a wetland in a coastal lagoon</p> <p>SC 5.1 Does the wetland meet all of the following three conditions?</p> <p>_____ The wetland is relatively undisturbed (has no diking, ditching, filling, cultivation, grazing) and has less than 20% cover of invasive plant species (see list of invasive species on p. 74).</p> <p>_____ At least 3/4 of the landward edge of the wetland has a 100 ft. buffer of shrub, forest, or un-grazed or un-mowed grassland.</p> <p>_____ The wetland is larger than 1/10 acre (4350 square ft.)</p> <p>YES = Category I                      NO = Category II</p>	<b>Cat. I</b> <b>Cat. II</b>
<b>SC6</b>	<p><b>Interdunal Wetlands</b> (see p. 93)</p> <p>Is the wetland west of the 1889 line (also called the Western Boundary of Upland Ownership or WBUO)?</p> <p>YES = Go to SC 6.1                      NO <u>X</u> not an interdunal wetland for rating</p> <p><b><i>If you answer yes you will still need to rate the wetland based on its functions.</i></b></p> <p>In practical terms that means the following geographic areas:</p> <ul style="list-style-type: none"> <li>• Long Beach Peninsula -- lands west of SR 103</li> <li>• Grayland-Westport -- lands west of SR 105</li> <li>• Ocean Shores-Copalis – lands west of SR 115 and SR 109</li> </ul> <p>SC 6.1 Is the wetland one acre or larger, or is it in a mosaic of wetlands that is one acre or larger?</p> <p>YES = Category II                      NO = go to SC 6.2</p> <p>SC 6.2 Is the wetland between 0.1 and 1 acre, or is it in a mosaic of wetlands that is between 0.1 and 1 acre?</p> <p>YES = Category III</p>	<b>Cat. II</b> <b>Cat. III</b>
◆	<p><b>Category of wetland based on Special Characteristics</b></p> <p>Choose the "highest" rating if wetland falls into several categories, and record on p. 1.</p> <p>If you answered NO for all types enter "Not Applicable" on p. 1</p>	<b>NA</b>

Comments:

**Exhibit 16**  
**SSDP2016-00415**  
**001276**

Wetland name or number 30B

**WETLAND RATING FORM – WESTERN WASHINGTON**  
Version 2 – Updated July 2006 to increase accuracy and reproducibility among users  
Updated Oct. 2008 with the new WDFW definitions for priority habitats

Name of wetland (if known): 30B Date of site visit: 09-27-13

Rated by: Colin Worsley / Matt Maynard Trained by Ecology? Yes X No      Date of training: 11-2005 / 04-2006

SEC: 29 TOWNSHIP: 25N RANGE: 06E Is S/T/R in Appendix D? Yes      No X

Map of wetland unit: Figure                      Estimated size 0.03 acre

**SUMMARY OF RATING**

Category based on FUNCTIONS provided by wetland: I      II      III X IV     

Category I =	Score > 70
Category II =	Score 51 - 69
Category III =	Score 30 – 50
Category IV =	Score < 30

Score for Water Quality Functions	22
Score for Hydrologic Functions	10
Score for Habitat Functions	14
<b>TOTAL Score for Functions</b>	<b>46</b>

Category based on SPECIAL CHARACTERISTICS of Wetland I      II      Does not apply X

**Final Category** (choose the “highest” category from above”) **III**

**Summary of basic information about the wetland unit.**

Wetland Unit has Special Characteristics		Wetland HGM Class used for Rating	
<b>Estuarine</b>		<b>Depressional</b>	<b>X</b>
<b>Natural Heritage Wetland</b>		<b>Riverine</b>	
<b>Bog</b>		<b>Lake-fringe</b>	
<b>Mature Forest</b>		<b>Slope</b>	(x)
<b>Old Growth Forest</b>		<b>Flats</b>	
<b>Coastal Lagoon</b>		<b>Freshwater Tidal</b>	
<b>Interdunal</b>			
None of the above	X	Check if unit has multiple HGM classes present	<b>X</b>

**Does the wetland being rated meet any of the criteria below?** If you answer YES to any of the questions below you will need to protect the wetland according to the regulations regarding the special characteristics found in the wetland.

Check List for Wetlands that Need Additional Protection (in addition to the protection recommended for its category)		YES	NO
SP1. <i>Has the wetland unit been documented as a habitat for any Federally listed Threatened or Endangered <b>animal or plant</b> species (T/E species)?</i> For the purposes of this rating system, “documented” means the wetland is on the appropriate state or federal database.			X
SP2. <i>Has the wetland unit been documented as habitat for any State listed Threatened or Endangered <b>animal</b> species?</i> For the purposes of this rating system, “documented” means the wetland is on the appropriate state database. Note: Wetlands with State listed plant species are categorized as Category 1 Natural Heritage Wetlands (see p. 19 of data form).			X
SP3. <i>Does the wetland unit contain individuals of Priority species listed by the WDFW for the state?</i>			X
SP4. <i>Does the wetland unit have a local significance in addition to its functions?</i> For example, the wetland has been identified in the Shoreline Master Program, the Critical Areas Ordinance, or in a local management plan as having special significance.			X

To complete the next part of the data sheet you will need to determine the Hydrogeomorphic Class of the wetland being rated.

Exhibit 16  
SSDP2016-00415  
001297

### Classification of Vegetated Wetlands for Western Washington

If the hydrologic criteria listed in each question do not apply to the entire unit being rated, you probably have a unit with multiple HGM classes. In this case, identify which hydrologic criteria in questions 1-7 apply, and go to Question 8.

1. Are the water levels in the entire unit usually controlled by tides (i.e. except during floods)?  
NO – go to 2                      **YES – the wetland class is Tidal Fringe**  
 If yes, is the salinity of the water during periods of annual low flow below 0.5 ppt (parts per thousand)?  
**YES – Freshwater Tidal Fringe**                      **NO – Saltwater Tidal Fringe (Estuarine)**  
*If your wetland can be classified as a Freshwater Tidal Fringe use the forms for Riverine wetlands. If it is a Saltwater Tidal Fringe it is rated as an Estuarine wetland. Wetlands that were call estuarine in the first and second editions of the rating system are called Salt Water Tidal Fringe in the Hydrogeomorphic Classification. Estuarine wetlands were categorized separately in the earlier editions, and this separation is being kept in this revision. To maintain consistency between editions, the term “Estuarine” wetland is kept. Please note, however, that the characteristics that define Category I and II estuarine wetlands have changed (see p. \_\_\_\_).*

---

2. The entire wetland unit is flat and precipitation is only source (>90%) of water to it. Groundwater and surface water runoff are NOT sources of water to the unit.  
NO – go to 3                      **YES – The wetland class is Flats**  
 If your wetland can be classified as a “Flats” wetland, use the form for **Depressional** wetlands.

---

3. Does the entire wetland meet both of the following criteria?  
 \_\_\_\_\_ The vegetated part of the wetland is on the shores of a body of permanent open water (without any vegetation on the surface) where at least 20 acres (8ha) in size;  
 \_\_\_\_\_ At least 30% of the open water area is deeper than 6.6 (2 m)?  
NO – go to 4                      **YES – The wetland class is Lake-fringe (Lacustrine Fringe)**

---

4. Does the entire wetland meet all of the following criteria?  
 \_\_\_\_\_ The wetland is on a slope (*slope can be very gradual*).  
 \_\_\_\_\_ The water flows through the wetland in one direction (unidirectional) and usually comes from seeps. It may flow subsurface, as sheetflow, or in a swale without distinct banks.  
 \_\_\_\_\_ The water leaves the wetland **without being impounded**?  
 NOTE: *Surface water does not pond in these types of wetlands except occasionally in very small and shallow depressions or behind hummocks (depressions are usually <3 ft diameter and less than 1 foot deep).*  
NO – go to 5                      **YES – The wetland class is Slope**

---

5. Does the entire wetland meet all of the following criteria?  
 \_\_\_\_\_ The unit is in a valley or stream channel where it gets inundated by overbank flooding from that stream or river.  
 \_\_\_\_\_ The overbank flooding occurs at least once every two years.  
 NOTE: *The riverine unit can contain depressions that are filled with water when the river is not flooding..*  
NO – go to 6                      **YES – The wetland class is Riverine**

---

6. Is the entire wetland unit in a topographic depression in which water ponds, or is saturated to the surface, at some time of the year. This means that any outlet, if present is higher than the interior of the wetland.  
NO – go to 7                      **YES – The wetland class is Depressional**

---

7. Is the entire wetland located in a very flat area with no obvious depression and no overbank flooding. The unit does not pond surface water more than a few inches. The unit seems to be maintained by high groundwater in the area. The wetland may be ditched, but has no obvious natural outlet.  
No – go to 8                      **YES – The wetland class is Depressional**

---

8. Your wetland unit seems to be difficult to classify and probably contains several different HGM classes. For example, seeps at the base of a slope may grade into a riverine floodplain, or a small stream within a depressional wetland has a zone of flooding along its sides. **GO BACK AND IDENTIFY WHICH OF THE HYDROLOGIC REGIMES DESCRIBED IN QUESTIONS 1-7 APPLY TO DIFFERENT AREAS IN THE UNIT** (make a rough sketch to help you decide). Use the following table to identify the appropriate class to use for the rating system if you have several HGM classes present within your wetland. NOTE: Use this table only if the class that is recommended in the second column represents 10% or more of the total area of the wetland unit being rated. If the area of the class listed in column 2 is less than 10% of the unit, classify the wetland using the class that represents more than 90% of the total area.

HGM Classes within the wetland unit being rated	HGM Class to Use in Rating
Slope + Riverine	Riverine
Slope + Depressional	Depressional
Slope + Lake-fringe	Lake-fringe
Depressional + Riverine along stream within boundary	Depressional
Depressional + Lake-fringe	Depressional
Salt Water Tidal Fringe and any other class of freshwater wetland	Treat as ESTUARINE under wetlands with special characteristics

**Exhibit 16**  
**SSDP2016-00415**  
**001278**

If you are unable still to determine which of the above criteria apply to your wetland, or you have more than 2 HGM classes within a wetland boundary, classify the wetland as **Depressional** for the rating.



<b>D 4</b>	<p><b>Does the wetland have the <u>opportunity</u> to reduce flooding and erosion?</b></p> <p>Answer YES if the unit is in a location in the watershed where the flood storage, or reduction in water velocity, it provides helps protect downstream property and aquatic resources from flooding or excessive and/or erosive flows. Answer NO if the water coming into the wetland is controlled by a structure such as flood gate, tide gate, flap valve, reservoir etc. OR you estimate that more than 90% of the water in the wetland is from groundwater in areas where damaging groundwater flooding does not occur. <i>Note which of the following indicators of opportunity apply.</i></p> <p><input type="checkbox"/> Wetland is in a headwater of a river or stream that has flooding problems.</p> <p><input type="checkbox"/> Wetland drains to a river or stream that has flooding problems</p> <p><input type="checkbox"/> Wetland has no outlet and impounds surface runoff water that might otherwise flow into a river or stream that has flooding problems</p> <p><input type="checkbox"/> Other _____</p> <p><b>YES multiplier is 2</b>                      NO multiplier is 1</p>	<p>(see p. 49)</p> <p>Multiplier</p> <p><u>X1</u></p>
◆	<p><b>TOTAL – Hydrologic Functions</b>                      Multiply the score from D3 by D4; then <i>add score to table on p. 1</i></p>	<p><b>10</b></p>

Comments:





<p><i>These questions apply to wetlands of all HGM classes.</i></p> <p>HABITAT FUNCTIONS – Indicators that wetland functions to provide important habitat.</p>		<p><b>Points</b> (only 1 score per box)</p>
<b>H 1</b>	<b>Does the wetland have the <u>potential</u> to provide habitat for many species?</b>	
	<p>H 1.1 <u>Vegetation structure</u> (see P. 72):                      Check the types of vegetation classes present (as defined by Cowardin) – Size threshold for each class is 1/4 acre or more than 10% of the area if unit is smaller than 2.5 acres.</p> <p><input type="checkbox"/> Aquatic Bed  <input type="checkbox"/> Emergent plants  <input type="checkbox"/> Scrub/shrub (areas where shrubs have &gt; 30% cover)  <input checked="" type="checkbox"/> Forested (areas where trees have &gt; 30% cover)                      If the unit has a forested class check if:  <input checked="" type="checkbox"/> The forested class has 3 out of 5 strata (canopy, sub-canopy, shrubs, herbaceous, moss/ground-cover) that each cover 20% within the forested polygon.                      Add the number of vegetation types that qualify. If you have:</p> <p style="text-align: right;"> <b>Map of Cowardin vegetation classes</b>                      4 structures or more..... points = 4                      3 structures..... points = 2                      2 structures..... points = 1                      1 structure..... points = 0                 </p>	<p><b>Figure</b> ____</p> <p style="text-align: right;">1</p>
	<p>H 1.2 <u>Hydroperiods</u> (see p.73):                      Check the types of water regimes (hydroperiods) present within the wetland. The water regime has to cover more than 10% of the wetland or 1/4 acre to count (see text for descriptions of hydroperiods).</p> <p><input type="checkbox"/> Permanently flooded or inundated  <input checked="" type="checkbox"/> Seasonally flooded or inundated  <input type="checkbox"/> Occasionally flooded or inundated  <input checked="" type="checkbox"/> Saturated only  <input checked="" type="checkbox"/> Permanently flowing stream or river in, or adjacent to, the wetland  <input type="checkbox"/> Seasonally flowing stream in, or adjacent to, the wetland  <input type="checkbox"/> <b>Lake-fringe wetland..... = 2 points</b>  <input type="checkbox"/> <b>Freshwater tidal wetland..... = 2 points</b></p> <p style="text-align: right;"> <b>Map of hydroperiods</b>                      4 or more types present points = 3                      3 or more types present..... points = 2                      2 types present..... points = 1                      1 type present..... points = 0                 </p>	<p><b>Figure</b> ____</p> <p style="text-align: right;">2</p>
	<p>H 1.3 <u>Richness of Plant Species</u> (see p. 75):                      Count the number of plant species in the wetland that cover at least 10 ft<sup>2</sup> (different patches of the same species can be combined to meet the size threshold)                      You do not have to name the species. Do not include Eurasian Milfoil, reed canarygrass, purple loosestrife, Canadian Thistle.                      If you counted: &gt; 19 species ..... points = 2                      5 – 19 species..... points = 1                      &lt; 5 species ..... points = 0</p> <p>List species below if you want to:</p> <p>_____</p> <p>_____</p> <p>_____</p>	<p><b>Figure</b> ____</p> <p style="text-align: right;">1</p>
	<p>H 1.4 <u>Interspersion of Habitats</u> (see p. 76):                      Decided from the diagrams below whether interspersion between Cowardin vegetation (described in H1.1), or the classes and unvegetated areas (can include open water or mudflats) is high, medium, low, or none.</p> <div style="display: flex; justify-content: space-around;"> <div style="text-align: center;">  <p>None = 0 points</p> </div> <div style="text-align: center;">  <p>Low = 1 point</p> </div> <div style="text-align: center;">  <p>Moderate = 2 points</p> </div> <div style="text-align: center;">  </div> </div> <div style="display: flex; justify-content: space-around; margin-top: 20px;"> <div style="text-align: center;">  </div> <div style="text-align: center;">  <p>High = 3 points</p> </div> <div style="text-align: center;">  <p>[riparian braided channels]</p> </div> </div> <p style="text-align: right;"> <b>Note:</b> If you have 4 or more classes or 3 vegetation classes and open water, the rating is always “high”.   <b>Use map of Cowardin classes.</b> </p>	<p><b>Figure</b> ____</p> <p style="text-align: right;">0</p>
	<p>H 1.5 <u>Special Habitat Features</u> (see p. 77):                      Check the habitat features that are present in the wetland. The number of checks is the number of points you put into the next column.</p> <p><input checked="" type="checkbox"/> Large, downed, woody debris within the wetland (&gt; 4 in. diameter and 6 ft. long)  <input type="checkbox"/> Standing snags (diameter at the bottom &gt; 4 inches) in the wetland  <input type="checkbox"/> Undercut banks are present for at least 6.6 ft. (2m) and/or overhanging vegetation extends at least 3.3 ft. (1m) over a stream (or ditch) in, or contiguous with the unit, for at least 33 ft. (10m)  <input type="checkbox"/> Stable steep banks of fine material that might be used by beaver or muskrat for denning (&gt; 30 degree slope) OR signs of recent beaver activity are present (cut shrubs or trees that have not yet turned grey/brown)  <input type="checkbox"/> At least 1/4 acre of thin-stemmed persistent vegetation or woody branches are present in areas that are permanently or seasonally inundated (structures for egg-laying by amphibians)  <input type="checkbox"/> Invasive plants cover less than 25% of the wetland area in each stratum of plants</p> <p><i>NOTE: The 20% stated in early printings of the manual on page 78 is an error.</i></p>	<p><b>Figure</b> ____</p> <p style="text-align: right;">1</p>
<p><b>H 1 TOTAL Score</b> – potential for providing habitat</p>		<p>Add the points in the column</p> <p style="text-align: right;"><b>5</b></p>

Exhibit 16  
SSDP2016-00415  
001281

<b>H 2</b>	<b>Does the wetland have the opportunity to provide habitat for many species?</b>	(only 1 score per box)
	<p><b>H 2.1 Buffers</b> (see P. 80):  <i>Choose the description that best represents condition of buffer of wetland unit. The highest scoring criterion that applies to the wetland is to be used in the rating. See text for definition of "undisturbed".</i></p> <p><input type="checkbox"/> 100m (330 ft) of relatively undisturbed vegetated areas, rocky areas, or open water &gt; 95% of circumference. No structures are within the undisturbed part of buffer (relatively undisturbed also means no grazing, no landscaping, no daily human use)..... <b>points = 5</b></p> <p><input type="checkbox"/> 100m (330 ft) of relatively undisturbed vegetated areas, rocky areas, or open water &gt; 50% circumference ..... <b>points = 4</b></p> <p><input type="checkbox"/> 50m (170 ft) of relatively undisturbed vegetated areas, rocky areas, or open water &gt; 95% circumference ..... <b>points = 4</b></p> <p><input type="checkbox"/> 100m (330 ft) of relatively undisturbed vegetated areas, rocky areas, or open water &gt; 25% circumference ..... <b>points = 3</b></p> <p><input type="checkbox"/> 50m (170 ft) of relatively undisturbed vegetated areas, rocky areas, or open water for &gt; 50% circumference ..... <b>points = 3</b></p> <p><b>If buffer does not meet any of the criteria above:</b></p> <p><input type="checkbox"/> No paved areas (except paved trails) or buildings within 25m (80 ft) of wetland &gt; 95% circumference. Light to moderate grazing or lawns are OK ..... <b>points = 2</b></p> <p><input type="checkbox"/> No paved areas of buildings within 50m of wetland for &gt; 50% circumference. Light to moderate grazing or lawns are OK..... <b>points = 2</b></p> <p><input type="checkbox"/> Heavy grazing in buffer ..... <b>points = 1</b></p> <p><input type="checkbox"/> Vegetated buffers are &lt; 2m wide (6.6 ft) for more than 95% circumference (e.g. tilled fields, paving, basalt bedrock extend to edge of wetland) ..... <b>points = 0</b></p> <p><input checked="" type="checkbox"/> Buffer does not meet any of the criteria above ..... <b>points = 1</b></p> <p style="text-align: right;"><b>Arial photo showing buffers</b></p>	<p><b>Figure</b> _____</p> <p style="text-align: center;">1</p>
	<p><b>H 2.2 Corridors and Connections</b> (see p. 81)</p> <p>H 2.2.1 Is the wetland part of a relatively undisturbed and unbroken vegetated corridor (either riparian or upland) that is at least 150 ft. wide, has at least a 30% cover of shrubs, forest or native undisturbed prairie, that connects to estuaries, other wetlands or undisturbed uplands that are at least 250 acres in size? (<i>Dams in riparian corridors, heavily used gravel roads, paved roads, are considered breaks in the corridor.</i>)</p> <p style="text-align: center;">YES = <b>4 points</b> (go to H 2.3)                      NO = go to H 2.2.2</p> <p>H. 2.2.2 Is the wetland part of a relatively undisturbed and unbroken vegetated corridor (either riparian or upland) that is at least 50 ft. wide, has at least 30% cover of shrubs or forest, and connects to estuaries, other wetlands or undisturbed uplands that are at least 25 acres in size? <b>OR a Lake-fringe</b> wetland, if it does not have an undisturbed corridor as in the question above?</p> <p style="text-align: center;">YES = <b>2 points</b> (go to H 2.3)                      NO = go to H 2.2.3</p> <p>H. 2.2.3 Is the wetland:</p> <ul style="list-style-type: none"> <li>• Within 5 mi (8km) of a brackish or salt water estuary OR</li> <li>• Within 3 miles of a large field or pasture (&gt; 40 acres) OR                      YES = 1 point</li> <li>• Within 1 mile of a lake greater than 20 acres?                      NO = 0 points</li> </ul>	<p style="text-align: center;">1</p>

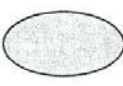
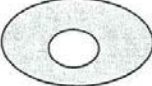
**Comments:**

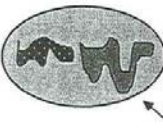
	<p>H 2.3 <u>Near or adjacent to other priority habitats listed by WDFW</u> (see p. 82): (see new and complete descriptions of WDFW priority habitats, and the counties in which they can be found, in the PHS report <a href="http://wdfw.wa.gov/hab/phslist.htm">http://wdfw.wa.gov/hab/phslist.htm</a> )</p> <p>Which of the following priority habitats are within 330 ft. (100m) of the wetland unit?  <i>NOTE: the connections do not have to be relatively undisturbed.</i></p> <p><input type="checkbox"/> <b>Aspen Stands:</b> Pure or mixed stands of aspen greater than 0.4 ha (1 acre).</p> <p><input type="checkbox"/> <b>Biodiversity Areas and Corridors:</b> Areas of habitat that are relatively important to various species of native fish and wildlife (full descriptions in WDFW PHS report p. 152).</p> <p><input type="checkbox"/> <b>Herbaceous Balds:</b> Variable size patches of grass and forbs on shallow soils over bedrock.</p> <p><input type="checkbox"/> <b>Old-growth/Mature forests:</b> (Old-growth west of Cascade crest) Stands of at least 2 tree species, forming a multi-layered canopy with occasional small openings; with at least 20 trees/ha (8 trees/acre) &gt; 81 cm (32 in) dbh or &gt; 200 years of age. (Mature forests) Stands with average diameters exceeding 53 cm (21 in) dbh; crown cover may be less than 100%; decay, decadence, numbers of snags, and quantity of large downed material is generally less than that found in old-growth; 80 - 200 years old west of the Cascade crest.</p> <p><input type="checkbox"/> <b>Oregon white Oak:</b> Woodlands Stands of pure oak or oak/conifer associations where canopy coverage of the oak component is important (full descriptions in WDFW PHS report p. 158).</p> <p><input checked="" type="checkbox"/> <b>Riparian:</b> The area adjacent to aquatic systems with flowing water that contains elements of both aquatic and terrestrial ecosystems which mutually influence each other.</p> <p><input type="checkbox"/> <b>Westside Prairies:</b> Herbaceous, non-forested plant communities that can either take the form of a dry prairie or a wet prairie (full descriptions in WDFW PHS report p. 161).</p> <p><input checked="" type="checkbox"/> <b>Instream:</b> The combination of physical, biological, and chemical processes and conditions that interact to provide functional life history requirements for instream fish and wildlife resources.</p> <p><input type="checkbox"/> <b>Nearshore:</b> Relatively undisturbed nearshore habitats. These include Coastal Nearshore, Open Coast Nearshore, and Puget Sound Nearshore. (full descriptions of habitats and the definition of relatively undisturbed are in WDFW report: pp. 167-169 and glossary in Appendix A).</p> <p><input type="checkbox"/> <b>Caves:</b> A naturally occurring cavity, recess, void, or system of interconnected passages under the earth in soils, rock, ice, or other geological formations and is large enough to contain a human.</p> <p><input type="checkbox"/> <b>Cliffs:</b> Greater than 7.6 m (25 ft) high and occurring below 5000 ft.</p> <p><input type="checkbox"/> <b>Talus:</b> Homogenous areas of rock rubble ranging in average size 0.15 - 2.0 m (0.5 - 6.5 ft), composed of basalt, andesite, and/or sedimentary rock, including riprap slides and mine tailings. May be associated with cliffs.</p> <p><input checked="" type="checkbox"/> <b>Snags and Logs:</b> Trees are considered snags if they are dead or dying and exhibit sufficient decay characteristics to enable cavity excavation/use by wildlife. Priority snags have a diameter at breast height of &gt; 51 cm (20 in) in western Washington and are &gt; 2 m (6.5 ft) in height. Priority logs are &gt; 30 cm (12 in) in diameter at the largest end, and &gt; 6 m (20 ft) long.</p> <p style="background-color: yellow;">If wetland has <b>3 or more</b> priority habitats = <b>4 points</b></p> <p>If wetland has <b>2</b> priority habitats = <b>3 points</b></p> <p>If wetland has <b>1</b> priority habitat = <b>1 point</b>                      No habitats = 0 points</p> <p>Note: All vegetated wetlands are by definition a priority habitat but are not included in this list. Nearby wetlands are addressed in question H 2.4)</p>	4
	<p>H 2.4 <u>Wetland Landscape:</u> Choose the <b>one</b> description of the landscape around the wetland that best fits (see p. 84)</p> <ul style="list-style-type: none"> <li>• There are at least 3 other wetlands within 1/2 mile, and the connections between them are relatively undisturbed (light grazing between wetlands OK, as is lake shore with some boating, but connections should NOT be bisected by paved roads, fill, fields, or other development.....points = 5</li> <li>• The wetland is Lake-fringe on a lake with little disturbance and there are 3 other lake-fringe wetlands within 1/2 mile .....points = 5</li> <li style="background-color: yellow;">• There are at least 3 other wetlands within 1/2 mile, BUT the connections between them are disturbed.....points = 3</li> <li>• The wetland fringe on a lake <b>with</b> disturbance and there are 3 other lake-fringe wetlands within 1/2 mile .....points = 3</li> <li>• There is at least 1 wetland within 1/2 mile .....points = 2</li> <li>• There are no wetlands within 1/2 mile.....points = 0</li> </ul>	3
	<p><b>H 2 TOTAL Score</b> – opportunity for providing habitat                      Add the scores from H2.1, H2.2, H2.3, H2.4</p>	9
	<p style="text-align: right;">TOTAL for H 1 from page 8</p>	5
◆	<p><b>Total Score for Habitat Functions</b>                      Add the points for H 1 and H 2; then <b>record the result on p. 1</b></p>	14

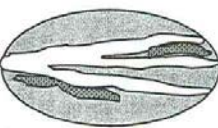
Comments:



## CATEGORIZATION BASED ON SPECIAL CHARACTERISTICS

*Please determine if the wetland meets the attributes described below  
and circle the appropriate answers and Category.*

<b>Wetland Type</b> – Check off any criteria that apply to the wetland. Circle the Category when the appropriate criteria are met.		
<b>SC1</b>	<p><b>Estuarine wetlands?</b> (see p.86)</p> <p>Does the wetland unit meet the following criteria for Estuarine wetlands?</p> <p><input type="checkbox"/> The dominant water regime is tidal,</p> <p><input type="checkbox"/> Vegetated, and</p> <p><input type="checkbox"/> With a salinity greater than 0.5 ppt.</p> <p style="text-align: center;">YES = Go to SC 1.1                      NO <u>  X  </u></p>	
SC 1.1	<p>Is the wetland unit within a National Wildlife Refuge, National Park, National Estuary Reserve, Natural Area Preserve, State Park or Educational, Environmental, or Scientific Reserve designated under WAC 332-30-151?    YES = Category I                      NO = go to SC 1.2</p>	<b>Cat. I</b>
SC 1.2	<p>Is the wetland at least 1 acre in size and meets at least two of the following conditions?</p> <p style="text-align: center;">YES = Category I                      NO = Category II</p> <p><input type="checkbox"/> The wetland is relatively undisturbed (has no diking, ditching, filling, cultivation, grazing, and has less than 10% cover of non-native plant species. If the non-native <i>Spartina</i> spp., are only species that cover more than 10% of the wetland, then the wetland should be given a dual rating (I/II). The area of <i>Spartina</i> would be rated a Category II while the relatively undisturbed upper marsh with native species would be a Category I. Do not, however, exclude the area of <i>Spartina</i> in determining the size threshold of 1 acre.</p> <p><input type="checkbox"/> At least 3/4 of the landward edge of the wetland has a 100 ft. buffer of shrub, forest, or un-grazed or un-mowed grassland</p> <p><input type="checkbox"/> The wetland has at least 2 of the following features: tidal channels, depressions with open water, or contiguous freshwater wetlands.</p>	<b>Cat. I</b>  <b>Cat. II</b>  <b>Dual Rating I/II</b>
<b>SC2</b>	<p><b>Natural Heritage Wetlands</b> (see p. 87)</p> <p>Natural Heritage wetlands have been identified by the Washington Natural Heritage Program/DNR as either high quality undisturbed wetlands or wetlands that support state Threatened, Endangered, or Sensitive plant species.</p> <p>SC 2.1 Is the wetland being rated in a Section/Township/Range that contains a natural heritage wetland? (<i>This question is used to screen out most sites before you need to contact WNHP/DNR.</i>)</p> <p style="text-align: center;">S/T/R information from Appendix D _____ or accessed from WNHP/DNR web site _____</p> <p style="text-align: center;">YES _____ Contact WNHP/DNR (see p. 79) and go to SC 2.2                      NO <u>  X  </u></p> <p>SC 2.2 Has DNR identified the wetland as a high quality undisturbed wetland or as a site with state threatened or endangered plant species?</p> <p style="text-align: center;">YES = Category 1                      NO _____ not a Heritage Wetland</p>	<b>Cat I</b>
<b>SC3</b>	<p><b>Bogs</b> (see p. 87)</p> <p>Does the wetland (<b>or any part of the unit</b>) meet both the criteria for soils and vegetation in bogs? Use the key below to identify if the wetland is a bog. <i>If you answer yes you will still need to rate the wetland based on its function.</i></p> <ol style="list-style-type: none"> <li>1. Does the unit have organic soil horizons (i.e. layers of organic soil), either peats or mucks, that compose 16 inches or more of the first 32 inches of soil profile? (See Appendix B for a field key to identify organic soils)?    YES = go to question 3                      <b>NO = go to question 2</b></li> <li>2. Does the wetland have organic soils, either peats or mucks that are less than 16 inches deep over bedrock, or an impermeable hardpan such as clay or volcanic ash, or that are floating on a lake or pond?    YES = go to question 3                      <b>NO = is not a bog for purpose of rating</b></li> <li>3. Does the unit have more than 70% cover of mosses at ground level, AND other plants, if present, consist of the “bog” species listed in Table 3 as a significant component of the vegetation (more than 30% of the total shrub and herbaceous cover consists of species in Table 3)?</li> </ol> <p style="text-align: center;">YES = Is a bog for purpose of rating                      NO = go to question 4</p> <p>NOTE: If you are uncertain about the extent of mosses in the understory you may substitute that criterion by measuring the pH of the water that seeps into a hole dug at least 16” deep. If the pH is less than 5.0 and the “bog” plant species in Table 3 are present, the wetland is a bog.</p> <ol style="list-style-type: none"> <li>4. Is the unit forested (&gt; 30% cover) with sitka spruce, subalpine fir, western red cedar, western hemlock, lodgepole pine, quaking aspen, Englemann’s spruce, or western white pine. WITH any of the species (or combination of species) on the bog species plant list in Table 3 as a significant component of the ground cover (&gt; 30% coverage of the total shrub/herbaceous cover)?</li> </ol> <p style="text-align: center;">YES = Category I                      NO = Is not a bog for purpose of rating</p>	<b>Cat. I</b>

**Exhibit 16**  
**SSDP2016-00415**  
**001284**

SC4	<p><b>Forested Wetlands</b> (see p. 90)</p> <p>Does the wetland have at least 1 acre of forest that meet one of these criteria for the Department of Fish and Wildlife's forests as priority habitats? <i>If you answer yes you will still need to rate the wetland based on its function.</i></p> <p>___ <b>Old-growth forests:</b> (west of Cascade Crest) Stands of at least two three species forming a multi-layered canopy with occasional small openings; with at least 8 trees/acre (20 trees/hectare) that are at least 200 years of age OR have a diameter at breast height (dbh) of 32 inches (81 cm or more).</p> <p>NOTE: The criterion for dbh is based on measurements for upland forests. Two-hundred year old trees in wetlands will often have a smaller dbh because their growth rates are often slower. The DFW criterion is and "OR" so old-growth forests do not necessarily have to have trees of this diameter.</p> <p>___ <b>Mature forests:</b> (west of the Cascade Crest) Stands where the largest trees are 80 – 200 years old OR have an average diameters (dbh) exceeding 21 inches (53 cm); crown cover may be less than 100%; decay, decadence, numbers of snags, and quantity of large downed material is generally less than that found in old-growth.</p> <p>YES = Category I                      NO = <u>X</u> not a forested wetland with special characteristics</p>	Cat. I
SC5	<p><b>Wetlands in Coastal Lagoons</b> (see p. 91)</p> <p>Does the wetland meet all of the following criteria of a wetland in a coastal lagoon?</p> <p>___ The wetland lies in a depression adjacent to marine waters that is wholly or partially separated from marine waters by sandbanks, gravel banks, shingle, or, less frequently, rocks.</p> <p>___ The lagoon in which the wetland is located contains surface water that is saline or brackish (&gt; 0.5 ppt) during most of the year in at least a portion of the lagoon (<i>needs to be measured near the bottom.</i>)</p> <p>YES = Go to SC 5.1                      NO <u>X</u> not a wetland in a coastal lagoon</p> <p>SC 5.1 Does the wetland meet all of the following three conditions?</p> <p>___ The wetland is relatively undisturbed (has no diking, ditching, filling, cultivation, grazing) and has less than 20% cover of invasive plant species (see list of invasive species on p. 74).</p> <p>___ At least 3/4 of the landward edge of the wetland has a 100 ft. buffer of shrub, forest, or un-grazed or un-mowed grassland.</p> <p>___ The wetland is larger than 1/10 acre (4350 square ft.)</p> <p>YES = Category I                      NO = Category II</p>	Cat. I Cat. II
SC6	<p><b>Interdunal Wetlands</b> (see p. 93)</p> <p>Is the wetland west of the 1889 line (also called the Western Boundary of Upland Ownership or WBUO)?</p> <p>YES = Go to SC 6.1                      NO <u>X</u> not an interdunal wetland for rating</p> <p><b><i>If you answer yes you will still need to rate the wetland based on its functions.</i></b></p> <p>In practical terms that means the following geographic areas:</p> <ul style="list-style-type: none"> <li>• Long Beach Peninsula -- lands west of SR 103</li> <li>• Grayland-Westport -- lands west of SR 105</li> <li>• Ocean Shores-Copalis – lands west of SR 115 and SR 109</li> </ul> <p>SC 6.1 Is the wetland one acre or larger, or is it in a mosaic of wetlands that is one acre or larger?</p> <p>YES = Category II                      NO = go to SC 6.2</p> <p>SC 6.2 Is the wetland between 0.1 and 1 acre, or is it in a mosaic of wetlands that is between 0.1 and 1 acre?</p> <p>YES = Category III</p>	Cat. II Cat. III
◆	<p><b>Category of wetland based on Special Characteristics</b></p> <p><i>Choose the "highest" rating if wetland falls into several categories, and record on p. 1.</i></p> <p>If you answered NO for all types enter "Not Applicable" on p. 1</p>	NA

Comments:

**Exhibit 16**  
**SSDP2016-00415**  
**001285**

# APPENDIX C

## Wetland Functions and Values Forms

# Wetland Functions & Values Form

Wetland I.D. 15A Project: ELST South Sammamish Segment B Assessed by: Matt Maynard

Cowardin Class: PFO/PEM Ecology Category: III Local Rating: III Wetland size: ~0.50 acre Date: 10/30/07 (rev: 03/11/14)

Function/Value	Occurrence		Rationale	Principal Function(s)	Comments
	Y	N			
Flood Flow Alteration	<b>X</b>		Wetland likely provides minimal support for this function since it is primarily lake-fringe and slope HGM classes and is unable to retain water.		Rating=Low
Sediment Removal	<b>X</b>		Wetland likely provides minimal support for this function since it is primarily lake-fringe and slope HGM classes.		Rating=Low Qualifiers: (1)
Nutrient & Toxicant Removal	<b>X</b>		Wetland likely provides minimal support for this function since it is primarily a slope HGM class.		Rating=Low Qualifiers: (1)
Erosion Control & Shoreline Stabilization	<b>X</b>		Wetland is associated with one unnamed stream (#5) and the shoreline of Lake Sammamish. However, vegetation composition and condition limits this function.		Rating=Low
Production of Organic Matter and its Export	<b>X</b>		The wetland has at least 30% cover of herbaceous vegetation, but is lake-fringe and slope HGM classes. Some organic matter may be exported via the associated unnamed stream (#5) and the shoreline of Lake Sammamish.		Rating=Low Qualifiers: (1, 6)
General Habitat Suitability	<b>X</b>		PFO and PEM Cowardin classes are present. However, the PEM class is maintained lawn. Wetland is surrounded by residential development.		Rating=Low Qualifiers: (3, 5)
Habitat for Aquatic Invertebrates	<b>X</b>		Wetland is lake-fringe and has a perennial stream flowing through it.		Rating=Low
Habitat for Amphibians	<b>X</b>		Wetland has lake-fringe HGM class and a perennial stream flowing through it.		Rating=Low
Habitat for Wetland-Associated Mammals	<b>X</b>		Wetland has lake-fringe HGM class and a perennial stream flowing through it.		Rating=Low
Habitat for Wetland-Associated Birds	<b>X</b>		Wetland has lake-fringe HGM class (Lake Sammamish).		Rating=Low
General Fish Habitat	<b>X</b>		Wetland has lake-fringe HGM class and a perennial stream flowing through it.		Rating=Low
Native Plant Richness		<b>X</b>	Multiple Cowardin classes are present. However, co-dominant plants are non-native ( <i>Phalaris arundinacea</i> ). Large trees are present on the site.		
Educational or Scientific Value		<b>X</b>	There is no nearby parking & the site has no documented scientific or educational use.		
Uniqueness and Heritage		<b>X</b>	No documented protected species or habitat; not determined significant by local jurisdiction.		

# Wetland Functions & Values Form

Wetland I.D. 15BC      Project: ELST South Sammamish Segment B      Assessed by: Erik Christensen  
 Cowardin Class: PFO/PEM      Ecology Category: IV      Local Rating: IV      Wetland size: 0.15 acre      Date: 10/31/07 (rev: 03/11/14)

Function/Value	Occurrence		Rationale	Principal Function(s)	Comments
	Y	N			
Flood Flow Alteration	<b>X</b>		Wetland contains 2 unnamed streams (#4 and #5) and has a restricted outlet through a culvert.		Rating=Low Qualifiers: (4)
Sediment Removal	<b>X</b>		Wetland has slow moving water (in streams) and dense herbaceous vegetation.		Rating=Low Qualifiers: (1, 2, 3)
Nutrient & Toxicant Removal	<b>X</b>		Wetland has slow moving water (in streams) and is vegetated with dense herbaceous vegetation.		Rating=Low Qualifiers: (1, 2, 4)
Erosion Control & Shoreline Stabilization	<b>X</b>		Wetland is associated with 2 unnamed streams (#4 and #5) and is vegetated with woody and herbaceous species.		Rating=Low Qualifiers: (1, 2, 3)
Production of Organic Matter and its Export	<b>X</b>		Wetland contains herbaceous and deciduous woody vegetation and export occurs through Unnamed Streams 4 and 5.		Rating=Low Qualifiers: (1, 5, 6)
General Habitat Suitability	<b>X</b>		PFO and PEM Cowardin classes are present. However, the PEM class is maintained lawn. Wetland is surrounded by residential development. Wetland is as swale with 2 unnamed streams (#4 and #5) in a maintained yard.		Rating=Low Qualifiers: (3, 5)
Habitat for Aquatic Invertebrates	<b>X</b>		Wetland is associated with 2 unnamed streams (#4 and #5), is densely vegetated with emergent vegetation, and has woody debris.		Rating=Low Qualifiers: (1, 4, 6)
Habitat for Amphibians	<b>X</b>		Wetland is associated with 2 unnamed streams (#4 and #5), is densely vegetated with emergent vegetation, and has woody debris.		Rating=Low Qualifiers: (1, 2, 6)
Habitat for Wetland-Associated Mammals	<b>X</b>		Wetland is sloped with 2 unnamed streams (#4 and #5) at the toe of slope. No open water present.		
Habitat for Wetland-Associated Birds	<b>X</b>		Wetland is sloped with 2 unnamed streams (#4 and #5) at the toe of slope. No open water present.		
General Fish Habitat	<b>X</b>		Associated with a potential fish-bearing water.		Rating=Low
Native Plant Richness		<b>X</b>	Wetland is in a maintained yard and dominant vegetation is <i>Phalaris arundinacea</i> .		
Educational or Scientific Value		<b>X</b>	There is no nearby parking & the site has no documented scientific or educational use.		
Uniqueness and Heritage		<b>X</b>	No documented protected species or habitat; not determined significant by local jurisdiction.		

# Wetland Functions & Values Form

Wetland I.D. 15D Project: ELST South Sammamish Segment B Assessed by: Colin Worsley  
 Cowardin Class: PEM Ecology Category: IV Local Rating: IV Wetland size: 0.05 acre Date: 05/05/09 (rev: 09/12/13)

Function/Value	Occurrence		Rationale	Principal Function(s)	Comments
	Y	N			
Flood Flow Alteration	<b>X</b>		Wetland is in a maintained ditch, has outlets at the north and south ends, and is able to retain minimal volumes of water above normal conditions during storm events.		Rating=Low Qualifiers: (2)
Sediment Removal	<b>X</b>		Wetland is permanently inundated with seasonal fluctuations, and has herbaceous vegetation.		Rating=Moderate Qualifiers: (1, 2, 3, 4, 5) Vegetation is maintained.
Nutrient & Toxicant Removal	<b>X</b>		Wetland is permanently inundated with seasonal fluctuations, and has herbaceous vegetation.		Rating=Moderate Qualifiers: (1, 2, 4) Vegetation is maintained.
Erosion Control & Shoreline Stabilization		<b>X</b>	Wetland is not associated with a watercourse or shoreline.		
Production of Organic Matter and its Export	<b>X</b>		Wetland has herbaceous vegetation, is permanently inundated, and has outlets from which organic matter is flushed.		Rating=Low Qualifiers: (1, 4, 5, 6) Vegetation is maintained.
General Habitat Suitability		<b>X</b>	Wetland is a maintained vegetated ditch along the trail surrounded by development.		
Habitat for Aquatic Invertebrates	<b>X</b>		Wetland is vegetated with herbaceous vegetation and is permanently inundated.		Rating=Moderate Qualifiers: (1, 4, 6)
Habitat for Amphibians	<b>X</b>		Wetland is vegetated with herbaceous vegetation and is permanently inundated.		Rating=Low Qualifiers: (1, 2, 6) Vegetation is maintained.
Habitat for Wetland-Associated Mammals		<b>X</b>	Wetland is a maintained vegetated ditch along the trail surrounded by development.		
Habitat for Wetland-Associated Birds		<b>X</b>	No open water component in the wetland.		
General Fish Habitat		<b>X</b>	Wetland is not associated with a fish bearing water.		
Native Plant Richness	<b>X</b>				Rating=Low
Educational or Scientific Value		<b>X</b>	There is no nearby parking & the site has no documented scientific or educational use.		
Uniqueness and Heritage		<b>X</b>	No documented protected species or habitat; not determined significant by local jurisdiction.		

# Wetland Functions & Values Form

Wetland I.D. 15E Project: ELST South Sammamish Segment B Assessed by: Colin Worsley  
 Cowardin Class: PEM Ecology Category: IV Local Rating: IV Wetland size: 0.05 acre Date: 05/05/09 (rev: 09/12/13)

Function/Value	Occurrence		Rationale	Principal Function(s)	Comments
	Y	N			
Flood Flow Alteration	<b>X</b>		Wetland is in a maintained ditch, has outlets at the north and south ends, and is able to retain minimal volumes of water above normal conditions during storm events.		Rating=Low Qualifiers: (2)
Sediment Removal	<b>X</b>		Wetland is permanently inundated with seasonal fluctuations, and has herbaceous vegetation.		Rating=Moderate Qualifiers: (1, 2, 3, 4, 5) Vegetation is maintained.
Nutrient & Toxicant Removal	<b>X</b>		Wetland is permanently inundated with seasonal fluctuations, and has herbaceous vegetation.		Rating=Moderate Qualifiers: (1, 2, 4) Vegetation is maintained.
Erosion Control & Shoreline Stabilization		<b>X</b>	Wetland is not associated with a watercourse or shoreline.		
Production of Organic Matter and its Export	<b>X</b>		Wetland has herbaceous vegetation, is permanently inundated, and has outlets from which organic matter is flushed.		Rating=Low Qualifiers: (1, 4, 5, 6) Vegetation is maintained.
General Habitat Suitability		<b>X</b>	Wetland is a maintained vegetated ditch along the trail surrounded by development.		
Habitat for Aquatic Invertebrates	<b>X</b>		Wetland is vegetated with herbaceous vegetation and is permanently inundated.		Rating=Moderate Qualifiers: (1, 4, 6)
Habitat for Amphibians	<b>X</b>		Wetland is vegetated with herbaceous vegetation and is permanently inundated.		Rating=Low Qualifiers: (1, 2, 6) Vegetation is maintained.
Habitat for Wetland-Associated Mammals		<b>X</b>	Wetland is a maintained vegetated ditch along the trail surrounded by development.		
Habitat for Wetland-Associated Birds		<b>X</b>	No open water component in the wetland.		
General Fish Habitat		<b>X</b>	Wetland is not associated with a fish bearing water.		
Native Plant Richness	<b>X</b>				Rating=Low
Educational or Scientific Value		<b>X</b>	There is no nearby parking & the site has no documented scientific or educational use.		
Uniqueness and Heritage		<b>X</b>	No documented protected species or habitat; not determined significant by local jurisdiction.		

# Wetland Functions & Values Form

Wetland I.D. 18C Project: ELST South Sammamish Segment B Assessed by: Matt Maynard

Cowardin Class: PSS Ecology Category: III Local Rating: III Wetland size: 0.02 acre Date: 10/31/07 (rev: 03/11/14)

Function/Value	Occurrence		Rationale	Principal Function(s)	Comments
	Y	N			
Flood Flow Alteration	<b>X</b>		Wetland is a small, closed depressional system and has capacity for some water detention. Woody vegetation is present. Wetland is not associated with a watercourse.		Rating=Low Qualifiers: (3, 5)
Sediment Removal	<b>X</b>		Wetland may receive some sediment from trail. Seasonal ponding occurs.		Rating=Low Qualifiers: (1, 5)
Nutrient & Toxicant Removal	<b>X</b>		This wetland may receive nutrients/ toxicants from roadway stormwater runoff and adjacent residential yards. The wetland is a closed depressional system with seasonal inundation.		Rating=Low Qualifiers: (1, 2, 4)
Erosion Control & Shoreline Stabilization		<b>X</b>	Wetland is not associated with a water course or shoreline.		
Production of Organic Matter and its Export		<b>X</b>	Dense vegetation is present in wetland, but the wetland is a closed depressional system with no outlet.		
General Habitat Suitability	<b>X</b>		Surrounding area is fragmented by residential development, East Lake Sammamish Parkway, and driveways. However, the wetland buffer is forested.		Rating=Low Qualifiers: (2)
Habitat for Aquatic Invertebrates	<b>X</b>		Seasonal inundation occurs. Woody debris is present.		Rating=Low Qualifiers: (1, 5)
Habitat for Amphibians	<b>X</b>		Seasonal inundation occurs. Wetland may provide refuge habitat for amphibians.		Rating=Low Qualifiers: (1, 3, 4)
Habitat for Wetland-Associated Mammals	<b>X</b>		Wetland does not have permanent ponding.		
Habitat for Wetland-Associated Birds	<b>X</b>		Wetland does not have permanent ponding		
General Fish Habitat		<b>X</b>	Wetland is not associated with a fish bearing water.		
Native Plant Richness	<b>X</b>				Rating=Low
Educational or Scientific Value		<b>X</b>	There is no nearby parking & the site has no documented scientific or educational use.		
Uniqueness and Heritage		<b>X</b>	No documented protected species or habitat; not determined significant by local jurisdiction.		



# Wetland Functions & Values Form

Wetland I.D. 19A Project: ELST South Sammamish Segment B Assessed by: Matt Maynard  
 Cowardin Class: PEM Ecology Category: IV Local Rating: IV Wetland size: 0.02 acre Date: 11/01/07 (rev: 09/12/13)

Function/Value	Occurrence		Rationale	Principal Function(s)	Comments
	Y	N			
Flood Flow Alteration		<b>X</b>	This wetland is a ditch with herbaceous vegetation and does not provide this function.		
Sediment Removal	<b>X</b>		Wetland may receive some sediment from trail. Seasonal ponding occurs.		Rating=Low Qualifiers: (1, 2, 3, 5)
Nutrient & Toxicant Removal	<b>X</b>		This wetland is a ditch with herbaceous vegetation. Seasonal ponding occurs in the ditch. May receive excess nutrients from surrounding residential development.		Rating=Low Qualifiers: (1, 2, 4)
Erosion Control & Shoreline Stabilization		<b>X</b>	Not associated with a water course.		
Production of Organic Matter and its Export	<b>X</b>		Dense vegetation is present in wetland and a culvert is present.		Rating=Low Qualifiers: (1, 5, 6)
General Habitat Suitability		<b>X</b>	Surrounding area is fragmented by residential development, East Lake Sammamish Parkway, and driveways.		
Habitat for Aquatic Invertebrates	<b>X</b>		Herbaceous vegetation occurs in areas of seasonal inundation.		Rating=Low Qualifiers: (1, 4, 6)
Habitat for Amphibians	<b>X</b>		Wetland may provide refuge habitat for amphibians. Wetland likely is not used for amphibian breeding.		Rating=Low Qualifiers: (1, 2, 6)
Habitat for Wetland-Associated Mammals		<b>X</b>	Wetland does not have permanent ponding.		
Habitat for Wetland-Associated Birds		<b>X</b>	Wetland does not have permanent ponding		
General Fish Habitat		<b>X</b>	Wetland is not associated with a fish bearing water.		
Native Plant Richness		<b>X</b>	Wetland is dominated by invasive species ( <i>Phalaris arundinacea</i> ).		
Educational or Scientific Value		<b>X</b>	There is no nearby parking & the site has no documented scientific or educational use.		
Uniqueness and Heritage		<b>X</b>	No documented protected species or habitat; not determined significant by local jurisdiction.		

# Wetland Functions & Values Form

Wetland I.D. 19B

Project: ELST South Sammamish Segment B

Assessed by: Matt Maynard

Cowardin Class: PSS/PEM Ecology Category: III Local Rating: III Wetland size: 0.36 acre Date: 10/31/07 (rev: 03/11/14)

Function/Value	Occurrence		Rationale	Principal Function(s)	Comments
	Y	N			
Flood Flow Alteration	<b>X</b>		Wetland likely provides minimal support for this function since it has lake-fringe and slope HGM classes.		Rating=Low
Sediment Removal		<b>X</b>	Wetland does not provide this function due to the wetland's landscape position (lake-fringe and slope), lack of surface water, mowed vegetation, and lack of sediment sources.		
Nutrient & Toxicant Removal	<b>X</b>		Wetland likely provides minimal support for this function since it is has lake-fringe and slope HGM classes.		Rating=Low Qualifiers: (1)
Erosion Control & Shoreline Stabilization	<b>X</b>		Wetland is associated with the shoreline of Lake Sammamish. However, vegetation composition and condition limits this function.		Rating=Low
Production of Organic Matter and its Export	<b>X</b>		The wetland has at least 30% cover of herbaceous vegetation, but it is mowed and the wetland has lake-fringe and slope HGM classes. Some organic matter may be exported via the shoreline of Lake Sammamish.		Rating=Low Qualifiers: (1, 6)
General Habitat Suitability	<b>X</b>		Wetland is primarily maintained lawn. However, western boundary of the wetland is lake edge.		Rating=Low Qualifiers: (3, 5)
Habitat for Aquatic Invertebrates	<b>X</b>		Wetland is lake-fringe but is covered primarily with maintained lawn.		Rating=Low
Habitat for Amphibians	<b>X</b>		Wetland is lake-fringe but is covered primarily with maintained lawn.		Rating=Low
Habitat for Wetland-Associated Mammals	<b>X</b>		Wetland is lake-fringe but is covered primarily with maintained lawn.		Rating=Low
Habitat for Wetland-Associated Birds	<b>X</b>		Wetland is lake-fringe but is covered primarily with maintained lawn.		Rating=Low
General Fish Habitat	<b>X</b>		Wetland is lake-fringe but is covered primarily with maintained lawn.		Rating=Low
Native Plant Richness		<b>X</b>	Wetland is primarily maintained lawn.		
Educational or Scientific Value		<b>X</b>	There is no nearby parking & the site has no documented scientific or educational use.		
Uniqueness and Heritage		<b>X</b>	No documented protected species or habitat; not determined significant by local jurisdiction.		

# Wetland Functions & Values Form

Wetland I.D. 20A Project: ELST South Sammamish Segment B Assessed by: Matt Maynard

Cowardin Class: PEM Ecology Category: III Local Rating: III Wetland size: 0.05 acre Date: 11/01/07 (rev: 09/12/13)

Function/Value	Occurrence		Rationale	Principal Function(s)	Comments
	Y	N			
Flood Flow Alteration	<b>X</b>		Wetland is able to retain small amounts of water during storm events.		Rating=Low
Sediment Removal	<b>X</b>		The wetland is a vegetated depressional ditch with residential development uphill.		Rating=Low Qualifiers: (1, 3, 5)
Nutrient & Toxicant Removal	<b>X</b>		The wetland is a seasonally inundated vegetated depressional ditch with residential development uphill.		Rating=Low Qualifiers: (1, 2, 4)
Erosion Control & Shoreline Stabilization		<b>X</b>	Wetland likely does not provide this function since it is not associated with a water course.		
Production of Organic Matter and its Export	<b>X</b>		The wetland has at least 30% cover of herbaceous vegetation and has an outlet for export.		Rating=Low Qualifiers: (1, 6)
General Habitat Suitability		<b>X</b>	Wetland is a vegetated ditch and is fragmented from other habitat from residential development.		
Habitat for Aquatic Invertebrates	<b>X</b>		Wetland has emergent vegetation and seasonally ponded water in the ditch.		Rating=Low Qualifiers: (1, 4, 6)
Habitat for Amphibians	<b>X</b>		Wetland has emergent vegetation and seasonally ponded water in the ditch.		Rating=Low Qualifiers: (1, 2, 6)
Habitat for Wetland-Associated Mammals		<b>X</b>	Permanent water occurs in this wetland, but not sufficient for wetland-associated mammals.		
Habitat for Wetland-Associated Birds		<b>X</b>	Permanent water occurs in this wetland, but not sufficient for wetland-associated birds (not open water).		
General Fish Habitat		<b>X</b>	Wetland is not associated with a fish bearing water.		
Native Plant Richness		<b>X</b>	Wetland is dominated by <i>Phalaris arundinacea</i> .		
Educational or Scientific Value		<b>X</b>	There is no nearby parking & the site has no documented scientific or educational use.		
Uniqueness and Heritage		<b>X</b>	No documented protected species or habitat; not determined significant by local jurisdiction.		

# Wetland Functions & Values Form

Wetland I.D. 21AC

Project: ELST South Sammamish Segment B

Assessed by: Matt Maynard

Cowardin Class: PEM

Ecology Category: III Local Rating: III Wetland size: 0.40 acre

Date: 10/31/07 (rev: 03/19/14)

Function/Value	Occurrence		Rationale	Principal Function(s)	Comments
	Y	N			
Flood Flow Alteration	X		Wetland provides minimal support for this function since it is lake-fringe and slope HGM classes.		Rating=Low
Sediment Removal		X	Wetland does not provide this function due to the wetland's landscape position (lake-fringe and slope), lack of surface water, mowed vegetation, and lack of sediment sources.		
Nutrient & Toxicant Removal	X		Wetland likely provides minimal support for this function since it is lake-fringe and slope HGM classes.		Rating=Low Qualifiers: (1)
Erosion Control & Shoreline Stabilization	X		This wetland is associated with the shoreline of Lake Sammamish. However, it is a maintained lawn.		Rating=Low
Production of Organic Matter and its Export	X		The wetland has at least 30% cover of herbaceous vegetation and slopes toward Lake Sammamish.		Rating=Low Qualifiers: (1)
General Habitat Suitability	X		Western boundary of the wetland is lake edge. The vegetation is maintained lawn. Wetland is surrounded by residential development		Rating=Low Qualifiers: (3)
Habitat for Aquatic Invertebrates	X		Wetland is lake-fringe and has a stream flowing through it. Dominated by maintained lawn.		Rating=Low
Habitat for Amphibians	X		Wetland is lake-fringe and has a stream flowing through it. Dominated by maintained lawn.		Rating=Low
Habitat for Wetland-Associated Mammals	X		Wetland is lake-fringe. Dominated by maintained lawn.		Rating=Low
Habitat for Wetland-Associated Birds	X		Wetland is lake-fringe. Dominated by maintained lawn.		Rating=Low
General Fish Habitat	X		Wetland is lake-fringe. Dominated by maintained lawn.		Rating=Low
Native Plant Richness		X	Wetland is dominated by maintained lawn.		
Educational or Scientific Value		X	There is no nearby parking & the site has no documented scientific or educational use.		
Uniqueness and Heritage		X	No documented protected species or habitat; not determined significant by local jurisdiction.		

Exhibit 16

SSDP2016-00415  
001295

# Wetland Functions & Values Form

Wetland I.D. 21B

Project: ELST South Sammamish Segment B

Assessed by: Matt Maynard

Cowardin Class: PFO/PSS

Ecology Category: III Local Rating: III Wetland size: 0.08 acre Date: 11/01/07 (rev: 09/12/13)

Function/Value	Occurrence		Rationale	Principal Function(s)	Comments
	Y	N			
Flood Flow Alteration	<b>X</b>		Wetland is vegetated with woody vegetation and the outlet is constricted by a culvert to the north.		Rating=Low Qualifiers: (4, 5)
Sediment Removal	<b>X</b>		Slow moving water and fine sediment were observed in the ditch.		Rating=Moderate Qualifiers: (1, 2, 6)
Nutrient & Toxicant Removal	<b>X</b>		Permanent inundation occurs in the ditch.		Rating=Low Qualifiers: (1, 2)
Erosion Control & Shoreline Stabilization		<b>X</b>	Wetland is not associated with a water course or shoreline.		
Production of Organic Matter and its Export	<b>X</b>		Woody plants in the wetland are deciduous and outlet is present, allowing export.		Rating=Low Qualifiers: (2)
General Habitat Suitability	<b>X</b>		PFO and PSS Cowardin classes are found in the wetland.		Rating=Low Qualifiers: (5)
Habitat for Aquatic Invertebrates	<b>X</b>		Permanent inundation occurs in the ditch.		Rating=Low Qualifiers: (1, 6)
Habitat for Amphibians	<b>X</b>		Permanent inundation occurs in the ditch.		Rating=Low Qualifiers: (1, 6)
Habitat for Wetland-Associated Mammals		<b>X</b>	Permanent ponding insufficient for wetland-associated mammals.		
Habitat for Wetland-Associated Birds		<b>X</b>	No open water component in the wetland.		
General Fish Habitat		<b>X</b>	Wetland is not associated with a fish bearing water.		
Native Plant Richness	<b>X</b>		Wetland is dominated by native species and has two Cowardin classes (PFO and PSS).		Rating=Low Qualifier: (1, 2, 3)
Educational or Scientific Value		<b>X</b>	There is no nearby parking & the site has no documented scientific or educational use.		
Uniqueness and Heritage		<b>X</b>	No documented protected species or habitat; not determined significant by local jurisdiction.		

# Wetland Functions & Values Form

Wetland I.D. 21D

Project: ELST South Sammamish Segment B

Assessed by: Matt Maynard

Cowardin Class: PEM

Ecology Category: IV Local Rating: IV Wetland size: 0.15 acre Date: 11/01/07 (rev: 09/20/13)

Function/Value	Occurrence		Rationale	Principal Function(s)	Comments
	Y	N			
Flood Flow Alteration		<b>X</b>	This wetland is a vegetated swale in a maintained yard and not likely to provide this function.		
Sediment Removal	<b>X</b>		Slow moving water and dense herbaceous vegetation is present in the swale.		Rating=Low Qualifiers: (1, 3, 5)
Nutrient & Toxicant Removal	<b>X</b>		Wetland has at least 30% cover of live dense herbaceous vegetation.		Rating=Low Qualifiers: (1, 2, 4)
Erosion Control & Shoreline Stabilization		<b>X</b>	Wetland is not associated with a water course or shoreline.		
Production of Organic Matter and its Export	<b>X</b>		Wetland has at least 30% cover of live dense herbaceous vegetation and drains to a culvert to the south (export).		Rating=Low Qualifiers: (1, 5, 6)
General Habitat Suitability	<b>X</b>		This wetland is a vegetated swale in a maintained yard fragmented from other habitats.		Rating=Low
Habitat for Aquatic Invertebrates	<b>X</b>		Permanent inundation occurs and emergent vegetation is present in the swale.		Rating=Low Qualifiers: (1, 4, 6)
Habitat for Amphibians	<b>X</b>		Wetland may provide refuge and feeding areas for amphibians, however breeding is not likely to occur due to the lack of thin stemmed or floating vegetation and sufficient water depth.		Rating=Low Qualifiers: (1, 6)
Habitat for Wetland-Associated Mammals		<b>X</b>	Permanent ponding insufficient for wetland-associated mammals.		
Habitat for Wetland-Associated Birds		<b>X</b>	No open water component in the wetland.		
General Fish Habitat		<b>X</b>	Wetland is not associated with a fish bearing water.		
Native Plant Richness		<b>X</b>	Wetland is dominated by maintained lawn.		
Educational or Scientific Value		<b>X</b>	There is no nearby parking & the site has no documented scientific or educational use.		
Uniqueness and Heritage		<b>X</b>	No documented protected species or habitat; not determined significant by local jurisdiction.		

Exhibit 16

SSDP2016-00415  
001297

# Wetland Functions & Values Form

Wetland I.D. 22AB Project: ELST South Sammamish Segment B Assessed by: Matt Maynard  
 Cowardin Class: PFO/PSS/PEM Ecology Category: III Local Rating: III Wetland size: 0.46 acre Date: 04/04/08 (rev: 09/20/13)

Function/Value	Occurrence		Rationale	Principal Function(s)	Comments
	Y	N			
Flood Flow Alteration	<b>X</b>		Wetland is densely vegetated with herbaceous and deciduous woody vegetation and is associated with an unnamed tributary. Is able to retain greater amounts of water during storm events.		Rating=Moderate Qualifiers: (4, 5)
Sediment Removal	<b>X</b>		Wetland is densely vegetated with herbaceous and deciduous woody vegetation and is associated with an unnamed tributary.		Rating=Moderate Qualifiers: (1, 2, 3)
Nutrient & Toxicant Removal	<b>X</b>		Wetland is densely vegetated with herbaceous and deciduous woody vegetation and is associated with an unnamed tributary.		Rating=Moderate Qualifiers: (1, 2, 4, 5)
Erosion Control & Shoreline Stabilization	<b>X</b>		Wetland is densely vegetated with herbaceous and deciduous woody vegetation and is associated with an unnamed tributary. Portion of wetland adjacent to stream is small.		Rating=Low Qualifiers: (1, 2, 3)
Production of Organic Matter and its Export	<b>X</b>		Wetland is densely vegetated with herbaceous & deciduous woody vegetation. Unnamed tributary & other culverts/outlets provide export.		Rating=Moderate Qualifiers: (1, 2, 5, 6)
General Habitat Suitability	<b>X</b>		Wetland has more than one Cowardin class and is associated with an unnamed tributary.		Rating=Moderate Qualifiers: (3, 5)
Habitat for Aquatic Invertebrates	<b>X</b>		Wetland is densely vegetated and has seasonal inundation.		Rating=Low Qualifiers: (1, 4, 5, 6)
Habitat for Amphibians	<b>X</b>		Wetland is densely vegetated and has seasonal inundation.		Rating=Low Qualifiers: (1, 2, 4, 6)
Habitat for Wetland-Associated Mammals		<b>X</b>	Permanent ponding does not occur.		
Habitat for Wetland-Associated Birds		<b>X</b>	Permanent ponding does not occur.		
General Fish Habitat		<b>X</b>	Wetland is not associated with a fish bearing water.		
Native Plant Richness		<b>X</b>	Although wetland has more than one Cowardin class, codominant vegetation is non-native ( <i>Phalaris arundinacea</i> ).		
Educational or Scientific Value		<b>X</b>	There is no nearby parking & the site has no documented scientific or educational use.		
Uniqueness and Heritage		<b>X</b>	No documented protected species or habitat; not determined significant by local jurisdiction.		

# Wetland Functions & Values Form

Wetland I.D. 22CD Project: ELST South Sammamish Segment B Assessed by: Erik Christensen

Cowardin Class: PSS/PEM Ecology Category: IV Local Rating: IV Wetland size: 0.16 acre Date: 11/07/07 (rev: 10/25/13)

Function/Value	Occurrence		Rationale	Principal Function(s)	Comments
	Y	N			
Flood Flow Alteration	<b>X</b>		This wetland has depressional and slope HGM classes and has capacity for some water detention.		Rating=Low
Sediment Removal	<b>X</b>		Wetland has at least 30% cover of live dense herbaceous vegetation. However, the vegetation is mowed, which may limit support for this function.		Rating=Low Qualifiers: (1, 3)
Nutrient & Toxicant Removal	<b>X</b>		Wetland has at least 30% cover of live dense herbaceous vegetation. Garden and East Lake Sammamish Parkway are upslope. Vegetation is mowed, which may limit support for this function		Rating=Low Qualifiers: (1, 4)
Erosion Control & Shoreline Stabilization		<b>X</b>	Wetland is not associated with a water course or shoreline.		
Production of Organic Matter and its Export	<b>X</b>		Wetland has at least 30% cover of live dense herbaceous vegetation. Culvert provides outlet for organic matter export.		Rating=Low Qualifiers: (1, 6)
General Habitat Suitability	<b>X</b>		Wetland is primarily a vegetated swale in a maintained yard, likely to provide minimal habitat.		Rating=Low
Habitat for Aquatic Invertebrates	<b>X</b>		This wetland has depressional and slope HGM classes with only occasional inundation in a vegetated swale in a maintained yard.		Rating=Low
Habitat for Amphibians	<b>X</b>		This wetland has depressional and slope HGM classes with only occasional inundation in a vegetated swale in a maintained yard.		Rating=Low
Habitat for Wetland-Associated Mammals		<b>X</b>	Permanent ponding does not occur.		
Habitat for Wetland-Associated Birds		<b>X</b>	Permanent ponding does not occur.		
General Fish Habitat		<b>X</b>	Wetland is not associated with a fish bearing water.		
Native Plant Richness		<b>X</b>	Wetland is dominated by maintained lawn, <i>Phalaris arundinacea</i> , and <i>Rubus armeniacus</i> .		
Educational or Scientific Value		<b>X</b>	There is no nearby parking & the site has no documented scientific or educational use.		
Uniqueness and Heritage		<b>X</b>	No documented protected species or habitat; not determined significant by local jurisdiction.		



# Wetland Functions & Values Form

Wetland I.D. 22E Project: ELST South Sammamish Segment B Assessed by: Matt Maynard/Colin Worsley

Cowardin Class: PEM Ecology Category: IV Local Rating: IV Wetland size: <0.01 acre Date: 10/25/13

Function/Value	Occurrence		Rationale	Principal Function(s)	Comments
	Y	N			
Flood Flow Alteration	<b>X</b>		Wetland is a small, closed depressional system with no surface water, has capacity for very minimal water detention.		Rating=Low Qualifiers: (3)
Sediment Removal	<b>X</b>		Wetland may receive some sediment from trail. No ponding in wetland.		Rating=Low Qualifiers: (1, 3)
Nutrient & Toxicant Removal	<b>X</b>		This wetland may receive nutrients/ toxicants from adjacent roadways and residences. The wetland is a closed depressional system.		Rating=Low Qualifiers: (1, 4)
Erosion Control & Shoreline Stabilization		<b>X</b>	Wetland is not associated with a water course or shoreline.		
Production of Organic Matter and its Export		<b>X</b>	Dense vegetation is present in wetland, but the wetland is a closed depressional system with no outlet.		
General Habitat Suitability		<b>X</b>	Wetland is a small depression adjacent to trail and residences with one Cowardin class (PEM).		
Habitat for Aquatic Invertebrates		<b>X</b>	No inundation.		
Habitat for Amphibians		<b>X</b>	No inundation.		
Habitat for Wetland-Associated Mammals		<b>X</b>	No inundation.		
Habitat for Wetland-Associated Birds		<b>X</b>	No open water component in the wetland.		
General Fish Habitat		<b>X</b>	Wetland is not associated with a fish bearing water.		
Native Plant Richness		<b>X</b>	Wetland has one Cowardin class and vegetation is co-dominated by invasive species.		
Educational or Scientific Value		<b>X</b>	There is no nearby parking & the site has no documented scientific or educational use.		
Uniqueness and Heritage		<b>X</b>	No documented protected species or habitat; not determined significant by local jurisdiction.		

# Wetland Functions & Values Form

Wetland I.D. 23A Project: ELST South Sammamish Segment B Assessed by: Erik Christensen  
 Cowardin Class: PEM Ecology Category: IV Local Rating: IV Wetland size: 0.03 acre Date: 11/07/07 (rev: 1/25/13)

Function/Value	Occurrence		Rationale	Principal Function(s)	Comments
	Y	N			
Flood Flow Alteration	<b>X</b>		Wetland likely provides minimal support for this function since it is a slope/depressional wetland with a ditch located at the toe. The wetland is dominated by herbaceous vegetation.		Rating=Low
Sediment Removal	<b>X</b>		A vegetated ditch with slow moving, seasonal water is located in the wetland.		Rating=Low Qualifiers: (1, 2, 3)
Nutrient & Toxicant Removal	<b>X</b>		A vegetated ditch with seasonal inundation is located in the wetland. Wetland receives runoff from East Lake Sammamish Parkway.		Rating=Low Qualifiers: (1, 2, 4)
Erosion Control & Shoreline Stabilization		<b>X</b>	Wetland is not associated with a shoreline.		
Production of Organic Matter and its Export	<b>X</b>		The wetland has at least 30% cover of herbaceous vegetation and has outlets for exporting organic matter.		Rating=Low Qualifiers: (1, 6)
General Habitat Suitability	<b>X</b>		The wetland is fragmented by East Lake Sammamish Parkway, residential development, and the trail. Limited connectivity to upland and Wetland 23C to the north.		Rating=Low Qualifiers: (1, 3)
Habitat for Aquatic Invertebrates	<b>X</b>		Permanent inundation and emergent vegetation occur in the ditch.		Rating=Low Qualifiers: (1, 4, 6)
Habitat for Amphibians	<b>X</b>		Permanent inundation and emergent vegetation occur in the ditch.		Rating=Low Qualifiers: (1, 2, 6)
Habitat for Wetland-Associated Mammals		<b>X</b>	Permanent inundation is limited to ditch.		
Habitat for Wetland-Associated Birds		<b>X</b>	Permanent inundation is limited to ditch.		
General Fish Habitat		<b>X</b>	Wetland is not associated with a fish bearing water.		
Native Plant Richness		<b>X</b>	Codominant vegetation is non-native ( <i>Phalaris arundinacea</i> ).		
Educational or Scientific Value		<b>X</b>	There is no nearby parking & the site has no documented scientific or educational use.		
Uniqueness and Heritage		<b>X</b>	No documented protected species or habitat; not determined significant by local jurisdiction..		

# Wetland Functions & Values Form

Wetland I.D. 23B Project: ELST South Sammamish Segment B Assessed by: M. Maynard

Cowardin Class: PSS/PEM Ecology Category: III Local Rating: III Wetland size: 0.05 acre Date: 10/31/07 (rev: 9/20/13)

Function/Value	Occurrence		Rationale	Principal Function(s)	Comments
	Y	N			
Flood Flow Alteration	X		Wetland likely provides minimal support for this function since it has lake-fringe and slope HGM classes.		Rating=Low
Sediment Removal		X	Wetland does not provide this function due to the wetland's landscape position (lake-fringe and slope), lack of surface water, and lack of sediment sources.		
Nutrient & Toxicant Removal	X		Wetland likely provides minimal support for this function since it is has lake-fringe and slope HGM classes.		Rating=Low
Erosion Control & Shoreline Stabilization	X		Wetland is associated with the shoreline of Lake Sammamish. However, vegetation composition and condition limits this function.		Rating=Low
Production of Organic Matter and its Export	X		The wetland has at least 30% cover of herbaceous vegetation and has lake-fringe and slope HGM classes. Some organic matter may be exported via the shoreline of Lake Sammamish.		Rating=Low Qualifiers: (1, 6)
General Habitat Suitability	X		Wetland is associated with Lake Sammamish.		Rating=Low Qualifiers: (3, 5)
Habitat for Aquatic Invertebrates	X		Wetland is lake-fringe but is mostly sloped with no occurrences of inundation.		Rating=Low
Habitat for Amphibians	X		Wetland is lake-fringe but is mostly sloped with no occurrences of inundation.		Rating=Low
Habitat for Wetland-Associated Mammals	X		Wetland is lake-fringe but is mostly sloped with no occurrences of inundation.		Rating=Low
Habitat for Wetland-Associated Birds	X		Wetland is lake-fringe but is mostly sloped with no occurrences of inundation.		Rating=Low
General Fish Habitat	X		Wetland is lake-fringe but is mostly sloped with no occurrences of inundation.		Rating=Low
Native Plant Richness		X	Wetland is co-dominated by invasive vegetation.		
Educational or Scientific Value		X	There is no nearby parking & the site has no documented scientific or educational use.		
Uniqueness and Heritage		X	No documented protected species or habitat; not determined significant by local jurisdiction.		

# Wetland Functions & Values Form

Wetland I.D. 23C Project: ELST South Sammamish Segment B Assessed by: Erik Christensen  
 Cowardin Class: PSS/PEM Ecology Category: III Local Rating: III Wetland size: 0.09 acre Date: 11/07/07 (rev: 9/20/13)

Function/Value	Occurrence		Rationale	Principal Function(s)	Comments
	Y	N			
Flood Flow Alteration	<b>X</b>		Wetland likely provides some water retention since it is a depression that has evidence of occasional and permanent inundation.		Rating=Low
Sediment Removal	<b>X</b>		The wetland has a vegetated depressional ditch with residential development upslope and occasional and permanent inundation.		Rating=Low Qualifiers: (1, 3, 5)
Nutrient & Toxicant Removal	<b>X</b>		The wetland has a vegetated depressional ditch with residential development upslope and occasional and permanent inundation.		Rating=Low Qualifiers: (1, 2, 4)
Erosion Control & Shoreline Stabilization		<b>X</b>	Wetland is not associated with a water course or shoreline.		
Production of Organic Matter and its Export		<b>X</b>			
General Habitat Suitability	<b>X</b>		Wetland has a vegetated depressional ditch. Surrounding areas is fragmented by residential development and roads.		Rating=Low
Habitat for Aquatic Invertebrates	<b>X</b>		Wetland has emergent vegetation and occasional and permanent ponded water in the ditch.		Rating=Low Qualifiers: (1, 4, 6)
Habitat for Amphibians	<b>X</b>		Wetland has emergent vegetation and occasional and permanent ponded water in the ditch.		Rating=Low Qualifiers: (1, 2, 6)
Habitat for Wetland-Associated Mammals		<b>X</b>	Permanent ponding is limited to ditch, insufficient for wetland-associated mammals.		
Habitat for Wetland-Associated Birds		<b>X</b>	No open water component present.		
General Fish Habitat		<b>X</b>	Wetland is not associated with a fish bearing stream.		
Native Plant Richness		<b>X</b>	Although wetland has two Cowardin classes, dominant vegetation is non-native ( <i>Phalaris arundinacea</i> and <i>Rubus armeniacus</i> ).		
Educational or Scientific Value		<b>X</b>	There is no nearby parking & the site has no documented scientific or educational use.		
Uniqueness and Heritage		<b>X</b>	No documented protected species or habitat; not determined significant by local jurisdiction..		

# Wetland Functions & Values Form

Wetland I.D. 24A Project: ELST South Sammamish Segment B Assessed by: Erik Christensen  
 Cowardin Class: PFO/PSS/PEM Ecology Category: III Local Rating: III Wetland size: 0.60 acre Date: 11/07/07 (rev: 9/20/13)

Function/Value	Occurrence		Rationale	Principal Function(s)	Comments
	Y	N			
Flood Flow Alteration	<b>X</b>		Wetland has dense woody vegetation and receives floodwater from adjacent water courses.		Rating=Moderate Qualifiers: (5, 6)
Sediment Removal	<b>X</b>		Dense herbaceous vegetation occurs in a ditch that is permanently inundated and wetland is associated with streams that likely have excess sediment input.		Rating=Low Qualifiers: (1, 3, 5)
Nutrient & Toxicant Removal	<b>X</b>		Dense herbaceous vegetation occurs in a ditch that is permanently inundated. The wetland is downslope of East Lake Sammamish Parkway.		Rating=Low Qualifiers: (1, 2, 4)
Erosion Control & Shoreline Stabilization	<b>X</b>		The wetland has PFO, PSS, and PEM Cowardin classes with two water courses flowing through it.		Rating=Moderate Qualifiers: (1, 2, 3)
Production of Organic Matter and its Export	<b>X</b>		Wetland is dominated by deciduous trees and shrubs. Export of nutrients occurs from streams running through the wetland.		Rating=High Qualifiers: (2, 3, 5, 6)
General Habitat Suitability	<b>X</b>		Diversity of plant species is high. Wetland has PFO, PSS, and PEM Cowardin classes and is connected to two streams. Standing snags are present in wetland. However, wetland is surrounded by residential development.		Rating=Moderate Qualifiers: (3, 4, 5)
Habitat for Aquatic Invertebrates	<b>X</b>		A ditch occurs in the wetland that is permanently inundated. Woody debris and litter present in wetland. Streams run through wetland.		Rating=Moderate Qualifiers: (1, 5, 6)
Habitat for Amphibians	<b>X</b>		Seasonal inundation occurs. Woody debris present in wetland. Streams run through wetland.		Rating=Low Qualifiers: (1, 4, 6)
Habitat for Wetland-Associated Mammals		<b>X</b>	Permanent ponding is limited to ditch, insufficient for wetland-associated mammals.		
Habitat for Wetland-Associated Birds		<b>X</b>	No open water component present.		
General Fish Habitat	<b>X</b>		Wetland likely provides some fish habitat because it is associated with Pine Lake Creek. Wetland has PFO, PSS, and PEM Cowardin classes that offer shade, cover, and detrital matter for the stream.		Rating=Moderate Qualifiers: (1, 4)
Native Plant Richness		<b>X</b>	Wetland has three Cowardin classes. However, non-native invasive vegetation are co-dominant ( <i>Rubus armeniacus</i> and <i>Phalaris arundinacea</i> ).		
Educational or Scientific Value		<b>X</b>	There is no nearby parking & the site has no documented scientific or educational use.		
Uniqueness and Heritage		<b>X</b>	No documented protected species or habitat; not determined significant by local jurisdiction.		

# Wetland Functions & Values Form

Wetland I.D. 24B Project: ELST South Sammamish Segment B Assessed by: M. Maynard  
 Cowardin Class: PFO/PSS Ecology Category: III Local Rating: III Wetland size: 1.75 acres Date: 11/02/07 (rev: 9/25/13)

Function/Value	Occurrence		Rationale	Principal Function(s)	Comments
	Y	N			
Flood Flow Alteration	<b>X</b>		Wetland likely provides this function since it has riverine and depressional HGM classes, has capacity for some water detention, and receives floodwater from adjacent water courses.		Rating=Moderate Qualifiers: (5, 6)
Sediment Removal	<b>X</b>		Wetland likely provides this function since it is associated with streams that likely have excess sediment input.		Rating=Moderate Qualifiers: (1, 5)
Nutrient & Toxicant Removal	<b>X</b>		Wetland likely provides this function since it is associated with streams that likely have excess nutrient and toxicant input.		Rating=Moderate Qualifiers: (1, 2)
Erosion Control & Shoreline Stabilization	<b>X</b>		The wetland has PFO and PSS Cowardin classes with two water courses flowing through it.		Rating=Moderate Qualifiers: (1, 2, 3)
Production of Organic Matter and its Export	<b>X</b>		Wetland is dominated by deciduous trees and shrubs. Inundation occurs and export of nutrients occurs from stream running through the wetland.		Rating=High Qualifiers: (2, 3, 5, 6)
General Habitat Suitability	<b>X</b>		Diversity of plant species is high. Wetland has PFO and PSS Cowardin classes. However, wetland is surrounded by residential development.		Rating=Moderate Qualifiers: (2, 3, 5, 6)
Habitat for Aquatic Invertebrates	<b>X</b>		Permanent and occasional inundation occurs. Woody debris and litter present in wetland. Streams run through wetland.		Rating=Moderate Qualifiers: (1, 5, 6)
Habitat for Amphibians	<b>X</b>		Permanent and occasional inundation occurs. Woody debris present in wetland. Stream runs through wetland.		Rating=Moderate Qualifiers: (1, 4, 6)
Habitat for Wetland-Associated Mammals	<b>X</b>		Permanent ponding is limited.		Rating=Low Qualifiers: (1, 3)
Habitat for Wetland-Associated Birds		<b>X</b>	No open water component.		
General Fish Habitat	<b>X</b>		Wetland likely provides some fish habitat because it is associated with Pine Lake Creek. Wetland has PFO and PSS Cowardin classes that offer shade, cover, and detrital matter for the stream.		Rating=Moderate Qualifiers: (1, 4)
Native Plant Richness		<b>X</b>	Wetland has three strata of vegetation and large trees. However, non-native invasive vegetation is co-dominant ( <i>Rubus armeniacus</i> ).		
Educational or Scientific Value		<b>X</b>	There is no nearby parking & the site has no documented scientific or educational use.		
Uniqueness and Heritage		<b>X</b>	No documented protected species or habitat; not determined significant by local jurisdiction.		

# Wetland Functions & Values Form

Wetland I.D. 24C Project: ELST South Sammamish Segment B Assessed by: Erik Christensen  
 Cowardin Class: PFO/PEM Ecology Category: III Local Rating: III Wetland size: 0.16 acre Date: 11/07/07 (rev: 9/25/13)

Function/Value	Occurrence		Rationale	Principal Function(s)	Comments
	Y	N			
Flood Flow Alteration	<b>X</b>		Wetland has dense woody vegetation and is associated with a water course.		Rating=Low Qualifiers: (5, 6)
Sediment Removal	<b>X</b>		Dense herbaceous vegetation occurs in a ditch that is seasonally inundated.		Rating=Low Qualifiers: (1, 3, 5)
Nutrient & Toxicant Removal	<b>X</b>		Dense herbaceous vegetation occurs in a ditch that is seasonally inundated. The wetland is downslope of East Lake Sammamish Parkway.		Rating=Low Qualifiers: (1, 2, 4)
Erosion Control & Shoreline Stabilization	<b>X</b>		The wetland has a PFO Cowardin class with a water course flowing through it.		Rating=Low Qualifiers: (1, 2, 3)
Production of Organic Matter and its Export	<b>X</b>		Wetland is dominated by deciduous trees and shrubs. Export of nutrients occurs from stream running through the wetland.		Rating=Moderate Qualifiers: (2, 3, 5, 6)
General Habitat Suitability	<b>X</b>		Diversity of plant species is high. Wetland has PFO and PEM Cowardin classes and is connected to a stream. However, wetland is surrounded by residential development.		Rating=Moderate Qualifiers: (3, 4, 5)
Habitat for Aquatic Invertebrates	<b>X</b>		A ditch occurs in the wetland that is seasonally inundated. Woody debris and litter present in wetland. Stream runs through wetland.		Rating=Moderate Qualifiers: (1, 5, 6)
Habitat for Amphibians	<b>X</b>		Seasonal inundation occurs. Woody debris present in wetland. Stream runs through wetland.		Rating=Moderate Qualifiers: (1, 4, 6)
Habitat for Wetland-Associated Mammals		<b>X</b>	No permanent inundation occurs.		
Habitat for Wetland-Associated Birds		<b>X</b>	No permanent inundation occurs.		
General Fish Habitat	<b>X</b>		Wetland is has a PFO Cowardin class that offers shade, cover, and detrital matter for the stream.		Rating=Low Qualifiers: (1, 4)
Native Plant Richness		<b>X</b>	Wetland has two Cowardin classes. However, non-native invasive vegetation is co-dominant ( <i>Rubus armeniacus</i> ).		
Educational or Scientific Value		<b>X</b>	There is no nearby parking & the site has no documented scientific or educational use.		
Uniqueness and Heritage		<b>X</b>	No documented protected species or habitat; not determined significant by local jurisdiction.		

# Wetland Functions & Values Form

Wetland I.D. 25A Project: ELST South Sammamish Segment B Assessed by: Erik Christensen

Cowardin Class: PFO Ecology Category: III Local Rating: III Wetland size: 0.25 acre Date: 11/08/07 (rev: 9/25/13)

Function/Value	Occurrence		Rationale	Principal Function(s)	Comments
	Y	N			
Flood Flow Alteration	<b>X</b>		Wetland has dense woody vegetation and is associated with a water course.		Rating=Moderate Qualifiers: (5, 6)
Sediment Removal	<b>X</b>		Slow moving water, dense herbaceous vegetation, and ponding of water occur in the wetland.		Rating=Moderate Qualifiers: (1, 2, 3, 5)
Nutrient & Toxicant Removal	<b>X</b>		Dense herbaceous vegetation seasonal ponding occur. The wetland is downslope of East Lake Sammamish Parkway.		Rating=Moderate Qualifiers: (1, 2, 4)
Erosion Control & Shoreline Stabilization	<b>X</b>		The wetland has a PFO Cowardin class with a water course flowing through it.		Rating=Moderate Qualifiers: (1, 2, 3)
Production of Organic Matter and its Export	<b>X</b>		Wetland is dominated by deciduous trees and shrubs. Export of nutrients occurs from stream running through the wetland		Rating=Moderate Qualifiers: (2, 3, 5, 6)
General Habitat Suitability	<b>X</b>		Diversity of plant species is moderate. Wetland has a PFO Cowardin class and is connected to a stream. However, wetland is surrounded by residential development.		Rating=Moderate Qualifiers: (3, 4, 5)
Habitat for Aquatic Invertebrates	<b>X</b>		Seasonal inundation occurs. Woody debris and litter present in wetland. Stream runs through wetland.		Rating=Moderate Qualifiers: (1, 5, 6)
Habitat for Amphibians	<b>X</b>		Seasonal inundation occurs. Woody debris present in wetland. Stream runs through wetland.		Rating=Moderate Qualifiers: (1, 4, 6)
Habitat for Wetland-Associated Mammals		<b>X</b>	Wetland has permanent and seasonal inundation.		Rating=Low Qualifier: (1, 3, 5)
Habitat for Wetland-Associated Birds		<b>X</b>	No open water component.		
General Fish Habitat	<b>X</b>		Wetland has a PFO Cowardin class that offers shade, cover, and detrital matter for the stream.		Rating=Moderate Qualifiers: (1, 4)
Native Plant Richness		<b>X</b>	Wetland has one Cowardin class. Non-native invasive vegetation is co-dominant ( <i>Phalaris arundinacea</i> ).		
Educational or Scientific Value		<b>X</b>	There is no nearby parking & the site has no documented scientific or educational use.		
Uniqueness and Heritage		<b>X</b>	No documented protected species or habitat; not determined significant by local jurisdiction.		



# Wetland Functions & Values Form

Wetland I.D. 25B Project: ELST South Sammamish Segment B Assessed by: Erik Christensen

Cowardin Class: PFO/PSS/PEM Ecology Category: III Local Rating: III Wetland size: 0.33 acre Date: 11/08/07 (rev: 9/25/13)

Function/Value	Occurrence		Rationale	Principal Function(s)	Comments
	Y	N			
Flood Flow Alteration	<b>X</b>		Wetland likely provides some water retention since it is a depression that has evidence of seasonal and occasional inundation.		Rating=Low
Sediment Removal	<b>X</b>		Slow moving water, dense herbaceous vegetation, and ponding of water occur in the wetland.		Rating=Moderate Qualifiers: (1, 2, 3, 5)
Nutrient & Toxicant Removal	<b>X</b>		Dense herbaceous vegetation is present and seasonal ponding occurs. Likely source is East Lake Sammamish Parkway.		Rating=Moderate Qualifiers: (1, 2, 3, 4)
Erosion Control & Shoreline Stabilization		<b>X</b>	Wetland is not associated with a water course.		
Production of Organic Matter and its Export	<b>X</b>		Wetland is dominated by deciduous trees and shrubs. Outlet to Wetland 25A provides export.		Rating=Moderate Qualifiers: (1, 2, 5, 6)
General Habitat Suitability	<b>X</b>		Diversity of plant species is moderate. Wetland has PFO, PSS, and PEM Cowardin classes. However, wetland is surrounded by residential development.		Rating=Moderate Qualifiers: (4, 5)
Habitat for Aquatic Invertebrates	<b>X</b>		Wetland hydrology has seasonal and occasional inundation.		Rating=Low Qualifiers: (1, 6)
Habitat for Amphibians	<b>X</b>		Wetland hydrology has seasonal and occasional inundation.		Rating=Low Qualifiers: (1, 6)
Habitat for Wetland-Associated Mammals		<b>X</b>	No permanent inundation occurs.		
Habitat for Wetland-Associated Birds		<b>X</b>	No permanent inundation occurs.		
General Fish Habitat		<b>X</b>	Wetland is not associated with a fish bearing water.		
Native Plant Richness		<b>X</b>	Wetland has three Cowardin classes. However, non-native invasive vegetation is also co-dominant ( <i>Phalaris arundinacea</i> ).		
Educational or Scientific Value		<b>X</b>	There is no nearby parking & the site has no documented scientific or educational use.		
Uniqueness and Heritage		<b>X</b>	No documented protected species or habitat; not determined significant by local jurisdiction.		

Exhibit 16

SSDP2016-00415  
001308

# Wetland Functions & Values Form

Wetland I.D. 25C Project: ELST South Sammamish Segment B Assessed by: Erik Christensen  
 Cowardin Class: PFO/PEM Ecology Category: III Local Rating: III Wetland size: 0.25 acre Date: 11/08/07 (rev: 9/25/13)

Function/Value	Occurrence		Rationale	Principal Function(s)	Comments
	Y	N			
Flood Flow Alteration	<b>X</b>		Wetland likely provides some water retention since it is a depression that has evidence of seasonal and occasional inundation.		Rating=Low
Sediment Removal	<b>X</b>		Dense herbaceous vegetation and ponding of water occur in the wetland.		Rating=Low Qualifiers: (1, 3, 5)
Nutrient & Toxicant Removal	<b>X</b>		Dense herbaceous vegetation is present and seasonal ponding occurs.		Rating=Low Qualifiers: (1, 2, 4)
Erosion Control & Shoreline Stabilization		<b>X</b>	Wetland is not associated with a water course.		
Production of Organic Matter and its Export	<b>X</b>		Wetland is dominated by deciduous trees and shrubs and a culvert is located at the northeast corner (export).		Rating=Low Qualifiers: (1, 2, 6)
General Habitat Suitability	<b>X</b>		Diversity of plant species is moderate. Wetland has two Cowardin classes. However, wetland is surrounded by residential development.		Rating=Moderate Qualifiers: (4, 5)
Habitat for Aquatic Invertebrates	<b>X</b>		Wetland is seasonally inundated and emergent vegetation is present.		Rating=Low Qualifiers: (1, 4, 6)
Habitat for Amphibians	<b>X</b>		Wetland is seasonally inundated. Emergent vegetation and small woody debris is present.		Rating=Low Qualifiers: (1, 4, 6)
Habitat for Wetland-Associated Mammals		<b>X</b>	No permanent inundation occurs.		
Habitat for Wetland-Associated Birds		<b>X</b>	No permanent inundation occurs.		
General Fish Habitat		<b>X</b>	Wetland is not associated with a fish bearing water.		
Native Plant Richness		<b>X</b>	Wetland has two Cowardin classes. However, non-native invasive vegetation is also co-dominant ( <i>Phalaris arundinacea</i> , <i>Rubus armeniacus</i> ).		
Educational or Scientific Value		<b>X</b>	There is no nearby parking & the site has no documented scientific or educational use.		
Uniqueness and Heritage		<b>X</b>	No documented protected species or habitat; not determined significant by local jurisdiction.		

# Wetland Functions & Values Form

Wetland I.D. 25F Project: ELST South Sammamish Segment B Assessed by: Erik Christensen  
 Cowardin Class: PFO Ecology Category: IV Local Rating: IV Wetland size: 0.06 acre Date: 11/08/07 (rev: 9/27/13)

Function/Value	Occurrence		Rationale	Principal Function(s)	Comments
	Y	N			
Flood Flow Alteration	<b>X</b>		Wetland has dense woody vegetation and is associated with a water course. Function limited by wetland size.		Rating=Low Qualifiers: (5, 6)
Sediment Removal	<b>X</b>		Occasional ponding occurs in wetland.		Rating=Low Qualifiers: (1, 3, 5)
Nutrient & Toxicant Removal	<b>X</b>		Occasional ponding occurs in wetland.		Rating=Low Qualifiers: (1, 4, 6)
Erosion Control & Shoreline Stabilization	<b>X</b>		The wetland is PFO with a water course adjacent to it. Limited association with stream.		Rating=Low Qualifiers: (1, 2, 3)
Production of Organic Matter and its Export	<b>X</b>		Wetland is dominated by deciduous trees and shrubs. Export of nutrients occurs from stream running adjacent to the wetland. Function is limited by wetland size.		Rating=Low Qualifiers: (2, 3, 5, 6)
General Habitat Suitability	<b>X</b>		Diversity of plant species is moderate. Wetland has PFO Cowardin class and is connected to a stream. However, wetland is surrounded by residential development and is small.		Rating=Low Qualifiers: (3, 4, 5)
Habitat for Aquatic Invertebrates		<b>X</b>	No seasonal or permanent ponding in wetland.		
Habitat for Amphibians		<b>X</b>	No seasonal or permanent ponding in wetland.		
Habitat for Wetland-Associated Mammals		<b>X</b>	Permanent ponding does not occur in wetland.		
Habitat for Wetland-Associated Birds		<b>X</b>	No open water component present.		
General Fish Habitat	<b>X</b>		Wetland has a PFO Cowardin class that offer shade, cover, and detrital matter for the stream. Limited association with stream.		Rating=Low Qualifiers: (1, 4)
Native Plant Richness	<b>X</b>		Wetland has one Cowardin class. Non-native invasive vegetation is co-dominant ( <i>Phalaris arundinacea</i> ).		
Educational or Scientific Value	<b>X</b>		There is no nearby parking & the site has no documented scientific or educational use.		
Uniqueness and Heritage	<b>X</b>		No documented protected species or habitat; not determined significant by local jurisdiction.		

# Wetland Functions & Values Form

Wetland I.D. 26A Project: ELST South Sammamish Segment B Assessed by: Erik Christensen  
 Cowardin Class: PFO/PSS/PEM Ecology Category: III Local Rating: III Wetland size: 0.91 acre Date: 11/09/07 (rev: 9/27/13)

Function/Value	Occurrence		Rationale	Principal Function(s)	Comments
	Y	N			
Flood Flow Alteration	<b>X</b>		Wetland has dense woody vegetation and is associated with a water course.		Rating=Low Qualifiers: (5, 6)
Sediment Removal	<b>X</b>		Seasonal ponding occurs in portion of the wetland.		Rating=Low Qualifiers: (1, 3, 5)
Nutrient & Toxicant Removal	<b>X</b>		Seasonal ponding occurs in portion of the wetland.		Rating=Low Qualifiers: (1, 2, 4)
Erosion Control & Shoreline Stabilization	<b>X</b>		The wetland is associated with Zaccuse Creek and has woody vegetation. Limited association with stream.		Rating=Low Qualifiers: (1, 2, 3)
Production of Organic Matter and its Export	<b>X</b>		Wetland is dominated by deciduous shrubs. Stream running through wetland provides export of nutrients. Limited association with stream.		Rating=Low Qualifiers: (1, 2, 3, 5, 6)
General Habitat Suitability	<b>X</b>		Diversity of plant species is moderate. Wetland has three Cowardin classes and is connected to a stream. However, wetland is surrounded by residential development and roads.		Rating=Moderate Qualifiers: (3, 4, 5)
Habitat for Aquatic Invertebrates	<b>X</b>		Seasonal inundation occurs. Wetland has three Cowardin classes which produce leaf litter and is connected to a stream.		Rating=Low Qualifiers: (1, 5, 6)
Habitat for Amphibians	<b>X</b>		Seasonal inundation occurs. The wetland is connected to a stream.		Rating=Low Qualifiers: (1, 6)
Habitat for Wetland-Associated Mammals		<b>X</b>	Permanent ponding does not occur in wetland.		
Habitat for Wetland-Associated Birds		<b>X</b>	No open water occurs in the wetland.		
General Fish Habitat	<b>X</b>		Wetland has a PSS Cowardin class that offers shade, cover, and detrital matter for the stream. Limited association with stream.		Rating=Low Qualifiers: (1, 4)
Native Plant Richness		<b>X</b>	Wetland has three Cowardin classes. However, non-native invasive vegetation is co-dominant ( <i>Phalaris arundinacea</i> ).		
Educational or Scientific Value		<b>X</b>	There is no nearby parking & the site has no documented scientific or educational use.		
Uniqueness and Heritage		<b>X</b>	No documented protected species or habitat; not determined significant by local jurisdiction.		

# Wetland Functions & Values Form

Wetland I.D. 26B Project: ELST South Sammamish Segment B Assessed by: M. Maynard  
 Cowardin Class: PEM Ecology Category: IV Local Rating: IV Wetland size: 0.02 acre Date: 11/02/07 (rev: 3/20/14)

Function/Value	Occurrence		Rationale	Principal Function(s)	Comments
	Y	N			
Flood Flow Alteration		<input checked="" type="checkbox"/>	Wetland likely does not provide this function since it is a slope HGM class.		
Sediment Removal		<input checked="" type="checkbox"/>	Wetland likely does not provide this function since it is a slope HGM class and is maintained lawn/yard.		
Nutrient & Toxicant Removal		<input checked="" type="checkbox"/>	Wetland likely does not provide this function since it is a slope HGM class and is maintained lawn/yard.		
Erosion Control & Shoreline Stabilization		<input checked="" type="checkbox"/>	Wetland is not associated with a water course.		
Production of Organic Matter and its Export		<input checked="" type="checkbox"/>	The wetland has at least 30% cover of herbaceous vegetation, but no inundation and no outlet for export.		
General Habitat Suitability		<input checked="" type="checkbox"/>	This is a small wetland on maintained lawn/yard, near other wetlands, but connectivity is fragmented by driveways.		
Habitat for Aquatic Invertebrates		<input checked="" type="checkbox"/>	Wetland is sloped and no inundation occurs.		
Habitat for Amphibians		<input checked="" type="checkbox"/>	Wetland is sloped and no inundation occurs.		
Habitat for Wetland-Associated Mammals		<input checked="" type="checkbox"/>	Wetland is sloped and no inundation occurs.		
Habitat for Wetland-Associated Birds		<input checked="" type="checkbox"/>	Wetland is sloped and no inundation occurs.		
General Fish Habitat		<input checked="" type="checkbox"/>	Wetland is not associated with a fish-bearing water.		
Native Plant Richness		<input checked="" type="checkbox"/>	Wetland is dominated by lawn.		
Educational or Scientific Value		<input checked="" type="checkbox"/>	There is no nearby parking & the site has no documented scientific or educational use.		
Uniqueness and Heritage		<input checked="" type="checkbox"/>	No documented protected species or habitat; not determined significant by local jurisdiction.		

# Wetland Functions & Values Form

Wetland I.D. 26C Project: ELST South Sammamish Segment B Assessed by: M. Maynard  
 Cowardin Class: PEM Ecology Category: IV Local Rating: IV Wetland size: 0.03 acre Date: 11/2/07 (rev: 3/20/14)

Function/Value	Occurrence		Rationale	Principal Function(s)	Comments
	Y	N			
Flood Flow Alteration	<b>X</b>		Wetland provides minimal support based on size, its flat shape, and is mostly maintained lawn/yard.		Rating: Low
Sediment Removal	<b>X</b>		Wetland provides minimal support based on size, its flat shape, and is mostly maintained lawn/yard.		Rating: Low
Nutrient & Toxicant Removal	<b>X</b>		Wetland provides minimal support based on size, its flat shape, and is mostly maintained lawn/yard.		Rating: Low
Erosion Control & Shoreline Stabilization		<b>X</b>	Wetland is not associated with a water course.		
Production of Organic Matter and its Export		<b>X</b>	The wetland has at least 30% cover of herbaceous vegetation, but is mostly maintained lawn, lacks inundation, and lacks connection to downgradient aquatic areas for export.		
General Habitat Suitability	<b>X</b>		Majority of wetland is maintained lawn. The wetland is near other wetlands, but connectivity is fragmented by driveways.		Rating: Low
Habitat for Aquatic Invertebrates		<b>X</b>	No inundation occurs.		
Habitat for Amphibians		<b>X</b>	No inundation occurs.		
Habitat for Wetland-Associated Mammals		<b>X</b>	No inundation occurs.		
Habitat for Wetland-Associated Birds		<b>X</b>	No inundation occurs.		
General Fish Habitat		<b>X</b>	Wetland is not associated with a fish-bearing water.		
Native Plant Richness		<b>X</b>	Wetland is mostly lawn, with some native species in the shrub community.		
Educational or Scientific Value		<b>X</b>	There is no nearby parking & the site has no documented scientific or educational use.		
Uniqueness and Heritage		<b>X</b>	No documented protected species or habitat; not determined significant by local jurisdiction.		

# Wetland Functions & Values Form

Wetland I.D. 26D Project: ELST South Sammamish Segment B Assessed by: Colin Worsley

Cowardin Class: PSS/PEM Ecology Category: III Local Rating: III Wetland size: ~0.13 acre Date: 03/19/14

Function/Value	Occurrence		Rationale	Principal Function(s)	Comments
	Y	N			
Flood Flow Alteration	<b>X</b>		Wetland likely provides minimal support for this function since it has lake-fringe and riverine HGM classes with no constricted outlet.		Rating=Low Qualifiers: (6)
Sediment Removal	<b>X</b>		Wetland likely provides minimal support for this function.		Rating=Low Qualifiers: (1)
Nutrient & Toxicant Removal	<b>X</b>		Wetland likely provides minimal support for this function.		Rating=Low Qualifiers: (1, 5)
Erosion Control & Shoreline Stabilization	<b>X</b>		Wetland is associated with one unnamed stream (#9) and the shoreline of Lake Sammamish. However, vegetation composition and condition limits this function.		Rating=Low
Production of Organic Matter and its Export	<b>X</b>		The wetland has deciduous shrub and herbaceous vegetation. Some organic matter may be exported via the associated unnamed stream (#9) and the shoreline of Lake Sammamish.		Rating=Low Qualifiers: (1, 2, 6)
General Habitat Suitability	<b>X</b>		PSS and PEM Cowardin classes are present. Wetland is surrounded by residential development.		Rating=Low Qualifiers: (3, 5)
Habitat for Aquatic Invertebrates	<b>X</b>		Wetland is lake-fringe and has a perennial stream flowing through it.		Rating=Low Qualifiers: (6)
Habitat for Amphibians	<b>X</b>		Wetland has lake-fringe HGM class and a perennial stream flowing through it.		Rating=Low Qualifiers: (6)
Habitat for Wetland-Associated Mammals	<b>X</b>		Wetland has lake-fringe HGM class and a perennial stream flowing through it.		Rating=Low
Habitat for Wetland-Associated Birds	<b>X</b>		Wetland has lake-fringe HGM class (Lake Sammamish).		Rating=Low
General Fish Habitat	<b>X</b>		Wetland has lake-fringe HGM class and a perennial stream flowing through it.		Rating=Low
Native Plant Richness	<b>X</b>		Wetland has two Cowardin classes and has been planted as part of a restoration project.		Rating=Low
Educational or Scientific Value		<b>X</b>	There is no nearby parking & the site has no documented scientific or educational use.		
Uniqueness and Heritage		<b>X</b>	No documented protected species or habitat; not determined significant by local jurisdiction.		

Exhibit 16

SSDP2016-00415  
001314

# Wetland Functions & Values Form

Wetland I.D. 28A Project: ELST South Sammamish Segment B Assessed by: Erik Christensen

Cowardin Class: PFO Ecology Category: IV Local Rating: IV Wetland size: 0.09 acre Date: 11/13/07 (rev: 09/27/13)

Function/Value	Occurrence		Rationale	Principal Function(s)	Comments
	Y	N			
Flood Flow Alteration	<b>X</b>		Wetland has dense woody vegetation and is associated with a water course. However, dense wood vegetation is not located in the water course.		Rating=Low Qualifiers: (5, 6)
Sediment Removal	<b>X</b>		Permanent ponding occurs in the ditched portion of the wetland at the toe of slope.		Rating=Low Qualifiers: (1, 3, 5)
Nutrient & Toxicant Removal	<b>X</b>		Permanent ponding occurs in the ditched portion of the wetland at the toe of slope.		Rating=Low Qualifiers: (1, 2)
Erosion Control & Shoreline Stabilization	<b>X</b>		The wetland has a Cowardin class of PFO with a water course flowing through it.		Rating=Moderate Qualifiers: (1, 2, 3)
Production of Organic Matter and its Export	<b>X</b>		Wetland is dominated by deciduous trees and shrubs. Export of nutrients occurs from stream running through the wetland		Rating=Moderate Qualifiers: (2, 6)
General Habitat Suitability	<b>X</b>		Wetland is associated with a stream. However, wetland is surrounded by residential development and roads.		Rating=Low Qualifiers: (3)
Habitat for Aquatic Invertebrates	<b>X</b>		Permanent inundation occurs in the ditch. The wetland has deciduous plants which produces leaf litter and is associated with a stream.		Rating=Moderate Qualifiers: (1, 5, 6)
Habitat for Amphibians	<b>X</b>		Permanent inundation and emergent vegetation occurs in the ditch. The wetland is associated with a stream. However, there is development surrounding the wetland.		Rating=Low Qualifiers: (1, 4, 6)
Habitat for Wetland-Associated Mammals		<b>X</b>	Permanent ponding is insufficient for wetland-associated mammals.		
Habitat for Wetland-Associated Birds		<b>X</b>	No open water occurs in the wetland		
General Fish Habitat	<b>X</b>		Wetland has a PFO Cowardin class that offers shade, cover, and detrital matter for associated stream, which is potentially fish-bearing.		Rating=Low Qualifiers: (4)
Native Plant Richness		<b>X</b>	Non-native invasive vegetation is codominant ( <i>Phalaris arundinacea</i> , <i>Rubus armeniacus</i> ).		
Educational or Scientific Value		<b>X</b>	There is no nearby parking & the site has no documented scientific or educational use.		
Uniqueness and Heritage		<b>X</b>	No documented protected species or habitat; not determined significant by local jurisdiction.		



# Wetland Functions & Values Form

Wetland I.D. 28B Project: ELST South Sammamish Segment B Assessed by: Erik Christensen

Cowardin Class: PSS Ecology Category: IV Local Rating: IV Wetland size: 0.02 acre Date: 11/09/07 (rev: 09/27/13)

Function/Value	Occurrence		Rationale	Principal Function(s)	Comments
	Y	N			
Flood Flow Alteration		<input checked="" type="checkbox"/>	Wetland likely does not provide this function since wetland is sloped and no qualifiers are present.		
Sediment Removal		<input checked="" type="checkbox"/>	Wetland likely does not provide this function since wetland is sloped and no qualifiers are present.		
Nutrient & Toxicant Removal		<input checked="" type="checkbox"/>	Wetland is sloped. No qualifiers are present.		
Erosion Control & Shoreline Stabilization		<input checked="" type="checkbox"/>			
Production of Organic Matter and its Export	<input checked="" type="checkbox"/>		Wetland is dominated by deciduous shrubs. Export of nutrients occurs to ditch below the wetland.		Rating=Low Qualifiers: (2, 6)
General Habitat Suitability		<input checked="" type="checkbox"/>	Wetland is surrounded by residential development and roads.		
Habitat for Aquatic Invertebrates		<input checked="" type="checkbox"/>	Wetland likely does not provide this function since it occasionally inundated.		
Habitat for Amphibians		<input checked="" type="checkbox"/>	Wetland likely does not provide this function since it occasionally inundated.		
Habitat for Wetland-Associated Mammals		<input checked="" type="checkbox"/>	Permanent ponding does not occur in wetland.		
Habitat for Wetland-Associated Birds		<input checked="" type="checkbox"/>	No open water occurs in the wetland.		
General Fish Habitat		<input checked="" type="checkbox"/>	Wetland is not associated with a fish bearing water.		
Native Plant Richness		<input checked="" type="checkbox"/>	Non-native invasive vegetation is codominant ( <i>Rubus armeniacus/Phalaris arundinacea</i> ).		
Educational or Scientific Value		<input checked="" type="checkbox"/>	There is no nearby parking & the site has no documented scientific or educational use.		
Uniqueness and Heritage		<input checked="" type="checkbox"/>	No documented protected species or habitat; not determined significant by local jurisdiction.		

# Wetland Functions & Values Form

Wetland I.D. 28C Project: ELST South Sammamish Segment B Assessed by: Matt Maynard

Cowardin Class: PSS/PEM Ecology Category: IV Local Rating: IV Wetland size: 0.02 acre Date: 11/13/07 (rev: 09/27/13)

Function/Value	Occurrence		Rationale	Principal Function(s)	Comments
	Y	N			
Flood Flow Alteration	<b>X</b>		Wetland likely provides some support for this function since it is a small depressional wetland. The wetland is dominated by herbaceous vegetation.		Rating=Low Qualifiers: (2)
Sediment Removal	<b>X</b>		A vegetated ditch with slow moving, seasonal water is located in the wetland.		Rating=Low Qualifiers: (1, 2, 3)
Nutrient & Toxicant Removal	<b>X</b>		A vegetated ditch with seasonal inundation is located in the wetland. Wetland receives runoff from the trail and a slope to the east.		Rating=Low Qualifiers: (1, 2, 4)
Erosion Control & Shoreline Stabilization		<b>X</b>	Wetland is not associated with a shoreline.		
Production of Organic Matter and its Export	<b>X</b>		The wetland has at least 30% cover of herbaceous vegetation and has outlets for exporting organic matter.		Rating=Low Qualifiers: (1, 6)
General Habitat Suitability	<b>X</b>		The wetland is fragmented by East Lake Sammamish Parkway, residential development, and the trail. Limited connectivity to upland slope.		Rating=Low Qualifiers: (1, 3)
Habitat for Aquatic Invertebrates	<b>X</b>		Seasonal inundation and emergent vegetation occur in the ditch.		Rating=Low Qualifiers: (1, 4, 6)
Habitat for Amphibians	<b>X</b>		Seasonal inundation and emergent vegetation occur in the ditch.		Rating=Low Qualifiers: (1, 2, 6)
Habitat for Wetland-Associated Mammals		<b>X</b>	Permanent inundation does not occur.		
Habitat for Wetland-Associated Birds		<b>X</b>	Permanent inundation and open water do not occur.		
General Fish Habitat		<b>X</b>	Wetland is not associated with a fish bearing water.		
Native Plant Richness		<b>X</b>	Codominant vegetation is non-native (unknown ornamental).		
Educational or Scientific Value		<b>X</b>	There is no nearby parking & the site has no documented scientific or educational use.		
Uniqueness and Heritage		<b>X</b>	No documented protected species or habitat; not determined significant by local jurisdiction.		

# Wetland Functions & Values Form

Wetland I.D. 28D Project: ELST South Sammamish Segment B Assessed by: Erik Christensen

Cowardin Class: PEM Ecology Category: IV Local Rating: IV Wetland size: <0.01 acre Date: 11/13/07 (rev: 09/27/13)

Function/Value	Occurrence		Rationale	Principal Function(s)	Comments
	Y	N			
Flood Flow Alteration		<input checked="" type="checkbox"/>	Wetland is a ditch. No qualifiers are present		
Sediment Removal		<input checked="" type="checkbox"/>	Wetland is a ditch. No qualifiers are present		
Nutrient & Toxicant Removal		<input checked="" type="checkbox"/>	Wetland is a ditch. No qualifiers are present		
Erosion Control & Shoreline Stabilization	<input checked="" type="checkbox"/>		The wetland is has a Cowardin class of PEM with an occasionally flowing water course through it.		Rating=Moderate Qualifiers: (1, 2)
Production of Organic Matter and its Export	<input checked="" type="checkbox"/>		Wetland is dominated by deciduous shrubs. Export of nutrients occurs from stream running through the wetland		Rating=Moderate Qualifiers: (2, 6)
General Habitat Suitability		<input checked="" type="checkbox"/>	Wetland is a ditch and is surrounded by residential development and roads.		
Habitat for Aquatic Invertebrates		<input checked="" type="checkbox"/>	Wetland is a ditch with occasional inundation.		
Habitat for Amphibians		<input checked="" type="checkbox"/>	Wetland is a ditch with occasional inundation.		
Habitat for Wetland-Associated Mammals		<input checked="" type="checkbox"/>	Permanent ponding suitable for mammals does not occur in wetland.		
Habitat for Wetland-Associated Birds		<input checked="" type="checkbox"/>	No open water occurs in the wetland		
General Fish Habitat		<input checked="" type="checkbox"/>	Wetland is not associated with a fish bearing water.		
Native Plant Richness		<input checked="" type="checkbox"/>	Non-native invasive vegetation is codominate ( <i>Rubus armeniacus</i> ).		
Educational or Scientific Value		<input checked="" type="checkbox"/>	There is no nearby parking & the site has no documented scientific or educational use.		
Uniqueness and Heritage		<input checked="" type="checkbox"/>	No documented protected species or habitat; not determined significant by local jurisdiction.		

# Wetland Functions & Values Form

Wetland I.D. 28E Project: ELST South Sammamish Segment B Assessed by: Matt Maynard/Colin Worsley

Cowardin Class: PEM Ecology Category: IV Local Rating: IV Wetland size: 0.02 acre Date: 11/01/13

Function/Value	Occurrence		Rationale	Principal Function(s)	Comments
	Y	N			
Flood Flow Alteration	<b>X</b>		Wetland is a small, closed depressional system with surface water limited to ditch, has capacity for very minimal water detention.		Rating=Low Qualifiers: (3)
Sediment Removal	<b>X</b>		Wetland may receive some sediment from trail. Surface water limited to ditch.		Rating=Low Qualifiers: (1, 3)
Nutrient & Toxicant Removal	<b>X</b>		May receive nutrients/ toxicants from adjacent roadways and residences. The wetland is a closed depressional system. Surface water limited to ditch.		Rating=Low Qualifiers: (1, 4)
Erosion Control & Shoreline Stabilization		<b>X</b>	Wetland is not associated with a water course or shoreline.		
Production of Organic Matter and its Export		<b>X</b>	Dense vegetation is present in wetland, but the wetland is a closed depressional system with no outlet.		
General Habitat Suitability		<b>X</b>	Wetland is a small depression adjacent to trail and residences with one Cowardin class (PEM).		
Habitat for Aquatic Invertebrates		<b>X</b>	Surface water limited to ditch.		
Habitat for Amphibians		<b>X</b>	Surface water limited to ditch.		
Habitat for Wetland-Associated Mammals		<b>X</b>	Insufficient ponding for wetland-associated mammals.		
Habitat for Wetland-Associated Birds		<b>X</b>	No open water component in the wetland.		
General Fish Habitat		<b>X</b>	Wetland is not associated with a fish bearing water.		
Native Plant Richness		<b>X</b>	Wetland has one Cowardin class and vegetation is dominated by invasive species.		
Educational or Scientific Value		<b>X</b>	There is no nearby parking & the site has no documented scientific or educational use.		
Uniqueness and Heritage		<b>X</b>	No documented protected species or habitat; not determined significant by local jurisdiction.		

# Wetland Functions & Values Form

Wetland I.D. 29B Project: ELST South Sammamish Segment B Assessed by: M. Maynard

Cowardin Class: PEM Ecology Category: IV Local Rating: IV Wetland size: 0.03 acre Date: 11/08/07 (rev: 09/27/13)

Function/Value	Occurrence		Rationale	Principal Function(s)	Comments
	Y	N			
Flood Flow Alteration		<input checked="" type="checkbox"/>	Wetland likely does not provide this function since it is a slope HGM class and is maintained lawn/yard.		
Sediment Removal		<input checked="" type="checkbox"/>	Wetland likely does not provide this function since it is a slope HGM class and is maintained lawn/yard.		
Nutrient & Toxicant Removal		<input checked="" type="checkbox"/>	Wetland likely does not provide this function since it is a slope HGM class.		
Erosion Control & Shoreline Stabilization		<input checked="" type="checkbox"/>	Wetland likely does not provide this function since it is a slope HGM class and is not associated with a water course.		
Production of Organic Matter and its Export		<input checked="" type="checkbox"/>	Wetland is densely vegetated with herbaceous vegetation. However, inundation does not occur and organic material export is minimal.		
General Habitat Suitability		<input checked="" type="checkbox"/>	Wetland is a maintained yard and connectivity is fragmented by residential development.		
Habitat for Aquatic Invertebrates		<input checked="" type="checkbox"/>	Wetland has a slope HGM class and is saturated only. Inundation does not occur.		
Habitat for Amphibians		<input checked="" type="checkbox"/>	Wetland has a slope HGM class and is saturated only. Inundation does not occur.		
Habitat for Wetland-Associated Mammals		<input checked="" type="checkbox"/>	Wetland has a slope HGM class and is saturated only. Inundation does not occur.		
Habitat for Wetland-Associated Birds		<input checked="" type="checkbox"/>	Wetland has a slope HGM class and is saturated only. Inundation does not occur.		
General Fish Habitat		<input checked="" type="checkbox"/>	Wetland is not associated with a fish-bearing water.		
Native Plant Richness		<input checked="" type="checkbox"/>	The wetland is a maintained lawn dominated by mowed grass.		
Educational or Scientific Value		<input checked="" type="checkbox"/>	There is no nearby parking & the site has no documented scientific or educational use.		
Uniqueness and Heritage		<input checked="" type="checkbox"/>	No documented protected species or habitat; not determined significant by local jurisdiction.		

# Wetland Functions & Values Form

Wetland I.D. 29C Project: ELST South Sammamish Segment B Assessed by: M. Maynard

Cowardin Class: PFO Ecology Category: IV Local Rating: IV Wetland size: 0.06 acre Date: 11/08/07 (rev: 03/20/14)

Function/Value	Occurrence		Rationale	Principal Function(s)	Comments
	Y	N			
Flood Flow Alteration		<input checked="" type="checkbox"/>	Wetland likely does not provide this function.		
Sediment Removal	<input checked="" type="checkbox"/>		Wetland likely provides minimal support for this function.		Rating=Low
Nutrient & Toxicant Removal	<input checked="" type="checkbox"/>		Wetland likely provides minimal support for this function.		Rating=Low
Erosion Control & Shoreline Stabilization	<input checked="" type="checkbox"/>		Wetland likely provides minimal support for this function. Associated with Lake Sammamish.		Rating=Low
Production of Organic Matter and its Export	<input checked="" type="checkbox"/>		Wetland is densely covered with herbaceous vegetation and drains into a stream to the south of the wetland and Lake Sammamish.		Rating=Moderate Qualifiers: (1, 5, 6)
General Habitat Suitability	<input checked="" type="checkbox"/>		Wetland is small and connectivity is fragmented.		Rating=Low
Habitat for Aquatic Invertebrates	<input checked="" type="checkbox"/>		Ditch is vegetated with emergent vegetation and is seasonally inundated. A stream is located south of the wetland and Lake Sammamish to the west.		Rating=Low Qualifiers: (1, 4, 6)
Habitat for Amphibians	<input checked="" type="checkbox"/>		Ditch is vegetated with emergent vegetation and is seasonally inundated. A stream is located south of the wetland and Lake Sammamish to the west.		Rating=Low Qualifiers: (1, 2, 6)
Habitat for Wetland-Associated Mammals	<input checked="" type="checkbox"/>		No permanent inundation occurs in the wetland. Connected to Lake Sammamish.		Rating=Low
Habitat for Wetland-Associated Birds	<input checked="" type="checkbox"/>		No open water occurs in the wetland. Connected to Lake Sammamish.		Rating=Low
General Fish Habitat	<input checked="" type="checkbox"/>		Connected to Lake Sammamish.		Rating=Low
Native Plant Richness	<input checked="" type="checkbox"/>		Dominated vegetation in wetland is native.		Rating=Low Qualifiers: (1)
Educational or Scientific Value		<input checked="" type="checkbox"/>	There is no nearby parking & the site has no documented scientific or educational use.		
Uniqueness and Heritage		<input checked="" type="checkbox"/>	No documented protected species or habitat; not determined significant by local jurisdiction.		

# Wetland Functions & Values Form

Wetland I.D. 29D Project: ELST South Sammamish Segment B Assessed by: M. Maynard  
 Cowardin Class: PEM/PSS Ecology Category: IV Local Rating: IV Wetland size: 0.08 acre Date: 11/13/07 (rev: 09/27/13)

Function/Value	Occurrence		Rationale	Principal Function(s)	Comments
	Y	N			
Flood Flow Alteration	<b>X</b>		Wetland likely provides this function, although in a limited capacity due to the depressional portion being ditched.		Rating=Low Qualifiers: (2)
Sediment Removal	<b>X</b>		Wetland is densely vegetated, but sediment sources are limited.		Rating=Low Qualifiers: (3, 5)
Nutrient & Toxicant Removal	<b>X</b>		Wetland is densely vegetated and some toxicants may be provided by road or trail.		Rating=Low Qualifiers: (1, 2, 4)
Erosion Control & Shoreline Stabilization	<b>X</b>		Wetland is densely vegetated, but water flow is limited through Wetland 29D.		Rating=Low Qualifiers: (1, 2, 3)
Production of Organic Matter and its Export	<b>X</b>		Wetland is densely covered with herbaceous vegetation and drains into a stream to the north of the wetland.		Rating=Moderate Qualifiers: (1, 2, 5, 6)
General Habitat Suitability	<b>X</b>		Wetland is connectivity is fragmented, but wetland has multiple Cowardin classes.		Rating=Low Qualifiers: (5)
Habitat for Aquatic Invertebrates		<b>X</b>	Wetland likely does not provide this function, since wetland does not appear to be seasonally inundated and when ponding occurs, is shallow.		
Habitat for Amphibians		<b>X</b>	Wetland likely does not provide this function, since wetland does not appear to be seasonally inundated and when ponding occurs, is shallow.		
Habitat for Wetland-Associated Mammals		<b>X</b>	No permanent inundation occurs in the wetland.		
Habitat for Wetland-Associated Birds		<b>X</b>	No open water occurs in the wetland.		
General Fish Habitat		<b>X</b>	Wetland likely does not provide this function since it is not associated with a stream.		
Native Plant Richness	<b>X</b>		Dominate vegetation in wetland is not native, but wetland has multiple Cowardin classes with three strata.		Rating=Low Qualifiers: (2, 3)
Educational or Scientific Value		<b>X</b>	There is no nearby parking & the site has no documented scientific or educational use.		
Uniqueness and Heritage		<b>X</b>	No documented protected species or habitat; not determined significant by local jurisdiction.		

# Wetland Functions & Values Form

Wetland I.D. 30B Project: ELST South Sammamish Segment B Assessed by: Erik Christensen  
 Cowardin Class: PFO Ecology Category: III Local Rating: III Wetland size: 0.20 acre Date: 01/11/08 (rev: 09/27/13)

Function/Value	Occurrence		Rationale	Principal Function(s)	Comments
	Y	N			
Flood Flow Alteration	<b>X</b>		Wetland contains a vegetated ditch that is permanently ponded.		Rating=Low Qualifiers: (4, 5)
Sediment Removal	<b>X</b>		Wetland contains a vegetated ditch that is permanently ponded.		Rating=Low Qualifiers: (1, 3, 5)
Nutrient & Toxicant Removal	<b>X</b>		Wetland receives runoff from upslope towards East Lake Sammamish Parkway and is densely vegetated.		Rating=Moderate Qualifiers: (1, 4)
Erosion Control & Shoreline Stabilization	<b>X</b>		Wetland is associated with Tributary 0143L with vegetation growing in channel.		Rating=Low
Production of Organic Matter and its Export	<b>X</b>		Wetland is densely vegetated with herbaceous and deciduous woody vegetation. Export occurs through Tributary 0143L.		Rating= Moderate Qualifiers: (1, 2, 3, 6)
General Habitat Suitability	<b>X</b>		Wetland is a mitigation site and has been enhanced with vegetation and habitat structures.		Rating= Moderate Qualifiers: (3, 5)
Habitat for Aquatic Invertebrates	<b>X</b>		Wetland is associated with Tributary 0143L and also contains a vegetated ditch that is seasonally ponded.		Rating=Moderate Qualifiers: (4, 5, 6)
Habitat for Amphibians	<b>X</b>		Wetland is associated with Tributary 0143L and also contains a vegetated ditch that is seasonally ponded.		Rating=Moderate Qualifiers: (1, 2)
Habitat for Wetland-Associated Mammals		<b>X</b>	No permanent inundation occurs in the wetland.		
Habitat for Wetland-Associated Birds		<b>X</b>	No open water occurs in the wetland.		
General Fish Habitat	<b>X</b>		Wetland is associated with Tributary 0143L.		Rating=Moderate Qualifiers: (1, 4)
Native Plant Richness	<b>X</b>		Wetland contains mature trees, and is dominated by native vegetation with some invasive species.		Rating=Moderate Qualifiers: (1, 2, 3, 4)
Educational or Scientific Value		<b>X</b>	There is no nearby parking & the site has no documented scientific or educational use.		
Uniqueness and Heritage		<b>X</b>	No documented protected species or habitat; not determined significant by local jurisdiction		



# APPENDIX D

## Critical Area Impact Figures

FILE: BL1521075P19T09F-01 LAYOUT: F1 PATH: U:\FSO\Projects\Clients\1521-KingCo\564-1521-075-ELST\995secs\CADD\Phase 19\Task 09\SEC B PLOTTED BY: purcabut DATE: Friday, July 07, 2017 12:27:02 PM

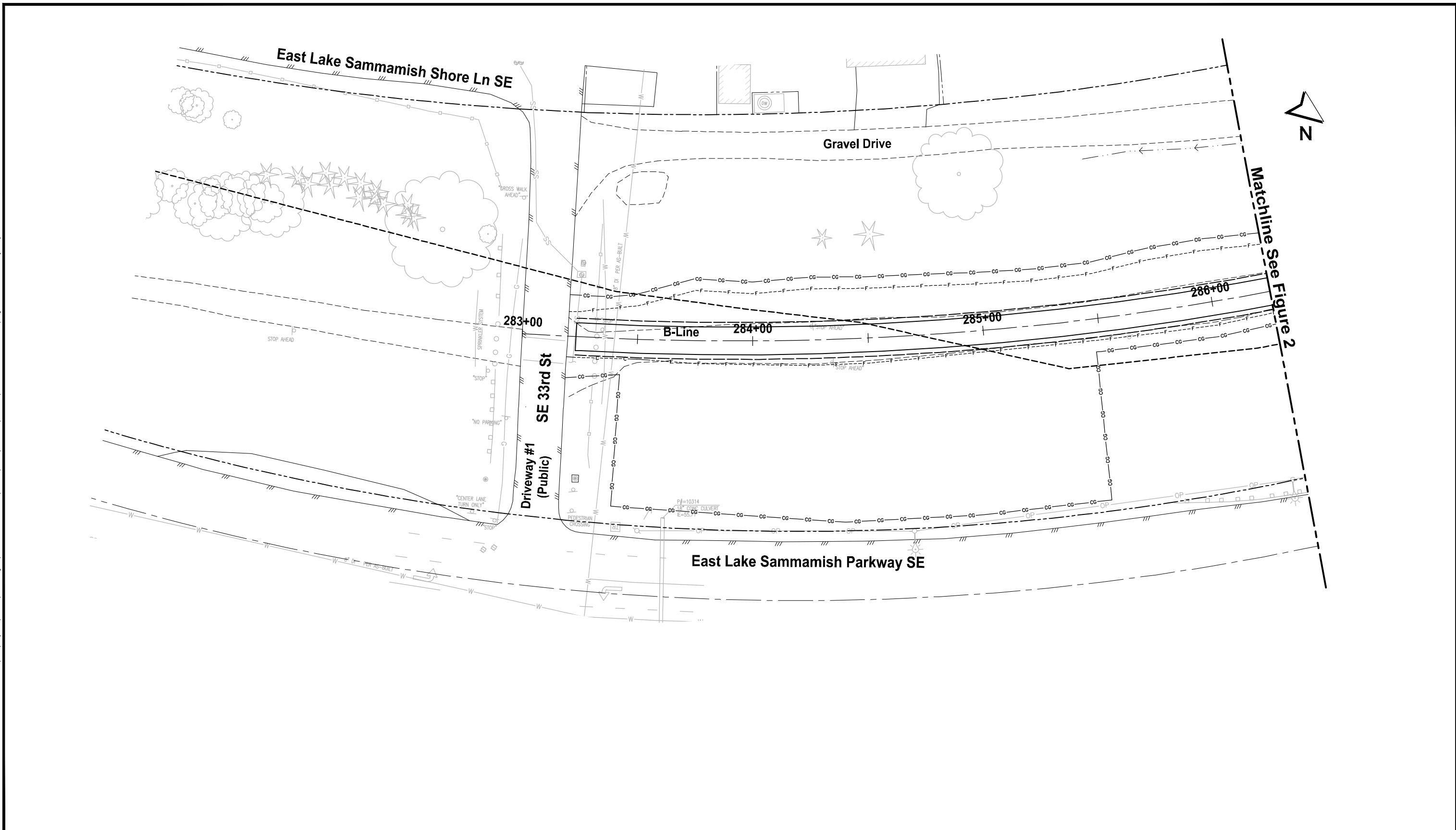

Parametrix DATE: July 7, 2017 FILE: BL1521075P19T09F-01



**Legend:**

- |                   |                   |               |                           |                        |                             |                    |                                |
|-------------------|-------------------|---------------|---------------------------|------------------------|-----------------------------|--------------------|--------------------------------|
| 10C-SP2           | Data Plot         | ---           | 50-Foot Shoreline Setback | [Cross-hatch]          | Perm. Wetland Impact        | [Circular pattern] | Perm. Stream Buffer Impact     |
| Wetland Boundary  | Wetland Boundary  | ---           | 200-Foot Shoreline Zone   | [Diagonal cross-hatch] | Temp. Wetland Impact        | [Circular pattern] | Temp. Stream Buffer Impact     |
| Wetland Buffer    | Wetland Buffer    | ---           | Right of Way              | [Horizontal lines]     | Perm. Wetland Buffer Impact | [Diagonal lines]   | Temp. Shoreline Setback Impact |
| Stream Buffer     | Stream Buffer     | [Thick solid] | Retaining Walls           | [Vertical lines]       | Temp. Wetland Buffer Impact | [Diagonal lines]   | Perm. Shoreline Setback Impact |
| Stream OHWM       | Stream OHWM       | [Dashed]      | Fill Limit                | [Dotted]               | ---                         | [Diagonal lines]   | Temp. Stream Impact            |
| Stream Centerline | Stream Centerline | [Dashed]      | Cut Limit                 | [Dotted]               | ---                         | [Diagonal lines]   |                                |
| Ditch             | Ditch             | [Dashed]      | Clearing/Grubbing Limit   | CG CG                  |                             |                    |                                |
| Lake OHWM         | Lake OHWM         | [Dashed]      |                           |                        |                             |                    |                                |

**Figure 1**  
**Critical Area Impacts**  
 East Lake Sammamish Trail  
 South Sammamish Segment B

Exhibit 16  
 SSDP-2016-00413  
 09/13/25

FILE: BL1521075P19T09F-01 LAYOUT: F2 PATH: U:\PSO\Projects\Clients\1521-KingCo\_564-1521-075-ELST\99Sves\CADD\Phase 19\Task 09\SEC B PLOTTED BY: purgabot DATE: Friday, July 07, 2017 12:27:18 PM

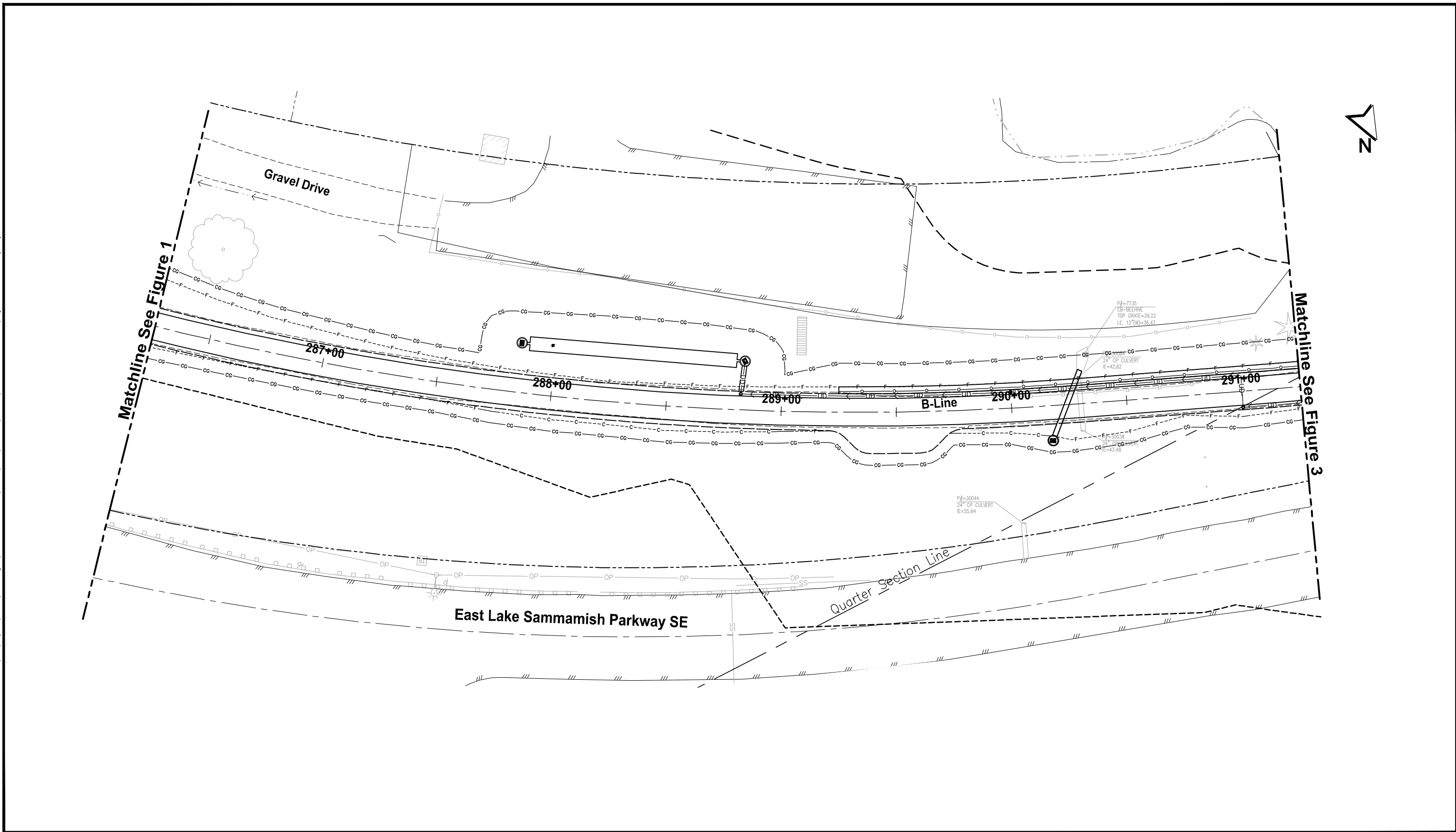

Matchline See Figure 1

Matchline See Figure 3

**Legend:**

- |         |                   |       |                           |                        |                             |                         |                                |
|---------|-------------------|-------|---------------------------|------------------------|-----------------------------|-------------------------|--------------------------------|
| 10C-SP2 | Data Plot         | ----- | 50-Foot Shoreline Setback | [Cross-hatch pattern]  | Perm. Wetland Impact        | [Circular pattern]      | Perm. Stream Buffer Impact     |
| --- --- | Wetland Boundary  | ----- | 200-Foot Shoreline Zone   | [Diagonal cross-hatch] | Temp. Wetland Impact        | [Circular pattern]      | Temp. Stream Buffer Impact     |
| ---     | Wetland Buffer    | ----- | Right of Way              | [Dotted pattern]       | Perm. Wetland Buffer Impact | [Diagonal cross-hatch]  | Temp. Shoreline Setback Impact |
| ---     | Stream Buffer     | ----- | Retaining Walls           | [Star pattern]         | Temp. Wetland Buffer Impact | [Diagonal cross-hatch]  | Perm. Shoreline Setback Impact |
| ---     | Stream OHWM       | ----- | Fill Limit                | [Star pattern]         | Temp. Wetland Buffer Impact | [Diagonal cross-hatch]  | Temp. Stream Impact            |
| ---     | Stream Centerline | ----- | Cut Limit                 | ---                    | CG---CG                     | Clearing/Grubbing Limit |                                |
| ---     | Ditch             | ---   |                           |                        |                             |                         |                                |
| ---     | Lake OHWM         | ---   |                           |                        |                             |                         |                                |



**Figure 2**  
**Critical Area Impacts**  
 East Lake Sammamish Trail  
 South Sammamish Segment B

Exhibit 16  
 SSDP-2016-00413  
 09/13/26

FILE: BL1521075P19T09F-01 LAYOUT: F3 PATH: U:\PSO\Projects\Clients\1521-KingCo\_564-1521-075-ELST\_995Sec\CADD\Phase 19\Task 09\SEC B PLOTTED BY: purgabot DATE: Friday, July 07, 2017 12:27:43 PM

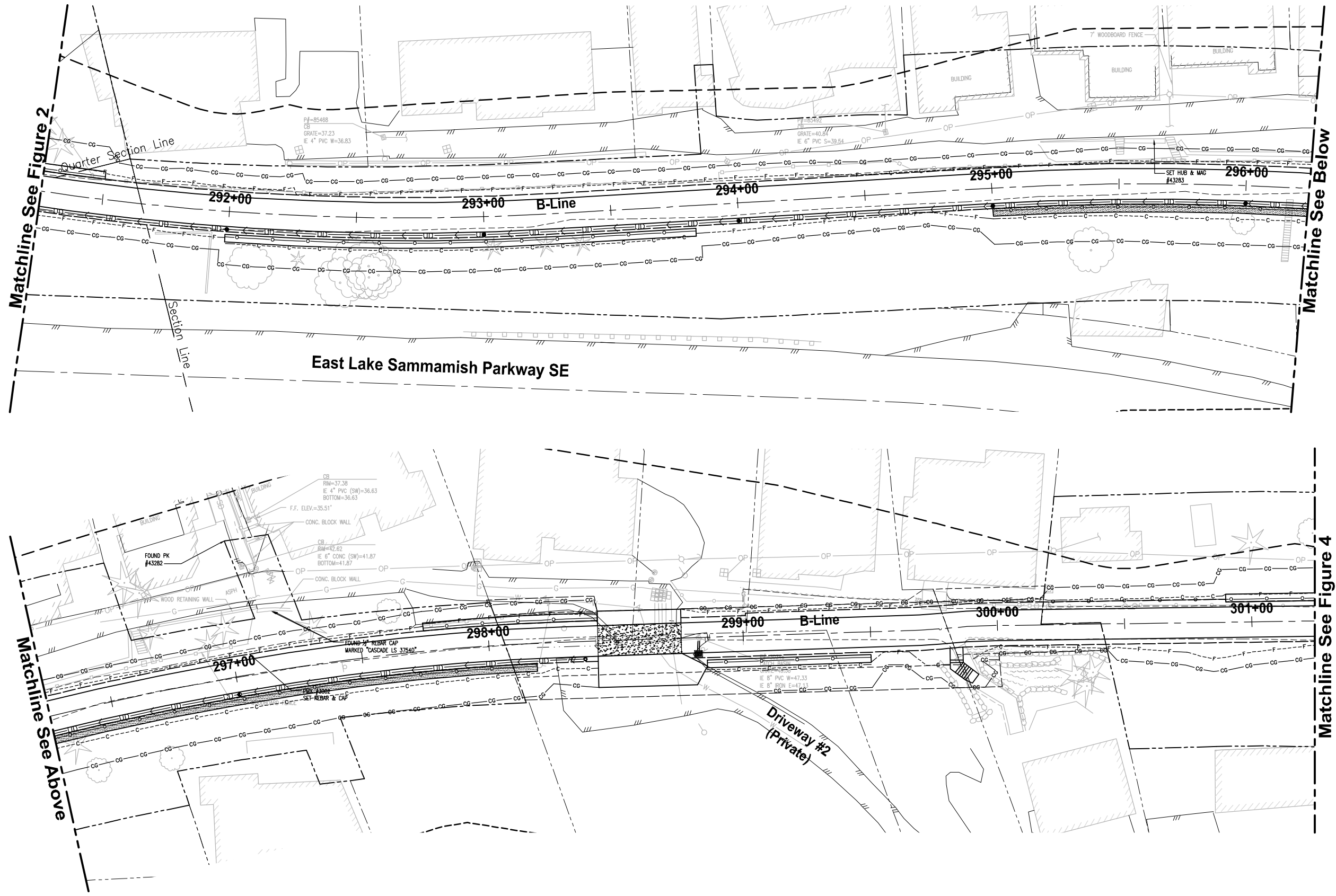

Parametrix DATE: July 7, 2017 FILE: BL1521075P19T09F-01

**Legend:**

- |         |                   |     |                           |                                |                             |                           |                                |
|---------|-------------------|-----|---------------------------|--------------------------------|-----------------------------|---------------------------|--------------------------------|
| 10C-SP2 | Data Plot         | --- | 50-Foot Shoreline Setback | [Cross-hatch pattern]          | Perm. Wetland Impact        | [Circular pattern]        | Perm. Stream Buffer Impact     |
| --- --- | Wetland Boundary  | --- | 200-Foot Shoreline Zone   | [Diagonal cross-hatch pattern] | Temp. Wetland Impact        | [Hexagonal pattern]       | Temp. Stream Buffer Impact     |
| ---     | Wetland Buffer    | --- | Right of Way              | [Dotted pattern]               | Perm. Wetland Buffer Impact | [Horizontal line pattern] | Temp. Shoreline Setback Impact |
| ---     | Stream Buffer     | --- | Retaining Walls           | [Star pattern]                 | Temp. Wetland Buffer Impact | [Vertical line pattern]   | Perm. Shoreline Setback Impact |
| ---     | Stream OHWM       | --- | Fill Limit                | [Dashed line pattern]          | ---                         | ---                       | ---                            |
| ---     | Stream Centerline | --- | Cut Limit                 | ---                            | ---                         | ---                       | ---                            |
| ---     | Ditch             | --- | Clearing/Grubbing Limit   | ---                            | ---                         | ---                       | ---                            |
| ---     | Lake OHWM         | --- | ---                       | ---                            | ---                         | ---                       | ---                            |



**Figure 3**  
**Critical Area Impacts**  
East Lake Sammamish Trail  
South Sammamish Segment B

Exhibit 16  
SSD-2016-00413  
09/13/27

FILE: BL1521075P19T09F-01 LAYOUT: F.4 PATH: U:\PSO\Projects\Clients\1521-KingCo\_564-1521-075-ELST\995ves\CADD\Phase 19\Task 09\SEC B PLOTTED BY: purgabot DATE: Friday, July 07, 2017 12:28:08 PM

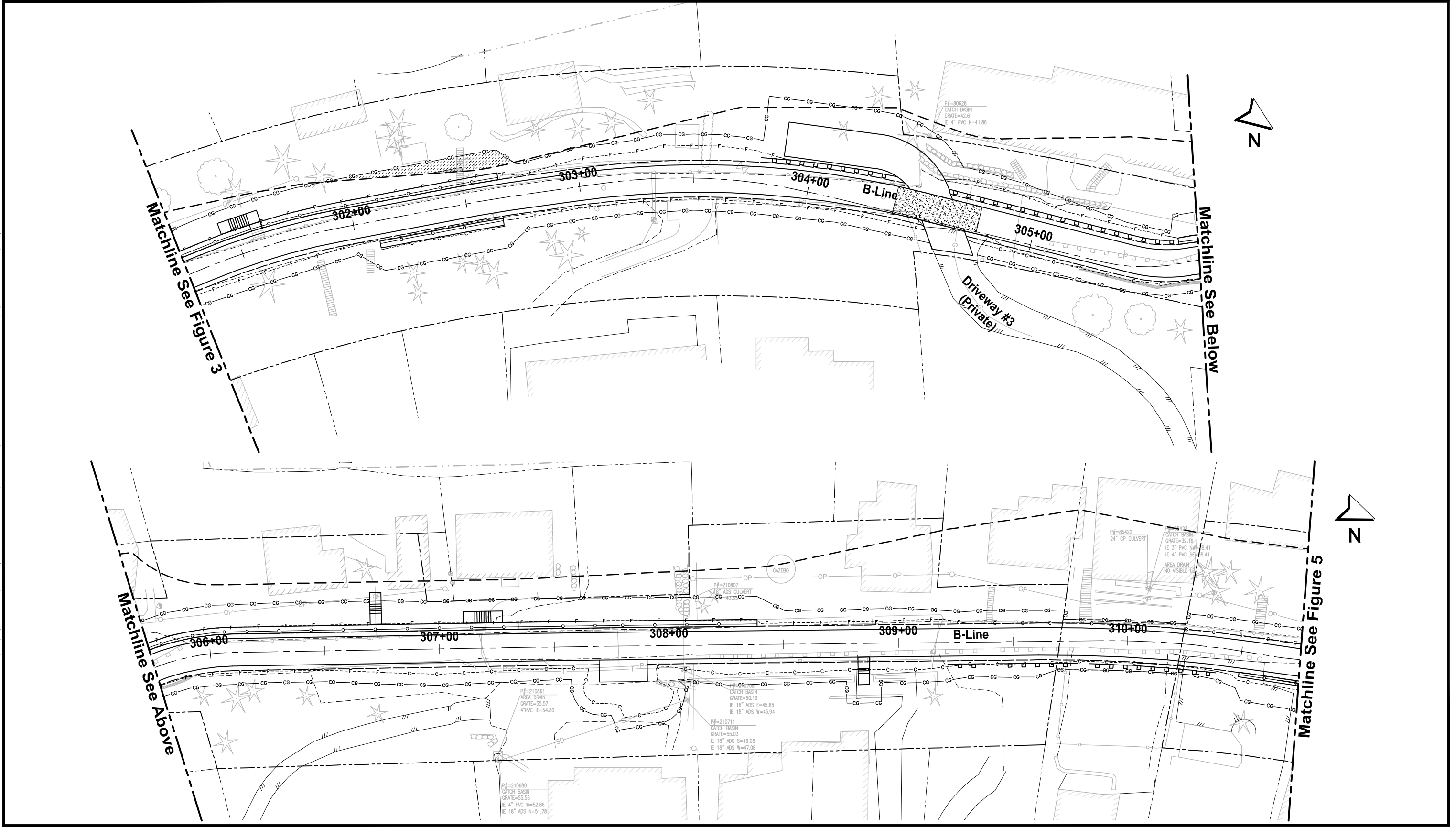

Parametrix DATE: July 7, 2017 FILE: BL1521075P19T09F-01

**Legend:**

- |               |                   |     |                           |                        |                      |                     |                                |
|---------------|-------------------|-----|---------------------------|------------------------|----------------------|---------------------|--------------------------------|
| 10C-SP2       | Data Plot         | --- | 50-Foot Shoreline Setback | [Cross-hatch pattern]  | Perm. Wetland Impact | [Circular pattern]  | Perm. Stream Buffer Impact     |
| [Wavy line]   | Wetland Boundary  | --- | 200-Foot Shoreline Zone   | [Diagonal cross-hatch] | Temp. Wetland Impact | [Circular pattern]  | Temp. Stream Buffer Impact     |
| [Dashed line] | Wetland Buffer    | --- | Right of Way              | [Solid line]           | Retaining Walls      | [Diagonal hatching] | Temp. Shoreline Setback Impact |
| [Dotted line] | Stream Buffer     | --- | Fill Limit                | [Dashed line]          | Cut Limit            | [Diagonal hatching] | Perm. Shoreline Setback Impact |
| [Dotted line] | Stream OHWM       | --- | Clearing/Grubbing Limit   | [Dotted line]          |                      | [Diagonal hatching] | Temp. Stream Impact            |
| [Dotted line] | Stream Centerline |     |                           |                        |                      |                     |                                |
| [Dotted line] | Ditch             |     |                           |                        |                      |                     |                                |
| [Dotted line] | Lake OHWM         |     |                           |                        |                      |                     |                                |



**Figure 4**  
**Critical Area Impacts**  
 East Lake Sammamish Trail  
 South Sammamish Segment B

Exhibit 16  
 SSDP 2016-00413  
 091328

FILE: BL1521075P19T09F-01 LAYOUT: F5 PATH: U:\PSO\Projects\Clients\1521-KingCo\_564-1521-075-ELI\995ves\CADD\Phase 19\Task 09\SEG B PLOTTED BY: purgabot DATE: Friday, July 07, 2017 12:28:34 PM

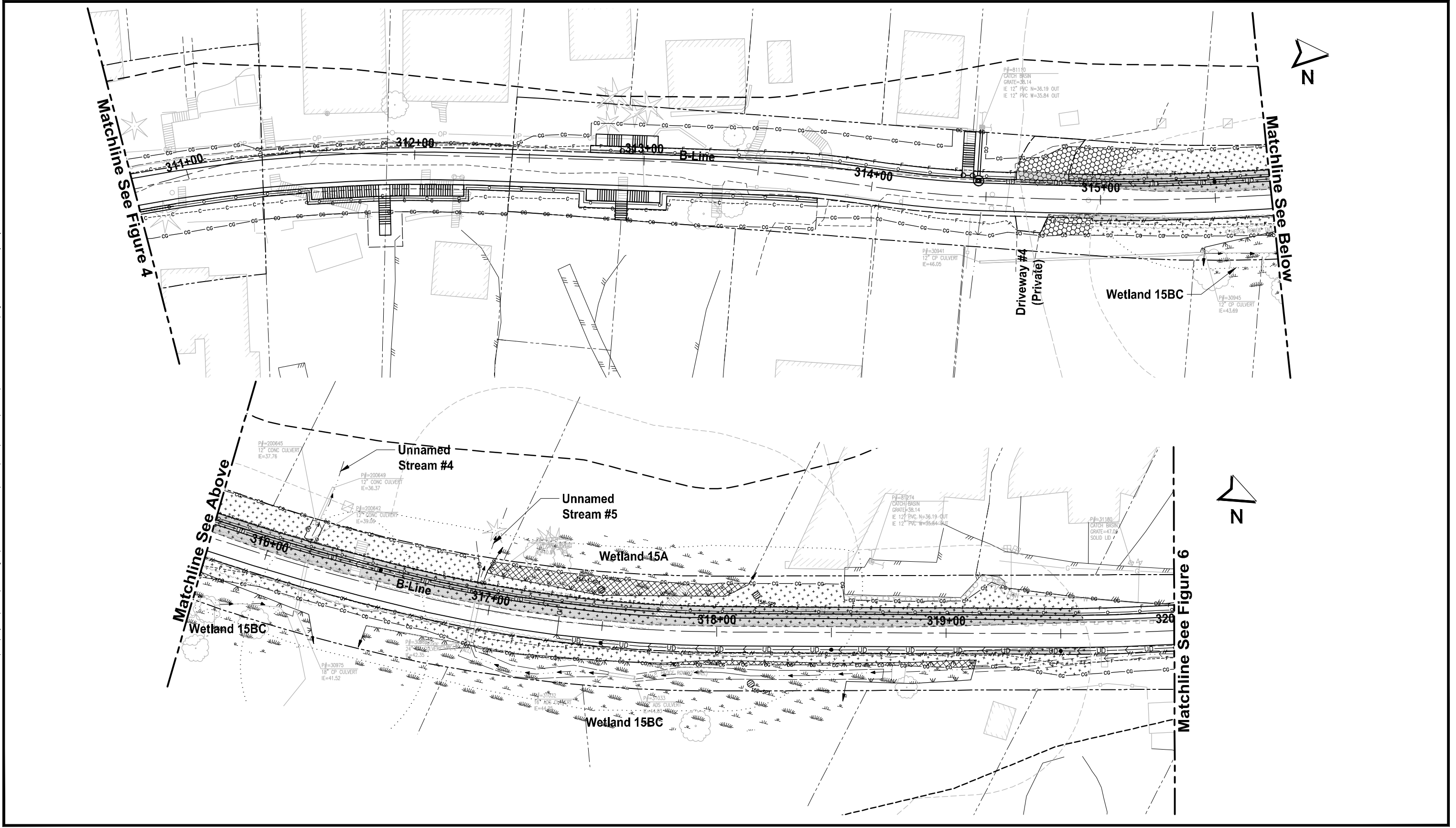

Parametrix DATE: July 7, 2017 FILE: BL1521075P19T09F-01



**Legend:**

	Data Plot		50-Foot Shoreline Setback		Perm. Wetland Impact		Perm. Stream Buffer Impact
	Wetland Boundary		200-Foot Shoreline Zone		Temp. Wetland Impact		Temp. Stream Buffer Impact
	Wetland Buffer		Right of Way		Perm. Wetland Buffer Impact		Temp. Shoreline Setback Impact
	Stream Buffer		Retaining Walls		Temp. Wetland Buffer Impact		Perm. Shoreline Setback Impact
	Stream OHWM		Fill Limit		Cut Limit		Temp. Stream Impact
	Stream Centerline		Clearing/Grubbing Limit				
	Ditch						
	Lake OHWM						

**Figure 5**  
**Critical Area Impacts**  
 East Lake Sammamish Trail  
 South Sammamish Segment B

Exhibit 16  
 SSDP 2016-00413  
 09/13/25

FILE: BL1521075P19T09F-01 LAYOUT: F6 PATH: U:\PSO\Projects\Clients\1521-KingCo\_564-1521-075-ELST\99Sves\CADD\Phase 19\Task 09\SEC B PLOTTED BY: purgabot DATE: Friday, July 07, 2017 12:28:57 PM

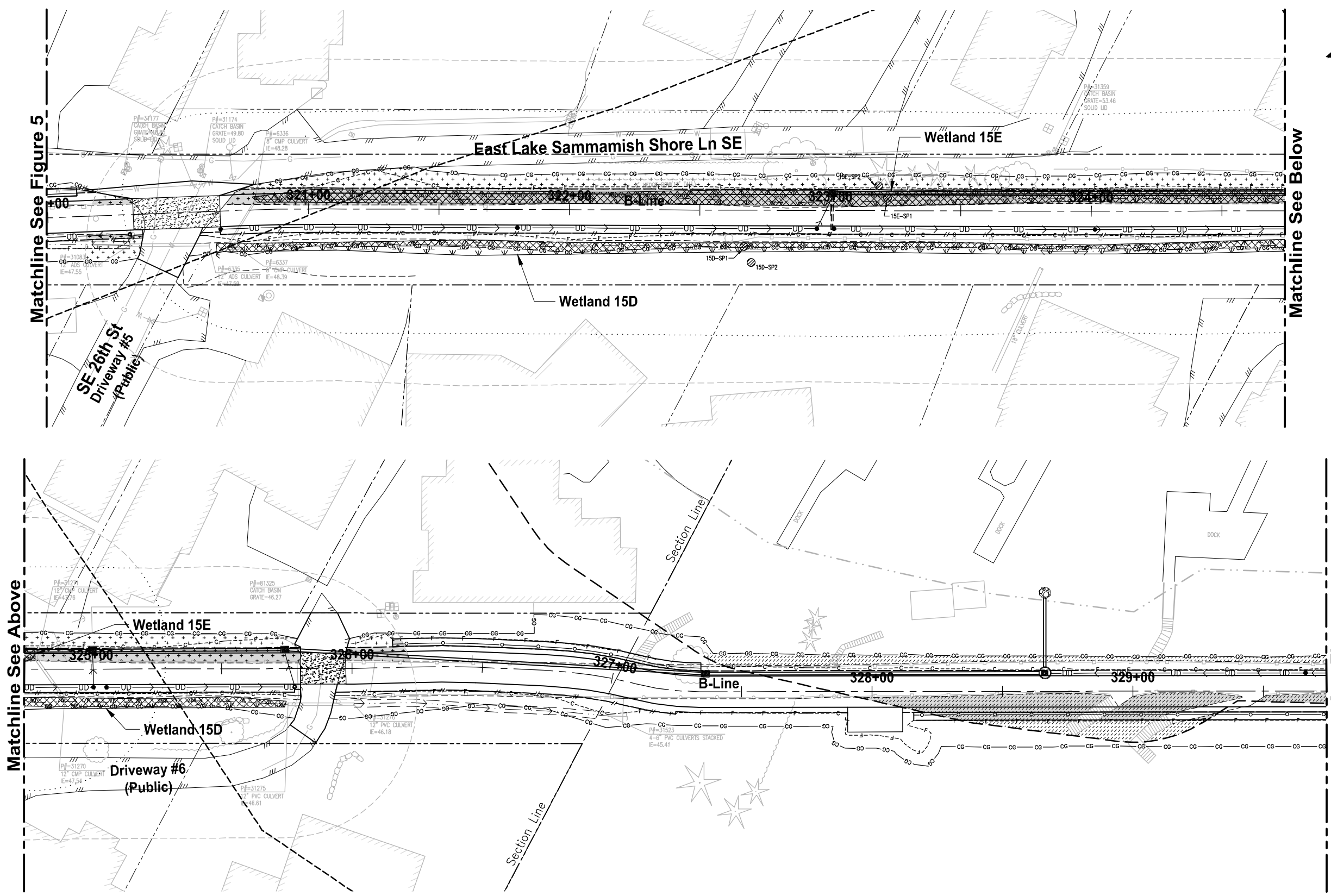

Parametrix DATE: July 7, 2017 FILE: BL1521075P19T09F-01

**Legend:**

- |         |                   |       |                           |                                |                             |                   |                                |
|---------|-------------------|-------|---------------------------|--------------------------------|-----------------------------|-------------------|--------------------------------|
| 10C-SP2 | Data Plot         | ----- | 50-Foot Shoreline Setback | [Cross-hatch pattern]          | Perm. Wetland Impact        | [Hexagon pattern] | Perm. Stream Buffer Impact     |
| -----   | Wetland Boundary  | ----- | 200-Foot Shoreline Zone   | [Diagonal cross-hatch pattern] | Temp. Wetland Impact        | [Hexagon pattern] | Temp. Stream Buffer Impact     |
| -----   | Wetland Buffer    | ----- | Right of Way              | [Dotted pattern]               | Perm. Wetland Buffer Impact | [Diagonal lines]  | Temp. Shoreline Setback Impact |
| -----   | Stream Buffer     | ----- | Retaining Walls           | [Star pattern]                 | Temp. Wetland Buffer Impact | [Diagonal lines]  | Perm. Shoreline Setback Impact |
| -----   | Stream OHWM       | ----- | Fill Limit                | -----                          | -----                       | -----             | -----                          |
| -----   | Stream OHWM       | ----- | Cut Limit                 | -----                          | -----                       | -----             | -----                          |
| -----   | Stream Centerline | ----- | Clearing/Grubbing Limit   | -----                          | -----                       | -----             | -----                          |
| -----   | Ditch             | ----- | -----                     | -----                          | -----                       | -----             | -----                          |
| -----   | Lake OHWM         | ----- | -----                     | -----                          | -----                       | -----             | -----                          |



**Figure 6**  
**Critical Area Impacts**  
 East Lake Sammamish Trail  
 South Sammamish Segment B

Exhibit 16  
 SSDP-2016-00413  
 091036

FILE: BL1521075P19T09F-02 LAYOUT: F7 PATH: U:\PSC\Projects\Clients\1521-KingCo\564-1521-075-ELST\995secs\CADD\Phase 19\Task 09\SEC B PLOTTED BY: purgabut DATE: Friday, July 07, 2017 12:30:16 PM

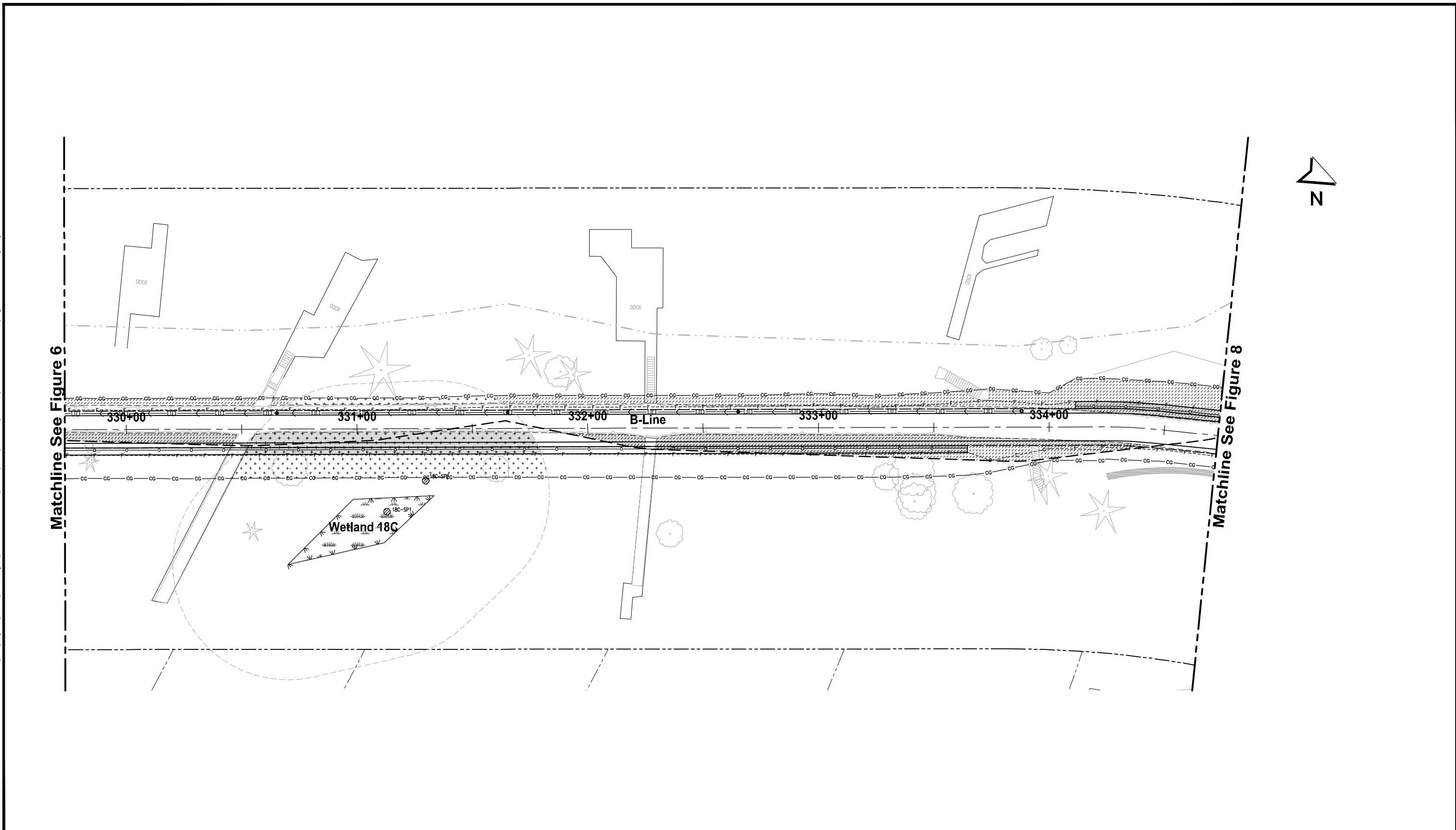

Parametrix DATE: July 7, 2017 FILE: BL1521075P19T09F-02

**Legend:**

- 10C-SP2 Data Plot
- Wetland Boundary
- Wetland Buffer
- Stream Buffer
- Stream OHWM
- Stream Centerline
- Ditch
- Lake OHWM

- 50-Foot Shoreline Setback
- 200-Foot Shoreline Zone
- Right of Way
- Retaining Walls
- Fill Limit
- Cut Limit
- Clearing/Grubbing Limit

- Perm. Wetland Impact
- Temp. Wetland Impact
- Perm. Wetland Buffer Impact
- Temp. Wetland Buffer Impact

- Perm. Stream Buffer Impact
- Temp. Stream Buffer Impact
- Temp. Shoreline Setback Impact
- Perm. Shoreline Setback Impact
- Temp. Stream Impact

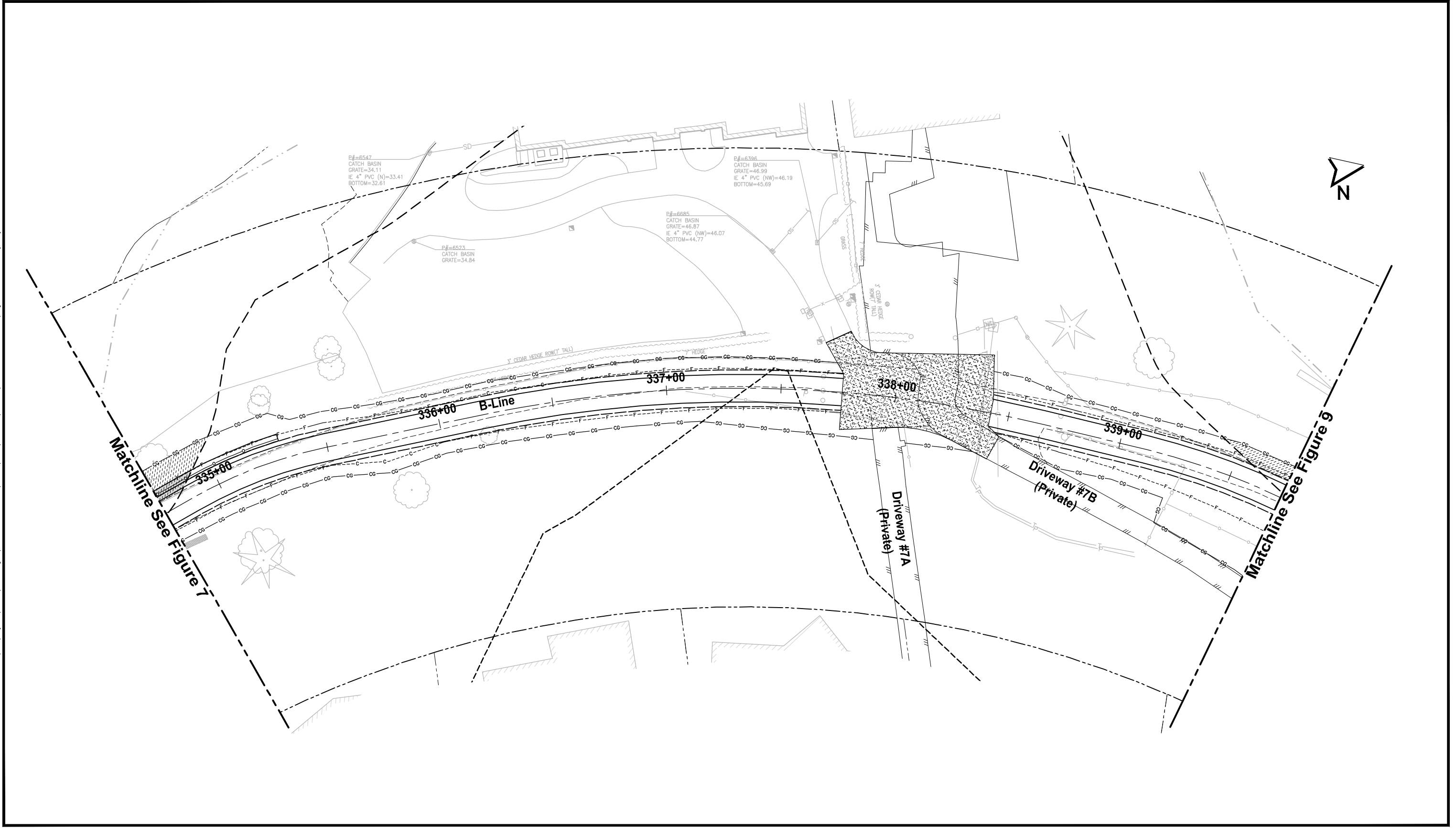

**Figure 7**  
**Critical Area Impacts**  
 East Lake Sammamish Trail  
 South Sammamish Segment B

Exhibit 16  
 SSDP-2016-00413  
 09/13/17



FILE: BL1521075P19T09F-02 LAYOUT: FB PATH: U:\PSC\Projects\Clients\1521-075-ELST\995Secs\CAAD\Phase 19\Task 09\SEC B PLOTTED BY: purgabou DATE: Friday, July 07, 2017 12:30:36 PM



Parametrix DATE: July 7, 2017 FILE: BL1521075P19T09F-02

**Legend:**

- |         |                   |       |                           |               |                             |            |                                |
|---------|-------------------|-------|---------------------------|---------------|-----------------------------|------------|--------------------------------|
| 10C-SP2 | Data Plot         | ----- | 50-Foot Shoreline Setback | [Cross-hatch] | Perm. Wetland Impact        | [Grid]     | Perm. Stream Buffer Impact     |
| --- --- | Wetland Boundary  | ----- | 200-Foot Shoreline Zone   | [Diagonal]    | Temp. Wetland Impact        | [Grid]     | Temp. Stream Buffer Impact     |
| -----   | Wetland Buffer    | ----- | Right of Way              | [Dotted]      | Perm. Wetland Buffer Impact | [Diagonal] | Temp. Shoreline Setback Impact |
| -----   | Stream Buffer     | ----- | Retaining Walls           | [Star]        | Temp. Wetland Buffer Impact | [Diagonal] | Perm. Shoreline Setback Impact |
| -----   | Stream OHWM       | ----- | Fill Limit                | [Star]        |                             | [Diagonal] | Temp. Stream Impact            |
| -----   | Stream Centerline | ----- | Cut Limit                 |               |                             |            |                                |
| -----   | Ditch             | ----- | Clearing/Grubbing Limit   |               |                             |            |                                |
| -----   | Lake OHWM         |       |                           |               |                             |            |                                |



**Figure 8**  
**Critical Area Impacts**  
 East Lake Sammamish Trail  
 South Sammamish Segment B

Exhibit 16  
 SSD-2016-00413  
 09/13/17

FILE: BL1521075P19T09F-02 LAYOUT: F9 PATH: U:\PSC\Projects\Clients\1521-075-ELST\995secs\CAAD\Phase 19\Task 09\SEG B PLOTTED BY: purgabot DATE: Friday, July 07, 2017 12:31:04 PM

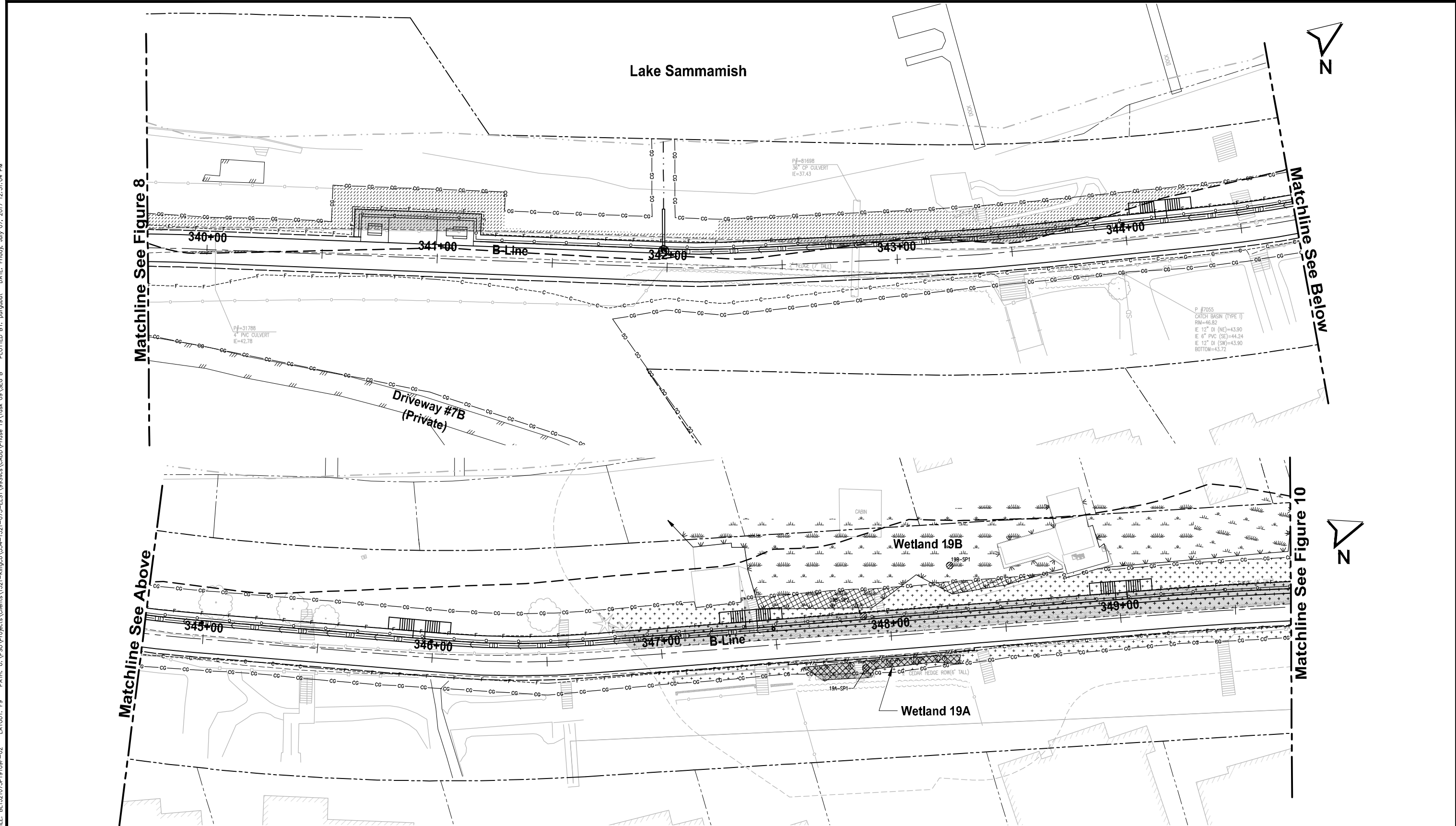

Parametrix DATE: July 7, 2017 FILE: BL1521075P19T09F-02

**Legend:**

- |               |                   |              |                           |                  |                             |                  |                                |
|---------------|-------------------|--------------|---------------------------|------------------|-----------------------------|------------------|--------------------------------|
| 10C-SP2       | Data Plot         | ---          | 50-Foot Shoreline Setback | [Cross-hatch]    | Perm. Wetland Impact        | [Diagonal lines] | Perm. Stream Buffer Impact     |
| [Wavy line]   | Wetland Boundary  | ---          | 200-Foot Shoreline Zone   | [Diagonal lines] | Temp. Wetland Impact        | [Diagonal lines] | Temp. Stream Buffer Impact     |
| [Dashed line] | Wetland Buffer    | ---          | Right of Way              | [Dotted]         | Perm. Wetland Buffer Impact | [Diagonal lines] | Temp. Shoreline Setback Impact |
| [Dashed line] | Stream Buffer     | [Solid line] | Retaining Walls           | [Dotted]         | Temp. Wetland Buffer Impact | [Diagonal lines] | Perm. Shoreline Setback Impact |
| [Dashed line] | Stream OHWM       | ---          | Fill Limit                | [Dotted]         | Temp. Wetland Buffer Impact | [Diagonal lines] | Temp. Stream Impact            |
| [Dashed line] | Stream Centerline | ---          | Cut Limit                 | [Dotted]         |                             |                  |                                |
| [Dashed line] | Ditch             | ---          | Clearing/Grubbing Limit   |                  |                             |                  |                                |
| [Dashed line] | Lake OHWM         |              |                           |                  |                             |                  |                                |



**Figure 9**  
**Critical Area Impacts**  
 East Lake Sammamish Trail  
 South Sammamish Segment B

Exhibit 16  
 SSDP-2016-00415  
 091033

FILE: BL1521075P19T09F-02 LAYOUT: F10 PATH: U:\P50\Projects\Clients\1521-KingCo\554-1521-075-ELST\955vcs\CAOD\Phase 19\Task 09\SEG B PLOTTED BY: purgobut DATE: Friday, July 07, 2017 12:31:35 PM

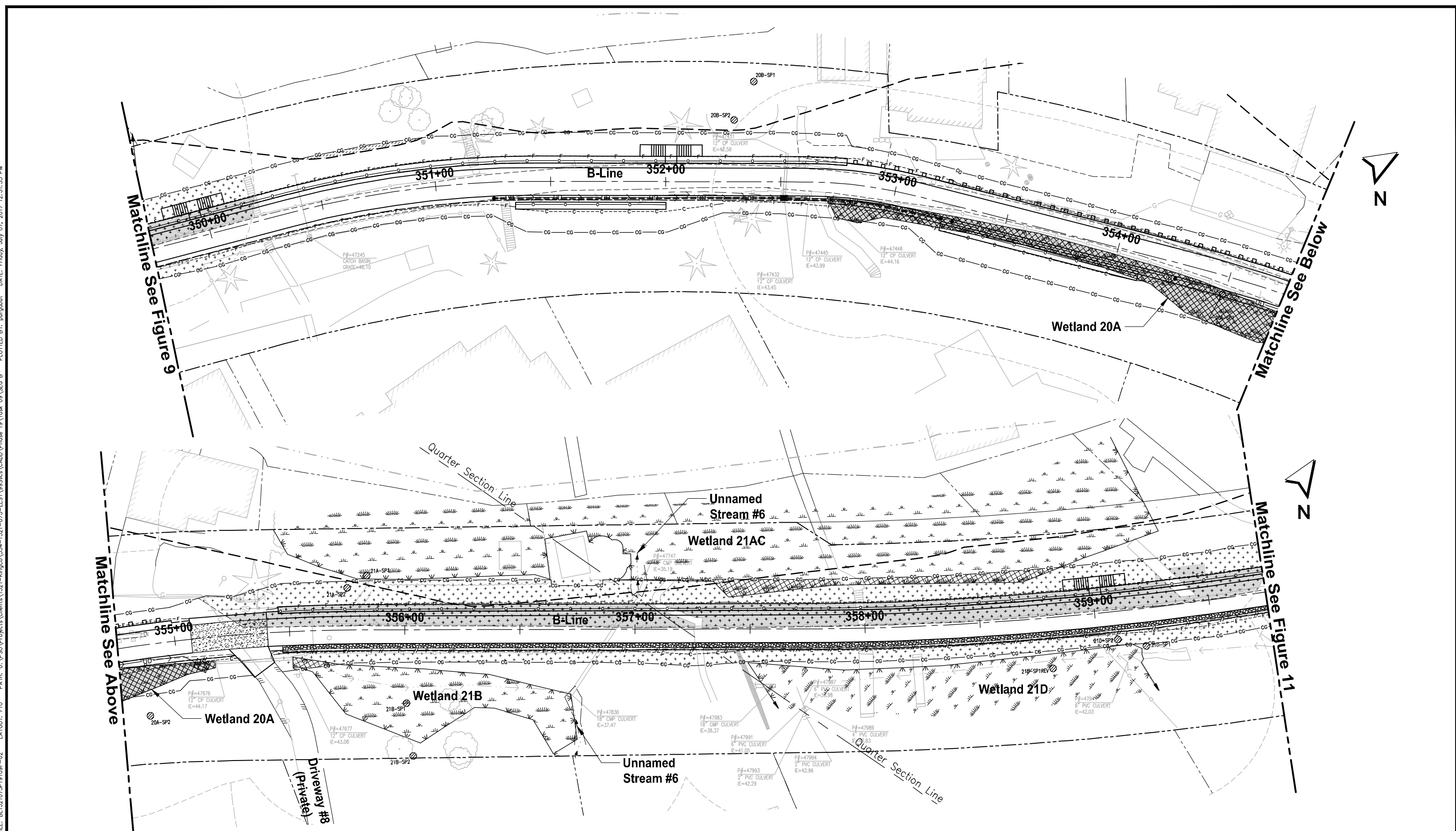

Parametrix DATE: July 7, 2017 FILE: BL1521075P19T09F-02



**Legend:**

- |                            |                   |       |                           |                                |                             |                     |                                |
|----------------------------|-------------------|-------|---------------------------|--------------------------------|-----------------------------|---------------------|--------------------------------|
| 10C-SP2                    | Data Plot         | ----- | 50-Foot Shoreline Setback | [Cross-hatch pattern]          | Perm. Wetland Impact        | [Circular pattern]  | Perm. Stream Buffer Impact     |
| [Wetland boundary symbol]  | Wetland Boundary  | ----- | 200-Foot Shoreline Zone   | [Diagonal cross-hatch pattern] | Temp. Wetland Impact        | [Circular pattern]  | Temp. Stream Buffer Impact     |
| [Wetland buffer symbol]    | Wetland Buffer    | ----- | Right of Way              | [Dotted pattern]               | Perm. Wetland Buffer Impact | [Diagonal hatching] | Temp. Shoreline Setback Impact |
| [Stream buffer symbol]     | Stream Buffer     | ----- | Retaining Walls           | [Star pattern]                 | Temp. Wetland Buffer Impact | [Diagonal hatching] | Perm. Shoreline Setback Impact |
| [Stream OHWM symbol]       | Stream OHWM       | ----- | Fill Limit                | [Star pattern]                 |                             | [Diagonal hatching] | Temp. Stream Impact            |
| [Stream centerline symbol] | Stream Centerline | ----- | Cut Limit                 | [Star pattern]                 |                             |                     |                                |
| [Ditch symbol]             | Ditch             | ----- | Clearing/Grubbing Limit   |                                |                             |                     |                                |
| [Lake OHWM symbol]         | Lake OHWM         |       |                           |                                |                             |                     |                                |

**Figure 10**  
**Critical Area Impacts**  
 East Lake Sammamish Trail  
 South Sammamish Segment B

Exhibit 16  
 SSDP 2016-00413  
 091034

FILE: BL1521075P19T09F-02 LAYOUT: F11 PATH: U:\PSO\Projects\Clients\1521-075-ELST\995\cs\CADD\Phase 19\Task 09\SEG B PLOTTED BY: purgubut DATE: Friday, July 07, 2017 12:32:05 PM

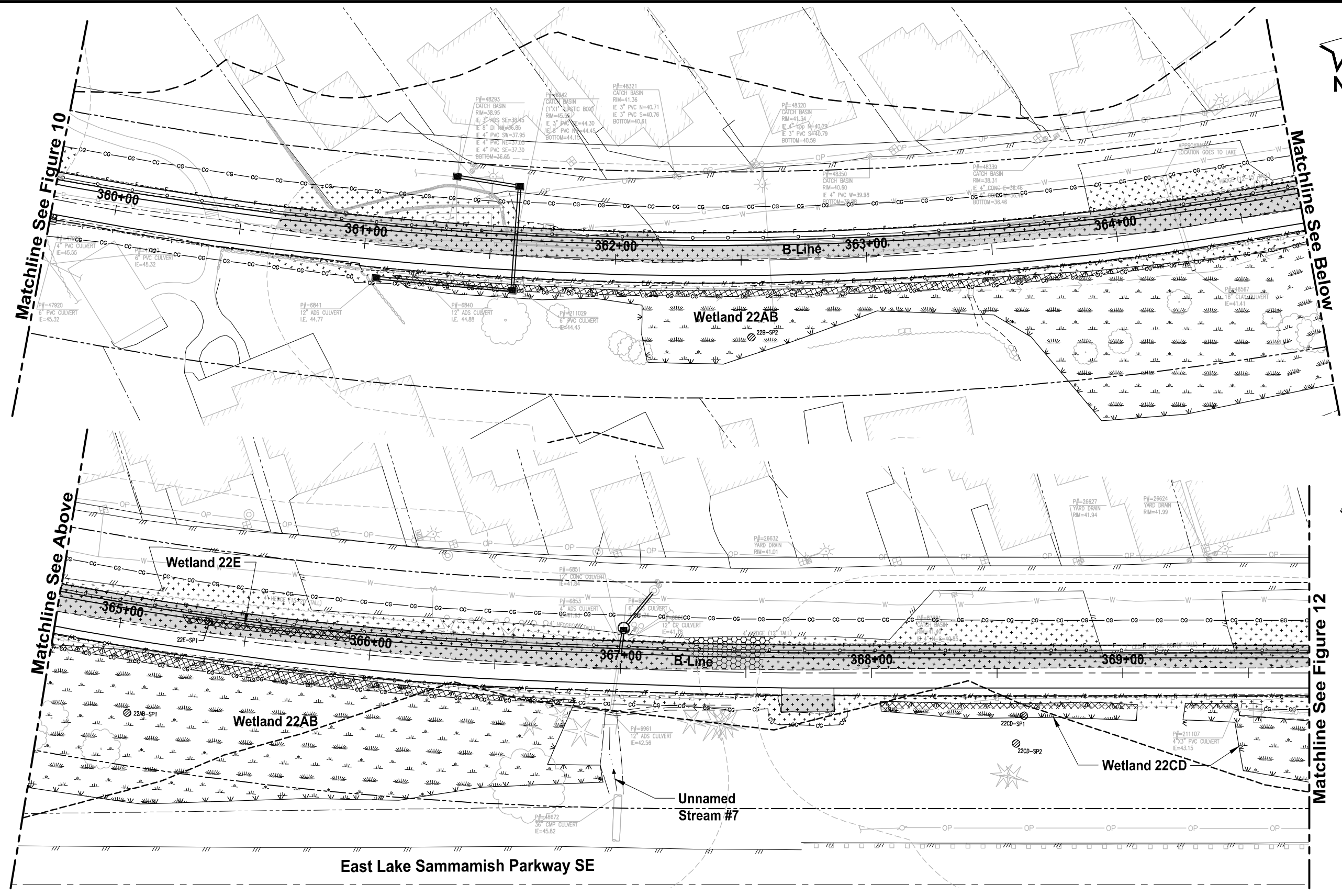

Parametrix DATE: July 7, 2017 FILE: BL1521075P19T09F-02

**Legend:**

- |                  |                   |       |                           |                       |                             |                   |                                |
|------------------|-------------------|-------|---------------------------|-----------------------|-----------------------------|-------------------|--------------------------------|
| 10C-SP2          | Data Plot         | ----- | 50-Foot Shoreline Setback | [Cross-hatch pattern] | Perm. Wetland Impact        | [Hexagon pattern] | Perm. Stream Buffer Impact     |
| [Wetland symbol] | Wetland Boundary  | ----- | 200-Foot Shoreline Zone   | [Diagonal lines]      | Temp. Wetland Impact        | [Hexagon pattern] | Temp. Stream Buffer Impact     |
| [Wetland symbol] | Wetland Buffer    | ----- | Right of Way              | [Dotted pattern]      | Perm. Wetland Buffer Impact | [Diagonal lines]  | Temp. Shoreline Setback Impact |
| [Wetland symbol] | Stream Buffer     | ----- | Retaining Walls           | [Dotted pattern]      | Temp. Wetland Buffer Impact | [Diagonal lines]  | Perm. Shoreline Setback Impact |
| [Wetland symbol] | Stream OHWM       | ----- | Fill Limit                | [Dotted pattern]      |                             | [Diagonal lines]  | Temp. Stream Impact            |
| [Wetland symbol] | Stream Centerline | ----- | Cut Limit                 | [Dotted pattern]      |                             |                   |                                |
| [Wetland symbol] | Ditch             | ----- | Clearing/Grubbing Limit   |                       |                             |                   |                                |
| [Wetland symbol] | Lake OHWM         | ----- |                           |                       |                             |                   |                                |



**Figure 11**  
**Critical Area Impacts**  
 East Lake Sammamish Trail  
 South Sammamish Segment B

Exhibit 16  
 SDDP 2016-00415  
 091035

FILE: BL1521075P19T09F-03 LAYOUT: F12 PATH: U:\PSO\Projects\Clients\1521-KingCo\1554-1521-075-ELST\955vcs\CAAD\Phase 19\Task 09\SEG B PLOTTED BY: purgobut DATE: Friday, July 07, 2017 12:33:36 PM

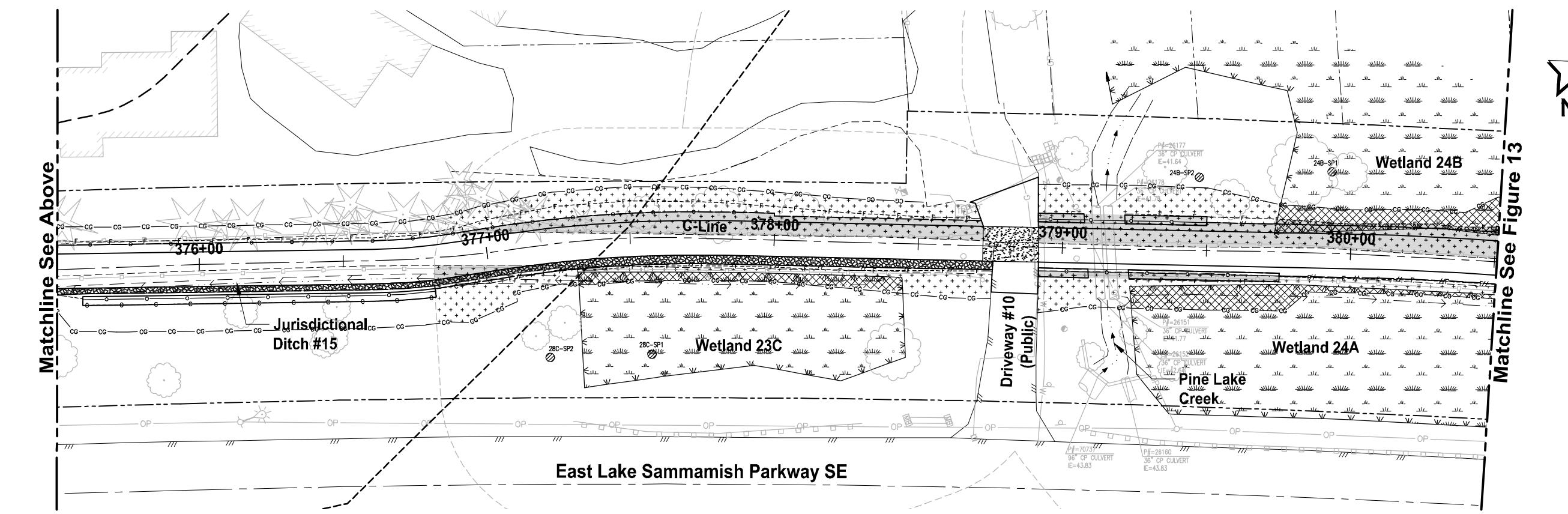
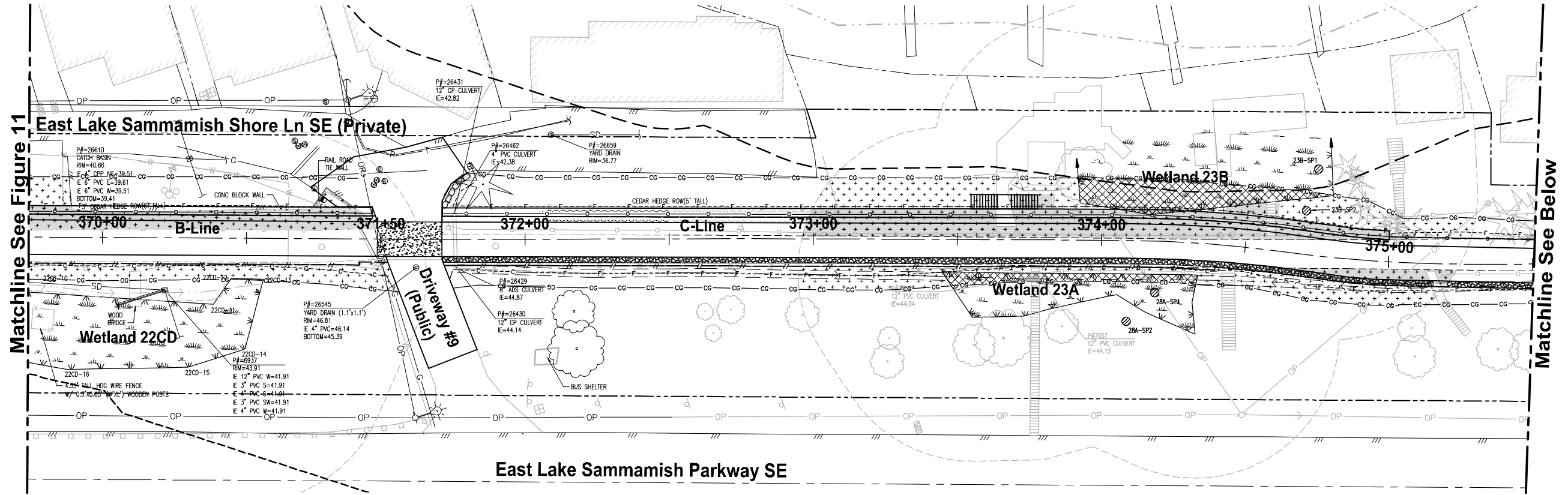

Parametrix DATE: July 7, 2017 FILE: BL1521075P19T09F-03

**Legend:**

- |         |                   |     |                           |                                |                             |                    |                                |
|---------|-------------------|-----|---------------------------|--------------------------------|-----------------------------|--------------------|--------------------------------|
| 10C-SP2 | Data Plot         | --- | 50-Foot Shoreline Setback | [Cross-hatch pattern]          | Perm. Wetland Impact        | [Circular pattern] | Perm. Stream Buffer Impact     |
| --- --- | Wetland Boundary  | --- | 200-Foot Shoreline Zone   | [Diagonal cross-hatch pattern] | Temp. Wetland Impact        | [Circular pattern] | Temp. Stream Buffer Impact     |
| ---     | Wetland Buffer    | --- | Right of Way              | [Stippled pattern]             | Perm. Wetland Buffer Impact | [Diagonal lines]   | Temp. Shoreline Setback Impact |
| ---     | Stream Buffer     | --- | Retaining Walls           | [Stippled pattern]             | Temp. Wetland Buffer Impact | [Diagonal lines]   | Perm. Shoreline Setback Impact |
| ---     | Stream OHWM       | --- | Fill Limit                | [Stippled pattern]             |                             | [Diagonal lines]   | Temp. Stream Impact            |
| ---     | Stream Centerline | --- | Cut Limit                 | [Stippled pattern]             |                             |                    |                                |
| ---     | Ditch             | --- | Clearing/Grubbing Limit   |                                |                             |                    |                                |
| ---     | Lake OHWM         |     |                           |                                |                             |                    |                                |



**Figure 12**  
**Critical Area Impacts**  
 East Lake Sammamish Trail  
 South Sammamish Segment B

Exhibit 16  
 SSDP 2016-00413  
 091036

FILE: BL1521075P19T09F-03 LAYOUT: F13 PATH: U:\P50\Projects\Clients\1521-KingCo\554-1521-075-ELST\955\3\CAAD\Phase 19\Task 09\SEG B PLOTTED BY: purgobut DATE: Friday, July 07, 2017 12:34:05 PM

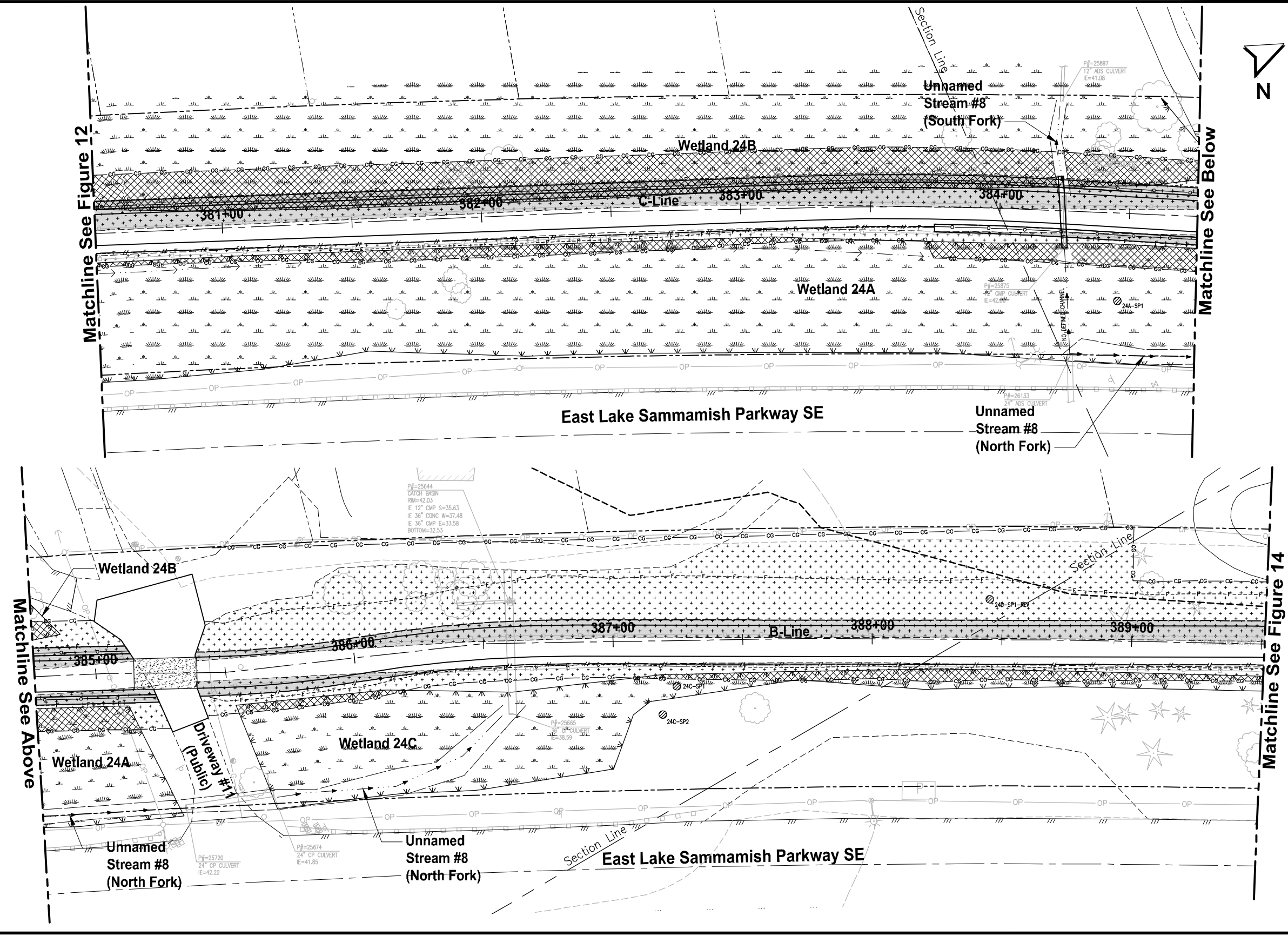

Parametrix DATE: July 7, 2017 FILE: BL1521075P19T09F-03

**Legend:**

- |         |                   |       |                           |                   |                             |                   |                                |
|---------|-------------------|-------|---------------------------|-------------------|-----------------------------|-------------------|--------------------------------|
| 10C-SP2 | Data Plot         | ----- | 50-Foot Shoreline Setback | [Hatched Pattern] | Perm. Wetland Impact        | [Hatched Pattern] | Perm. Stream Buffer Impact     |
| -----   | Wetland Boundary  | ----- | 200-Foot Shoreline Zone   | [Hatched Pattern] | Temp. Wetland Impact        | [Hatched Pattern] | Temp. Stream Buffer Impact     |
| -----   | Wetland Buffer    | ----- | Right of Way              | [Hatched Pattern] | Perm. Wetland Buffer Impact | [Hatched Pattern] | Temp. Shoreline Setback Impact |
| -----   | Stream Buffer     | ----- | Retaining Walls           | [Hatched Pattern] | Temp. Wetland Buffer Impact | [Hatched Pattern] | Perm. Shoreline Setback Impact |
| -----   | Stream OHWM       | ----- | Fill Limit                | [Hatched Pattern] |                             | [Hatched Pattern] | Temp. Stream Impact            |
| -----   | Stream Centerline | ----- | Cut Limit                 | [Hatched Pattern] |                             |                   |                                |
| -----   | Ditch             | ----- | Clearing/Grubbing Limit   |                   |                             |                   |                                |
| -----   | Lake OHWM         |       |                           |                   |                             |                   |                                |



**Figure 13**  
**Critical Area Impacts**  
 East Lake Sammamish Trail  
 South Sammamish Segment B

Exhibit 16  
 SSDP 2016-00413  
 09/13/17

FILE: BL1521075P19T09F-03 LAYOUT: F14 PATH: U:\P50\Projects\Clients\1521-KingCo\154-1521-075-ELST\955vcs\CAAD\Phase 19\Task 09\SEG B PLOTTED BY: purgubut DATE: Friday, July 07, 2017 12:34:35 PM

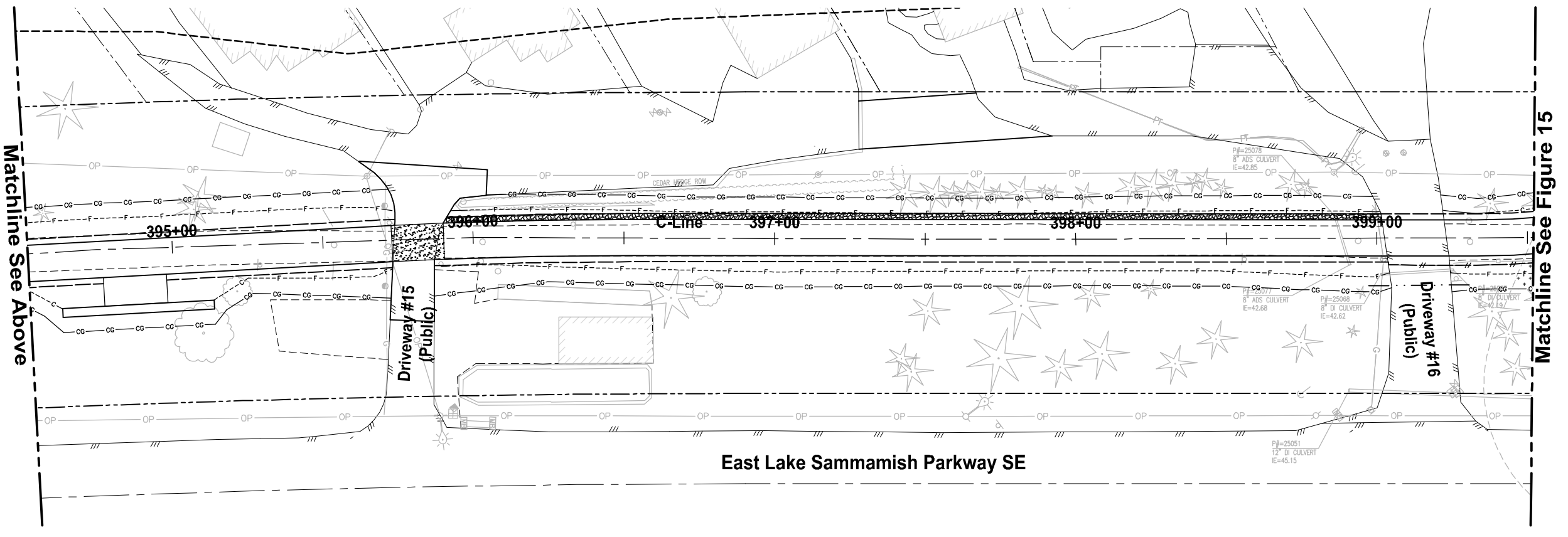
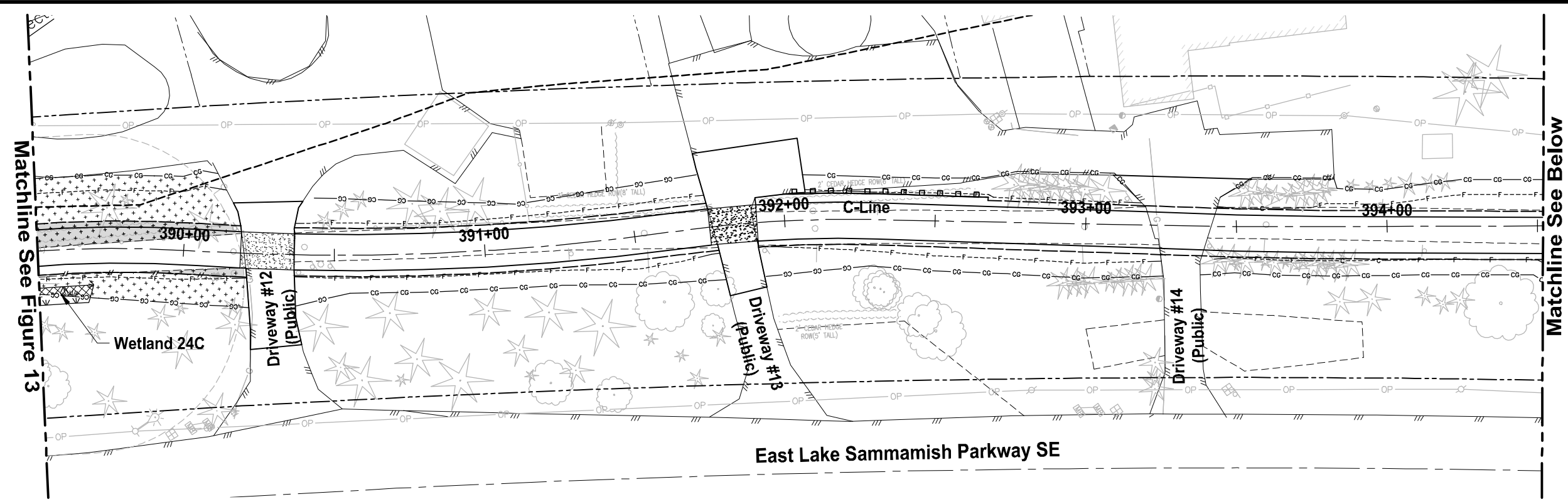

Parametrix DATE: July 7, 2017 FILE: BL1521075P19T09F-03

**Legend:**

- |             |                   |     |                           |                  |                             |                  |                                |
|-------------|-------------------|-----|---------------------------|------------------|-----------------------------|------------------|--------------------------------|
| 10C-SP2     | Data Plot         | --- | 50-Foot Shoreline Setback | [Cross-hatch]    | Perm. Wetland Impact        | [Dotted]         | Perm. Stream Buffer Impact     |
| [Wavy line] | Wetland Boundary  | --- | 200-Foot Shoreline Zone   | [Diagonal lines] | Temp. Wetland Impact        | [Dotted]         | Temp. Stream Buffer Impact     |
| ---         | Wetland Buffer    | --- | Right of Way              | [Solid]          | Perm. Wetland Buffer Impact | [Diagonal lines] | Temp. Shoreline Setback Impact |
| ---         | Stream Buffer     | --- | Retaining Walls           | ---              | Temp. Wetland Buffer Impact | [Diagonal lines] | Perm. Shoreline Setback Impact |
| ---         | Stream OHWM       | --- | Fill Limit                | ---              | ---                         | [Diagonal lines] | Temp. Stream Impact            |
| ---         | Stream Centerline | --- | Cut Limit                 | ---              | ---                         | ---              | ---                            |
| ---         | Ditch             | --- | Clearing/Grubbing Limit   | ---              | ---                         | ---              | ---                            |
| ---         | Lake OHWM         | --- | ---                       | ---              | ---                         | ---              | ---                            |



**Figure 14**  
**Critical Area Impacts**  
 East Lake Sammamish Trail  
 South Sammamish Segment B

FILE: BL1521075P19T09F-03 LAYOUT: F15 PATH: U:\PSO\Projects\Clients\1521-KingCo\554-1521-075-ELST\955vcs\CA0D\Phase 19\Task 09\SEG B PLOTTED BY: purgobut DATE: Friday, July 07, 2017 12:35:04 PM

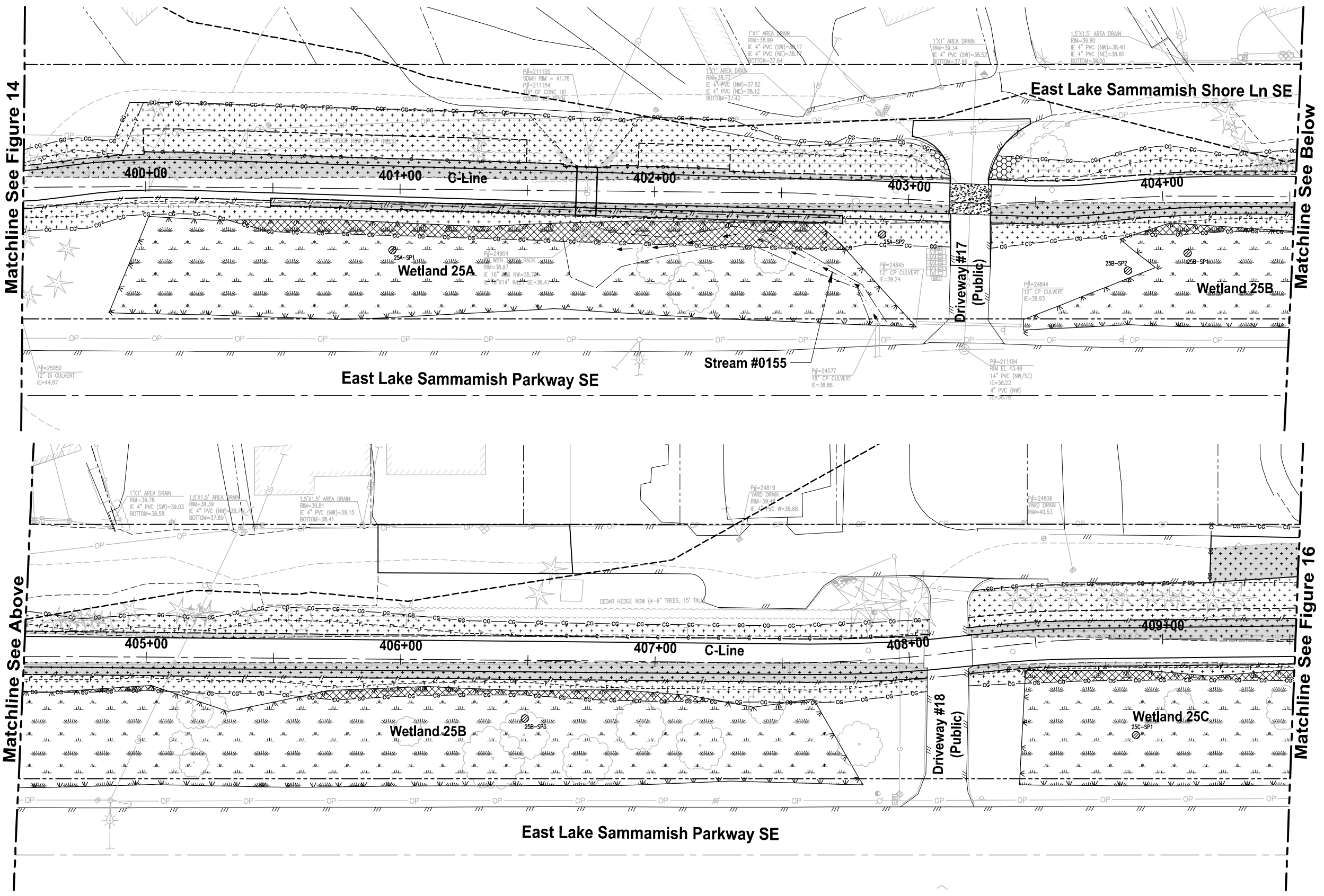

Matchline See Figure 14

Matchline See Below

Matchline See Above

Matchline See Figure 16

Parametrix DATE: July 7, 2017 FILE: BL1521075P19T09F-03

**Legend:**

- |               |                   |       |                           |                        |                             |                        |                                |
|---------------|-------------------|-------|---------------------------|------------------------|-----------------------------|------------------------|--------------------------------|
| 10C-SP2       | Data Plot         | ----- | 50-Foot Shoreline Setback | [Cross-hatch pattern]  | Perm. Wetland Impact        | [Hexagon pattern]      | Perm. Stream Buffer Impact     |
| [Wavy line]   | Wetland Boundary  | ----- | 200-Foot Shoreline Zone   | [Diagonal cross-hatch] | Temp. Wetland Impact        | [Hexagon pattern]      | Temp. Stream Buffer Impact     |
| [Dashed line] | Wetland Buffer    | ----- | Right of Way              | [Dotted pattern]       | Perm. Wetland Buffer Impact | [Diagonal cross-hatch] | Temp. Shoreline Setback Impact |
| [Dashed line] | Stream Buffer     | ----- | Retaining Walls           | [Star pattern]         | Temp. Wetland Buffer Impact | [Diagonal cross-hatch] | Perm. Shoreline Setback Impact |
| [Dashed line] | Stream OHWM       | ----- | Fill Limit                | [Dotted pattern]       |                             | [Diagonal cross-hatch] | Temp. Stream Impact            |
| [Dashed line] | Stream Centerline | ----- | Cut Limit                 | [Dotted pattern]       |                             |                        |                                |
| [Dashed line] | Ditch             | ----- | Clearing/Grubbing Limit   | [Dotted pattern]       |                             |                        |                                |
| [Dashed line] | Lake OHWM         | ----- |                           |                        |                             |                        |                                |



**Figure 15**  
**Critical Area Impacts**  
 East Lake Sammamish Trail  
 South Sammamish Segment B



FILE: BL1521075P19T09F-03 LAYOUT: F16 PATH: U:\P50\Projects\Clients\1521-KingCo\554-1521-075-ELST\955vcs\CAAD\Phase 19\Task 09\SEG B PLOTTED BY: purgobut DATE: Friday, July 07, 2017 12:35:33 PM

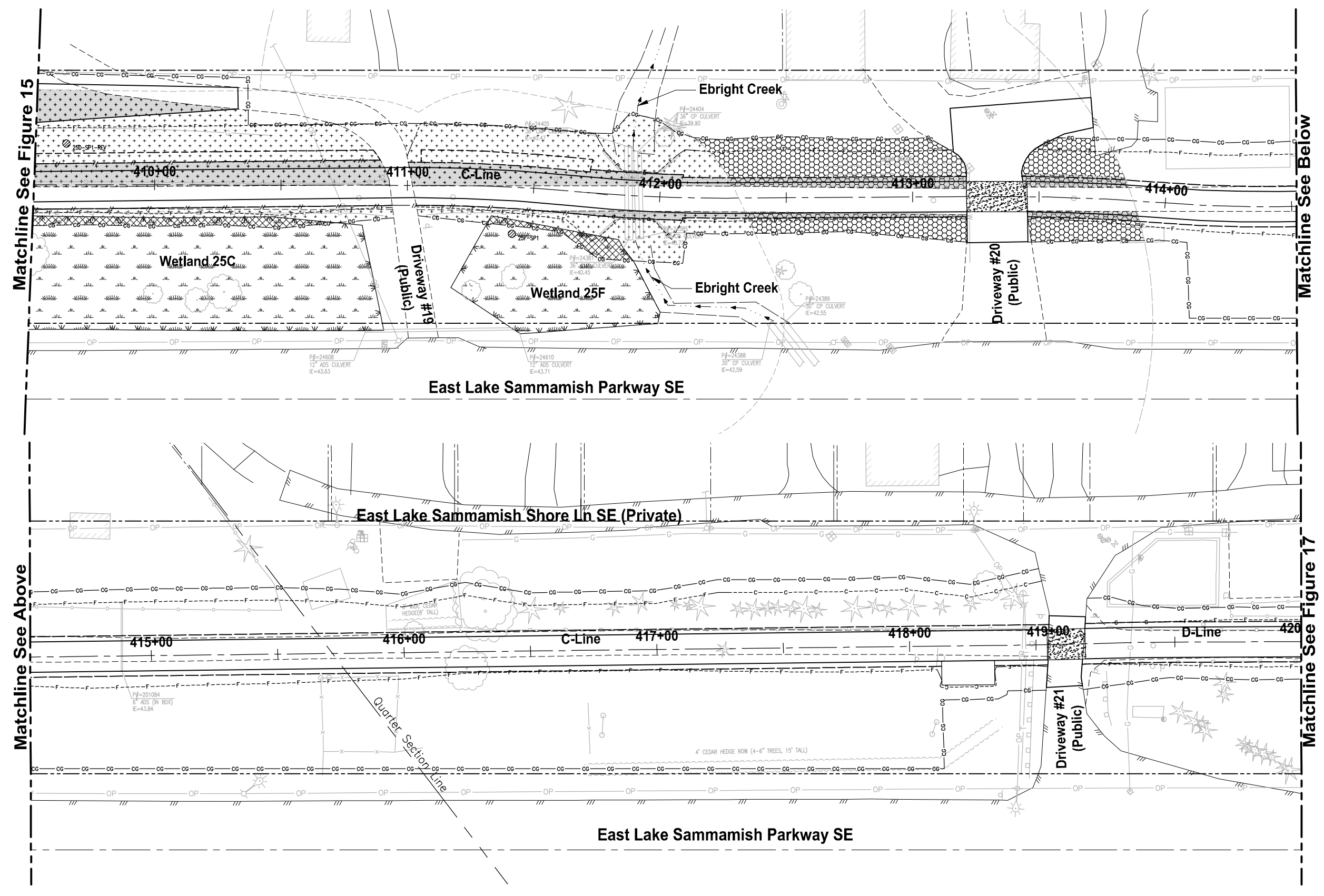

Parametrix DATE: July 7, 2017 FILE: BL1521075P19T09F-03

**Legend:**

- |          |                   |       |                           |           |                             |           |                                |
|----------|-------------------|-------|---------------------------|-----------|-----------------------------|-----------|--------------------------------|
| 10C-SP2  | Data Plot         | ----- | 50-Foot Shoreline Setback | [Pattern] | Perm. Wetland Impact        | [Pattern] | Perm. Stream Buffer Impact     |
| [Symbol] | Wetland Boundary  | ----- | 200-Foot Shoreline Zone   | [Pattern] | Temp. Wetland Impact        | [Pattern] | Temp. Stream Buffer Impact     |
| [Symbol] | Wetland Buffer    | ----- | Right of Way              | [Pattern] | Perm. Wetland Buffer Impact | [Pattern] | Temp. Shoreline Setback Impact |
| [Symbol] | Stream Buffer     | ----- | Retaining Walls           | [Pattern] | Temp. Wetland Buffer Impact | [Pattern] | Perm. Shoreline Setback Impact |
| [Symbol] | Stream OHWM       | ----- | Fill Limit                | [Pattern] |                             | [Pattern] | Temp. Stream Impact            |
| [Symbol] | Stream Centerline | ----- | Cut Limit                 | [Pattern] |                             |           |                                |
| [Symbol] | Ditch             | ----- | Clearing/Grubbing Limit   |           |                             |           |                                |
| [Symbol] | Lake OHWM         |       |                           |           |                             |           |                                |



**Figure 16**  
Critical Area Impacts  
East Lake Sammamish Trail  
South Sammamish Segment B

Exhibit 16  
SSD-2016-00413  
09/13/16

FILE: BL1521075P19T09F-04 LAYOUT: F17 PATH: U:\PSO\Projects\Clients\1521-KingCo\554-1521-075-ELST\955vcs\CAAD\Phase 19\Task 09\SEG B PLOTTED BY: purgobut DATE: Friday, July 07, 2017 12:36:52 PM

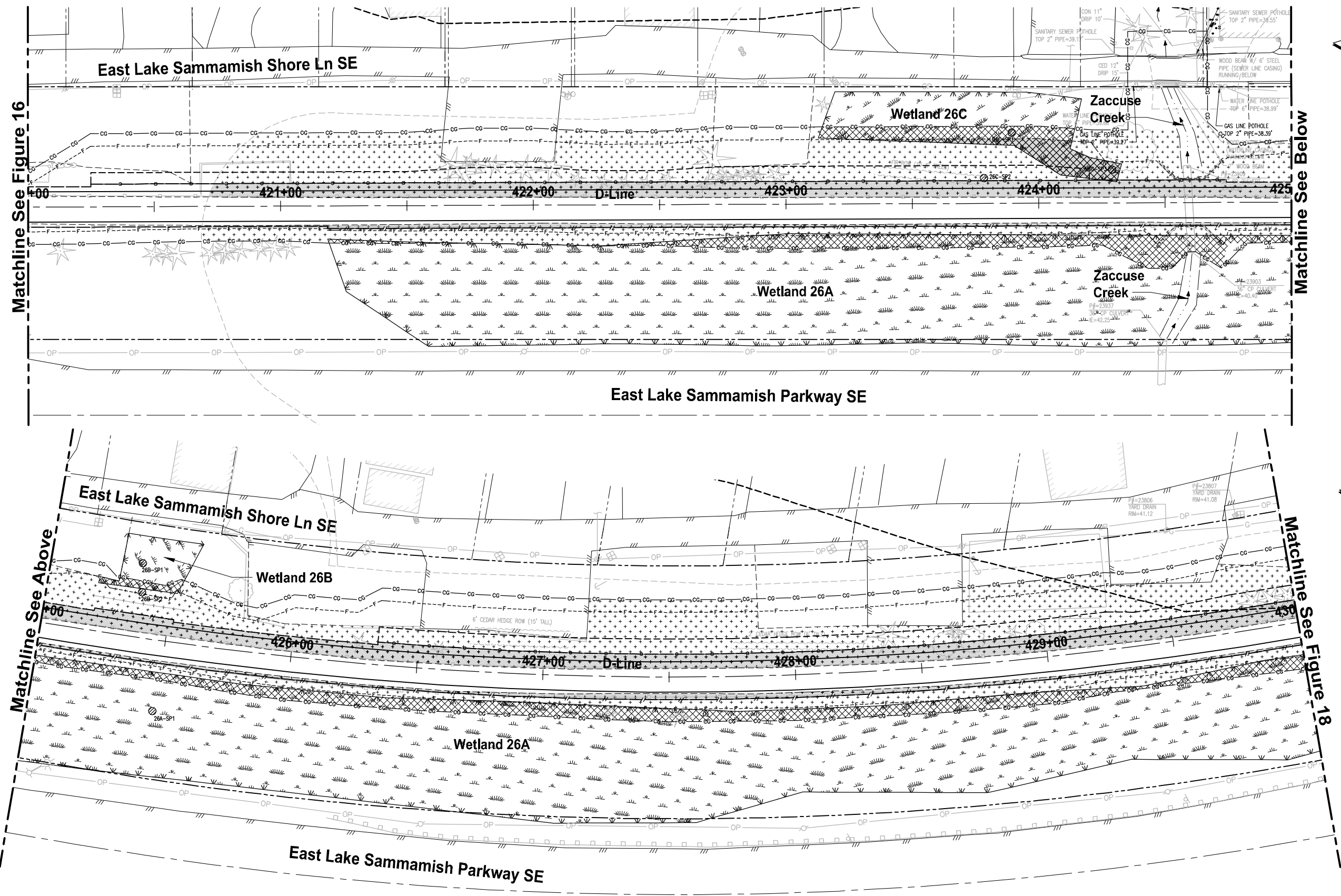

Matchline See Figure 16

Matchline See Below

Matchline See Above

Matchline See Figure 18

Parametrix DATE: July 7, 2017 FILE: BL1521075P19T09F-04

**Legend:**

- |                            |                   |       |                           |                                |                             |                   |                                |
|----------------------------|-------------------|-------|---------------------------|--------------------------------|-----------------------------|-------------------|--------------------------------|
| 10C-SP2                    | Data Plot         | ----- | 50-Foot Shoreline Setback | [Cross-hatch pattern]          | Perm. Wetland Impact        | [Hexagon pattern] | Perm. Stream Buffer Impact     |
| [Wetland boundary symbol]  | Wetland Boundary  | ----- | 200-Foot Shoreline Zone   | [Diagonal cross-hatch pattern] | Temp. Wetland Impact        | [Hexagon pattern] | Temp. Stream Buffer Impact     |
| [Wetland buffer symbol]    | Wetland Buffer    | ----- | Right of Way              | [Dotted pattern]               | Perm. Wetland Buffer Impact | [Diagonal lines]  | Temp. Shoreline Setback Impact |
| [Stream buffer symbol]     | Stream Buffer     | ----- | Retaining Walls           | [Dotted pattern]               | Temp. Wetland Buffer Impact | [Diagonal lines]  | Perm. Shoreline Setback Impact |
| [Stream OHWM symbol]       | Stream OHWM       | ----- | Fill Limit                | [Dotted pattern]               |                             | [Diagonal lines]  | Temp. Stream Impact            |
| [Stream centerline symbol] | Stream Centerline | ----- | Cut Limit                 |                                |                             |                   |                                |
| [Ditch symbol]             | Ditch             | ----- | Clearing/Grubbing Limit   |                                |                             |                   |                                |
| [Lake OHWM symbol]         | Lake OHWM         |       |                           |                                |                             |                   |                                |



**Figure 17**  
**Critical Area Impacts**  
 East Lake Sammamish Trail  
 South Sammamish Segment B

Exhibit 16  
 SSDP-2016-00415  
 091341

FILE: BL1521075P19T09F-04 LAYOUT: F18 PATH: U:\P50\Projects\Clients\1521-KingCo\554-1521-075-ELST\955v3\CAAD\Phase 19\Task 09\_SEG B PLOTTED BY: purgobut DATE: Friday, July 07, 2017 12:37:23 PM

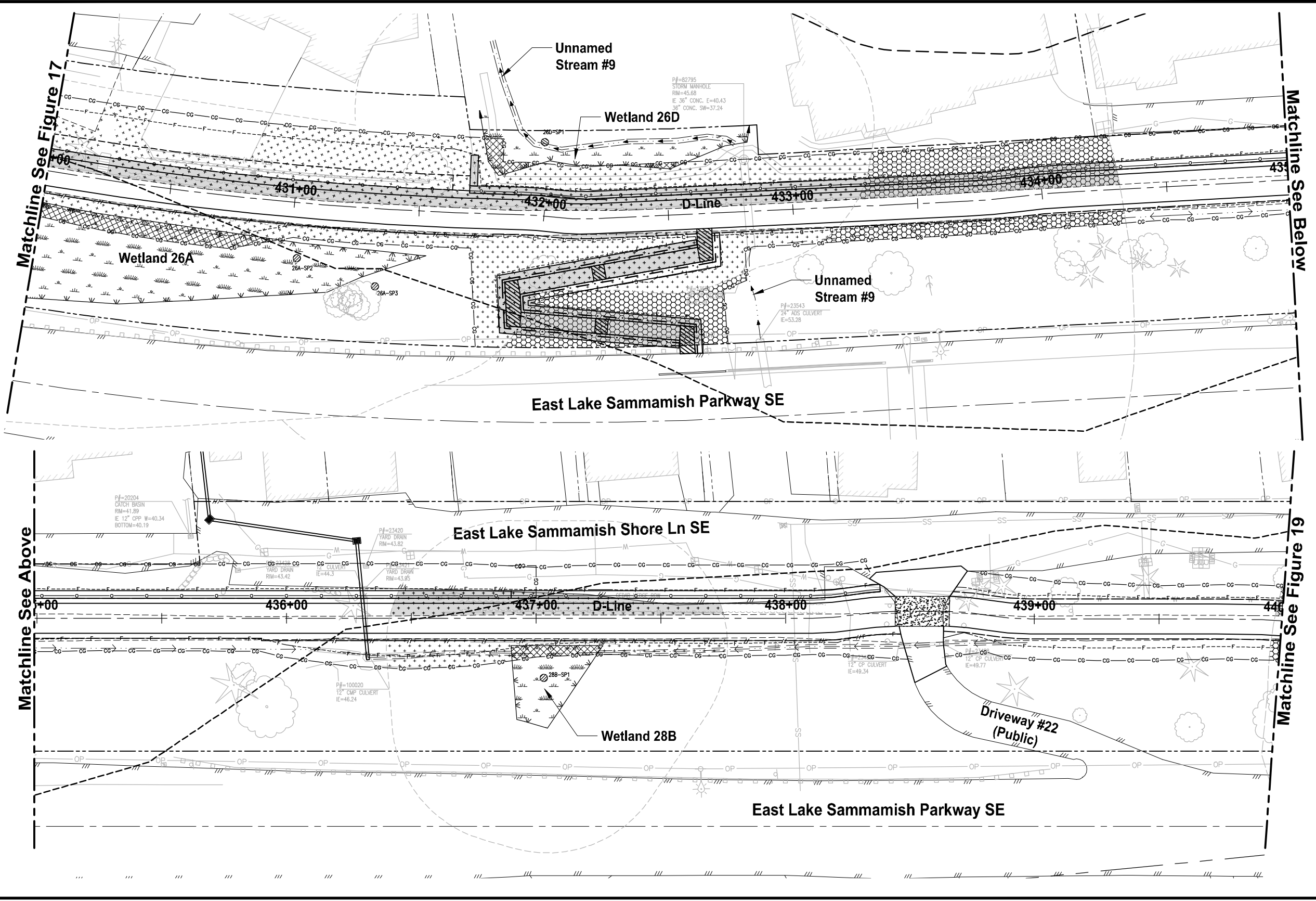

Matchline See Figure 17

Matchline See Below

Matchline See Above

Matchline See Figure 19

Parametrix DATE: July 7, 2017 FILE: BL1521075P19T09F-04

**Legend:**

- |         |                   |       |                           |                                |                             |                                |                                |
|---------|-------------------|-------|---------------------------|--------------------------------|-----------------------------|--------------------------------|--------------------------------|
| 10C-SP2 | Data Plot         | ----- | 50-Foot Shoreline Setback | [Cross-hatch pattern]          | Perm. Wetland Impact        | [Hexagon pattern]              | Perm. Stream Buffer Impact     |
| --- --- | Wetland Boundary  | ----- | 200-Foot Shoreline Zone   | [Diagonal cross-hatch pattern] | Temp. Wetland Impact        | [Hexagon pattern]              | Temp. Stream Buffer Impact     |
| --- --- | Wetland Buffer    | ----- | Right of Way              | [Dotted pattern]               | Perm. Wetland Buffer Impact | [Diagonal cross-hatch pattern] | Temp. Shoreline Setback Impact |
| --- --- | Stream Buffer     | ----- | Retaining Walls           | [Dotted pattern]               | Temp. Wetland Buffer Impact | [Diagonal cross-hatch pattern] | Perm. Shoreline Setback Impact |
| --- --- | Stream OHWM       | ----- | Fill Limit                | ---                            | ---                         | ---                            | ---                            |
| --- --- | Stream Centerline | ----- | Cut Limit                 | ---                            | ---                         | ---                            | ---                            |
| --- --- | Ditch             | ----- | Clearing/Grubbing Limit   | ---                            | ---                         | ---                            | ---                            |
| --- --- | Lake OHWM         | ----- |                           |                                |                             |                                |                                |



**Figure 18**  
**Critical Area Impacts**  
 East Lake Sammamish Trail  
 South Sammamish Segment B

Exhibit 16  
 SSDP 2016-00413  
 091342

FILE: BL1521075P19T09F-04 LAYOUT: F19 PATH: U:\P50\Projects\Clients\1521-KingCo\554-1521-075-ELST\955vcs\CAAD\Phase 19\Task 09\_SEG B PLOTTED BY: purgobut DATE: Friday, July 07, 2017 12:37:52 PM

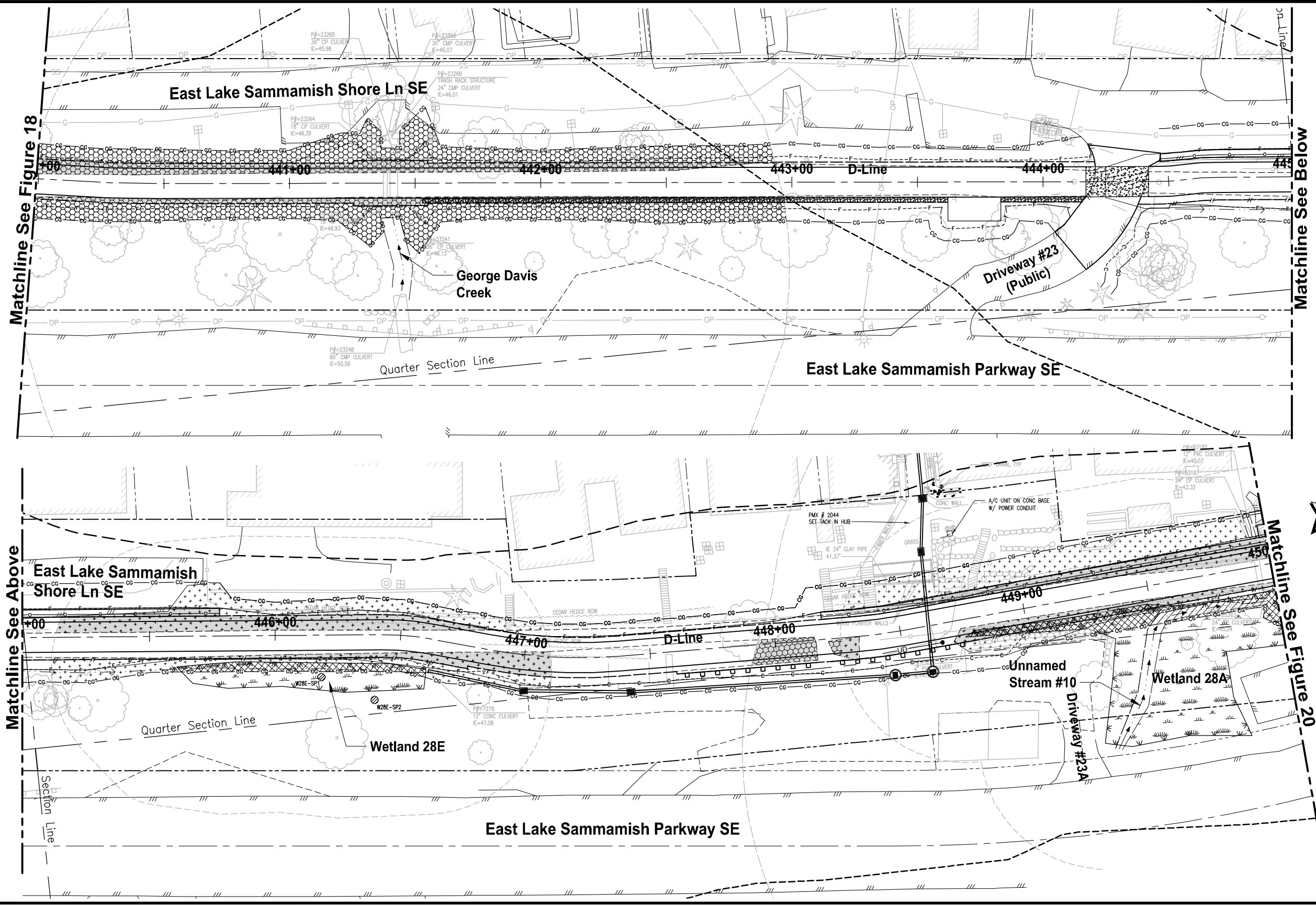

Matchline See Below

Matchline See Figure 20



Parametrix DATE: July 7, 2017 FILE: BL1521075P19T09F-04

**Legend:**

- |         |                   |         |                           |                                |                             |                                |                                |
|---------|-------------------|---------|---------------------------|--------------------------------|-----------------------------|--------------------------------|--------------------------------|
| 10C-SP2 | Data Plot         | --- --- | 50-Foot Shoreline Setback | [Cross-hatch pattern]          | Perm. Wetland Impact        | [Circular pattern]             | Perm. Stream Buffer Impact     |
| --- --- | Wetland Boundary  | --- --- | 200-Foot Shoreline Zone   | [Diagonal cross-hatch pattern] | Temp. Wetland Impact        | [Circular pattern]             | Temp. Stream Buffer Impact     |
| --- --- | Wetland Buffer    | --- --- | Right of Way              | [Dotted pattern]               | Perm. Wetland Buffer Impact | [Diagonal cross-hatch pattern] | Temp. Shoreline Setback Impact |
| --- --- | Stream Buffer     | --- --- | Retaining Walls           | [Dotted pattern]               | Temp. Wetland Buffer Impact | [Diagonal cross-hatch pattern] | Perm. Shoreline Setback Impact |
| --- --- | Stream OHWM       | --- --- | Fill Limit                | ---                            | ---                         | ---                            | ---                            |
| --- --- | Stream Centerline | ---     | Cut Limit                 | ---                            | ---                         | ---                            | ---                            |
| --- --- | Ditch             | ---     | Clearing/Grubbing Limit   | ---                            | ---                         | ---                            | ---                            |
| --- --- | Lake OHWM         | ---     | ---                       | ---                            | ---                         | ---                            | ---                            |



**Figure 19**  
**Critical Area Impacts**  
 East Lake Sammamish Trail  
 South Sammamish Segment B

Exhibit 16  
 SSDP-2016-00413  
 09/13/17

FILE: BL1521075P19T09F-04 LAYOUT: F20 PATH: U:\PSO\Projects\Clients\1521-075-ELST\955xcs\CADD\Phase 19\Task 09\SEG B PLOTTED BY: purgubut DATE: Friday, July 07, 2017 12:38:18 PM

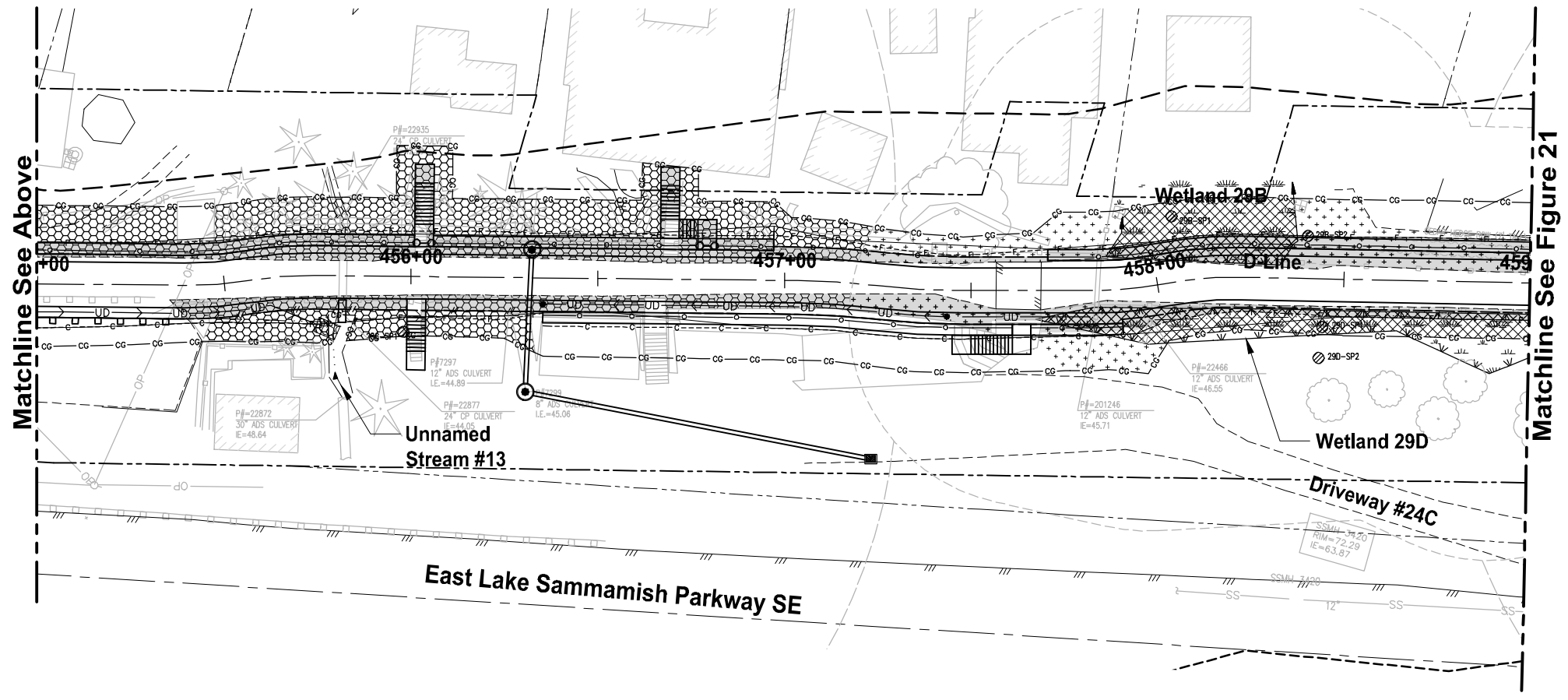
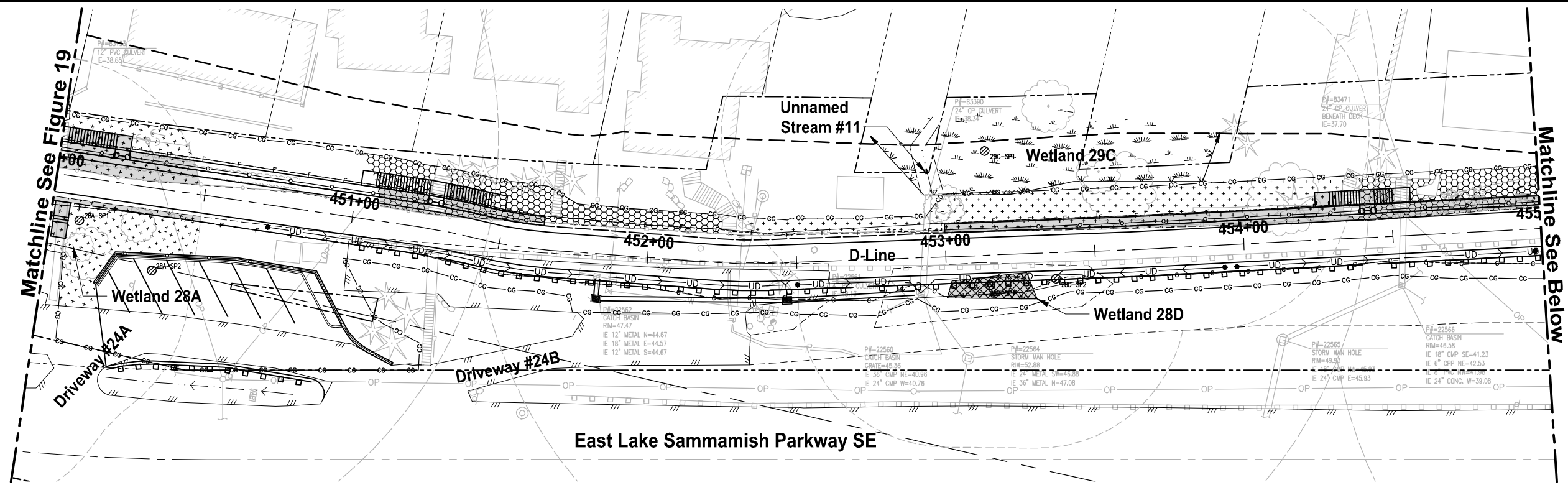

Parametrix DATE: July 7, 2017 FILE: BL1521075P19T09F-04

**Legend:**

- |               |                   |              |                           |                  |                             |                  |                                |
|---------------|-------------------|--------------|---------------------------|------------------|-----------------------------|------------------|--------------------------------|
| 10C-SP2       | Data Plot         | ---          | 50-Foot Shoreline Setback | [Cross-hatch]    | Perm. Wetland Impact        | [Stippled]       | Perm. Stream Buffer Impact     |
| [Wavy line]   | Wetland Boundary  | ---          | 200-Foot Shoreline Zone   | [Diagonal lines] | Temp. Wetland Impact        | [Stippled]       | Temp. Stream Buffer Impact     |
| [Dashed line] | Wetland Buffer    | ---          | Right of Way              | [Dotted]         | Perm. Wetland Buffer Impact | [Diagonal lines] | Temp. Shoreline Setback Impact |
| [Dashed line] | Stream Buffer     | [Solid line] | Retaining Walls           | [Dotted]         | Temp. Wetland Buffer Impact | [Diagonal lines] | Perm. Shoreline Setback Impact |
| [Dashed line] | Stream OHWM       | ---          | Fill Limit                | [Dotted]         | Temp. Wetland Buffer Impact | [Diagonal lines] | Temp. Stream Impact            |
| [Dashed line] | Stream Centerline | ---          | Cut Limit                 | [Dotted]         |                             |                  |                                |
| [Dashed line] | Ditch             | ---          | Clearing/Grubbing Limit   |                  |                             |                  |                                |
| [Dashed line] | Lake OHWM         |              |                           |                  |                             |                  |                                |



**Figure 20**  
**Critical Area Impacts**  
 East Lake Sammamish Trail  
 South Sammamish Segment B

Exhibit 16  
 SSDP-2016-00413  
 09/13/14

FILE: BL1521075P19T09F-04 LAYOUT: F21 PATH: U:\PSO\Projects\Clients\1521-KingCo\554-1521-075-ELST\955vcs\CAAD\Phase 19\Task 09\SEG B PLOTTED BY: purgobut DATE: Friday, July 07, 2017 12:38:48 PM

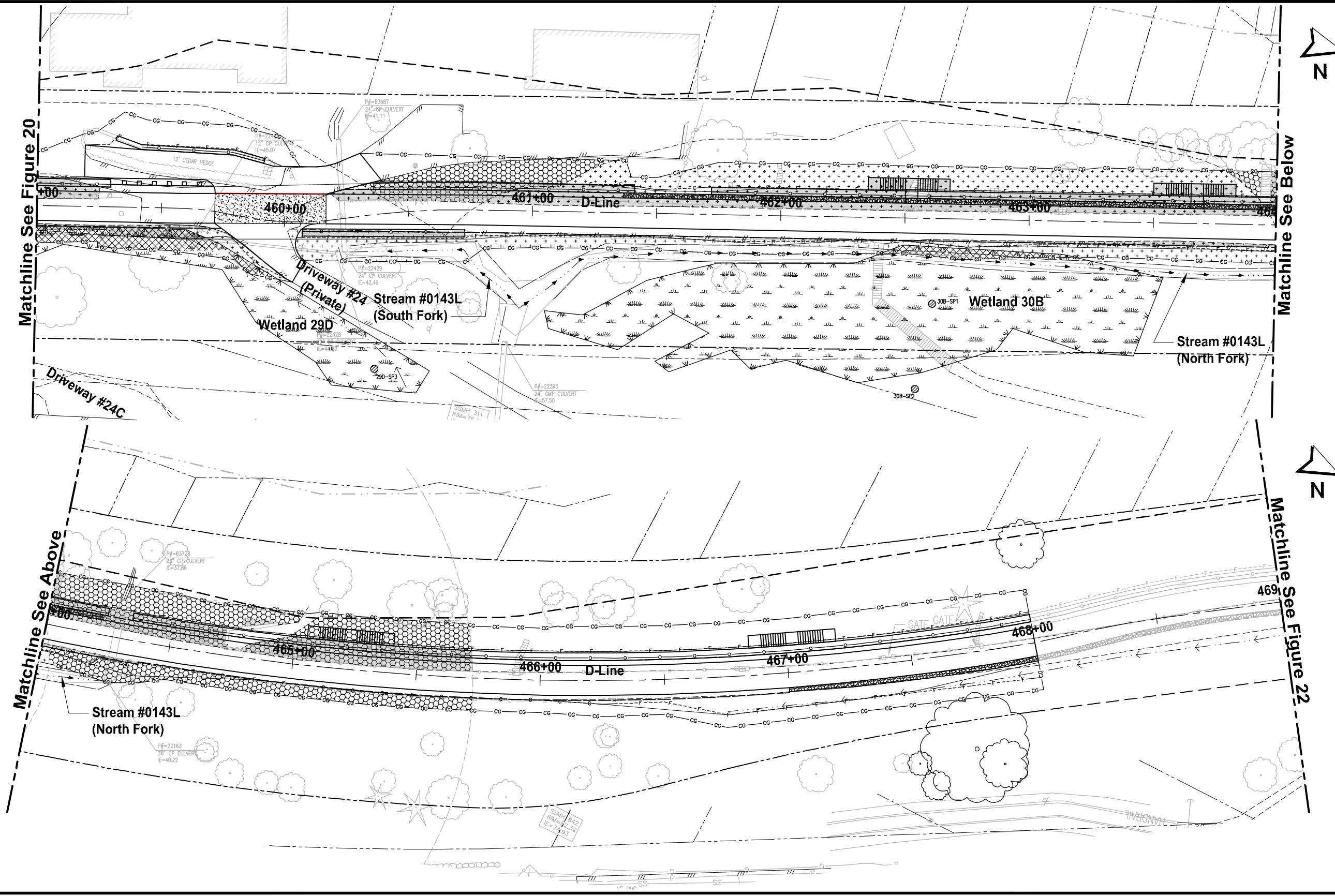

Parametrix DATE: July 7, 2017 FILE: BL1521075P19T09F-04

**Legend:**

- |         |                   |       |                           |                                |                             |                                |                                |
|---------|-------------------|-------|---------------------------|--------------------------------|-----------------------------|--------------------------------|--------------------------------|
| 10C-SP2 | Data Plot         | ----- | 50-Foot Shoreline Setback | [Cross-hatch pattern]          | Perm. Wetland Impact        | [Circular pattern]             | Perm. Stream Buffer Impact     |
| --- --- | Wetland Boundary  | ----- | 200-Foot Shoreline Zone   | [Diagonal cross-hatch pattern] | Temp. Wetland Impact        | [Circular pattern]             | Temp. Stream Buffer Impact     |
| --- --- | Wetland Buffer    | ----- | Right of Way              | [Dotted pattern]               | Perm. Wetland Buffer Impact | [Diagonal cross-hatch pattern] | Temp. Shoreline Setback Impact |
| --- --- | Stream Buffer     | ----- | Retaining Walls           | [Dotted pattern]               | Temp. Wetland Buffer Impact | [Diagonal cross-hatch pattern] | Perm. Shoreline Setback Impact |
| --- --- | Stream OHWM       | ----- | Fill Limit                | -----                          | -----                       | -----                          | -----                          |
| --- --- | Stream Centerline | ----- | Cut Limit                 | -----                          | -----                       | -----                          | -----                          |
| --- --- | Ditch             | ----- | Clearing/Grubbing Limit   | -----                          | -----                       | -----                          | -----                          |
| --- --- | Lake OHWM         | ----- |                           |                                |                             |                                |                                |



**Figure 21**  
**Critical Area Impacts**  
 East Lake Sammamish Trail  
 South Sammamish Segment B

Exhibit 16  
 SSDP 2016-00413  
 09/13/15

FILE: BL1521075P19T09F-04 LAYOUT: F22 PATH: U:\PSO\Projects\Clients\1521-KingCo\554-1521-075-ELST\955x3\CADD\Phase 19\Task 09\SEG B PLOTTED BY: purgabub DATE: Friday, July 07, 2017 12:38:07 PM

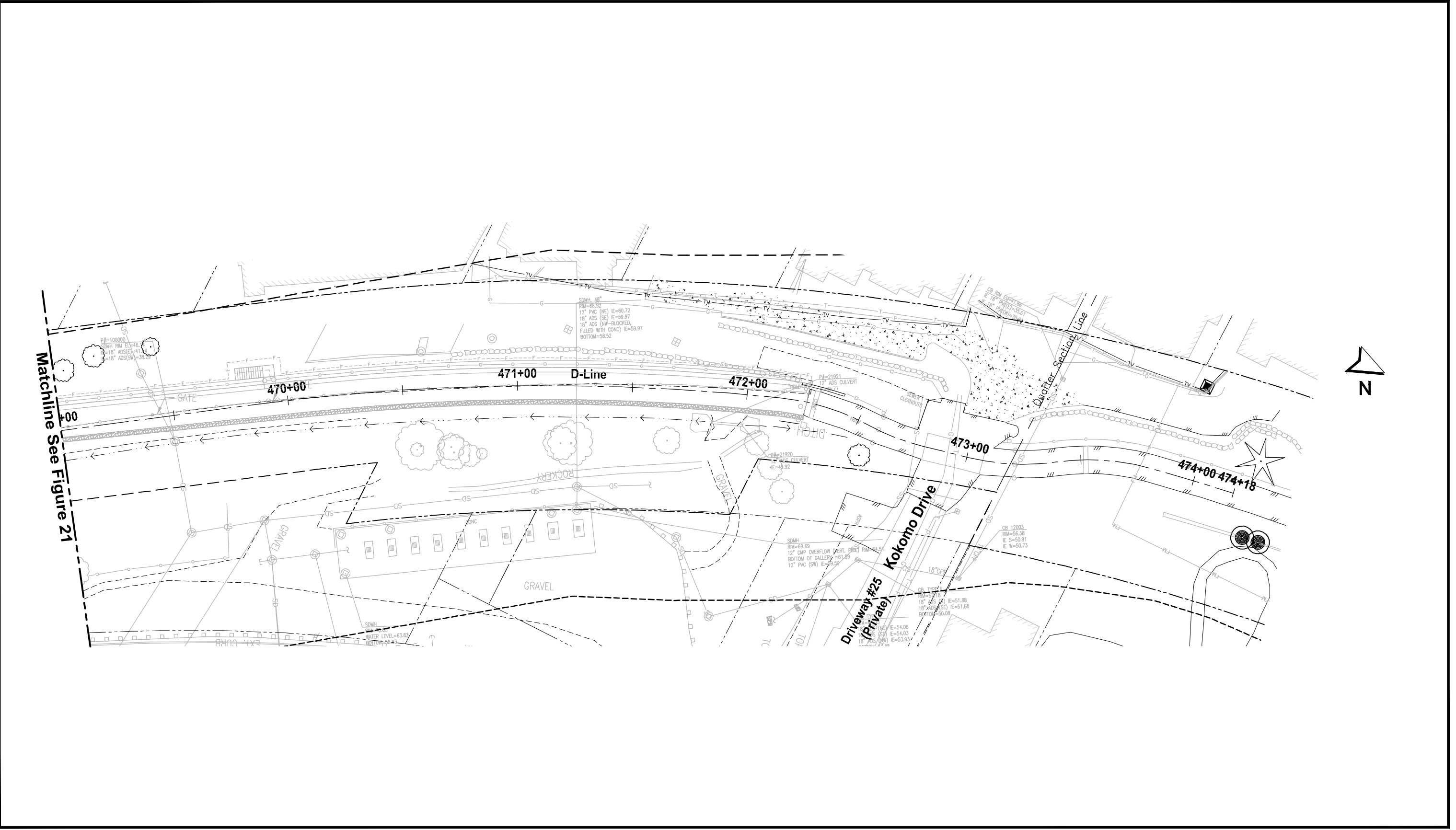

Parametrix DATE: July 7, 2017 FILE: BL1521075P19T09F-04

**Legend:**

- |                  |                   |       |                           |                        |                             |                     |                                |
|------------------|-------------------|-------|---------------------------|------------------------|-----------------------------|---------------------|--------------------------------|
| 10C-SP2          | Data Plot         | ----- | 50-Foot Shoreline Setback | [Cross-hatch pattern]  | Perm. Wetland Impact        | [Circular pattern]  | Perm. Stream Buffer Impact     |
| [Wetland symbol] | Wetland Boundary  | ----- | 200-Foot Shoreline Zone   | [Diagonal cross-hatch] | Temp. Wetland Impact        | [Circular pattern]  | Temp. Stream Buffer Impact     |
| [Dashed line]    | Wetland Buffer    | ----- | Right of Way              | [Dotted pattern]       | Perm. Wetland Buffer Impact | [Diagonal hatching] | Temp. Shoreline Setback Impact |
| [Dashed line]    | Stream Buffer     | ----- | Retaining Walls           | [Star pattern]         | Temp. Wetland Buffer Impact | [Diagonal hatching] | Perm. Shoreline Setback Impact |
| [Dashed line]    | Stream OHWM       | ----- | Fill Limit                | [Star pattern]         | -----                       | [Diagonal hatching] | Temp. Stream Impact            |
| [Dashed line]    | Stream Centerline | ----- | Cut Limit                 | CG CG                  | -----                       | [Diagonal hatching] |                                |
| [Dashed line]    | Ditch             | ----- | Clearing/Grubbing Limit   |                        |                             |                     |                                |
| [Dashed line]    | Lake OHWM         |       |                           |                        |                             |                     |                                |



**Figure 22**  
**Critical Area Impacts**  
 East Lake Sammamish Trail  
 South Sammamish Segment B

Exhibit 16  
 SSDP-2016-00413  
 091346

# APPENDIX E

## Critical Areas Mitigation Landscape Plans



PATH: U:\PSO\Projects\Clients\1521-075-ELST\98\SS\CA\Phase 19\T03\_C\LA1(Dwg) PLOTTED BY: purgubut DATE: Friday, July 07, 2017 3:05:53 PM LAYOUT: LA1

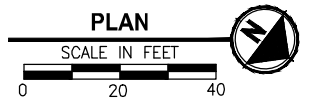
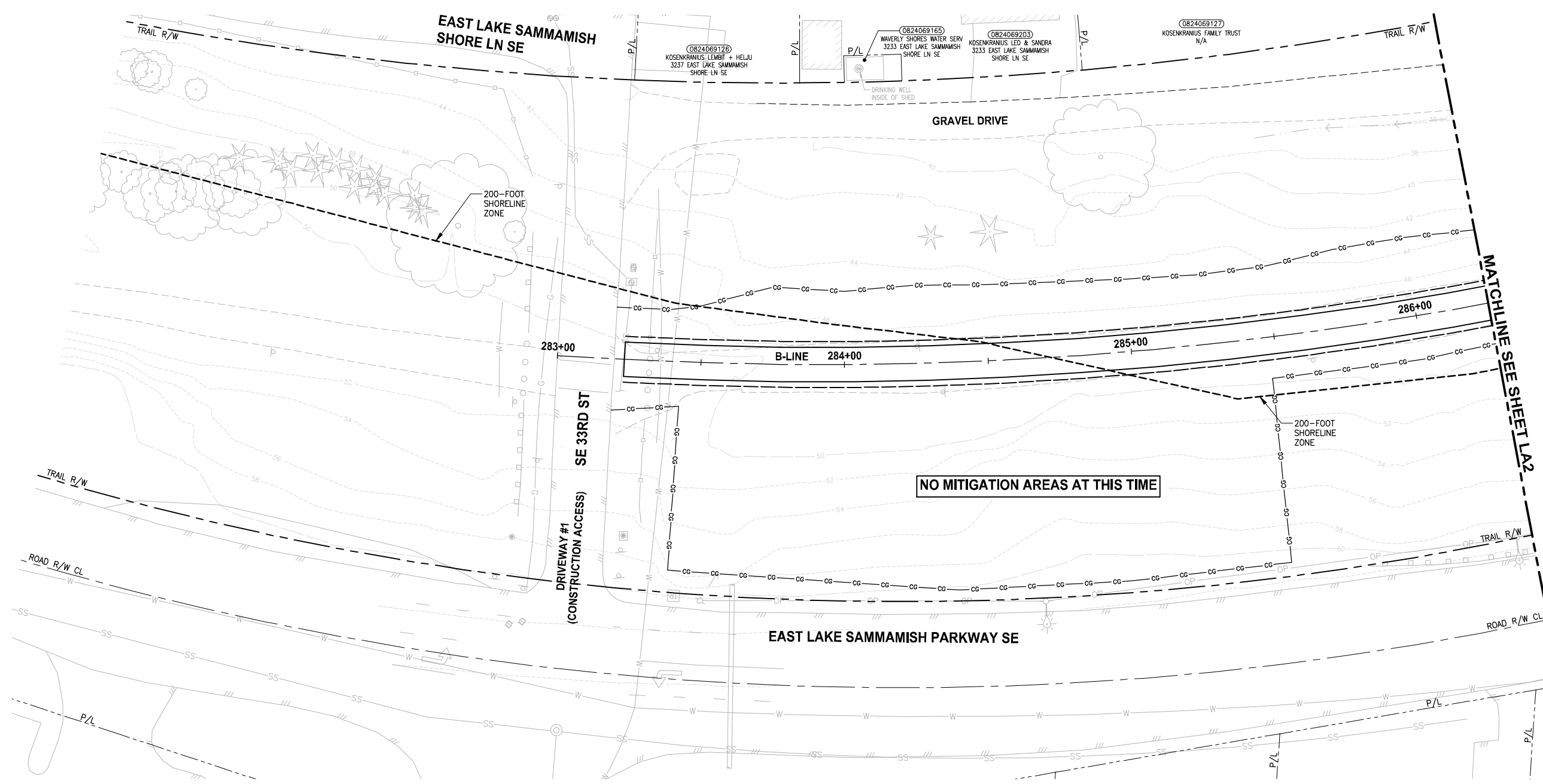

- CONSTRUCTION NOTES:**
- 1 REMOVE LAWN IN THIS AREA.
  - 2 REMOVE CONCRETE PAD.
  - 3 REMOVE GRAVEL PAVING.
  - 4 REMOVE STRUCTURE IN THIS AREA.
  - 5 PROTECT EXISTING NATIVE TREES AND SHRUBS; REMOVE BLACKBERRY AND OTHER UNWANTED INVASIVE PLANTS; AMEND SOIL WITH COMPOST; PLANT WITH NATIVE WETLAND PLANTS AND PLACE WOOD CHIP MULCH OVER ENTIRE AREA.
  - 6 PROTECT EXISTING NATIVE TREES AND SHRUBS; REMOVE BLACKBERRY AND OTHER UNWANTED INVASIVE PLANTS; AMEND SOIL WITH COMPOST; PLANT WITH NATIVE BUFFER PLANTS AND PLACE WOOD CHIP MULCH OVER ENTIRE AREA.
  - 7 GRADE AREA TO CREATE WETLAND CONDITIONS AND AMEND SOIL WITH COMPOST, PLANT WITH NATIVE WETLAND PLANTS.

- GENERAL NOTES:**
1. SEE SHEET LA23 FOR DETAILS AND PLANT LISTS.
  2. SEEDING FOR REMOVED DRIVEWAYS IS NOT PART OF THE MITIGATION PLAN.

- LEGEND:**
- WBE WETLAND BUFFER ENHANCEMENT (6)
  - WBA WETLAND BUFFER ADDITION AREA (6)
  - SSE SHORELINE SETBACK ENHANCEMENT AREA (6)
  - WC/WR WETLAND CREATION OR RESTORATION AREA (7)
  - WE WETLAND ENHANCEMENT AREA (5)
  - SBE STREAM BUFFER ENHANCEMENT AREA (6)
  - SEEDING FOR REMOVED DRIVEWAYS. NOTE 2.

CITY OF SAMMAMISH APPROVAL	
City Engineer _____	Date _____
Community Development _____	Date _____

**REVISED 60% REVIEW SUBMITTAL  
NOT FOR CONSTRUCTION**

REVISIONS	DATE	BY	DESIGNED
			J. SWENSON
			B. PURGANAN
			P. JOHANNESSEN
			Y. HO

**ONE INCH AT FULL SCALE, IF NOT, SCALE ACCORDINGLY**  
 FILE NAME: BL1521075P19T03LA-01  
 JOB No.: 54-1521-075 P19 T03  
 DATE: JULY 2017

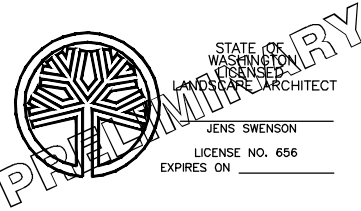

**Parametrix**  
 ENGINEERING · PLANNING · ENVIRONMENTAL SCIENCES  
 719 2ND AVENUE, SUITE 200 | SEATTLE, WA 98104  
 P 206.394.3700  
 WWW.PARAMETRIX.COM

PROJECT NAME  
**EAST LAKE SAMMAMISH  
 MASTER PLAN TRAIL  
 SOUTH SAMMAMISH SEGMENT B**  
 SAMMAMISH, WA

**Exhibit 16  
 SSDP2016-00415  
 LANDSCAPE PLAN 001348**

SHEET NO.  
 135 OF 158  
**LA1**

PATH: U:\P50\Projects\Clients\1521-075-ELST\985Secs\CADD\Phase 19\T03\_Civil\Draw\ LAYOUT: LA2 PLOTTED BY: purgahan DATE: Friday, July 07, 2017 3:06:10 PM

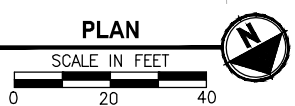
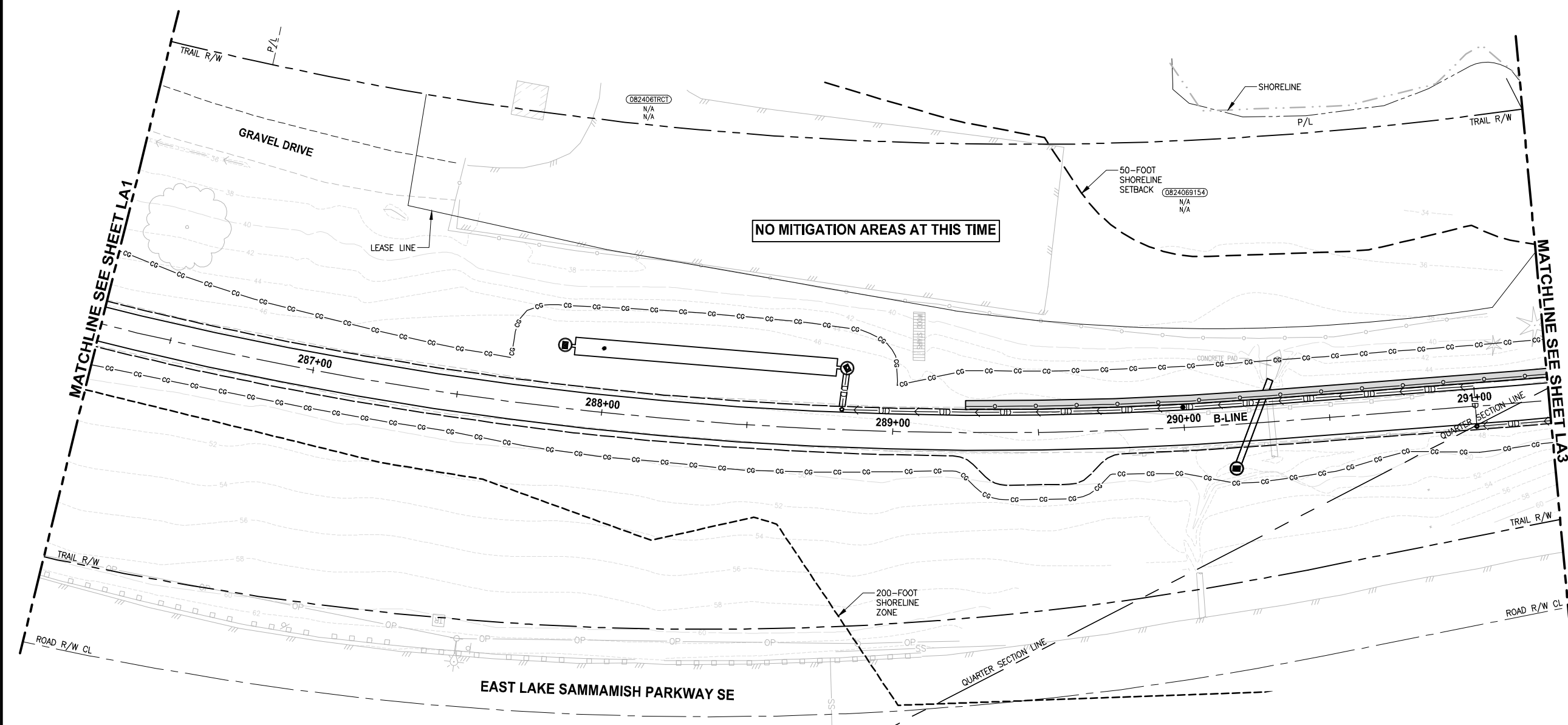

- CONSTRUCTION NOTES:**
- 1 REMOVE LAWN IN THIS AREA.
  - 2 REMOVE CONCRETE PAD.
  - 3 REMOVE GRAVEL PAVING.
  - 4 REMOVE STRUCTURE IN THIS AREA.
  - 5 PROTECT EXISTING NATIVE TREES AND SHRUBS; REMOVE BLACKBERRY AND OTHER UNWANTED INVASIVE PLANTS; AMEND SOIL WITH COMPOST; PLANT WITH NATIVE WETLAND PLANTS AND PLACE WOOD CHIP MULCH OVER ENTIRE AREA.
  - 6 PROTECT EXISTING NATIVE TREES AND SHRUBS; REMOVE BLACKBERRY AND OTHER UNWANTED INVASIVE PLANTS; AMEND SOIL WITH COMPOST; PLANT WITH NATIVE BUFFER PLANTS AND PLACE WOOD CHIP MULCH OVER ENTIRE AREA.
  - 7 GRADE AREA TO CREATE WETLAND CONDITIONS AND AMEND SOIL WITH COMPOST, PLANT WITH NATIVE WETLAND PLANTS.

- GENERAL NOTES:**
1. SEE SHEET LA23 FOR DETAILS AND PLANT LISTS.
  2. SEEDING FOR REMOVED DRIVEWAYS IS NOT PART OF THE MITIGATION PLAN.

- LEGEND:**
- WBE WETLAND BUFFER ENHANCEMENT (6)
  - WBA WETLAND BUFFER ADDITION AREA (6)
  - SSE SHORELINE SETBACK ENHANCEMENT AREA (6)
  - WC/WR WETLAND CREATION OR RESTORATION AREA (7)
  - WE WETLAND ENHANCEMENT AREA (5)
  - SBE STREAM BUFFER ENHANCEMENT AREA (6)
  - SEEDING FOR REMOVED DRIVEWAYS. NOTE 2.

CITY OF SAMMAMISH APPROVAL	
City Engineer _____	Date _____
Community Development _____	Date _____

**REVISED 60% REVIEW SUBMITTAL  
NOT FOR CONSTRUCTION**

**Exhibit 16  
SSDP2016-00415  
LANDSCAPE PLAN 001349**

SHEET NO.  
136 OF 158  
**LA2**

REVISIONS	DATE	BY	DESIGNED
			J. SWENSON
			B. PURGANAN
			P. JOHANNESSEN
			Y. HO

**ONE INCH AT FULL SCALE.  
IF NOT, SCALE ACCORDINGLY**

FILE NAME  
BL1521075P19T03LA-01

JOB No.  
554-1521-075 P19 T03

DATE  
JULY 2017

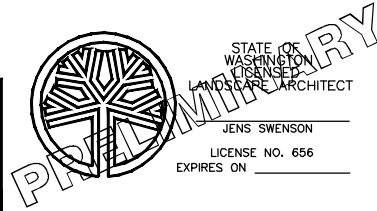

**Parametrix**  
ENGINEERING · PLANNING · ENVIRONMENTAL SCIENCES

719 2ND AVENUE, SUITE 200 | SEATTLE, WA 98104  
P 206.394.3700  
WWW.PARAMETRIX.COM

PROJECT NAME  
**EAST LAKE SAMMAMISH  
MASTER PLAN TRAIL  
SOUTH SAMMAMISH SEGMENT B**  
SAMMAMISH, WA

PATH: U:\P50\Projects\Clients\1521-075-ELST\95\Specs\CADD\Phase 19\T03\_CWA\DWG\ PLOTTED BY: purgaban DATE: Friday, July 07, 2017 3:06:37 PM LAYOUT: LA3

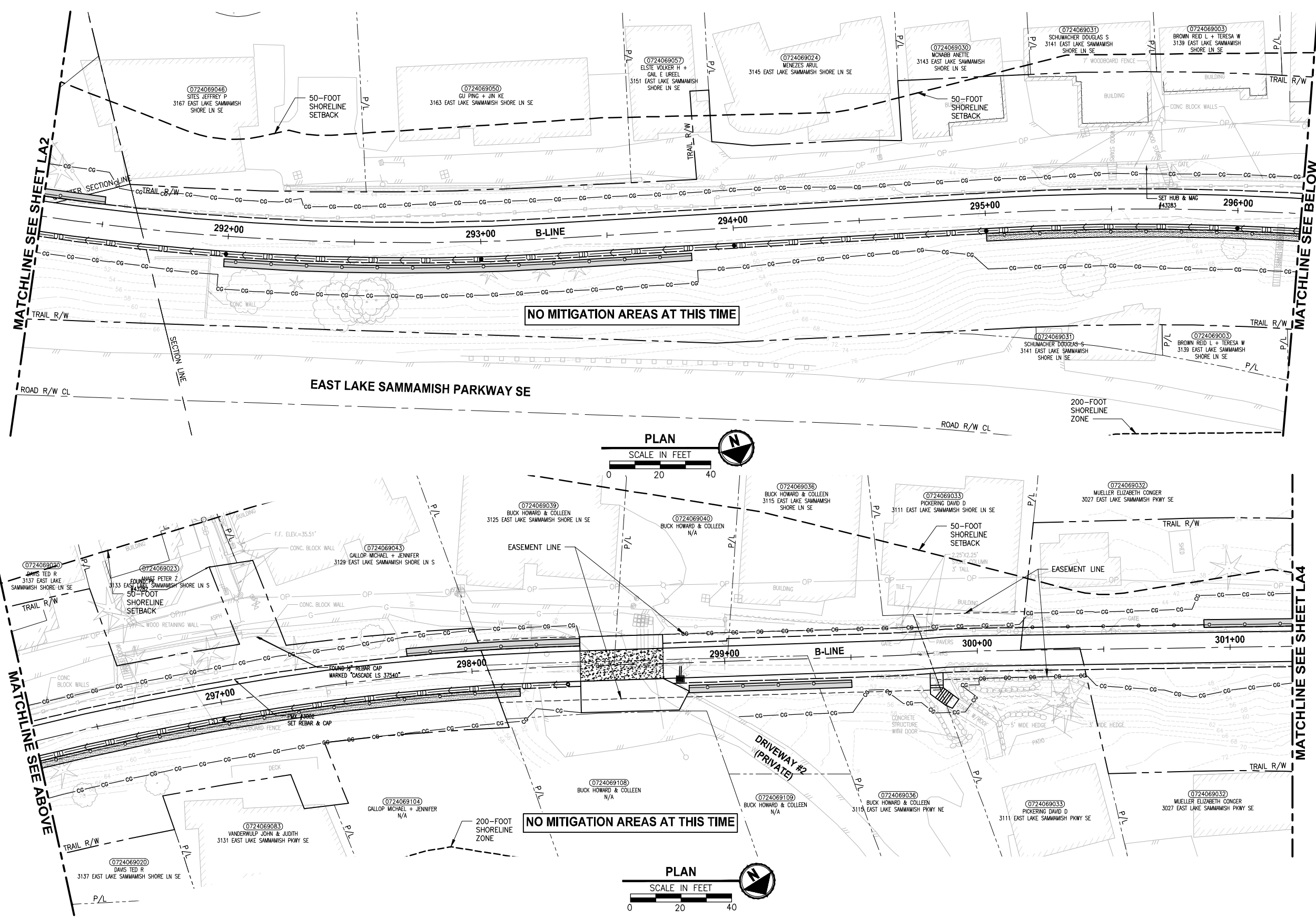

- CONSTRUCTION NOTES:**
- 1 REMOVE LAWN IN THIS AREA.
  - 2 REMOVE CONCRETE PAD.
  - 3 REMOVE GRAVEL PAVING.
  - 4 REMOVE STRUCTURE IN THIS AREA.
  - 5 PROTECT EXISTING NATIVE TREES AND SHRUBS; REMOVE BLACKBERRY AND OTHER UNWANTED INVASIVE PLANTS; AMEND SOIL WITH COMPOST; PLANT WITH NATIVE WETLAND PLANTS AND PLACE WOOD CHIP MULCH OVER ENTIRE AREA.
  - 6 PROTECT EXISTING NATIVE TREES AND SHRUBS; REMOVE BLACKBERRY AND OTHER UNWANTED INVASIVE PLANTS; AMEND SOIL WITH COMPOST; PLANT WITH NATIVE BUFFER PLANTS AND PLACE WOOD CHIP MULCH OVER ENTIRE AREA.
  - 7 GRADE AREA TO CREATE WETLAND CONDITIONS AND AMEND SOIL WITH COMPOST, PLANT WITH NATIVE WETLAND PLANTS.

- GENERAL NOTES:**
1. SEE SHEET LA23 FOR DETAILS AND PLANT LISTS.
  2. SEEDING FOR REMOVED DRIVEWAYS IS NOT PART OF THE MITIGATION PLAN.

- LEGEND:**
- WBE WETLAND BUFFER ENHANCEMENT (6)
  - WBA WETLAND BUFFER ADDITION AREA (6)
  - SSE SHORELINE SETBACK ENHANCEMENT AREA (6)
  - WC/WR WETLAND CREATION OR RESTORATION AREA (7)
  - WE WETLAND ENHANCEMENT AREA (5)
  - SBE STREAM BUFFER ENHANCEMENT AREA (6)
  - SEEDING FOR REMOVED DRIVEWAYS. NOTE 2.

CITY OF SAMMAMISH APPROVAL

City Engineer	Date
Community Development	Date

REVISED 60% REVIEW SUBMITTAL  
NOT FOR CONSTRUCTION

Exhibit 16  
SSDP2016-00415  
LANDSCAPE PLAN 001350  
LA3

REVISIONS	DATE	BY	DESIGNED
			J. SWENSON
			B. PURGANAN
			P. JOHANNESSEN
			Y. HO

ONE INCH AT FULL SCALE, IF NOT, SCALE ACCORDINGLY  
FILE NAME: BL1521075P19T03LA-01  
JOB No. 554-1521-075 P19 T03  
DATE: JULY 2017

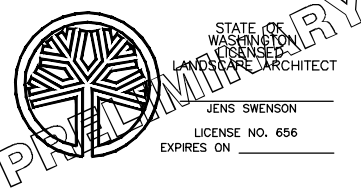

**Parametrix**  
ENGINEERING · PLANNING · ENVIRONMENTAL SCIENCES  
739 2ND AVENUE, SUITE 200 | SEATTLE, WA 98104  
P 206.394.3700  
WWW.PARAMETRIX.COM

PROJECT NAME  
**EAST LAKE SAMMAMISH  
MASTER PLAN TRAIL  
SOUTH SAMMAMISH SEGMENT B**  
SAMMAMISH, WA

SHEET NO.  
137 OF 158

PATH: U:\P50\Projects\Clients\1521-KingCo\554-1521-075-ELST\985Secs\CADD\Phase 19\T03\_Civil\Draw\ PLOTTED BY: purgubut DATE: Friday, July 07, 2017 3:07:01 PM LAYOUT: LA4

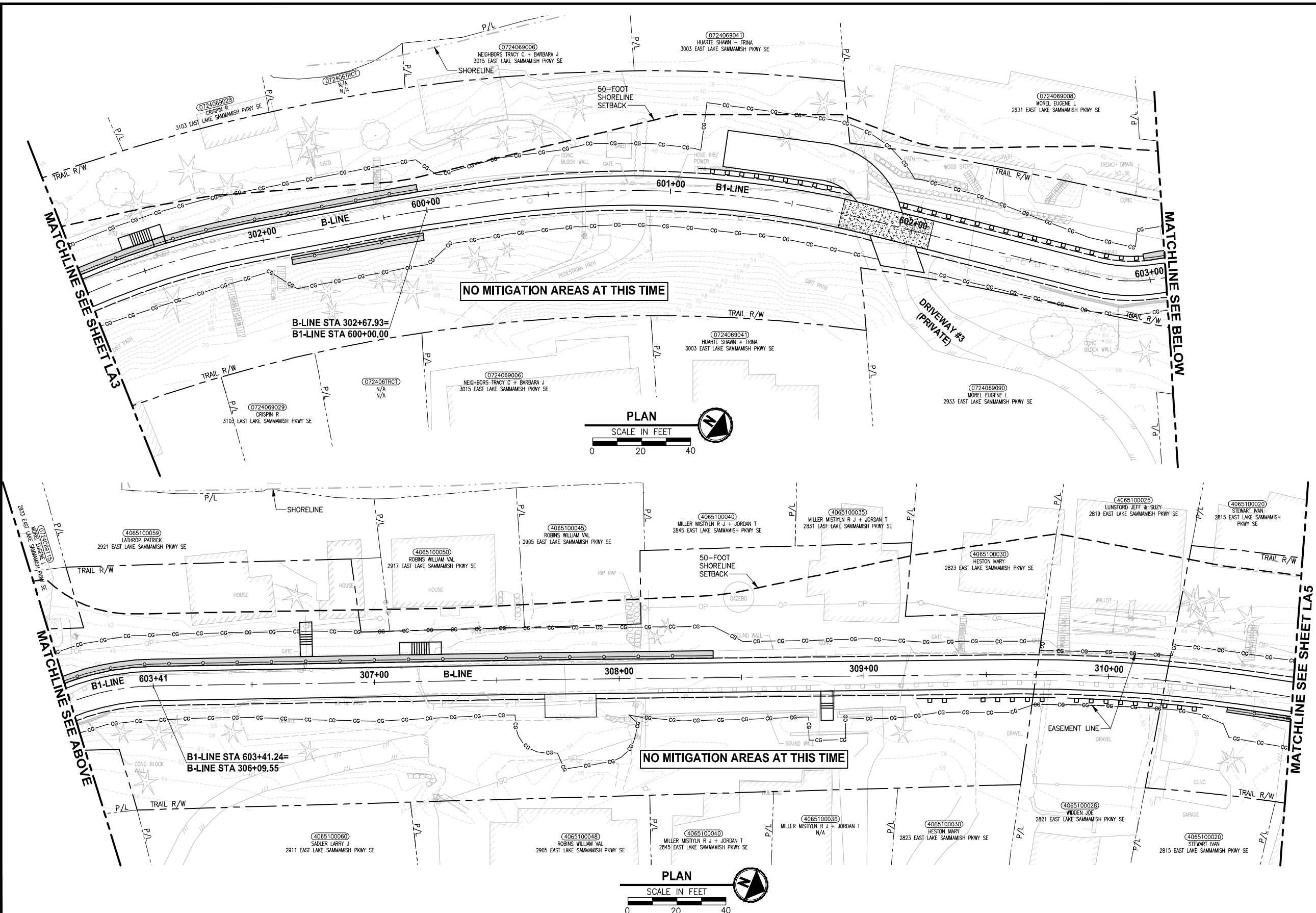

- CONSTRUCTION NOTES:**
- 1 REMOVE LAWN IN THIS AREA.
  - 2 REMOVE CONCRETE PAD.
  - 3 REMOVE GRAVEL PAVING.
  - 4 REMOVE STRUCTURE IN THIS AREA.
  - 5 PROTECT EXISTING NATIVE TREES AND SHRUBS; REMOVE BLACKBERRY AND OTHER UNWANTED INVASIVE PLANTS; AMEND SOIL WITH COMPOST; PLANT WITH NATIVE WETLAND PLANTS AND PLACE WOOD CHIP MULCH OVER ENTIRE AREA.
  - 6 PROTECT EXISTING NATIVE TREES AND SHRUBS; REMOVE BLACKBERRY AND OTHER UNWANTED INVASIVE PLANTS; AMEND SOIL WITH COMPOST; PLANT WITH NATIVE BUFFER PLANTS AND PLACE WOOD CHIP MULCH OVER ENTIRE AREA.
  - 7 GRADE AREA TO CREATE WETLAND CONDITIONS AND AMEND SOIL WITH COMPOST, PLANT WITH NATIVE WETLAND PLANTS.

- GENERAL NOTES:**
1. SEE SHEET LA23 FOR DETAILS AND PLANT LISTS.
  2. SEEDING FOR REMOVED DRIVEWAYS IS NOT PART OF THE MITIGATION PLAN.

**LEGEND:**

- WBE** WETLAND BUFFER ENHANCEMENT (6)
- WBA** WETLAND BUFFER ADDITION AREA (6)
- SSE** SHORELINE SETBACK ENHANCEMENT AREA (6)
- WC/WR** WETLAND CREATION OR RESTORATION AREA (7)
- WE** WETLAND ENHANCEMENT AREA (5)
- SBE** STREAM BUFFER ENHANCEMENT AREA (6)
- SEEDING FOR REMOVED DRIVEWAYS. NOTE 2.

**CITY OF SAMMAMISH APPROVAL**

City Engineer	Date
Community Development	Date

**REVISED 60% REVIEW SUBMITTAL**  
NOT FOR CONSTRUCTION

REVISIONS	DATE	BY	DESIGNED
			J. SWENSON
			B. PURGANAN
			P. JOHANNESSEN
			Y. HO

**ONE INCH AT FULL SCALE, IF NOT, SCALE ACCORDINGLY**  
FILE NAME: BL1521075P19T03LA-01  
JOB No.: 554-1521-075 P19 T03  
DATE: JULY 2017

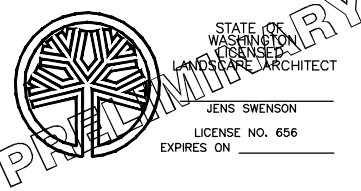

**Parametrix**  
ENGINEERING · PLANNING · ENVIRONMENTAL SCIENCES  
719 2ND AVENUE, SUITE 200 | SEATTLE, WA 98104  
P 206.394.3700  
WWW.PARAMETRIX.COM

PROJECT NAME  
**EAST LAKE SAMMAMISH MASTER PLAN TRAIL SOUTH SAMMAMISH SEGMENT B**  
SAMMAMISH, WA

**Exhibit 16**  
**SSDP2016-00415**  
**LANDSCAPE PLAN 001351**

SHEET NO. 138 OF 158  
**LA4**

PATH: U:\P50\Projects\Clients\1521-075-ELSA\985\CA000\Phase 19\T03\_Civil\Draw\ PLOTTED BY: purgaban DATE: Friday, July 07, 2017 3:07:26 PM LAYOUT: LA5

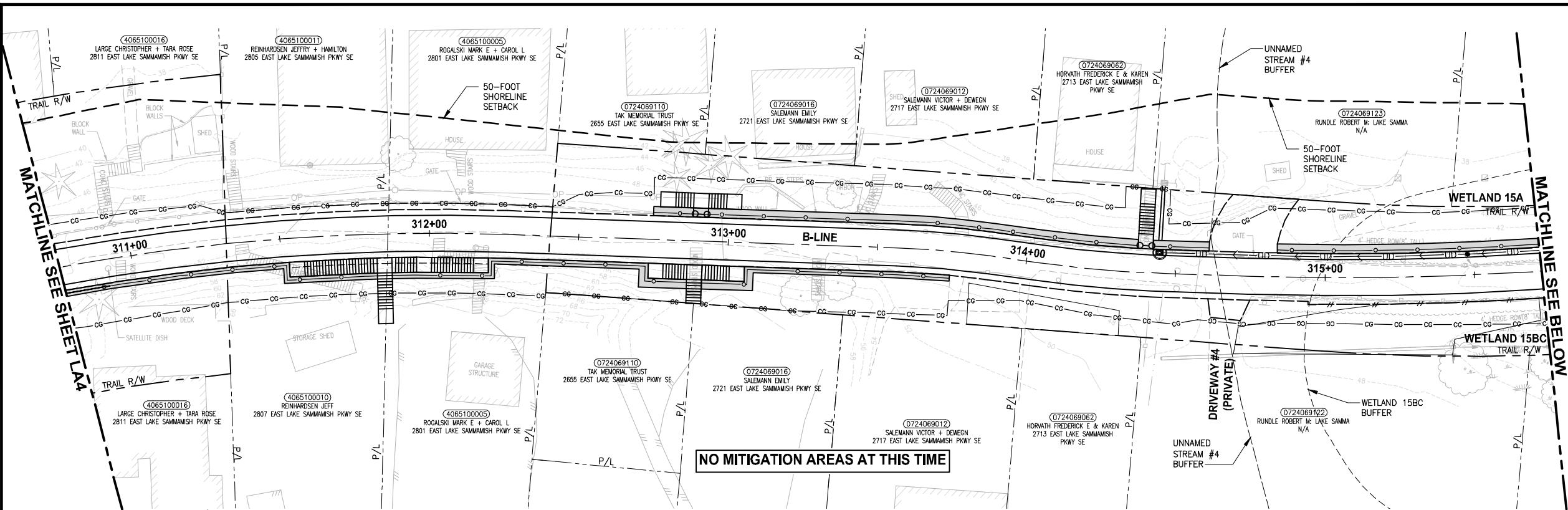

NO MITIGATION AREAS AT THIS TIME

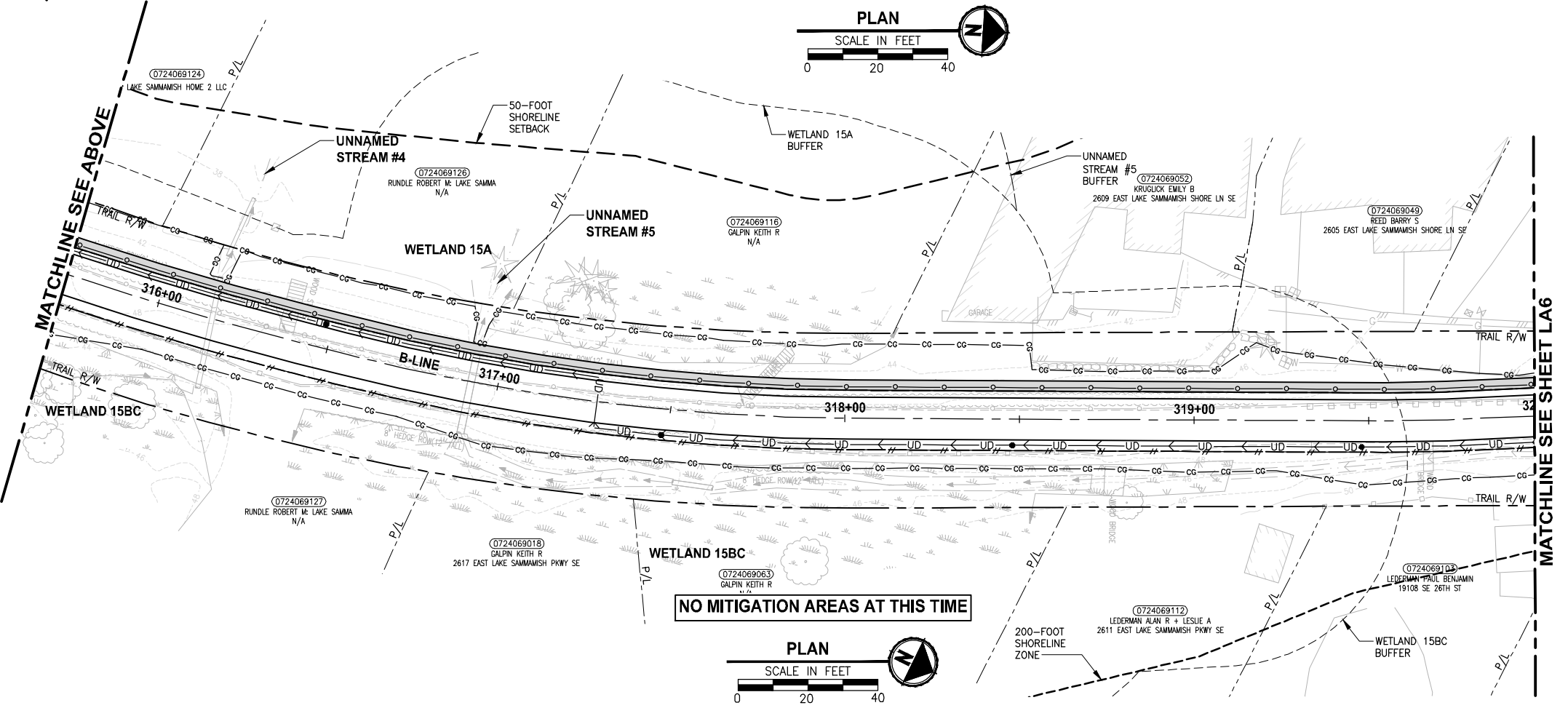
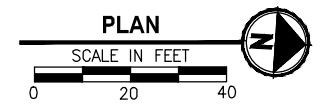

NO MITIGATION AREAS AT THIS TIME

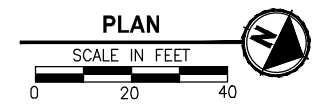

**CONSTRUCTION NOTES:**

- 1 REMOVE LAWN IN THIS AREA.
- 2 REMOVE CONCRETE PAD.
- 3 REMOVE GRAVEL PAVING.
- 4 REMOVE STRUCTURE IN THIS AREA.
- 5 PROTECT EXISTING NATIVE TREES AND SHRUBS; REMOVE BLACKBERRY AND OTHER UNWANTED INVASIVE PLANTS; AMEND SOIL WITH COMPOST; PLANT WITH NATIVE WETLAND PLANTS AND PLACE WOOD CHIP MULCH OVER ENTIRE AREA.
- 6 PROTECT EXISTING NATIVE TREES AND SHRUBS; REMOVE BLACKBERRY AND OTHER UNWANTED INVASIVE PLANTS; AMEND SOIL WITH COMPOST; PLANT WITH NATIVE BUFFER PLANTS AND PLACE WOOD CHIP MULCH OVER ENTIRE AREA.
- 7 GRADE AREA TO CREATE WETLAND CONDITIONS AND AMEND SOIL WITH COMPOST, PLANT WITH NATIVE WETLAND PLANTS.

**GENERAL NOTES:**

1. SEE SHEET LA23 FOR DETAILS AND PLANT LISTS.
2. SEEDING FOR REMOVED DRIVEWAYS IS NOT PART OF THE MITIGATION PLAN.

**LEGEND:**

- WBE WETLAND BUFFER ENHANCEMENT 6
- WBA WETLAND BUFFER ADDITION AREA 6
- SSE SHORELINE SETBACK ENHANCEMENT AREA 6
- WC/WR WETLAND CREATION OR RESTORATION AREA 7
- WE WETLAND ENHANCEMENT AREA 5
- SBE STREAM BUFFER ENHANCEMENT AREA 6
- SEEDING FOR REMOVED DRIVEWAYS. NOTE 2.

CITY OF SAMMAMISH APPROVAL	
City Engineer _____	Date _____
Community Development _____	Date _____

REVISED 60% REVIEW SUBMITTAL  
NOT FOR CONSTRUCTION

Exhibit 16  
SSDP2016-00415  
LANDSCAPE PLAN 001352

REVISIONS	DATE	BY	DESIGNED
			J. SWENSON
			B. PURGANAN
			P. JOHANNESSEN
			Y. HO

ONE INCH AT FULL SCALE.  
IF NOT, SCALE ACCORDINGLY  
FILE NAME: BL1521075P19T03LA-01  
JOB No. 54-1521-075 P19 T03  
DATE: JULY 2017

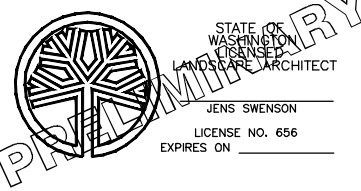

**Parametrix**  
ENGINEERING · PLANNING · ENVIRONMENTAL SCIENCES  
739 2ND AVENUE, SUITE 200 | SEATTLE, WA 98104  
P 206.394.3700  
WWW.PARAMETRIX.COM

PROJECT NAME  
**EAST LAKE SAMMAMISH  
MASTER PLAN TRAIL  
SOUTH SAMMAMISH SEGMENT B**  
SAMMAMISH, WA

SHEET NO.  
139 OF 158  
**LA5**

PATH: U:\P50\Projects\Clients\1521-KingCo\554-1521-075-ELST\95Secs\CADD\Phase 19\T03\_Civil\Drawn PLOTTED BY: purgaban DATE: Friday, July 07, 2017 3:07:51 PM LAYOUT: LA6

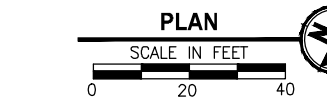
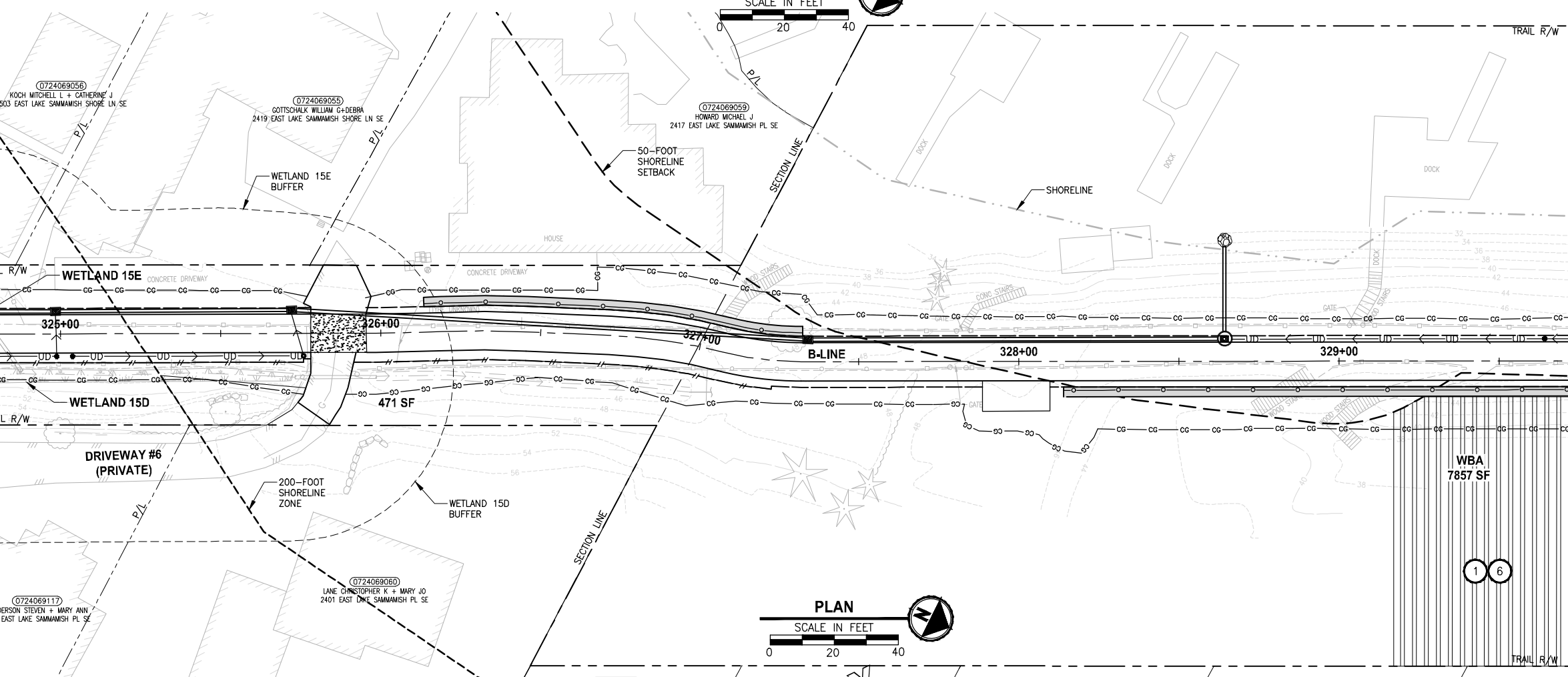
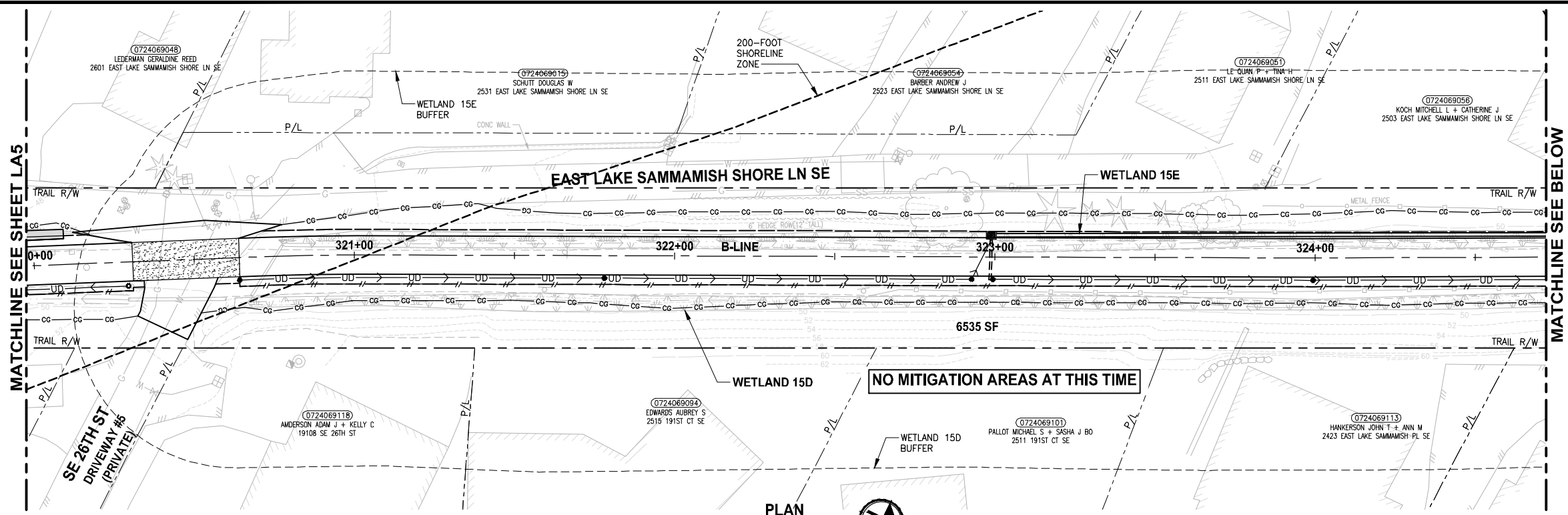

- CONSTRUCTION NOTES:**
- 1 REMOVE LAWN IN THIS AREA.
  - 2 REMOVE CONCRETE PAD.
  - 3 REMOVE GRAVEL PAVING.
  - 4 REMOVE STRUCTURE IN THIS AREA.
  - 5 PROTECT EXISTING NATIVE TREES AND SHRUBS; REMOVE BLACKBERRY AND OTHER UNWANTED INVASIVE PLANTS; AMEND SOIL WITH COMPOST; PLANT WITH NATIVE WETLAND PLANTS AND PLACE WOOD CHIP MULCH OVER ENTIRE AREA.
  - 6 PROTECT EXISTING NATIVE TREES AND SHRUBS; REMOVE BLACKBERRY AND OTHER UNWANTED INVASIVE PLANTS; AMEND SOIL WITH COMPOST; PLANT WITH NATIVE BUFFER PLANTS AND PLACE WOOD CHIP MULCH OVER ENTIRE AREA.
  - 7 GRADE AREA TO CREATE WETLAND CONDITIONS AND AMEND SOIL WITH COMPOST, PLANT WITH NATIVE WETLAND PLANTS.

- GENERAL NOTES:**
1. SEE SHEET LA23 FOR DETAILS AND PLANT LISTS.
  2. SEEDING FOR REMOVED DRIVEWAYS IS NOT PART OF THE MITIGATION PLAN.

- LEGEND:**
- WBE WETLAND BUFFER ENHANCEMENT 6
  - WBA WETLAND BUFFER ADDITION AREA 6
  - SSE SHORELINE SETBACK ENHANCEMENT AREA 6
  - WC/WR WETLAND CREATION OR RESTORATION AREA 7
  - WE WETLAND ENHANCEMENT AREA 5
  - SBE STREAM BUFFER ENHANCEMENT AREA 6
  - SEEDING FOR REMOVED DRIVEWAYS. NOTE 2.

CITY OF SAMMAMISH APPROVAL	
City Engineer _____	Date _____
Community Development _____	Date _____

**REVISED 60% REVIEW SUBMITTAL  
NOT FOR CONSTRUCTION**

**Exhibit 16**  
**SSDP2016-00415**  
**LANDSCAPE PLAN 001353**

REVISIONS	DATE	BY	DESIGNED
			J. SWENSON
			B. PURGANAN
			P. JOHANNESSEN
			Y. HO

**ONE INCH AT FULL SCALE,  
IF NOT, SCALE ACCORDINGLY**  
 FILE NAME: BL1521075P19T03LA-01  
 JOB No: 554-1521-075 P19 T03  
 DATE: JULY 2017

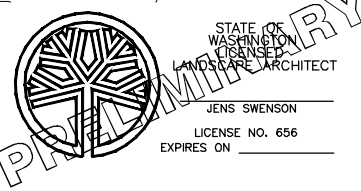

**Parametrix**  
 ENGINEERING · PLANNING · ENVIRONMENTAL SCIENCES  
 719 2ND AVENUE, SUITE 200 | SEATTLE, WA 98104  
 P 206.394.3700  
 WWW.PARAMETRIX.COM

PROJECT NAME  
**EAST LAKE SAMMAMISH  
MASTER PLAN TRAIL  
SOUTH SAMMAMISH SEGMENT B**  
 SAMMAMISH, WA

SHEET NO.  
 140 OF 158  
**LA6**

PATH: U:\P50\Projects\Clients\1521-075-ELSA\985Secs\CADD\Phase 19\T03 CIVIL\DWG\ LAYOUT: LA7 PLOTTED BY: purgaban DATE: Friday, July 07, 2017 3:08:13 PM

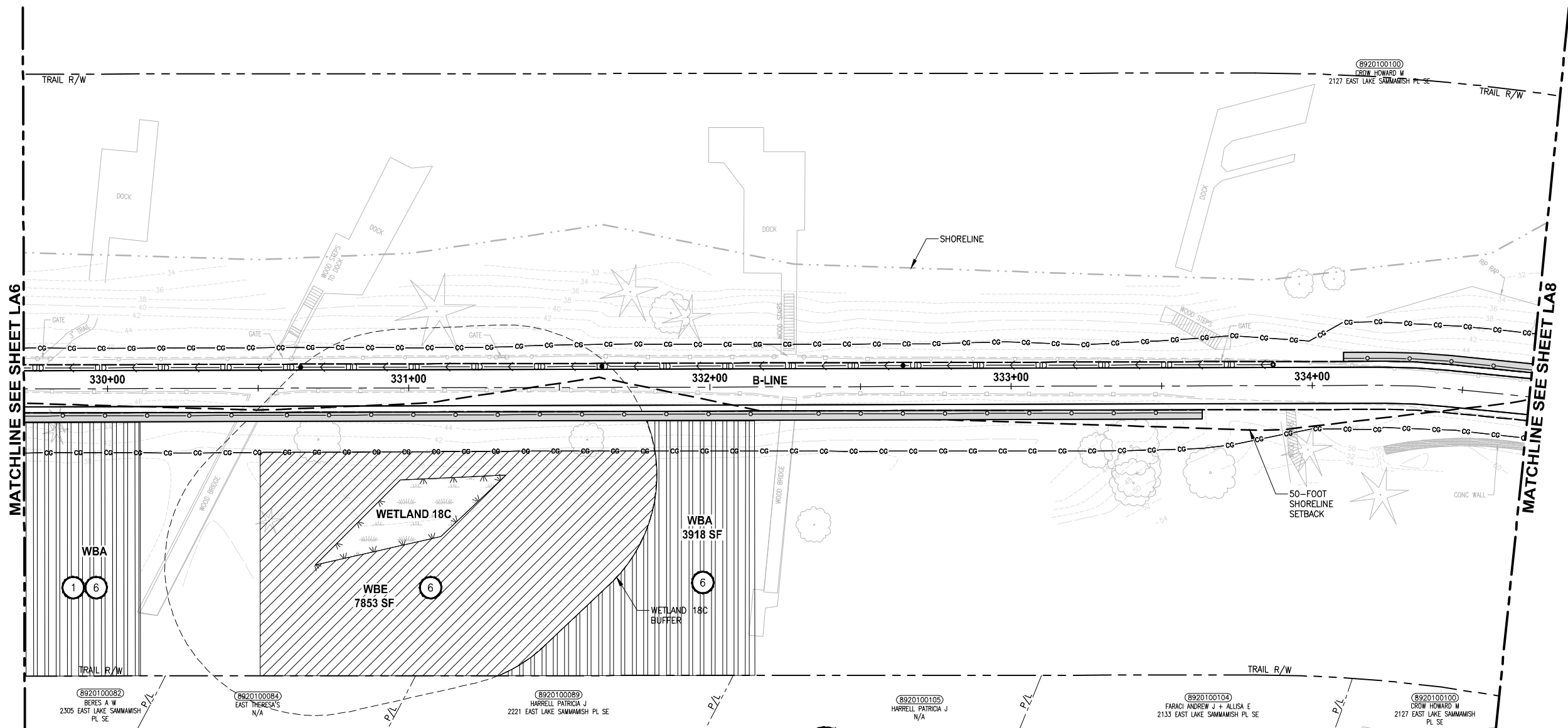

- CONSTRUCTION NOTES:**
- 1 REMOVE LAWN IN THIS AREA.
  - 2 REMOVE CONCRETE PAD.
  - 3 REMOVE GRAVEL PAVING.
  - 4 REMOVE STRUCTURE IN THIS AREA.
  - 5 PROTECT EXISTING NATIVE TREES AND SHRUBS; REMOVE BLACKBERRY AND OTHER UNWANTED INVASIVE PLANTS; AMEND SOIL WITH COMPOST; PLANT WITH NATIVE WETLAND PLANTS AND PLACE WOOD CHIP MULCH OVER ENTIRE AREA.
  - 6 PROTECT EXISTING NATIVE TREES AND SHRUBS; REMOVE BLACKBERRY AND OTHER UNWANTED INVASIVE PLANTS; AMEND SOIL WITH COMPOST; PLANT WITH NATIVE BUFFER PLANTS AND PLACE WOOD CHIP MULCH OVER ENTIRE AREA.
  - 7 GRADE AREA TO CREATE WETLAND CONDITIONS AND AMEND SOIL WITH COMPOST, PLANT WITH NATIVE WETLAND PLANTS.

- GENERAL NOTES:**
1. SEE SHEET LA23 FOR DETAILS AND PLANT LISTS.
  2. SEEDING FOR REMOVED DRIVEWAYS IS NOT PART OF THE MITIGATION PLAN.

- LEGEND:**
- WBE WETLAND BUFFER ENHANCEMENT (6)
  - WBA WETLAND BUFFER ADDITION AREA (6)
  - SSE SHORELINE SETBACK ENHANCEMENT AREA (6)
  - WC/WR WETLAND CREATION OR RESTORATION AREA (7)
  - WE WETLAND ENHANCEMENT AREA (5)
  - SBE STREAM BUFFER ENHANCEMENT AREA (6)
  - SEEDING FOR REMOVED DRIVEWAYS. NOTE 2.

CITY OF SAMMAMISH APPROVAL	
City Engineer _____	Date _____
Community Development _____	Date _____

**REVISED 60% REVIEW SUBMITTAL  
NOT FOR CONSTRUCTION**

**Exhibit 16  
SSDP2016-00415  
LANDSCAPE PLAN 001354**

SHEET NO.  
141 OF 158  
**LA7**

REVISIONS	DATE	BY	DESIGNED
			J. SWENSON
			B. PURGANAN
			P. JOHANNESSEN
			Y. HO

**ONE INCH AT FULL SCALE.  
IF NOT, SCALE ACCORDINGLY**

FILE NAME: BL1521075P19T03LA-02  
JOB No.: 1521-075 P19 T03  
DATE: JULY 2017

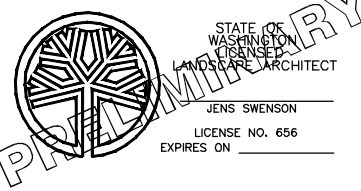

**Parametrix**  
ENGINEERING · PLANNING · ENVIRONMENTAL SCIENCES

719 2ND AVENUE, SUITE 200 | SEATTLE, WA 98104  
P 206.394.3700  
WWW.PARAMETRIX.COM

PROJECT NAME  
**EAST LAKE SAMMAMISH  
MASTER PLAN TRAIL  
SOUTH SAMMAMISH SEGMENT B**  
SAMMAMISH, WA

PATH: U:\PSO\Projects\Clients\1521-075-ELSA\995\995\995\CADD\Phase 19\T03 CIVIL\DWG\ PLOTTED BY: purguban DATE: Friday, July 07, 2017 3:08:34 PM LAYOUT: LAB

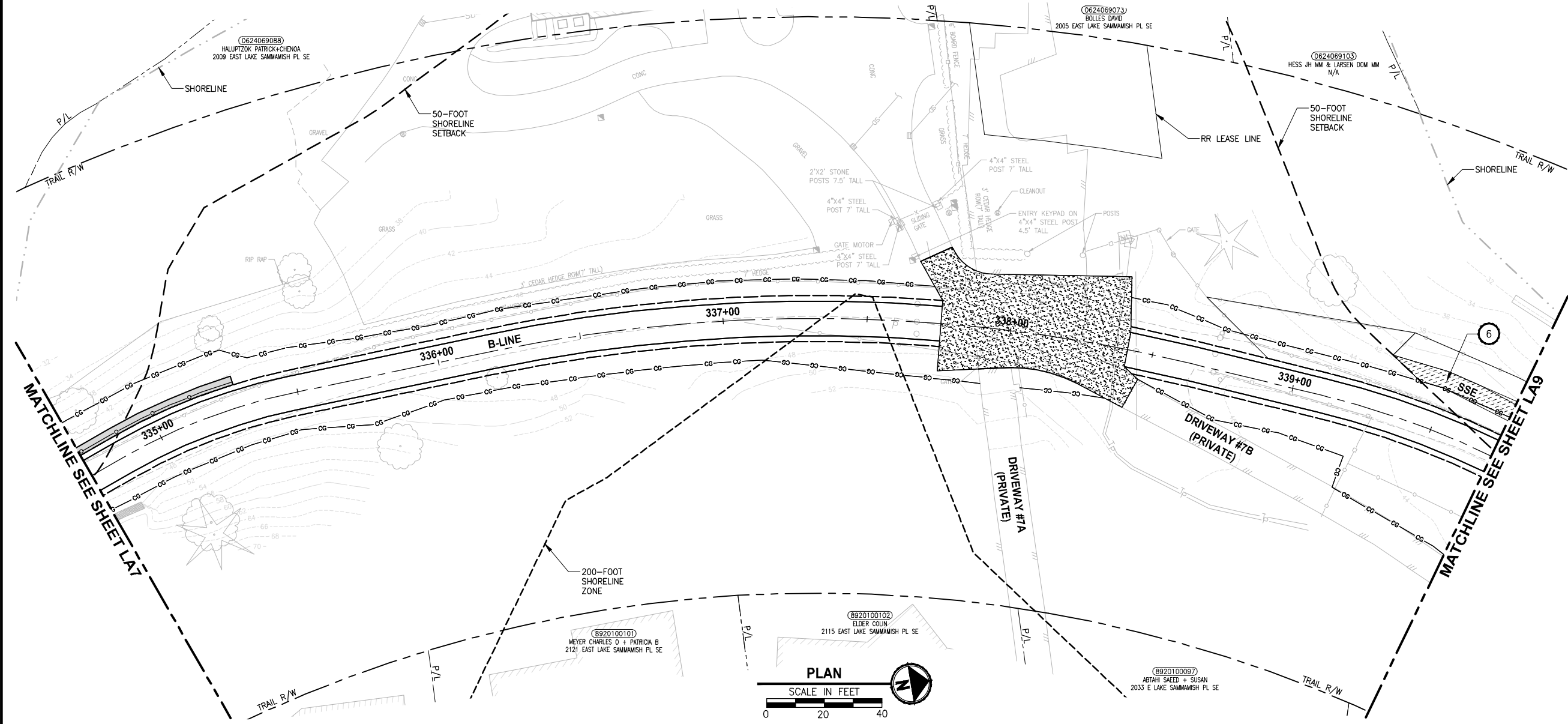

- CONSTRUCTION NOTES:**
- 1 REMOVE LAWN IN THIS AREA.
  - 2 REMOVE CONCRETE PAD.
  - 3 REMOVE GRAVEL PAVING.
  - 4 REMOVE STRUCTURE IN THIS AREA.
  - 5 PROTECT EXISTING NATIVE TREES AND SHRUBS; REMOVE BLACKBERRY AND OTHER UNWANTED INVASIVE PLANTS; AMEND SOIL WITH COMPOST; PLANT WITH NATIVE WETLAND PLANTS AND PLACE WOOD CHIP MULCH OVER ENTIRE AREA.
  - 6 PROTECT EXISTING NATIVE TREES AND SHRUBS; REMOVE BLACKBERRY AND OTHER UNWANTED INVASIVE PLANTS; AMEND SOIL WITH COMPOST; PLANT WITH NATIVE BUFFER PLANTS AND PLACE WOOD CHIP MULCH OVER ENTIRE AREA.
  - 7 GRADE AREA TO CREATE WETLAND CONDITIONS AND AMEND SOIL WITH COMPOST, PLANT WITH NATIVE WETLAND PLANTS.

- GENERAL NOTES:**
1. SEE SHEET LA23 FOR DETAILS AND PLANT LISTS.
  2. SEEDING FOR REMOVED DRIVEWAYS IS NOT PART OF THE MITIGATION PLAN.

**LEGEND:**

	WETLAND BUFFER ENHANCEMENT	6
	WETLAND BUFFER ADDITION AREA	6
	SHORELINE SETBACK ENHANCEMENT AREA	6
	WETLAND CREATION OR RESTORATION AREA	7
	WETLAND ENHANCEMENT AREA	5
	STREAM BUFFER ENHANCEMENT AREA	6
	SEEDING FOR REMOVED DRIVEWAYS. NOTE 2.	

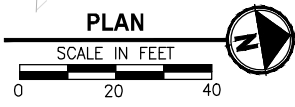

CITY OF SAMMAMISH APPROVAL	
City Engineer _____	Date _____
Community Development _____	Date _____

**REVISED 60% REVIEW SUBMITTAL  
NOT FOR CONSTRUCTION**

**Exhibit 16  
SSDP2016-00415  
LANDSCAPE PLAN 001355**

SHEET NO.  
142 OF 158  
**LA8**

REVISIONS	DATE	BY	DESIGNED
			J. SWENSON
			B. PURGANAN
			P. JOHANNESSEN
			Y. HO

ONE INCH AT FULL SCALE.  
IF NOT, SCALE ACCORDINGLY  
FILE NAME: BL1521075P19T03LA-02  
JOB No. 54-1521-075 P19 T03  
DATE: JULY 2017

STATE OF WASHINGTON  
LANDSCAPE ARCHITECT  
JENS SWENSON  
LICENSE NO. 656  
EXPIRES ON \_\_\_\_\_

**Parametrix**  
ENGINEERING · PLANNING · ENVIRONMENTAL SCIENCES  
719 2ND AVENUE, SUITE 200 | SEATTLE, WA 98104  
P 206.394.3700  
WWW.PARAMETRIX.COM

PROJECT NAME  
**EAST LAKE SAMMAMISH  
MASTER PLAN TRAIL  
SOUTH SAMMAMISH SEGMENT B**  
SAMMAMISH, WA



U:\P50\Projects\Clients\1521-075-ELSA\99\Specs\CADD\Phase 19\T03\_Civil\Drawg\ PLOTTED BY: purgabat DATE: Friday, July 07, 2017 3:10:05 PM

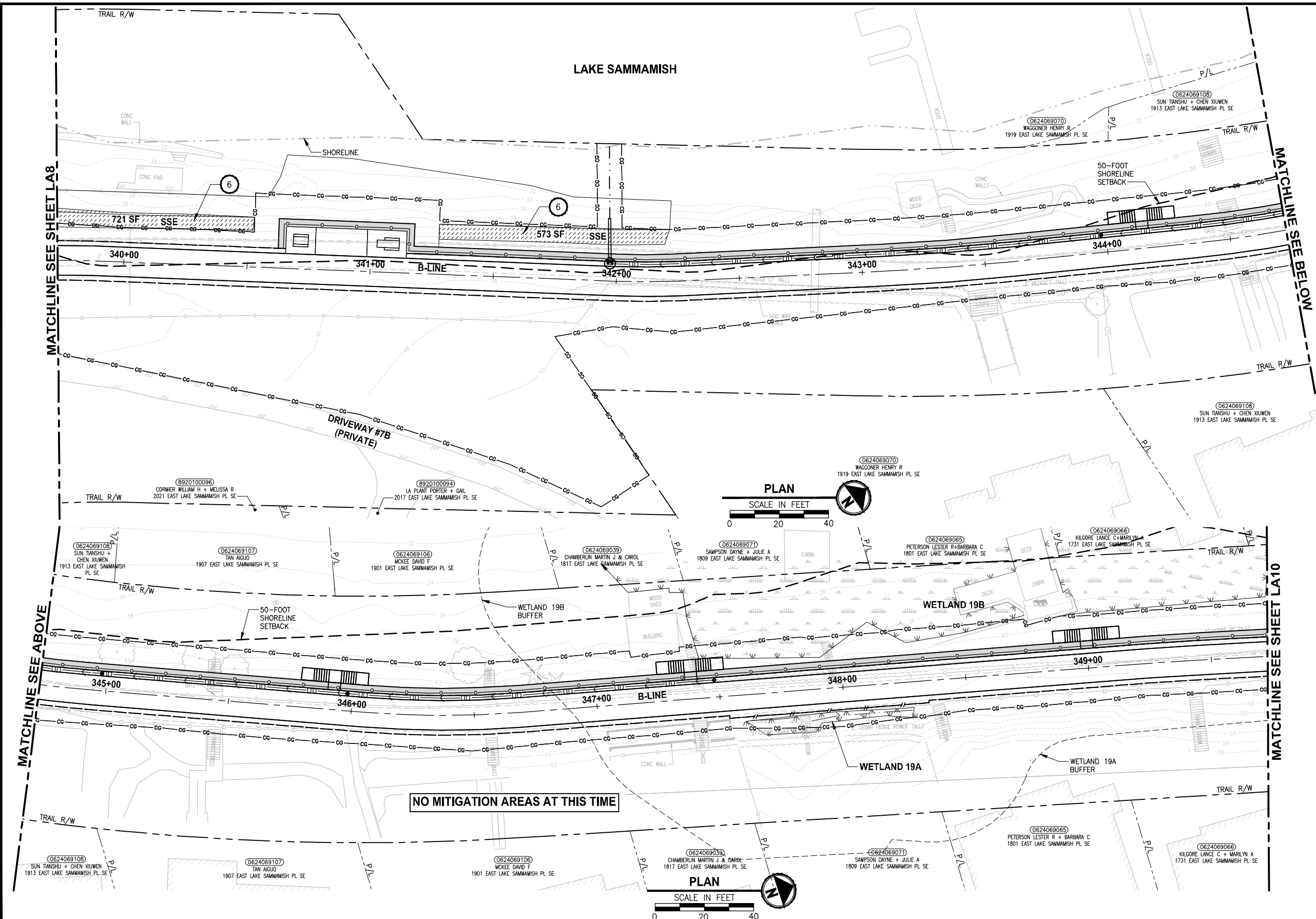

NO MITIGATION AREAS AT THIS TIME

- CONSTRUCTION NOTES:**
- 1 REMOVE LAWN IN THIS AREA.
  - 2 REMOVE CONCRETE PAD.
  - 3 REMOVE GRAVEL PAVING.
  - 4 REMOVE STRUCTURE IN THIS AREA.
  - 5 PROTECT EXISTING NATIVE TREES AND SHRUBS; REMOVE BLACKBERRY AND OTHER UNWANTED INVASIVE PLANTS; AMEND SOIL WITH COMPOST; PLANT WITH NATIVE WETLAND PLANTS AND PLACE WOOD CHIP MULCH OVER ENTIRE AREA.
  - 6 PROTECT EXISTING NATIVE TREES AND SHRUBS; REMOVE BLACKBERRY AND OTHER UNWANTED INVASIVE PLANTS; AMEND SOIL WITH COMPOST; PLANT WITH NATIVE BUFFER PLANTS AND PLACE WOOD CHIP MULCH OVER ENTIRE AREA.
  - 7 GRADE AREA TO CREATE WETLAND CONDITIONS AND AMEND SOIL WITH COMPOST, PLANT WITH NATIVE WETLAND PLANTS.

- GENERAL NOTES:**
1. SEE SHEET LA23 FOR DETAILS AND PLANT LISTS.
  2. SEEDING FOR REMOVED DRIVEWAYS IS NOT PART OF THE MITIGATION PLAN.

- LEGEND:**
- WBE WETLAND BUFFER ENHANCEMENT (6)
  - WBA WETLAND BUFFER ADDITION AREA (6)
  - SSE SHORELINE SETBACK ENHANCEMENT AREA (6)
  - WC/WR WETLAND CREATION OR RESTORATION AREA (7)
  - WE WETLAND ENHANCEMENT AREA (5)
  - SBE STREAM BUFFER ENHANCEMENT AREA (6)
  - SEEDING FOR REMOVED DRIVEWAYS. NOTE 2.

CITY OF SAMMAMISH APPROVAL

City Engineer	Date
Community Development	Date

REVISED 60% REVIEW SUBMITTAL  
NOT FOR CONSTRUCTION

Exhibit 16  
SSDP2016-00415  
LANDSCAPE PLAN 001356

REVISIONS	DATE	BY	DESIGNED
			J. SWENSON
			B. PURGANAN
			P. JOHANNESSEN
			Y. HO

STATE OF WASHINGTON  
LANDSCAPE ARCHITECT

JENS SWENSON  
LICENSE NO. 656  
EXPIRES ON

ONE INCH AT FULL SCALE.  
IF NOT, SCALE ACCORDINGLY

FILE NAME: BL1521075P19T03LA-02  
JOB No.: 54-1521-075 P19 T03  
DATE: JULY 2017

**Parametrix**  
ENGINEERING · PLANNING · ENVIRONMENTAL SCIENCES

719 2ND AVENUE, SUITE 200 | SEATTLE, WA 98104  
P 206.394.3700  
WWW.PARAMETRIX.COM

PROJECT NAME

**EAST LAKE SAMMAMISH  
MASTER PLAN TRAIL  
SOUTH SAMMAMISH SEGMENT B**

SAMMAMISH, WA

SHEET NO.  
143 OF 158

**LA9**

LAYOUT: LA10  
 PATH: J:\PSO\Projects\Clients\1521-KingCo\554-1521-075-ELST-985\CA\ADD\Phase 19\_T03\_Civil\DWG\ PLOTTED BY: purgobut DATE: Friday, July 07, 2017 3:10:35 PM

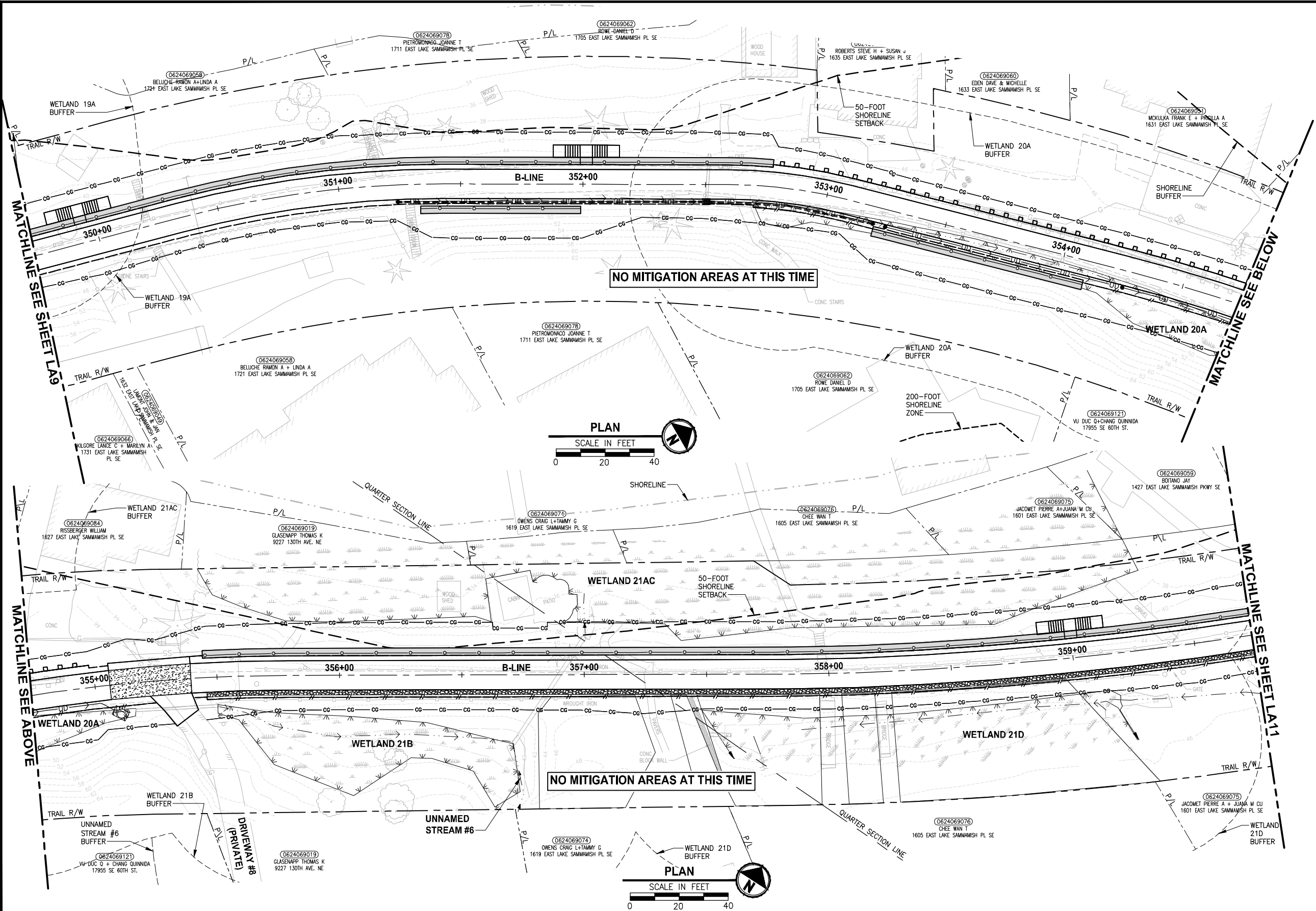

NO MITIGATION AREAS AT THIS TIME

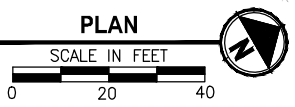

NO MITIGATION AREAS AT THIS TIME

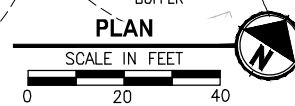

- CONSTRUCTION NOTES:**
- 1 REMOVE LAWN IN THIS AREA.
  - 2 REMOVE CONCRETE PAD.
  - 3 REMOVE GRAVEL PAVING.
  - 4 REMOVE STRUCTURE IN THIS AREA.
  - 5 PROTECT EXISTING NATIVE TREES AND SHRUBS; REMOVE BLACKBERRY AND OTHER UNWANTED INVASIVE PLANTS; AMEND SOIL WITH COMPOST; PLANT WITH NATIVE WETLAND PLANTS AND PLACE WOOD CHIP MULCH OVER ENTIRE AREA.
  - 6 PROTECT EXISTING NATIVE TREES AND SHRUBS; REMOVE BLACKBERRY AND OTHER UNWANTED INVASIVE PLANTS; AMEND SOIL WITH COMPOST; PLANT WITH NATIVE BUFFER PLANTS AND PLACE WOOD CHIP MULCH OVER ENTIRE AREA.
  - 7 GRADE AREA TO CREATE WETLAND CONDITIONS AND AMEND SOIL WITH COMPOST, PLANT WITH NATIVE WETLAND PLANTS.

- GENERAL NOTES:**
1. SEE SHEET LA23 FOR DETAILS AND PLANT LISTS.
  2. SEEDING FOR REMOVED DRIVEWAYS IS NOT PART OF THE MITIGATION PLAN.

- LEGEND:**
- WBE WETLAND BUFFER ENHANCEMENT (6)
  - WBA WETLAND BUFFER ADDITION AREA (6)
  - SSE SHORELINE SETBACK ENHANCEMENT AREA (6)
  - WC/WR WETLAND CREATION OR RESTORATION AREA (7)
  - WE WETLAND ENHANCEMENT AREA (5)
  - SBE STREAM BUFFER ENHANCEMENT AREA (6)
  - SEEDING FOR REMOVED DRIVEWAYS. NOTE 2.

CITY OF SAMMAMISH APPROVAL	
City Engineer _____	Date _____
Community Development _____	Date _____

**REVISED 60% REVIEW SUBMITTAL  
NOT FOR CONSTRUCTION**

**Exhibit 16**  
**SSDP2016-00415**  
**LANDSCAPE PLAN 001357**  
 SHEET NO. 144 OF 158  
**LA10**

REVISIONS	DATE	BY	DESIGNED
			J. SWENSON
			B. PURGANAN
			P. JOHANNESSEN
			Y. HO

**ONE INCH AT FULL SCALE, IF NOT, SCALE ACCORDINGLY**  
 FILE NAME: BL1521075P19T03LA-02  
 JOB No.: 554-1521-075 P19 T03  
 DATE: JULY 2017

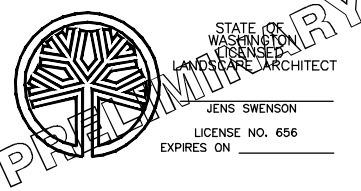

**Parametrix**  
 ENGINEERING · PLANNING · ENVIRONMENTAL SCIENCES  
 719 2ND AVENUE, SUITE 200 | SEATTLE, WA 98104  
 P 206.394.3700  
 WWW.PARAMETRIX.COM

PROJECT NAME:  
**EAST LAKE SAMMAMISH  
 MASTER PLAN TRAIL  
 SOUTH SAMMAMISH SEGMENT B**  
 SAMMAMISH, WA

PATH: U:\PSO\Projects\Clients\1521-KingCo\_564-1521-075-ELST-98Secs\CADD\Phase 19\T03\_Civil\DWG\ PLOTTED BY: purgabut DATE: Friday, July 07, 2017 3:11:05 PM LAYOUT: LA11

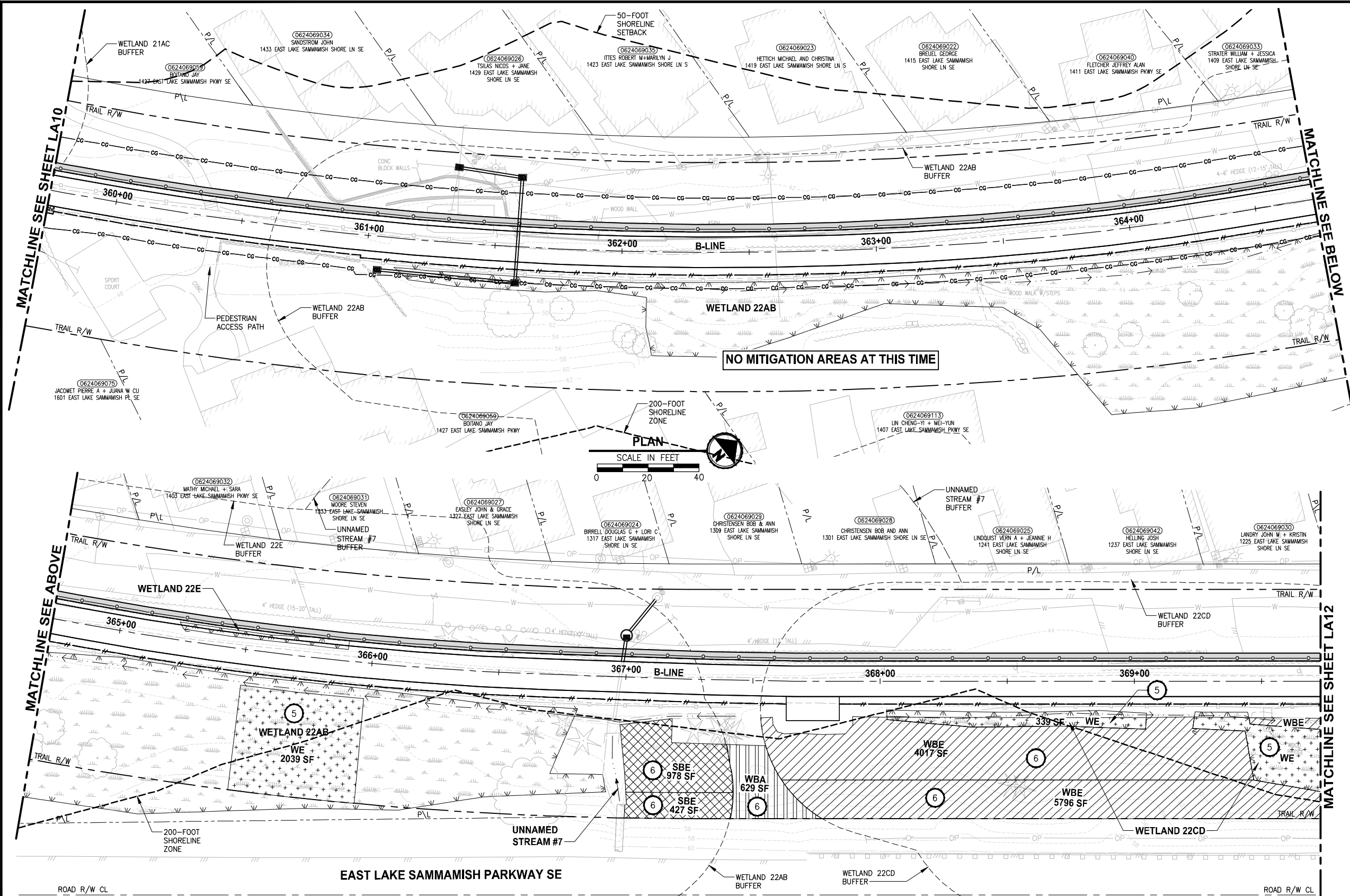

**REVISIONS**

NO.	REVISIONS	DATE	BY	DESIGNED	CHECKED	APPROVED
1				J. SWENSON	P. JOHANNESSEN	Y. HO

**ONE INCH AT FULL SCALE, IF NOT, SCALE ACCORDINGLY**

FILE NAME: BL1521075P19T03LA-02  
 JOB No: 564-1521-075 P19 T03  
 DATE: JULY 2017

STATE OF WASHINGTON  
 LANDSCAPE ARCHITECT

JENS SWENSON  
 LICENSE NO. 656  
 EXPIRES ON \_\_\_\_\_

**Parametrix**  
 ENGINEERING · PLANNING · ENVIRONMENTAL SCIENCES

739 2ND AVENUE, SUITE 200 | SEATTLE, WA 98104  
 P 206.394.3700  
 WWW.PARAMETRIX.COM

PROJECT NAME:  
**EAST LAKE SAMMAMISH  
 MASTER PLAN TRAIL  
 SOUTH SAMMAMISH SEGMENT B**  
 SAMMAMISH, WA

- CONSTRUCTION NOTES:**
- REMOVE LAWN IN THIS AREA.
  - REMOVE CONCRETE PAD.
  - REMOVE GRAVEL PAVING.
  - REMOVE STRUCTURE IN THIS AREA.
  - PROTECT EXISTING NATIVE TREES AND SHRUBS; REMOVE BLACKBERRY AND OTHER UNWANTED INVASIVE PLANTS; AMEND SOIL WITH COMPOST; PLANT WITH NATIVE WETLAND PLANTS AND PLACE WOOD CHIP MULCH OVER ENTIRE AREA.
  - PROTECT EXISTING NATIVE TREES AND SHRUBS; REMOVE BLACKBERRY AND OTHER UNWANTED INVASIVE PLANTS; AMEND SOIL WITH COMPOST; PLANT WITH NATIVE BUFFER PLANTS AND PLACE WOOD CHIP MULCH OVER ENTIRE AREA.
  - GRADE AREA TO CREATE WETLAND CONDITIONS AND AMEND SOIL WITH COMPOST, PLANT WITH NATIVE WETLAND PLANTS.

- GENERAL NOTES:**
- SEE SHEET LA23 FOR DETAILS AND PLANT LISTS.
  - SEEDING FOR REMOVED DRIVEWAYS IS NOT PART OF THE MITIGATION PLAN.

**LEGEND:**

	WETLAND BUFFER ENHANCEMENT	6
	WETLAND BUFFER ADDITION AREA	6
	SHORELINE SETBACK ENHANCEMENT AREA	6
	WETLAND CREATION OR RESTORATION AREA	7
	WETLAND ENHANCEMENT AREA	5
	STREAM BUFFER ENHANCEMENT AREA	6
	SEEDING FOR REMOVED DRIVEWAYS. NOTE 2.	

CITY OF SAMMAMISH APPROVAL

City Engineer _____	Date _____
Community Development _____	Date _____

**REVISED 60% REVIEW SUBMITTAL  
 NOT FOR CONSTRUCTION**

**Exhibit 16**  
**SSDP2016-00415**  
**LANDSCAPE PLAN 001358**  
 SHEET NO. 145 OF 158  
**LA11**

LAYOUT: LA12  
 PATH: J:\PSO\Projects\Clients\1521-KingCo\554-1521-075-ELST\995\cs\CA\DD\Phase 19\_T03\_Civil\DWG\ PLOTTED BY: purgaban DATE: Friday, July 07, 2017 3:12:37 PM

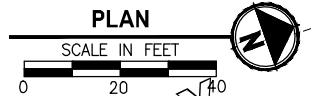
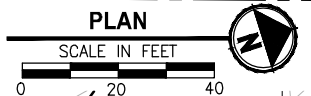
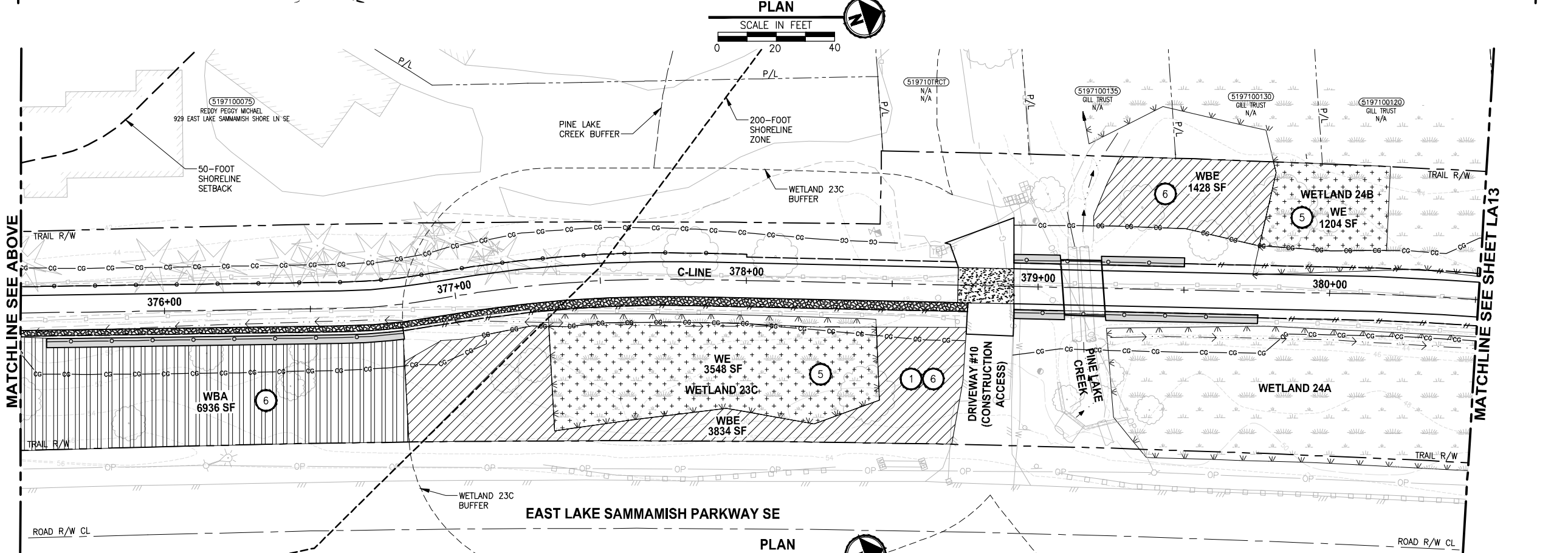
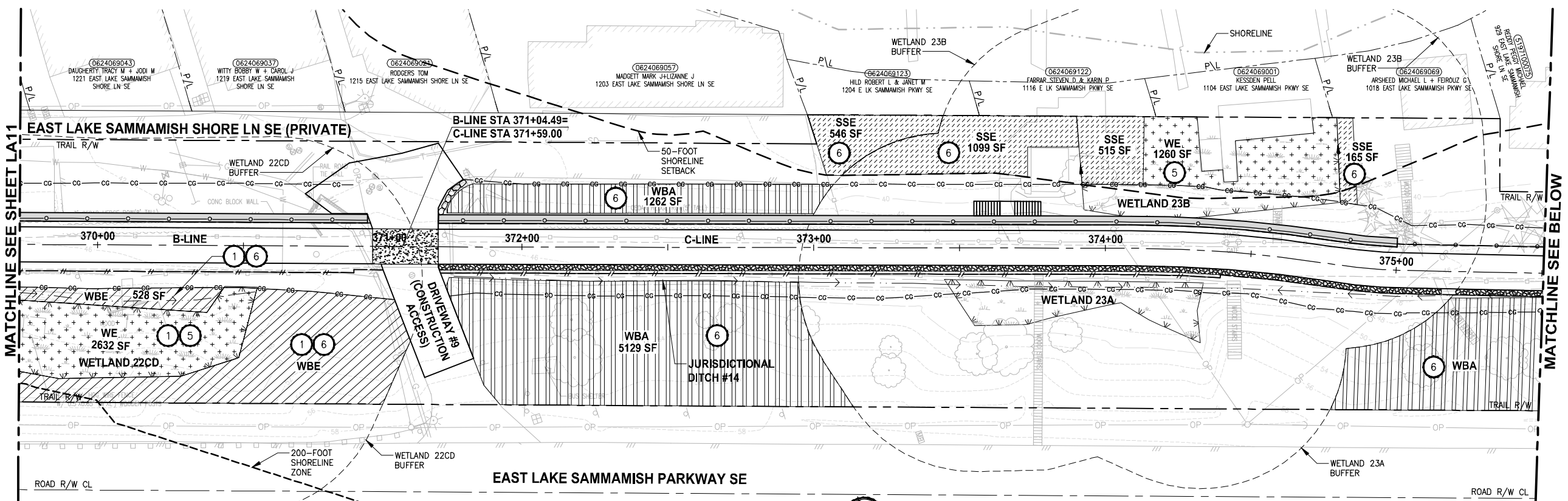

- CONSTRUCTION NOTES:**
- 1 REMOVE LAWN IN THIS AREA.
  - 2 REMOVE CONCRETE PAD.
  - 3 REMOVE GRAVEL PAVING.
  - 4 REMOVE STRUCTURE IN THIS AREA.
  - 5 PROTECT EXISTING NATIVE TREES AND SHRUBS; REMOVE BLACKBERRY AND OTHER UNWANTED INVASIVE PLANTS; AMEND SOIL WITH COMPOST; PLANT WITH NATIVE WETLAND PLANTS AND PLACE WOOD CHIP MULCH OVER ENTIRE AREA.
  - 6 PROTECT EXISTING NATIVE TREES AND SHRUBS; REMOVE BLACKBERRY AND OTHER UNWANTED INVASIVE PLANTS; AMEND SOIL WITH COMPOST; PLANT WITH NATIVE BUFFER PLANTS AND PLACE WOOD CHIP MULCH OVER ENTIRE AREA.
  - 7 GRADE AREA TO CREATE WETLAND CONDITIONS AND AMEND SOIL WITH COMPOST, PLANT WITH NATIVE WETLAND PLANTS.

- GENERAL NOTES:**
1. SEE SHEET LA23 FOR DETAILS AND PLANT LISTS.
  2. SEEDING FOR REMOVED DRIVEWAYS IS NOT PART OF THE MITIGATION PLAN.

- LEGEND:**
- WBE WETLAND BUFFER ENHANCEMENT (6)
  - WBA WETLAND BUFFER ADDITION AREA (6)
  - SSE SHORELINE SETBACK ENHANCEMENT AREA (6)
  - WC/WR WETLAND CREATION OR RESTORATION AREA (7)
  - WE WETLAND ENHANCEMENT AREA (5)
  - SBE STREAM BUFFER ENHANCEMENT AREA (6)
  - SEEDING FOR REMOVED DRIVEWAYS. NOTE 2.

CITY OF SAMMAMISH APPROVAL	
City Engineer _____	Date _____
Community Development _____	Date _____

**REVISED 60% REVIEW SUBMITTAL  
NOT FOR CONSTRUCTION**

**Exhibit 16**  
**SSDP2016-00415**  
**LANDSCAPE PLAN 001359**  
 SHEET NO. 146 OF 158  
**LA12**

REVISIONS	DATE	BY	DESIGNED
			J. SWENSON
			B. PURGANAN
			P. JOHANNESSEN
			Y. HO

**ONE INCH AT FULL SCALE, IF NOT, SCALE ACCORDINGLY**  
 FILE NAME: BL1521075P19T03LA-03  
 JOB No.: 554-1521-075 P19 T03  
 DATE: JULY 2017

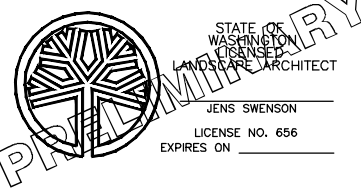

**Parametrix**  
 ENGINEERING · PLANNING · ENVIRONMENTAL SCIENCES  
 719 2ND AVENUE, SUITE 200 | SEATTLE, WA 98104  
 P 206.394.3700  
 WWW.PARAMETRIX.COM

PROJECT NAME:  
**EAST LAKE SAMMAMISH  
 MASTER PLAN TRAIL  
 SOUTH SAMMAMISH SEGMENT B**  
 SAMMAMISH, WA

LAYOUT: LA13  
 PATH: J:\PSO\Projects\Clients\1521-075-ELST\985\CA\ADD\Phase 19\_T03\_Civil\DWG\ PLOTTED BY: purgobut DATE: Friday, July 07, 2017 3:13:02 PM

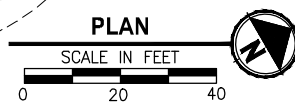
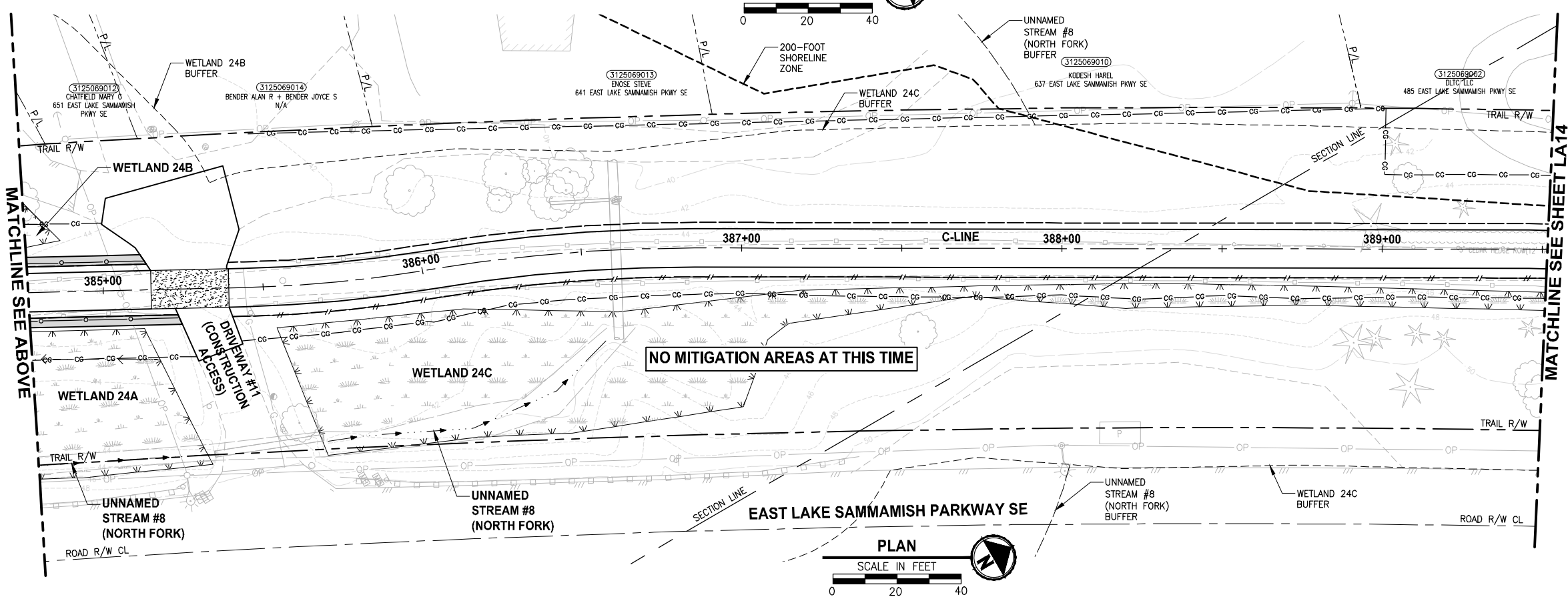
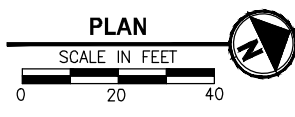
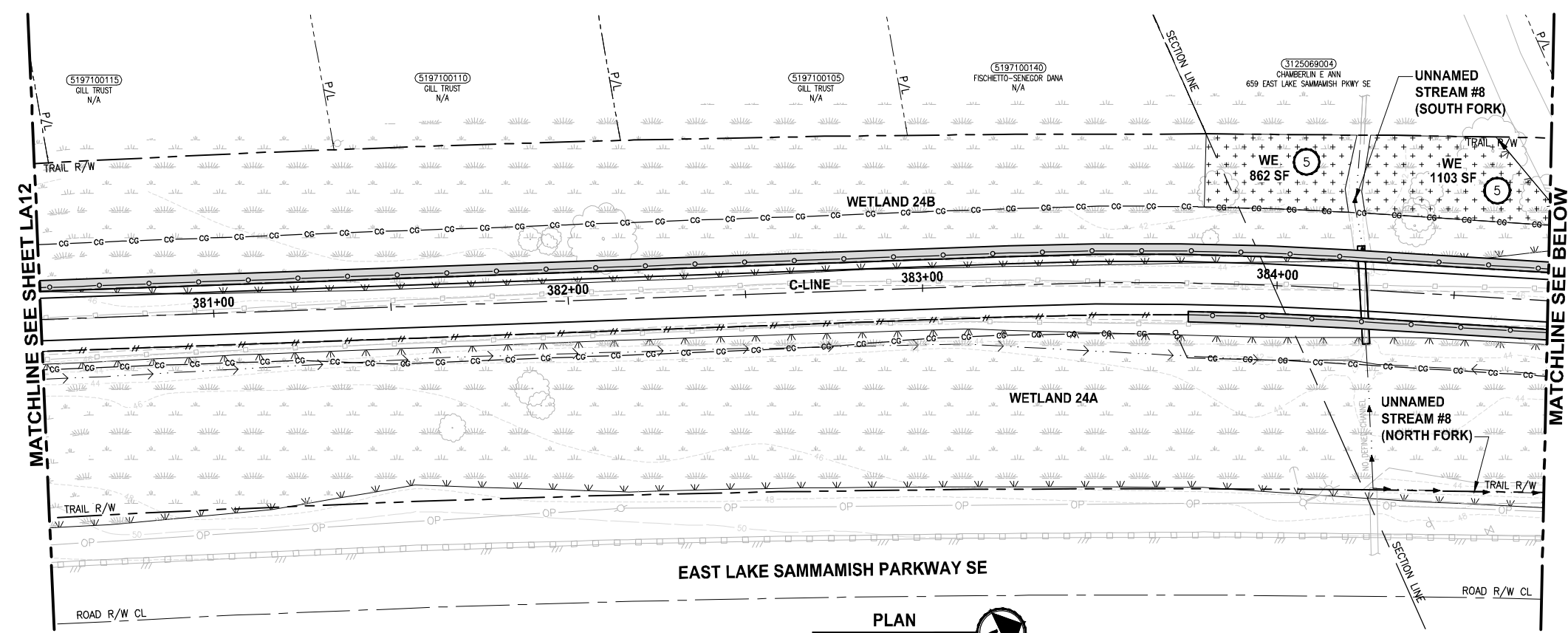

- CONSTRUCTION NOTES:**
- 1 REMOVE LAWN IN THIS AREA.
  - 2 REMOVE CONCRETE PAD.
  - 3 REMOVE GRAVEL PAVING.
  - 4 REMOVE STRUCTURE IN THIS AREA.
  - 5 PROTECT EXISTING NATIVE TREES AND SHRUBS; REMOVE BLACKBERRY AND OTHER UNWANTED INVASIVE PLANTS; AMEND SOIL WITH COMPOST; PLANT WITH NATIVE WETLAND PLANTS AND PLACE WOOD CHIP MULCH OVER ENTIRE AREA.
  - 6 PROTECT EXISTING NATIVE TREES AND SHRUBS; REMOVE BLACKBERRY AND OTHER UNWANTED INVASIVE PLANTS; AMEND SOIL WITH COMPOST; PLANT WITH NATIVE BUFFER PLANTS AND PLACE WOOD CHIP MULCH OVER ENTIRE AREA.
  - 7 GRADE AREA TO CREATE WETLAND CONDITIONS AND AMEND SOIL WITH COMPOST, PLANT WITH NATIVE WETLAND PLANTS.

- GENERAL NOTES:**
1. SEE SHEET LA23 FOR DETAILS AND PLANT LISTS.
  2. SEEDING FOR REMOVED DRIVEWAYS IS NOT PART OF THE MITIGATION PLAN.

- LEGEND:**
- WBE WETLAND BUFFER ENHANCEMENT (6)
  - WBA WETLAND BUFFER ADDITION AREA (6)
  - SSE SHORELINE SETBACK ENHANCEMENT AREA (6)
  - WC/WR WETLAND CREATION OR RESTORATION AREA (7)
  - WE WETLAND ENHANCEMENT AREA (5)
  - SBE STREAM BUFFER ENHANCEMENT AREA (6)
  - SEEDING FOR REMOVED DRIVEWAYS. NOTE 2.

CITY OF SAMMAMISH APPROVAL	
City Engineer _____	Date _____
Community Development _____	Date _____

**REVISED 60% REVIEW SUBMITTAL  
NOT FOR CONSTRUCTION**

**Exhibit 16**  
**SSDP2016-00415**  
**LANDSCAPE PLAN 001360**

REVISIONS	DATE	BY	DESIGNED	CHECKED	APPROVED
			J. SWENSON		
			B. PURGANAN		
			P. JOHANNESSEN		
			Y. HO		

**ONE INCH AT FULL SCALE,  
 IF NOT, SCALE ACCORDINGLY**  
 FILE NAME  
 BL1521075P19T03LA-03  
 JOB No.  
 54-1521-075 P19 T03  
 DATE  
 JULY 2017

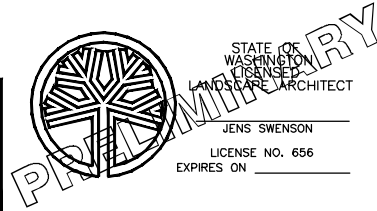

**Parametrix**  
 ENGINEERING · PLANNING · ENVIRONMENTAL SCIENCES  
 719 2ND AVENUE, SUITE 200 | SEATTLE, WA 98104  
 P 206.394.3700  
 WWW.PARAMETRIX.COM

PROJECT NAME  
**EAST LAKE SAMMAMISH  
 MASTER PLAN TRAIL  
 SOUTH SAMMAMISH SEGMENT B**  
 SAMMAMISH, WA

SHEET NO.  
 147 OF 158  
**LA13**

PATH: J:\PSO\Projects\Clients\1521-KingCo\554-1521-075-ELST\995\cs\CADD\Phase 19\T03\_Civil\DWG\ LAYOUT: LA14 PLOTTED BY: pargobut DATE: Friday, July 07, 2017 3:13:28 PM

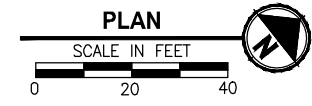
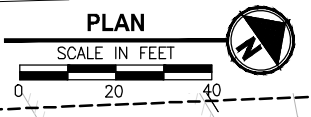
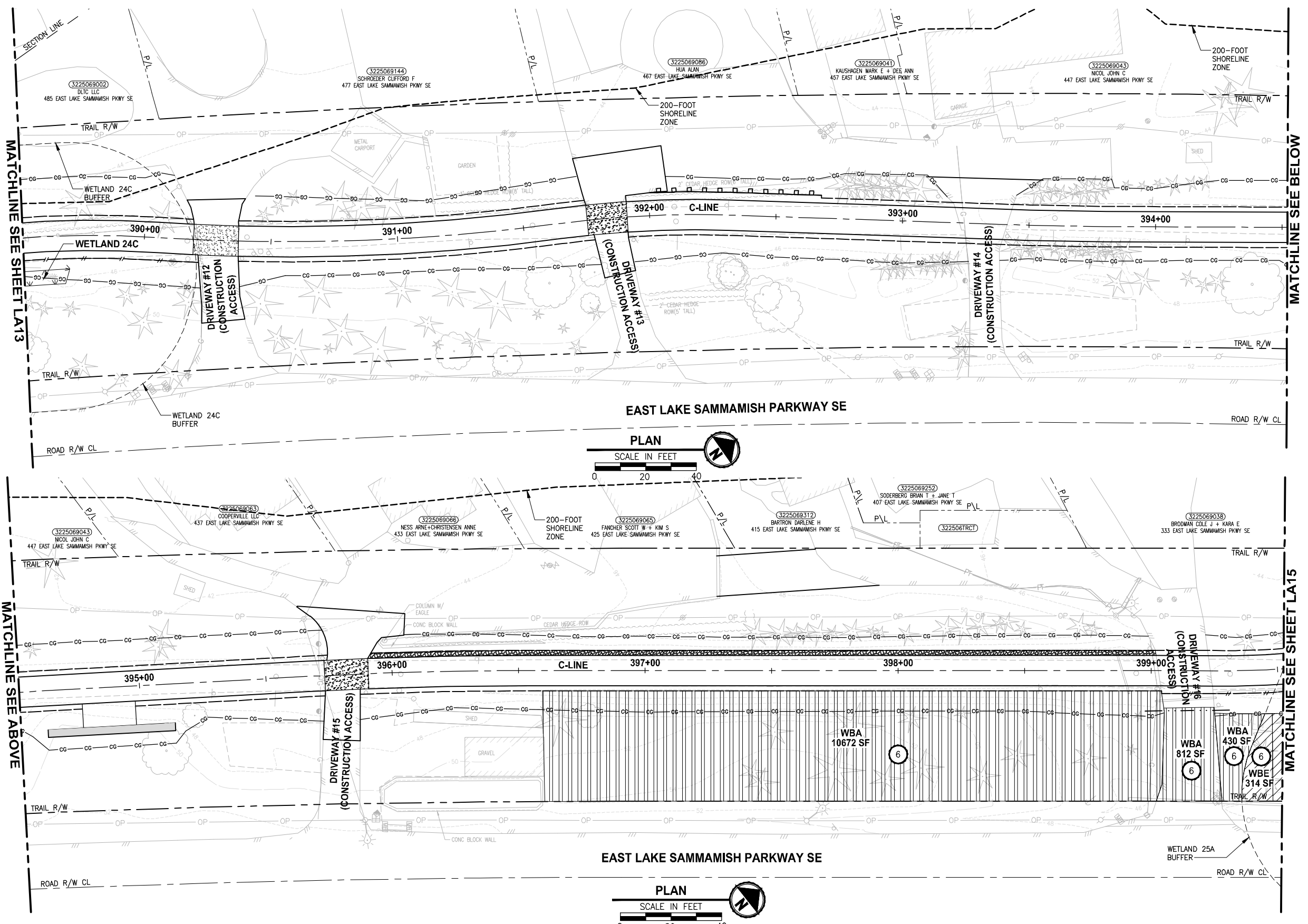

- CONSTRUCTION NOTES:**
- 1 REMOVE LAWN IN THIS AREA.
  - 2 REMOVE CONCRETE PAD.
  - 3 REMOVE GRAVEL PAVING.
  - 4 REMOVE STRUCTURE IN THIS AREA.
  - 5 PROTECT EXISTING NATIVE TREES AND SHRUBS; REMOVE BLACKBERRY AND OTHER UNWANTED INVASIVE PLANTS; AMEND SOIL WITH COMPOST; PLANT WITH NATIVE WETLAND PLANTS AND PLACE WOOD CHIP MULCH OVER ENTIRE AREA.
  - 6 PROTECT EXISTING NATIVE TREES AND SHRUBS; REMOVE BLACKBERRY AND OTHER UNWANTED INVASIVE PLANTS; AMEND SOIL WITH COMPOST; PLANT WITH NATIVE BUFFER PLANTS AND PLACE WOOD CHIP MULCH OVER ENTIRE AREA.
  - 7 GRADE AREA TO CREATE WETLAND CONDITIONS AND AMEND SOIL WITH COMPOST, PLANT WITH NATIVE WETLAND PLANTS.

- GENERAL NOTES:**
1. SEE SHEET LA23 FOR DETAILS AND PLANT LISTS.
  2. SEEDING FOR REMOVED DRIVEWAYS IS NOT PART OF THE MITIGATION PLAN.

- LEGEND:**
- WBE WETLAND BUFFER ENHANCEMENT (6)
  - WBA WETLAND BUFFER ADDITION AREA (6)
  - SSE SHORELINE SETBACK ENHANCEMENT AREA (6)
  - WC/WR WETLAND CREATION OR RESTORATION AREA (7)
  - WE WETLAND ENHANCEMENT AREA (5)
  - SBE STREAM BUFFER ENHANCEMENT AREA (6)
  - SEEDING FOR REMOVED DRIVEWAYS. NOTE 2.

CITY OF SAMMAMISH APPROVAL	
City Engineer _____	Date _____
Community Development _____	Date _____

**REVISED 60% REVIEW SUBMITTAL  
NOT FOR CONSTRUCTION**

**Exhibit 16  
SSDP2016-00415  
LANDSCAPE PLAN 001361**

REVISIONS	DATE	BY	DESIGNED
			J. SWENSON
			B. PURGANAN
			P. JOHANNESSEN
			Y. HO

**ONE INCH AT FULL SCALE,  
IF NOT, SCALE ACCORDINGLY**

FILE NAME: BL1521075P19T03LA-03  
JOB No: 554-1521-075 P19 T03  
DATE: JULY 2017

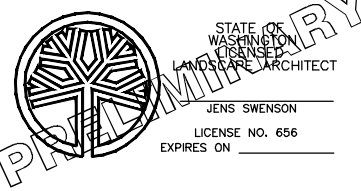

**Parametrix**  
ENGINEERING · PLANNING · ENVIRONMENTAL SCIENCES

719 2ND AVENUE, SUITE 200 | SEATTLE, WA 98104  
P 206.394.3700  
WWW.PARAMETRIX.COM

PROJECT NAME  
**EAST LAKE SAMMAMISH  
MASTER PLAN TRAIL  
SOUTH SAMMAMISH SEGMENT B**  
SAMMAMISH, WA

SHEET NO.  
148 OF 158

**LA14**

PATH: U:\PSO\Projects\Clients\1521-075-ELST-KingCo\554-1521-075-ELST-KingCo\554-1521-075-ELST-KingCo\CADD\Phase 19\_T03\_Civil\DWG\ LAYOUT: LA15 PLOTTED BY: purgaban DATE: Friday, July 07, 2017 3:13:53 PM

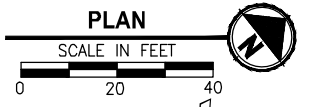
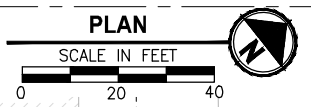
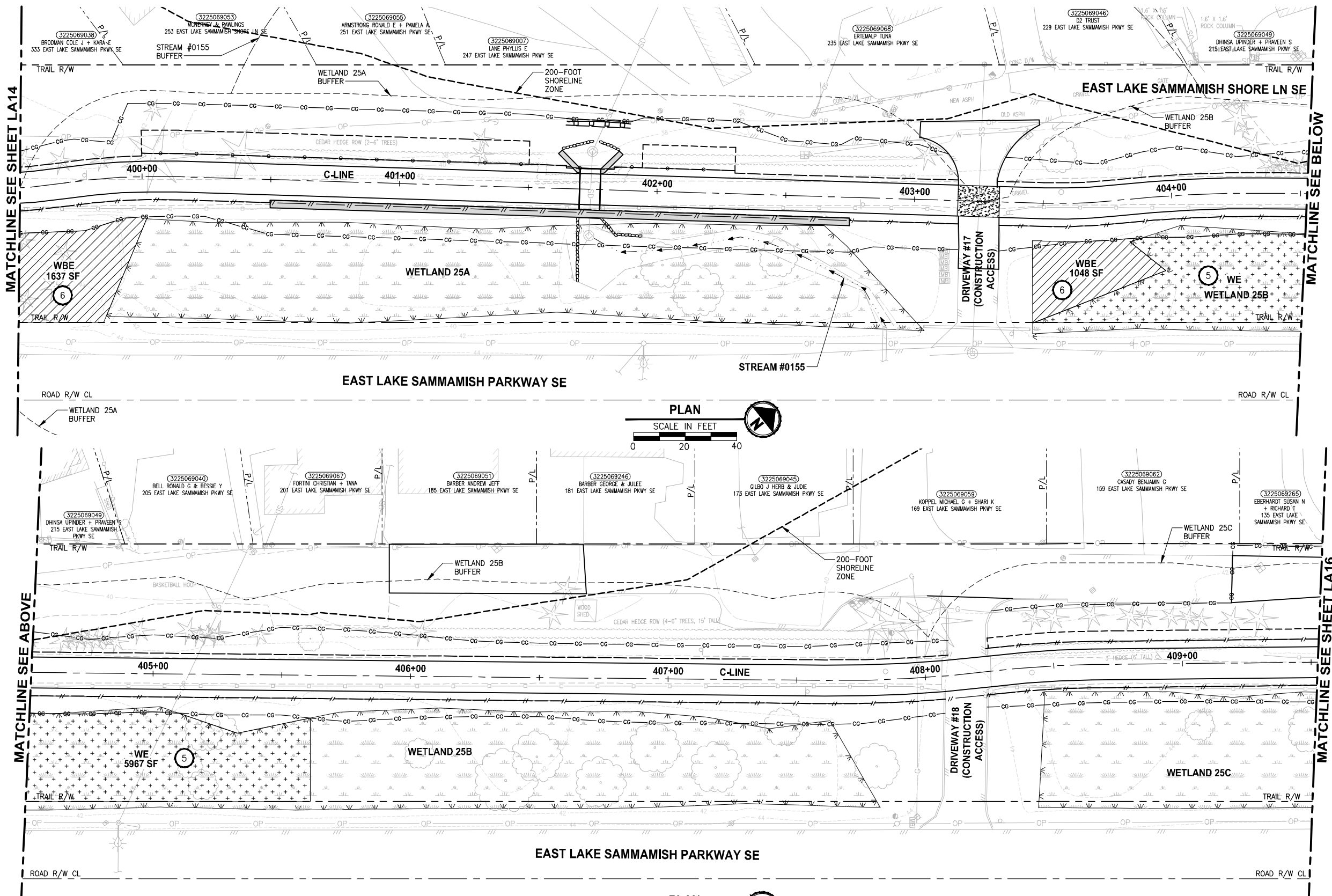

- CONSTRUCTION NOTES:**
- 1 REMOVE LAWN IN THIS AREA.
  - 2 REMOVE CONCRETE PAD.
  - 3 REMOVE GRAVEL PAVING.
  - 4 REMOVE STRUCTURE IN THIS AREA.
  - 5 PROTECT EXISTING NATIVE TREES AND SHRUBS; REMOVE BLACKBERRY AND OTHER UNWANTED INVASIVE PLANTS; AMEND SOIL WITH COMPOST; PLANT WITH NATIVE WETLAND PLANTS AND PLACE WOOD CHIP MULCH OVER ENTIRE AREA.
  - 6 PROTECT EXISTING NATIVE TREES AND SHRUBS; REMOVE BLACKBERRY AND OTHER UNWANTED INVASIVE PLANTS; AMEND SOIL WITH COMPOST; PLANT WITH NATIVE BUFFER PLANTS AND PLACE WOOD CHIP MULCH OVER ENTIRE AREA.
  - 7 GRADE AREA TO CREATE WETLAND CONDITIONS AND AMEND SOIL WITH COMPOST, PLANT WITH NATIVE WETLAND PLANTS.

- GENERAL NOTES:**
1. SEE SHEET LA23 FOR DETAILS AND PLANT LISTS.
  2. SEEDING FOR REMOVED DRIVEWAYS IS NOT PART OF THE MITIGATION PLAN.

- LEGEND:**
- WBE WETLAND BUFFER ENHANCEMENT (6)
  - WBA WETLAND BUFFER ADDITION AREA (6)
  - SSE SHORELINE SETBACK ENHANCEMENT AREA (6)
  - WC/WR WETLAND CREATION OR RESTORATION AREA (7)
  - WE WETLAND ENHANCEMENT AREA (5)
  - SBE STREAM BUFFER ENHANCEMENT AREA (6)
  - SEEDING FOR REMOVED DRIVEWAYS. NOTE 2.

CITY OF SAMMAMISH APPROVAL	
City Engineer _____	Date _____
Community Development _____	Date _____

**REVISED 60% REVIEW SUBMITTAL  
NOT FOR CONSTRUCTION**

**Exhibit 16  
SSDP2016-00415  
LANDSCAPE PLAN 001362**

REVISIONS	DATE	BY	DESIGNED
			J. SWENSON
			B. PURGANAN
			P. JOHANNESSEN
			Y. HO

**ONE INCH AT FULL SCALE,  
IF NOT, SCALE ACCORDINGLY**  
 FILE NAME: BL1521075P19T03LA-03  
 JOB No.: 554-1521-075 P19 T03  
 DATE: JULY 2017

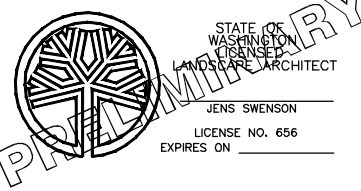

**Parametrix**  
 ENGINEERING · PLANNING · ENVIRONMENTAL SCIENCES  
 719 2ND AVENUE, SUITE 200 | SEATTLE, WA 98104  
 P 206.394.3700  
 WWW.PARAMETRIX.COM

PROJECT NAME:  
**EAST LAKE SAMMAMISH  
 MASTER PLAN TRAIL  
 SOUTH SAMMAMISH SEGMENT B**  
 SAMMAMISH, WA

SHEET NO.  
 149 OF 158  
**LA15**

LAYOUT: LA16  
 PATH: J:\PSO\Projects\Clients\1521-KingCo\554-1521-075-ELST\995\CA\554-1521-075-ELST\CADD\Phase 19\_T03\_Civil\DWG\ PLOTTED BY: pargabul DATE: Friday, July 07, 2017 3:14:22 PM

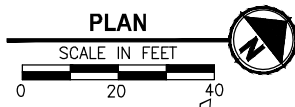
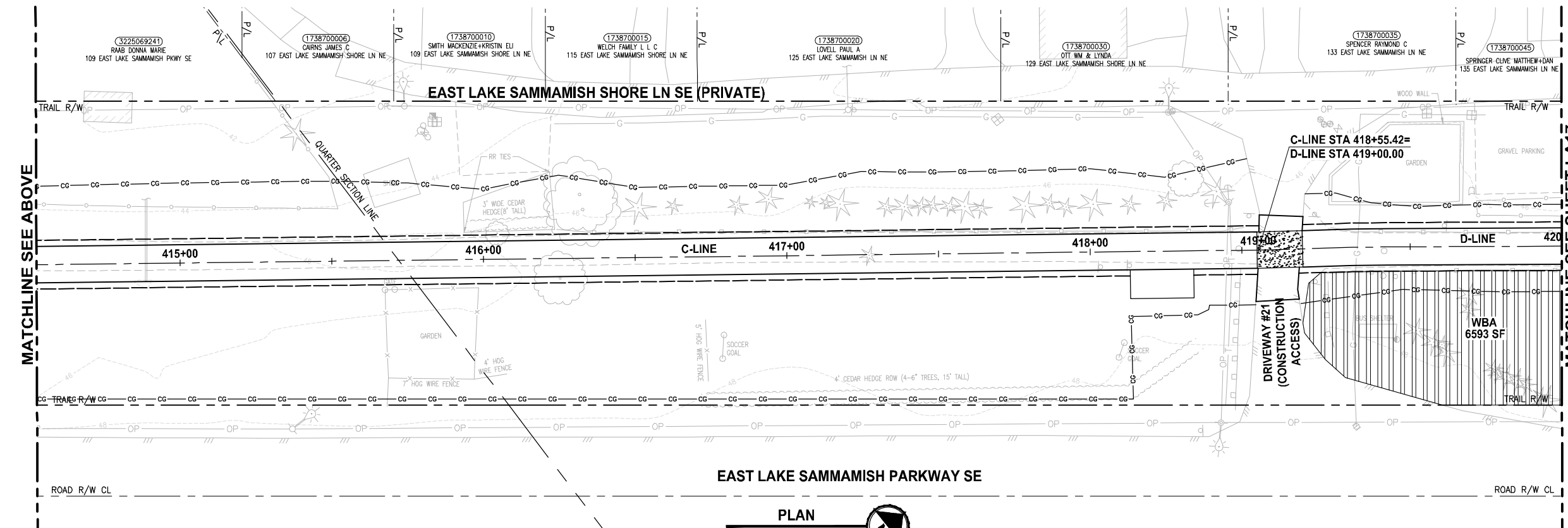
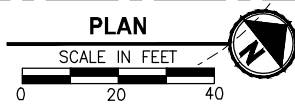
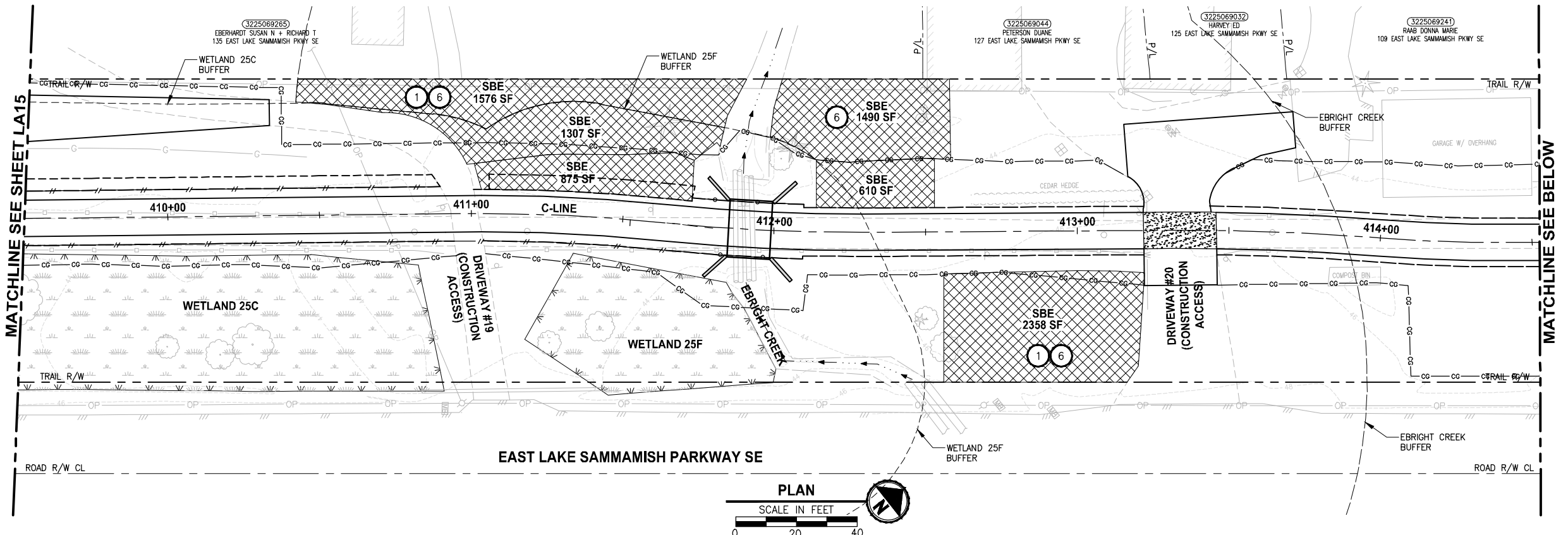

- CONSTRUCTION NOTES:**
- REMOVE LAWN IN THIS AREA.
  - REMOVE CONCRETE PAD.
  - REMOVE GRAVEL PAVING.
  - REMOVE STRUCTURE IN THIS AREA.
  - PROTECT EXISTING NATIVE TREES AND SHRUBS; REMOVE BLACKBERRY AND OTHER UNWANTED INVASIVE PLANTS; AMEND SOIL WITH COMPOST; PLANT WITH NATIVE WETLAND PLANTS AND PLACE WOOD CHIP MULCH OVER ENTIRE AREA.
  - PROTECT EXISTING NATIVE TREES AND SHRUBS; REMOVE BLACKBERRY AND OTHER UNWANTED INVASIVE PLANTS; AMEND SOIL WITH COMPOST; PLANT WITH NATIVE BUFFER PLANTS AND PLACE WOOD CHIP MULCH OVER ENTIRE AREA.
  - GRADE AREA TO CREATE WETLAND CONDITIONS AND AMEND SOIL WITH COMPOST, PLANT WITH NATIVE WETLAND PLANTS.
- GENERAL NOTES:**
- SEE SHEET LA23 FOR DETAILS AND PLANT LISTS.
  - SEEDING FOR REMOVED DRIVEWAYS IS NOT PART OF THE MITIGATION PLAN.
- LEGEND:**
- WBE WETLAND BUFFER ENHANCEMENT (6)
  - WBA WETLAND BUFFER ADDITION AREA (6)
  - SSE SHORELINE SETBACK ENHANCEMENT AREA (6)
  - WC/WR WETLAND CREATION OR RESTORATION AREA (7)
  - WE WETLAND ENHANCEMENT AREA (5)
  - SBE STREAM BUFFER ENHANCEMENT AREA (6)
  - SEEDING FOR REMOVED DRIVEWAYS. NOTE 2.

CITY OF SAMMAMISH APPROVAL	
City Engineer	Date
Community Development	Date

**REVISED 60% REVIEW SUBMITTAL**  
**NOT FOR CONSTRUCTION**

**Exhibit 16**  
**SSDP2016-00415**  
**LANDSCAPE PLAN 001363**

REVISIONS	DATE	BY	DESIGNED
			J. SWENSON
			B. PURGANAN
			P. JOHANNESSEN
			Y. HO

**ONE INCH AT FULL SCALE, IF NOT, SCALE ACCORDINGLY**  
 FILE NAME: BL1521075P19T03LA-03  
 JOB No: 554-1521-075 P19 T03  
 DATE: JULY 2017

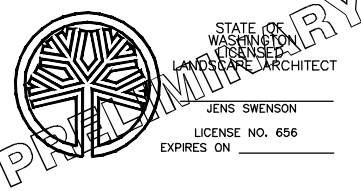

**Parametrix**  
 ENGINEERING · PLANNING · ENVIRONMENTAL SCIENCES  
 719 2ND AVENUE, SUITE 200 | SEATTLE, WA 98104  
 P 206.394.3700  
 WWW.PARAMETRIX.COM

PROJECT NAME  
**EAST LAKE SAMMAMISH MASTER PLAN TRAIL SOUTH SAMMAMISH SEGMENT B**  
 SAMMAMISH, WA

SHEET NO.  
 150 OF 158  
**LA16**





LAYOUT: LA18  
 PATH: J:\PSO\Projects\Clients\1521-075-ELST\995\SSDP\Phase 19\_T03\_Civil\DWG\ PLOTTED BY: purgaban DATE: Friday, July 07, 2017 3:16:31 PM

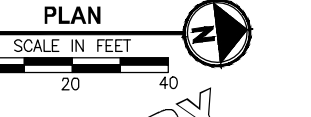
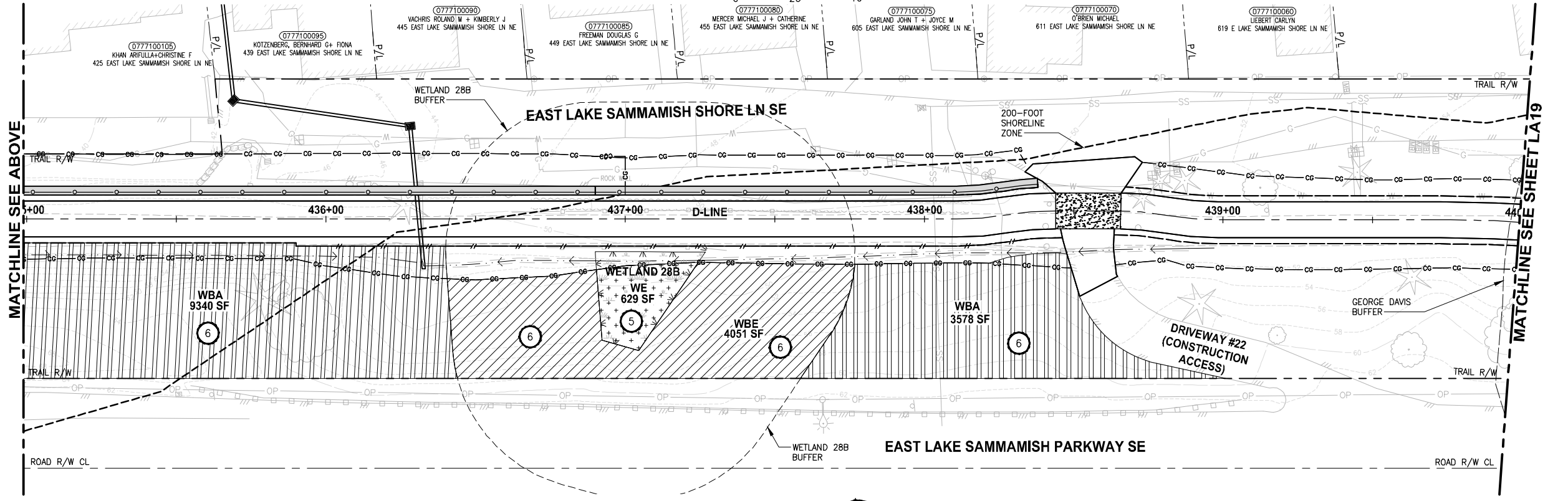
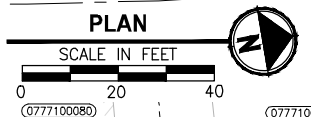
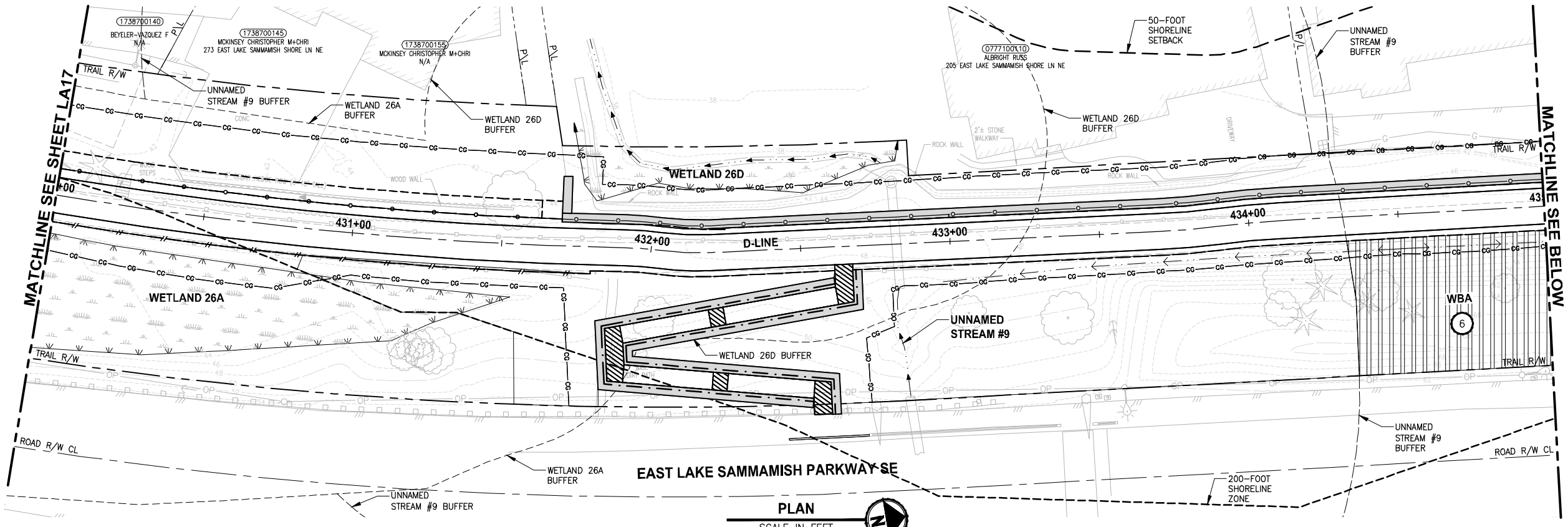

- CONSTRUCTION NOTES:**
- 1 REMOVE LAWN IN THIS AREA.
  - 2 REMOVE CONCRETE PAD.
  - 3 REMOVE GRAVEL PAVING.
  - 4 REMOVE STRUCTURE IN THIS AREA.
  - 5 PROTECT EXISTING NATIVE TREES AND SHRUBS; REMOVE BLACKBERRY AND OTHER UNWANTED INVASIVE PLANTS; AMEND SOIL WITH COMPOST; PLANT WITH NATIVE WETLAND PLANTS AND PLACE WOOD CHIP MULCH OVER ENTIRE AREA.
  - 6 PROTECT EXISTING NATIVE TREES AND SHRUBS; REMOVE BLACKBERRY AND OTHER UNWANTED INVASIVE PLANTS; AMEND SOIL WITH COMPOST; PLANT WITH NATIVE BUFFER PLANTS AND PLACE WOOD CHIP MULCH OVER ENTIRE AREA.
  - 7 GRADE AREA TO CREATE WETLAND CONDITIONS AND AMEND SOIL WITH COMPOST, PLANT WITH NATIVE WETLAND PLANTS.

- GENERAL NOTES:**
1. SEE SHEET LA23 FOR DETAILS AND PLANT LISTS.
  2. SEEDING FOR REMOVED DRIVEWAYS IS NOT PART OF THE MITIGATION PLAN.

- LEGEND:**
- WBE WETLAND BUFFER ENHANCEMENT AREA (6)
  - WBA WETLAND BUFFER ADDITION AREA (6)
  - SSE SHORELINE SETBACK ENHANCEMENT AREA (6)
  - WC/WR WETLAND CREATION OR RESTORATION AREA (7)
  - WE WETLAND ENHANCEMENT AREA (5)
  - SBE STREAM BUFFER ENHANCEMENT AREA (6)
  - SEEDING FOR REMOVED DRIVEWAYS. NOTE 2.

CITY OF SAMMAMISH APPROVAL	
City Engineer _____	Date _____
Community Development _____	Date _____

**REVISED 60% REVIEW SUBMITTAL  
NOT FOR CONSTRUCTION**

**Exhibit 16  
SSDP2016-00415  
LANDSCAPE PLAN 001365**

SHEET NO.  
152 OF 158  
**LA18**

REVISIONS	DATE	BY	DESIGNED
			J. SWENSON
			B. PURGANAN
			P. JOHANNESSEN
			Y. HO

**ONE INCH AT FULL SCALE.  
IF NOT, SCALE ACCORDINGLY**

FILE NAME: BL1521075P19T03LA-04  
 JOB No.: 554-1521-075 P19 T03  
 DATE: JULY 2017

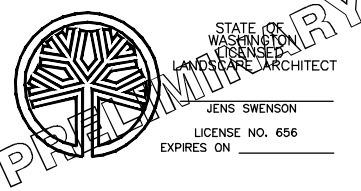

**Parametrix**  
 ENGINEERING · PLANNING · ENVIRONMENTAL SCIENCES

719 2ND AVENUE, SUITE 200 | SEATTLE, WA 98104  
 P 206.394.3700  
 WWW.PARAMETRIX.COM

PROJECT NAME  
**EAST LAKE SAMMAMISH  
 MASTER PLAN TRAIL  
 SOUTH SAMMAMISH SEGMENT B**  
 SAMMAMISH, WA

LAYOUT: LA19  
 PATH: J:\PSO\Projects\Clients\1521-KingCo\554-1521-075-ELST\995\sect\CADD\Phase 19\_T03\_Civil\DWG\ PLOTTED BY: pargobut DATE: Friday, July 07, 2017 3:17:00 PM

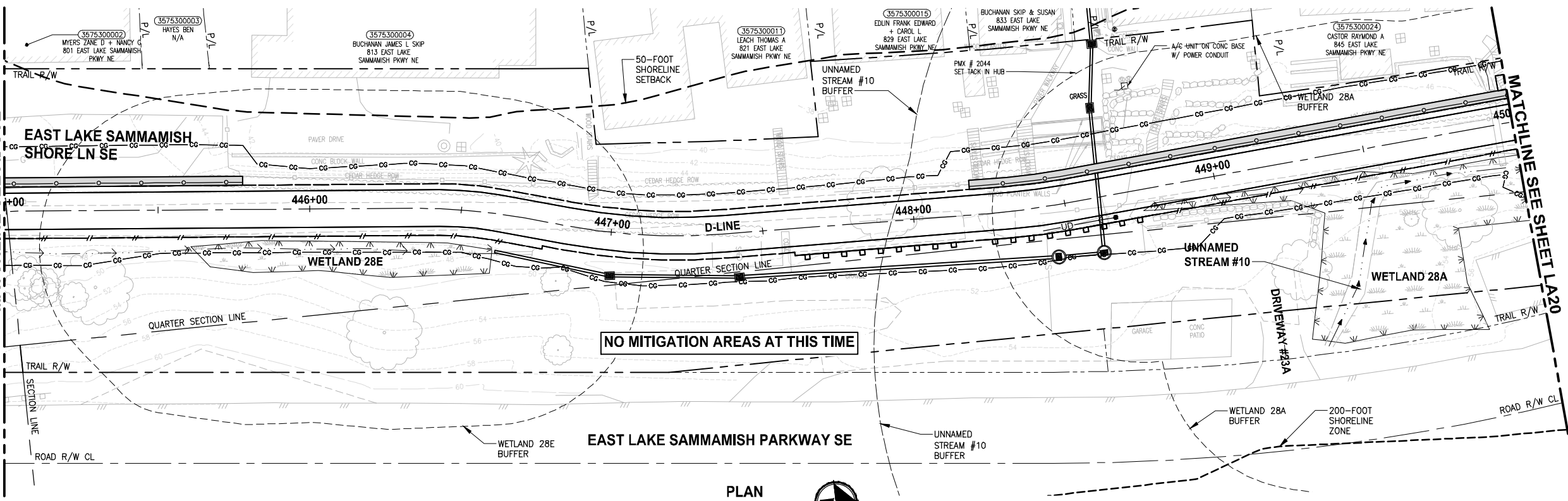
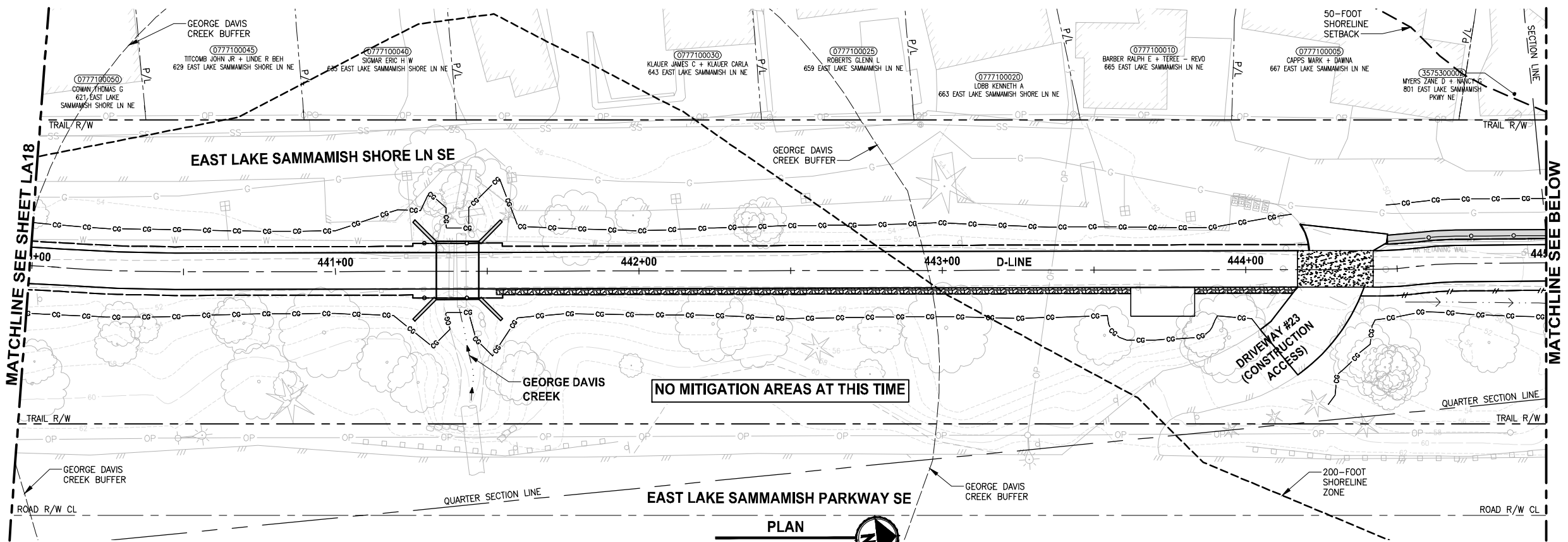

- CONSTRUCTION NOTES:**
- 1 REMOVE LAWN IN THIS AREA.
  - 2 REMOVE CONCRETE PAD.
  - 3 REMOVE GRAVEL PAVING.
  - 4 REMOVE STRUCTURE IN THIS AREA.
  - 5 PROTECT EXISTING NATIVE TREES AND SHRUBS; REMOVE BLACKBERRY AND OTHER UNWANTED INVASIVE PLANTS; AMEND SOIL WITH COMPOST; PLANT WITH NATIVE WETLAND PLANTS AND PLACE WOOD CHIP MULCH OVER ENTIRE AREA.
  - 6 PROTECT EXISTING NATIVE TREES AND SHRUBS; REMOVE BLACKBERRY AND OTHER UNWANTED INVASIVE PLANTS; AMEND SOIL WITH COMPOST; PLANT WITH NATIVE BUFFER PLANTS AND PLACE WOOD CHIP MULCH OVER ENTIRE AREA.
  - 7 GRADE AREA TO CREATE WETLAND CONDITIONS AND AMEND SOIL WITH COMPOST, PLANT WITH NATIVE WETLAND PLANTS.

- GENERAL NOTES:**
1. SEE SHEET LA23 FOR DETAILS AND PLANT LISTS.
  2. SEEDING FOR REMOVED DRIVEWAYS IS NOT PART OF THE MITIGATION PLAN.

**LEGEND:**

	WETLAND BUFFER ENHANCEMENT	6
	WETLAND BUFFER ADDITION AREA	6
	SHORELINE SETBACK ENHANCEMENT AREA	6
	WETLAND CREATION OR RESTORATION AREA	7
	WETLAND ENHANCEMENT AREA	5
	STREAM BUFFER ENHANCEMENT AREA	6
	SEEDING FOR REMOVED DRIVEWAYS. NOTE 2.	

CITY OF SAMMAMISH APPROVAL	
City Engineer _____	Date _____
Community Development _____	Date _____

**REVISED 60% REVIEW SUBMITTAL  
NOT FOR CONSTRUCTION**

REVISIONS	DATE	BY	DESIGNED
			J. SWENSON
			B. PURGANAN
			P. JOHANNESSEN
			Y. HO

ONE INCH AT FULL SCALE, IF NOT, SCALE ACCORDINGLY  
 FILE NAME: BL1521075P19T03LA-04  
 JOB No.: 554-1521-075 P19 T03  
 DATE: JULY 2017

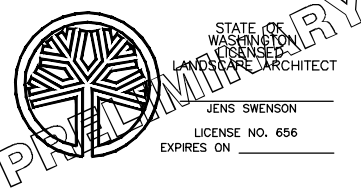

**Parametrix**  
 ENGINEERING · PLANNING · ENVIRONMENTAL SCIENCES  
 739 2ND AVENUE, SUITE 200 | SEATTLE, WA 98104  
 P 206.394.3700  
 WWW.PARAMETRIX.COM

PROJECT NAME  
**EAST LAKE SAMMAMISH  
 MASTER PLAN TRAIL  
 SOUTH SAMMAMISH SEGMENT B**  
 SAMMAMISH, WA

**Exhibit 16  
 SSDP2016-00415  
 LANDSCAPE PLAN 001366**

SHEET NO.  
 153 OF 158  
**LA19**

LAYOUT: LA20  
 PATH: U:\PSO\Projects\Clients\1521-075-ELST\995sec\CA00\Phase 19\T03\_Civil\Draw\ PLOTTED BY: purgaban DATE: Friday, July 07, 2017 3:17:31 PM

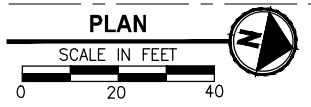
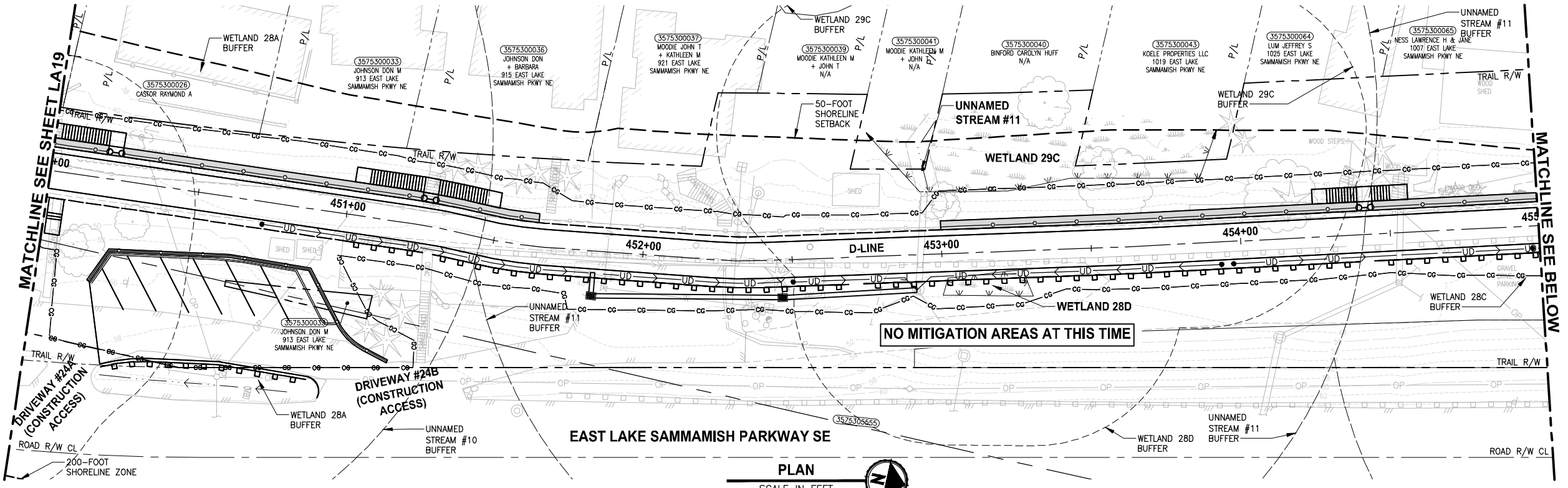

- CONSTRUCTION NOTES:**
- 1 REMOVE LAWN IN THIS AREA.
  - 2 REMOVE CONCRETE PAD.
  - 3 REMOVE GRAVEL PAVING.
  - 4 REMOVE STRUCTURE IN THIS AREA.
  - 5 PROTECT EXISTING NATIVE TREES AND SHRUBS; REMOVE BLACKBERRY AND OTHER UNWANTED INVASIVE PLANTS; AMEND SOIL WITH COMPOST; PLANT WITH NATIVE WETLAND PLANTS AND PLACE WOOD CHIP MULCH OVER ENTIRE AREA.
  - 6 PROTECT EXISTING NATIVE TREES AND SHRUBS; REMOVE BLACKBERRY AND OTHER UNWANTED INVASIVE PLANTS; AMEND SOIL WITH COMPOST; PLANT WITH NATIVE BUFFER PLANTS AND PLACE WOOD CHIP MULCH OVER ENTIRE AREA.
  - 7 GRADE AREA TO CREATE WETLAND CONDITIONS AND AMEND SOIL WITH COMPOST, PLANT WITH NATIVE WETLAND PLANTS.

- GENERAL NOTES:**
1. SEE SHEET LA23 FOR DETAILS AND PLANT LISTS.
  2. SEEDING FOR REMOVED DRIVEWAYS IS NOT PART OF THE MITIGATION PLAN.

- LEGEND:**
- WETLAND BUFFER ENHANCEMENT (6)
  - WETLAND BUFFER ADDITION AREA (6)
  - SHORELINE SETBACK ENHANCEMENT AREA (6)
  - WETLAND CREATION OR RESTORATION AREA (7)
  - WETLAND ENHANCEMENT AREA (5)
  - STREAM BUFFER ENHANCEMENT AREA (6)
  - SEEDING FOR REMOVED DRIVEWAYS. NOTE 2.

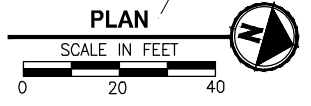
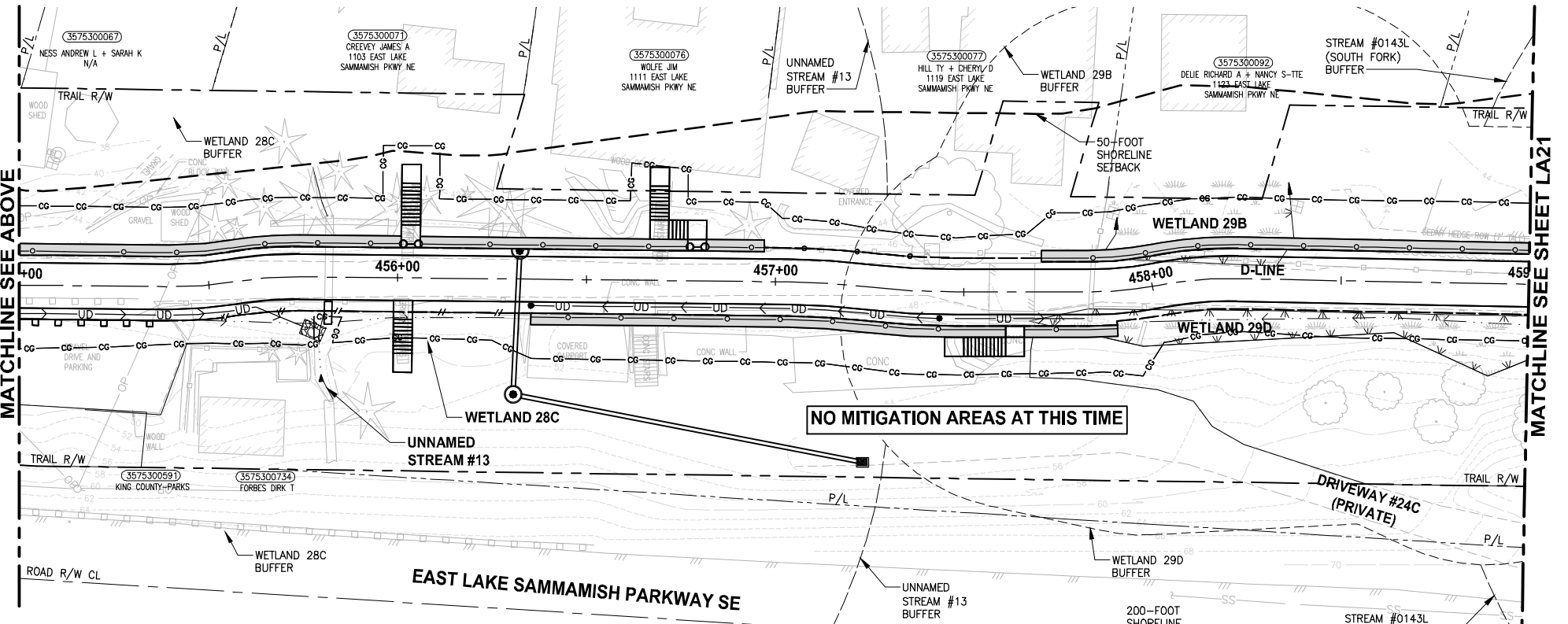

CITY OF SAMMAMISH APPROVAL	
City Engineer _____	Date _____
Community Development _____	Date _____

**REVISED 60% REVIEW SUBMITTAL**  
 NOT FOR CONSTRUCTION

REVISIONS	DATE	BY	DESIGNED
			J. SWENSON
			B. PURGANAN
			P. JOHANNESSEN
			Y. HO

**ONE INCH AT FULL SCALE, IF NOT, SCALE ACCORDINGLY**  
 FILE NAME: BL1521075P19T03LA-04  
 JOB No.: 554-1521-075 P19 T03  
 DATE: JULY 2017

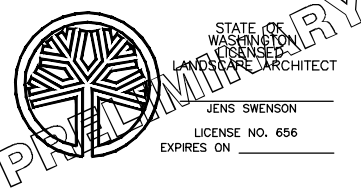

**Parametrix**  
 ENGINEERING · PLANNING · ENVIRONMENTAL SCIENCES  
 719 2ND AVENUE, SUITE 200 | SEATTLE, WA 98104  
 P 206.394.3700  
 WWW.PARAMETRIX.COM

PROJECT NAME:  
**EAST LAKE SAMMAMISH MASTER PLAN TRAIL SOUTH SAMMAMISH SEGMENT B**  
 SAMMAMISH, WA

**Exhibit 16**  
**SSDP2016-00415**  
**LANDSCAPE PLAN 001367**

SHEET NO. 154 OF 158  
**LA20**

PATH: J:\PSO\Projects\Clients\1521-075-ELST-075-ELST\985\CA\ADD\Phase 19\T03\_Civil\DWG\ LAYOUT: LA21 PLOTTED BY: purgaban DATE: Friday, July 07, 2017 3:18:01 PM

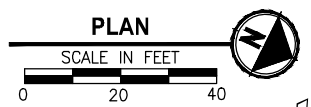
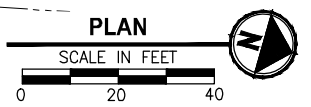
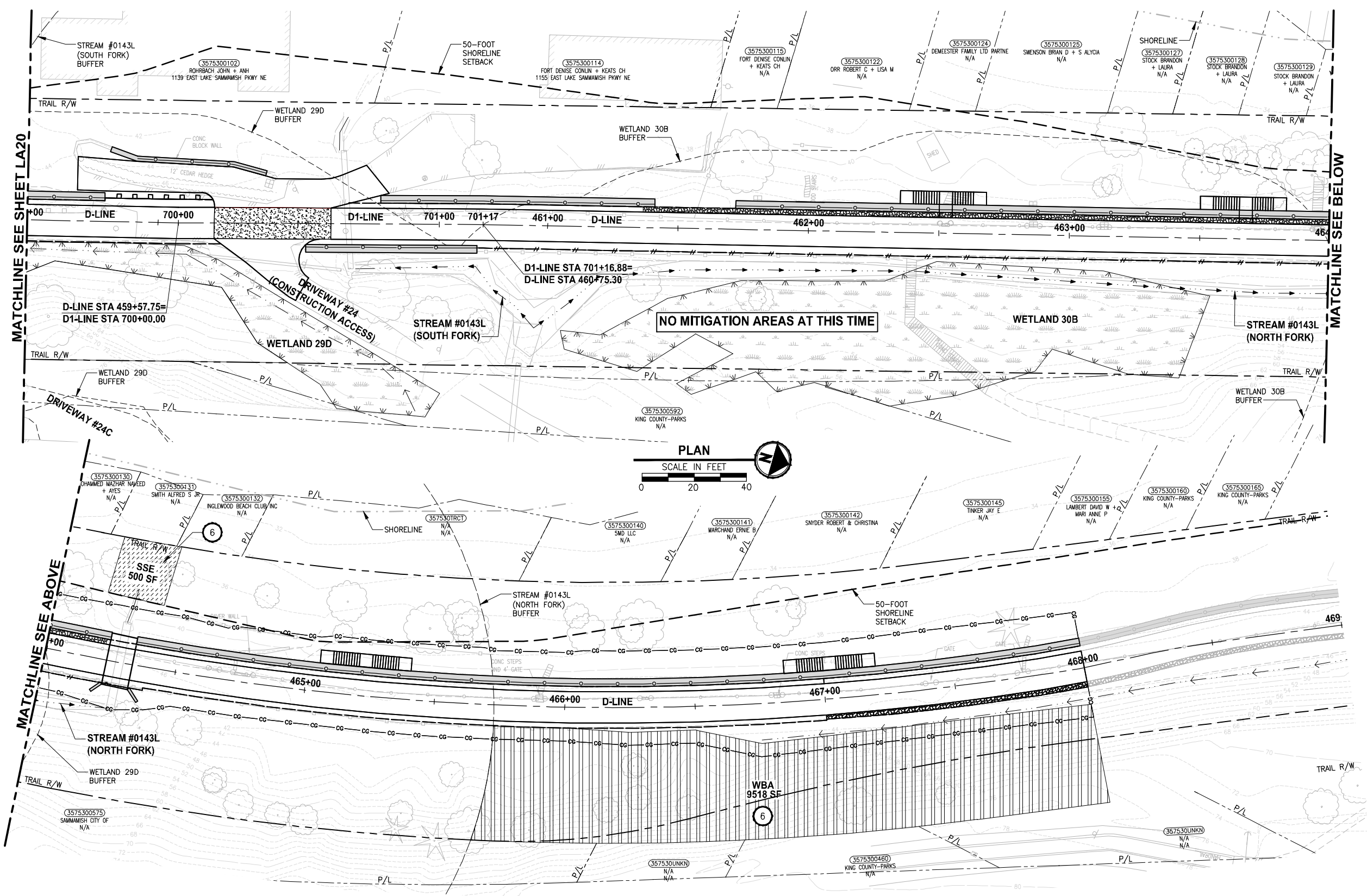

- CONSTRUCTION NOTES:**
- 1 REMOVE LAWN IN THIS AREA.
  - 2 REMOVE CONCRETE PAD.
  - 3 REMOVE GRAVEL PAVING.
  - 4 REMOVE STRUCTURE IN THIS AREA.
  - 5 PROTECT EXISTING NATIVE TREES AND SHRUBS; REMOVE BLACKBERRY AND OTHER UNWANTED INVASIVE PLANTS; AMEND SOIL WITH COMPOST; PLANT WITH NATIVE WETLAND PLANTS AND PLACE WOOD CHIP MULCH OVER ENTIRE AREA.
  - 6 PROTECT EXISTING NATIVE TREES AND SHRUBS; REMOVE BLACKBERRY AND OTHER UNWANTED INVASIVE PLANTS; AMEND SOIL WITH COMPOST; PLANT WITH NATIVE BUFFER PLANTS AND PLACE WOOD CHIP MULCH OVER ENTIRE AREA.
  - 7 GRADE AREA TO CREATE WETLAND CONDITIONS AND AMEND SOIL WITH COMPOST, PLANT WITH NATIVE WETLAND PLANTS.

- GENERAL NOTES:**
1. SEE SHEET LA23 FOR DETAILS AND PLANT LISTS.
  2. SEEDING FOR REMOVED DRIVEWAYS IS NOT PART OF THE MITIGATION PLAN.

- LEGEND:**
- WBE WETLAND BUFFER ENHANCEMENT (6)
  - WBA WETLAND BUFFER ADDITION AREA (6)
  - SSE SHORELINE SETBACK ENHANCEMENT AREA (6)
  - WC/WR WETLAND CREATION OR RESTORATION AREA (7)
  - WE WETLAND ENHANCEMENT AREA (5)
  - SBE STREAM BUFFER ENHANCEMENT AREA (6)
  - Seeding for removed driveways. NOTE 2.

CITY OF SAMMAMISH APPROVAL

City Engineer	Date
Community Development	Date

REVISED 60% REVIEW SUBMITTAL  
NOT FOR CONSTRUCTION

Exhibit 16  
SSDP2016-00415  
LANDSCAPE PLAN 001368

SHEET NO.  
155 OF 158  
LA21

REVISIONS	DATE	BY	DESIGNED
			J. SWENSON
			B. PURGANAN
			P. JOHANNESSEN
			Y. HO

ONE INCH AT FULL SCALE.  
IF NOT, SCALE ACCORDINGLY

FILE NAME  
BL1521075P19T03LA-04

JOB No.  
54-1521-075 P19 T03

DATE  
JULY 2017

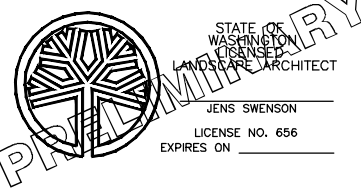

**Parametrix**  
ENGINEERING · PLANNING · ENVIRONMENTAL SCIENCES

719 2ND AVENUE, SUITE 200 | SEATTLE, WA 98104  
P 206.394.3700  
WWW.PARAMETRIX.COM

PROJECT NAME  
**EAST LAKE SAMMAMISH  
MASTER PLAN TRAIL  
SOUTH SAMMAMISH SEGMENT B**  
SAMMAMISH, WA

PATH: U:\P50\Projects\Clients\1521-1521-075-ELST\995sec\CaDD\Phase 19\T03\_Cha\Draw\ LAYOUT: LA22 PLOTTED BY: purgabut DATE: Friday, July 07, 2017 3:18:13 PM

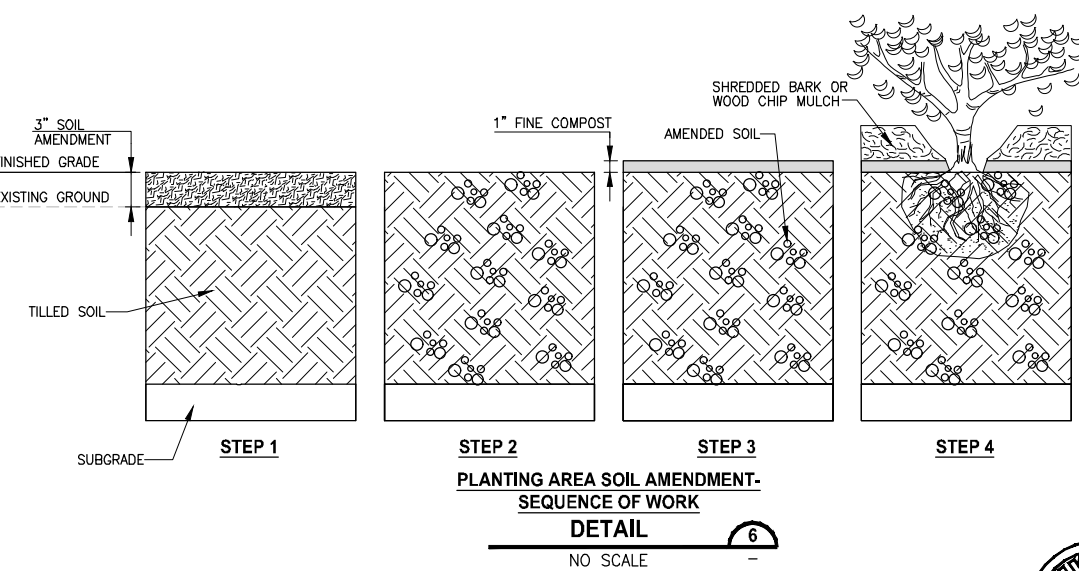
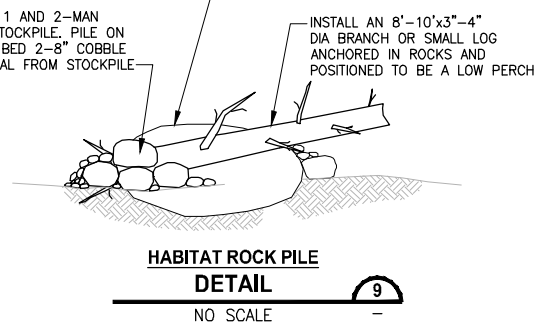
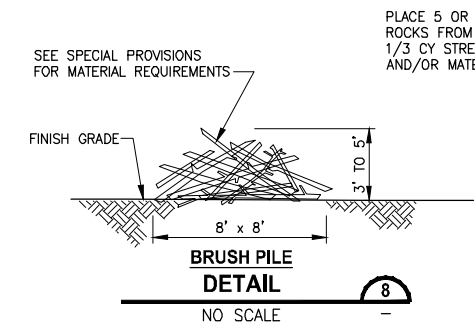
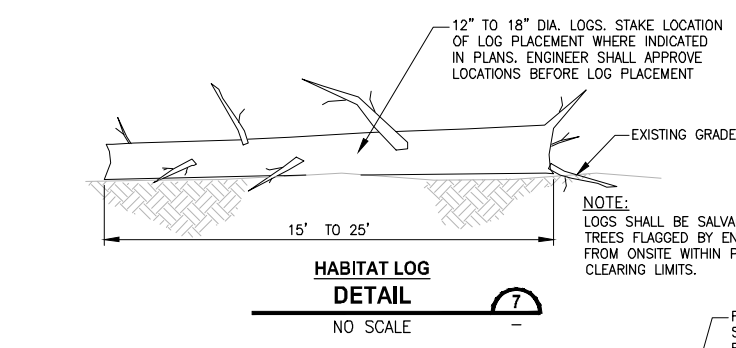
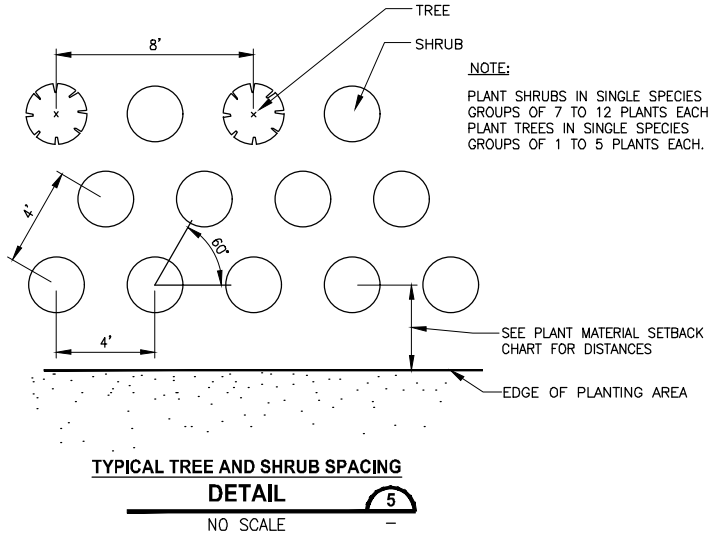
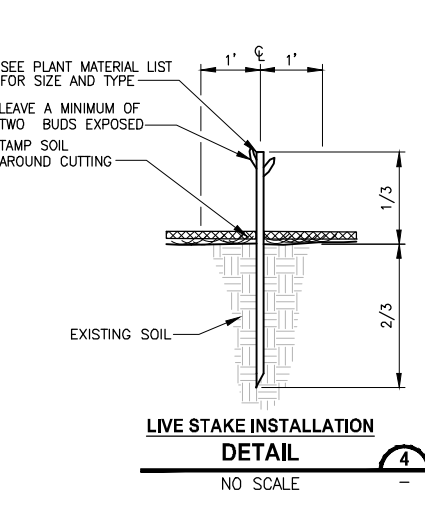
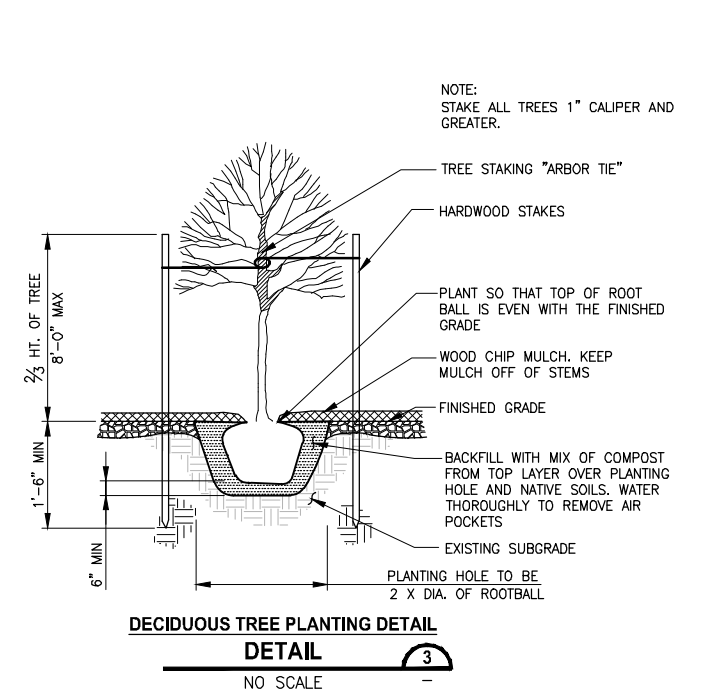
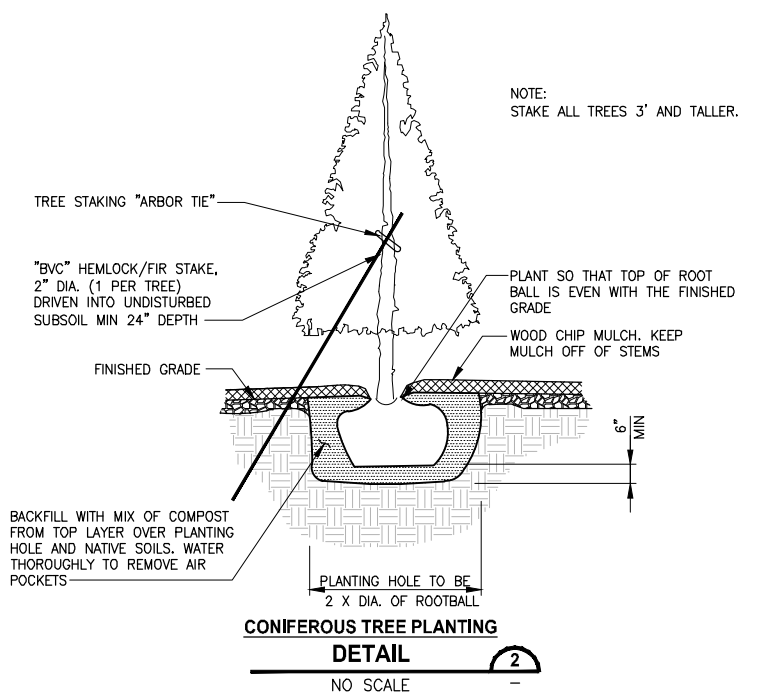
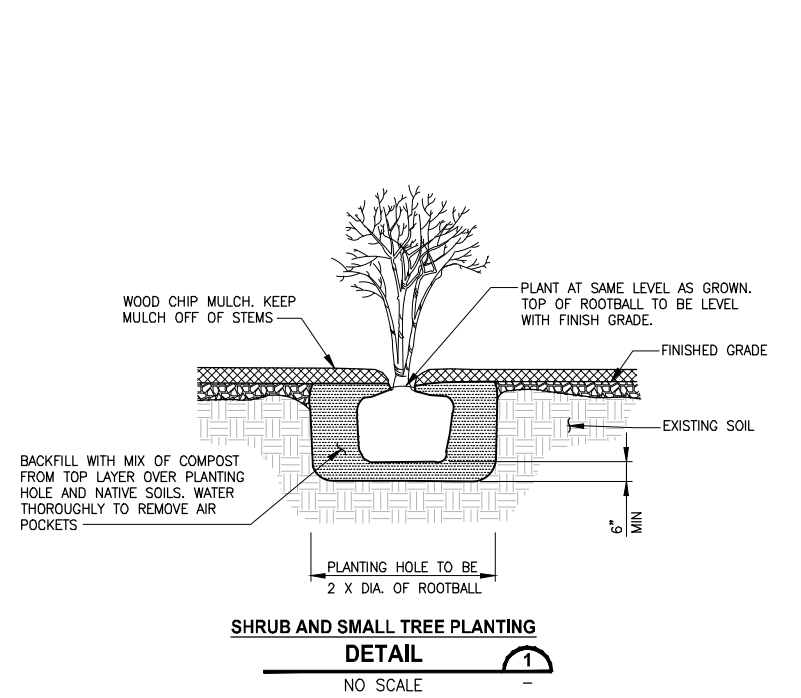

- STEP 1**  
TILL, DISC OR RIP SOIL IN PLANTING AREAS TO 10" DEPTH. PLACE 3" OF SOIL AMENDMENT OVER SOIL SURFACE.
- STEP 2**  
TILL SOIL AMENDMENT INTO TOP 10" OF ENTIRE PLANTING ZONES NATIVE SOIL AFTER CLEARING AND GRUBBING.
- STEP 3**  
INSTALL 1" FINE COMPOST OVER PLANTING AREA WHERE CALLED FOR IN PLANS.
- STEP 4**  
INSTALL PLANTS FOLLOWED BY 3" WOOD CHIP MULCH.

**PLANT MATERIAL SETBACK CHART**

	GUARDRAIL BARRIER	EDGE OF ROADWAY	PATHS, TRAILS	WALL	FENCE	SIGNS	EXISTING TREE, TRUNK	EXISTING VEGETATION MASS
EVERGREEN TREE	15'	15'	10'	8'	8'	15'	10'	-
ORNAMENTAL/NATIVE DECIDUOUS TREE	6'	6'	10'	8'	8'	15'	10'	-
MEDIUM AND LARGE SHRUBS - GREATER THAN 3' TALL	5'	5'	8'	3'	3'	6'	5'	5'
SMALL SHRUB - LESS THAN 3' TALL	3'	5'	5'	2'	3'	2'	5'	5'

TYPICAL MINIMUM DISTANCE SETBACKS ARE TO THE CENTER STEM OR TRUNK OF PLANT MATERIAL UNLESS OTHERWISE DIRECTED BY THE ENGINEER DURING LAYOUT AND STAKING OF PLANT LOCATIONS.

PLANT MATERIAL LIST			
PLANTING AREA MASTER PLANT LISTS			
COMMON NAME	BOTANICAL NAME	NOTES	
<b>TREES</b>			
AMELANCHIER ALNIFOLIA	WESTERN SERVICEBERRY	SPACE TREES 8 TO 10- FEET ON CENTER	
ACER MACROPHYLLUM	BIG LEAF MAPLE		
PICEA SITCHENSIS	SITKA SPRUCE		
PRUNUS EMARGINATA	BITTER CHERRY		
PSUEDOTSGA MENZIESII	DOUGLAS FIR		
THUJA PLICATA	WESTERN RED CEDAR		
TSUGA HETEROPHYLLA	WESTERN HEMLOCK		
<b>SHRUBS</b>			
ACER CIRCINATUM	VINE MAPLE		SPACE SHRUBS 4 TO 6- FEET ON CENTER
CORYLUS CORNUTA	WESTERN HAZEL		
HOLODISCUS DISCOLOR	OCEAN SPRAY		
OEMLARIA CERASIFORMIS	INDIAN PLUMB		
PHYSOCARPUS CAPITATUS	PACIFIC NINEBARK		
ROSA NUTKANA	NOOTKA ROSE		
SYMPHORICARPOS ALBUS	SNOWBERRY		
<b>WETLAND ENHANCEMENT PLANTING AREAS (AREA WE)</b>			
<b>TREES</b>			
FRAXINUS LATIFOLIA	OREGON ASH	SPACE TREES 8 TO 10- FEET ON CENTER	
PICEA SITCHENSIS	SITKA SPRUCE		
SALIX L. SSP. LASIANDRA	PACIFIC WILLOW		
SALIX SCOULERIANA	SCOULEERS WILLOW		
THUJA PLICATA	WESTERN RED CEDAR		
<b>SHRUBS</b>			
CORNUS ALBA	RED-TWIG DOGWOOD		SPACE SHRUBS 4 TO 6- FEET ON CENTER
LONICERA INVOLUCRATA	BLACK TWINBERRY		
MALUS FUSCA	PACIFIC CRAB APPLE		
PHYSOCARPUS CAPITATUS	PACIFIC NINEBARK		
ROSA PISOCARPA	CLUSTERED ROSE		
SALIX SITCHENSIS	SITKA WILLOW		
<b>STREAM BUFFER ENHANCEMENT PLANTING AREAS (AREA SBE)</b>			
<b>TREES</b>			
PICEA SITCHENSIS	SITKA SPRUCE	SPACE TREES 8 TO 10- FEET ON CENTER	
SALIX L. SSP. LASIANDRA	PACIFIC WILLOW		
SALIX SCOULERIANA	SCOULEERS WILLOW		
THUJA PLICATA	WESTERN RED CEDAR		
<b>SHRUBS</b>			
ACER CIRCINATUM	VINE MAPLE		SPACE SHRUBS 4 TO 6- FEET ON CENTER
CORNUS ALBA	RED-TWIG DOGWOOD		
LONICERA INVOLUCRATA	BLACK TWINBERRY		
PHYSOCARPUS CAPITATUS	PACIFIC NINEBARK		
SALIX SITCHENSIS	SITKA WILLOW		
SYMPHORICARPOS ALBUS	SNOWBERRY		

CITY OF SAMMAMISH APPROVAL

City Engineer \_\_\_\_\_ Date \_\_\_\_\_

Community Development \_\_\_\_\_ Date \_\_\_\_\_

**REVISED 60% REVIEW SUBMITTAL**  
NOT FOR CONSTRUCTION

REVISIONS	DATE	BY	DESIGNED	DRAWN	CHECKED	APPROVED
			J. SWENSON	B. PURGANAN	P. JOHANNESSEN	Y. HO

ONE INCH AT FULL SCALE, IF NOT, SCALE ACCORDINGLY

FILE NAME: BL1521075P19T03LA-05

JOB No: 54-1521-075 P19 T03

DATE: JULY 2017

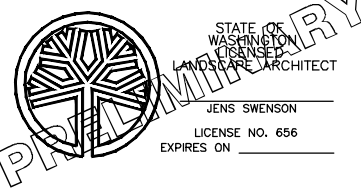

**Parametrix**  
ENGINEERING, PLANNING, ENVIRONMENTAL SCIENCES

719 2ND AVENUE, SUITE 200 | SEATTLE, WA 98104  
P 206.394.3700  
WWW.PARAMETRIX.COM

PROJECT NAME  
**EAST LAKE SAMMAMISH MASTER PLAN TRAIL SOUTH SAMMAMISH SEGMENT B**  
SAMMAMISH, WA

**MITIGATION PLANTING DETAIL**

Exhibit 16  
SSDP2016-00415  
04/13/19

SHEET NO.  
156 OF 158

**LA22**

PATH: U:\PSO\Projects\Clients\1521-KingCo\554-1521-075-ELST\995vec\CAADD\Phase 19\T03\_Civil\Draw\ PLOTTED BY: purgubut DATE: Friday, July 07, 2017 3:18:22 PM LAYOUT: LA23

### Mitigation Goals, Objectives, and Performance Standards

The overall goal of the mitigation effort is to replace the habitats and functions lost as a result of the project. The proposed mitigation will accomplish this by enhancing 0.65 acre of wetland, increasing the buffer of 8 wetlands by 1.53 acres, enhancing 0.75 acre of wetland buffer, enhancing 0.24 acre of stream buffer, replacing 8 fish barrier culverts on 6 Type F streams with pipes that are fish passable, and enhancing 0.09 acre of shoreline setback. In addition, mitigation for 0.22 acre of permanent wetland impacts will occur at an off-site approved mitigation bank, and thus, this mitigation will not be carried forward in the following sections. Specific goals and objectives formulated to achieve this result are presented below.

#### Mitigation Goals

The mitigation goals are:

- Enhance 0.65 acre of wetland.
- Increase and enhance the buffer of 8 wetlands by 1.53 acres.
- Enhance 0.75 acre of wetland buffer.
- Enhance 0.24 acre of stream buffer.
- Replace 8 fish barrier culverts on 6 Type F streams with fish passable culverts.
- Enhance 0.09 acre of shoreline setback.

Achievement of these goals is expected to provide the following improvements to wetland, stream, wetland buffer, stream buffer, and shoreline setback functions:

- Provide additional fish habitat by removing fish barriers, increasing open stream channel, and opening up available upstream habitat.
- Increase the production of organic matter by planting trees and shrubs in the created/restored wetland, enhanced wetland, increased wetland buffer, enhanced wetland buffer, enhanced stream buffer, and enhanced shoreline setback.
- Increase fish and wildlife habitat and improve biological diversity by planting with a variety of native wetland and buffer plant species and installing habitat features (habitat logs and brush piles).

#### Mitigation Objectives and Performance Standards

##### Wetlands

**Objective 1: Enhance by planting native species a minimum of 0.65-acre forested and scrub-shrub wetland at the enhanced wetland areas.**

**Performance Standards:**

- Year 1 Survival of planted woody species in enhanced wetland areas will be at least 80 percent.
- Year 2 Record percent cover of native woody species in enhanced wetland area to establish a baseline for areal cover.

- Year 3 Native woody species will achieve a minimum of 25 percent areal cover, including desirable native volunteers, in the enhanced wetland areas.
- Year 5 Native woody species will achieve a minimum of 50 percent areal cover, including desirable native volunteers, in the enhanced wetland areas.
- Year 7 Native woody species will achieve a minimum of 70 percent areal cover in the enhanced wetland areas.
- Year 10 Native woody species will achieve a minimum of 80 percent areal cover in the enhanced wetland area.

##### Streams

###### Instream Habitat

**Objective 2: Replace existing fish barrier culvert at the (six) trail crossings on Pine Lake Creek, Stream 0155, Ebright Creek, Zackuse Creek, George Davis Creek, Stream 0143L, and (two) downstream road crossings on Pine Lake Creek and Zackuse Creek with fish passage culvert to open up available upstream habitat.**

**Performance Standards:**

- Year 1, 2, 3, and 5 Constructed habitat elements including the new fish passable culverts, regraded channels, and streambed material will remain in place as constructed at all 8 culvert replacement sites.

##### Wetland and Stream Buffers Areas

**Objective 3: Establish a minimum of 2.28-acre forested and scrub-shrub wetland buffer, and 0.24-acre forested stream buffer at the increased/enhanced wetland buffer and enhanced stream buffer areas.**

**Performance Standards:**

- Year 1 Survival of planted woody species in increased/enhanced wetland buffer and enhanced stream buffer areas will be at least 80 percent.
- Year 2 Record percent cover of native woody species in increased/enhanced wetland buffer and enhanced stream buffer areas to establish a baseline for areal cover.
- Year 3 Native woody species will achieve a minimum of 25 percent areal cover in the increased/enhanced wetland buffer and enhanced stream buffer areas.
- Year 5 Native woody species will achieve a minimum of 50 percent areal cover in the increased/enhanced wetland buffer and enhanced stream buffer setback areas.
- Year 7 Native woody species will achieve a minimum of 70 percent areal cover in the increased/enhanced wetland buffer and enhanced stream buffer areas.
- Year 10 Native woody species will achieve a minimum of 80 percent areal cover in the increased/enhanced wetland buffer and enhanced stream buffer areas.

##### Shoreline Setback Areas

**Objective 3: Establish a minimum of 0.09-acre forested habitat at the shoreline setback areas.**

**Performance Standards:**

- Year 1 Survival of planted woody species in enhanced shoreline setback areas will be at least 80 percent.
- Year 2 Record percent cover of native woody species in enhanced shoreline setback areas to establish a baseline for areal cover.
- Year 3 Native woody species will achieve a minimum of 25 percent areal cover in enhanced shoreline setback areas.
- Year 5 Native woody species will achieve a minimum of 50 percent areal cover in enhanced shoreline setback areas.
- Year 7 Native woody species will achieve a minimum of 70 percent areal cover in enhanced shoreline setback areas.
- Year 10 Native woody species will achieve a minimum of 80 percent areal cover in enhanced shoreline setback areas.

##### Invasive Species

**Objective 4: Limit invasive non-native species throughout the mitigation site planting areas.**

**Performance Standards:**

- Year 1, 2, 3, 5, 7, and 10 Himalayan blackberry, cutleaf blackberry, Scotch broom, English ivy, reed canarygrass, and hedge false bindweed will not exceed 20 percent areal cover in all planting areas.
- Year 3 100 percent removal of Japanese knotweed by Year 3 in the Wetland 22CD buffer enhancement area.

##### Wildlife Habitat

**Objective 5: Provide wildlife habitat.**

**Performance Standards:**

- Year 1, 2, 3, 5, 7, and 10 Increase in areal cover of native woody species in all mitigation areas, as measured in Objectives 1, 2, and 3, to be used as a surrogate to indicate increasing habitat functions.
- Year 1, 3, 5, 7, and 10 Increase in species richness of native species over preexisting conditions in all mitigation areas, as measured in Objectives 1, 2, and 3, to be used as a surrogate to indicate increased habitat functions.
- Year 1, 2, 3, 5, 7, and 10 Installed habitat features are present and functional.

##### Anthropogenic Disturbance

**Objective 6: Protect the mitigation sites from anthropogenic disturbance.**

CITY OF SAMMAMISH APPROVAL	
City Engineer _____	Date _____
Community Development _____	Date _____

**REVISED 60 % REVIEW SUBMITTAL  
NOT FOR CONSTRUCTION**

**Exhibit 16  
SSDP2016-00415  
MITIGATION NOTES 001370**

SHEET NO.  
157 OF 158

**LA23**

REVISIONS	DATE	BY	DESIGNED
			J. SWENSON
			B. PURGANAN
			P. JOHANNESSEN
			Y. HO

**ONE INCH AT FULL SCALE.  
IF NOT, SCALE ACCORDINGLY**

FILE NAME  
BL1521075P19T03LA-05

JOB No.  
554-1521-075 P19 T03

DATE  
JULY 2017

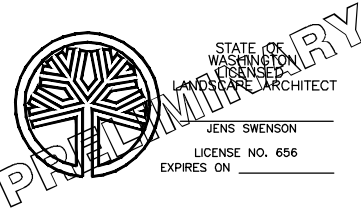

**Parametrix**  
ENGINEERING · PLANNING · ENVIRONMENTAL SCIENCES

719 2ND AVENUE, SUITE 200 | SEATTLE, WA 98104  
P 206.394.3700  
WWW.PARAMETRIX.COM

PROJECT NAME  
**EAST LAKE SAMMAMISH  
MASTER PLAN TRAIL  
SOUTH SAMMAMISH SEGMENT B**  
SAMMAMISH, WA

PATH: U:\PSO\Projects\Clients\1521-KingCo\554-1521-075-ELST\9595ec\CaAD\Phase 19\T03\_Cha\Draw\ PLOTTED BY: purgubut DATE: Friday, July 07, 2017 3:18:27 PM LAYOUT: LA24

**Performance Standards:**

- Year 1 through 10 Conduct qualitative monitoring to assess the status of the sites yearly during the 10-year monitoring period to monitor for human disturbance, including but not limited to filling, trash, and vandalism.
- Year 1 through 10 Install and maintain fences and appropriate signs along the trail adjacent to each site to identify their protected status.

**Record Drawings**

Record drawings and/or a report documenting the as-built or installed conditions will be prepared after construction and plantings are complete. The report will include the following components: (1) drawings that clearly identify the boundaries of the mitigation areas; (2) locations of the sampling and monitoring sites (including photo-point locations); (3) locations of hydrology monitoring stations; (4) photographs of the mitigation sites; and (5) an analysis of any changes to the mitigation plan that occurred during construction. A copy of the as-built report will be sent to the City and USACE within 60 days of completion of construction and planting.

**Monitoring**

The mitigation areas will be monitored during and after construction. During construction, monitoring will ensure that the BMPs are observed to minimize impacts, and the on-site construction work (including grading and planting) will be coordinated to ensure that the sites are constructed as designed.

After construction is completed, long-term monitoring will be performed annually to ensure that the goals and objectives of the mitigation are being met. Monitoring of the mitigation areas will be performed over a 10-year period by a qualified professional (SMC 21A.50.145; 21A.50.300). A combination of quantitative and qualitative monitoring activities will be used to assess the management objectives and associated performance standards described in the mitigation plan. Activities will include site visits to monitor unnatural site disturbance, photographs to document site development, and data collection for the quantitative evaluation of performance standards. The results of the monitoring will be submitted to the permitting agencies.

Appropriate contingency measures will be developed, as needed, by a qualified professional to ensure that the sites develop healthy vegetation that meets the obligations described in this mitigation plan and the associated permits.

**Quantitative Monitoring**

The following bulleted items describe the methods to be used for the quantitative monitoring, monitoring schedule, and report deadlines.

- The planting sites will be assessed by an appropriate quantitative vegetative field assessment methodology. The line intercept method will be used for determining percent areal cover for woody and invasive species. Plant richness will be determined by a count of native tree and shrub species.
- Quantitative vegetation assessments will follow the same method in each consecutive monitoring year.

- Quantitative vegetation assessments will be performed between June 15 and September 15 of each monitoring year.
- Monitoring reports will be sent to agencies requiring monitoring reports by February 15 of the following year.
- Permanent photographic stations will be established to monitor the development of the sites. Photographs will be taken along transect lines and from vantage points that capture the general mitigation area. All photographs will be labeled to identify locations.

**Qualitative Monitoring**

Qualitative monitoring will be conducted as follows:

- A qualified professional will qualitatively assess the constructed habitat elements including the new fish passable culverts, regraded channels, and streambed material for the first 3 years.
- Qualitative assessment will be performed yearly to visually assess the health of plants and identify areas that may need control of non-native invasive species or other maintenance activities.
- During all qualitative monitoring years, photographic documentation of the sites will occur from permanent photograph stations.

**Maintenance**

The proposed mitigation is intended to achieve the performance standards with minimal ongoing maintenance. However, King County will manage and maintain the site for 10 years, or until all performance standards are met and the site is closed with the approval of permitting agencies.

As mentioned previously, King County Parks has a formal maintenance program for its trail mitigation projects. The County understands that regular maintenance is necessary to achieve its mitigation commitments in public trail corridors.

Planted vegetation species are adapted to varying site conditions in the Puget Sound lowland, although supplemental irrigation may be needed during the first two growing seasons after installation to ensure the long-term survival of the plants. The need for irrigation will be evaluated based on the conditions observed during the establishment period.

To ensure rapid establishment of the plant community, trees and shrubs will be planted closer together than would generally occur in natural mature stands. Some natural mortality is expected to occur during the monitoring period. All dead and downed woody material will be left in place to provide microhabitats for wildlife. Plants will be replaced as needed to meet performance standards.

Maintenance to control nuisance species in the mitigation areas will likely be necessary. During the monitoring period, if it becomes evident that invasive species are impeding establishment of desirable native plants, measures will be implemented to control nuisance species. A progressively aggressive approach will be used to control nuisance species. Control measures will first include hand cutting and/or grubbing and removal; if this fails, an environmentally sensitive herbicide (e.g., Rodeo or equivalent) may be applied.

**Contingency Measures**

Adaptive management is driven by the monitoring results and the performance standards. If the performance standards are not met, adaptive management activities will be implemented to achieve the desired condition. Management activities may include implementation of contingencies described in Table 5-5, or other appropriate measures. Site conditions will be evaluated to determine the cause of the problem and the most appropriate countermeasure.

Information from the annual monitoring program will be used to identify any maintenance and/or corrective actions. If problems are identified in monitoring, King County biologists will determine the cause of the problem and implement proper maintenance or corrective activities. These activities will be discussed in the annual monitoring report.

**Performance Security/Financial Assurance**

This mitigation project will be sponsored by King County. The County will implement a suitable mechanism to ensure that the project is implemented successfully and monitored for a minimum of 10 years, or until the project mitigation is deemed a success by achieving its performance standards.

**Site Protection**

The County owns the property underlying the mitigation sites. They will protect the mitigation sites in perpetuity through a legal mechanism that permits maintenance and monitoring of the mitigation area. This mechanism shall be retained by the County and may be submitted to the USACE after permit issuance, if required. In addition, permanent fencing and/or signs indicating that the area is a natural or sensitive or critical area to be protected from disturbance will be posted along the boundaries of each mitigation area.

**Table 5-5. Contingency Measures for the Mitigation Sites**

Problem	Contingency Measure
Less than 80% of planted woody species survive in Year 1	King County biologists (or other qualified biologist) will assess the sites to determine what conditions are preventing the plants from thriving. Appropriate measures will be taken to correct any conditions that are limiting growth. Plants will be replaced with appropriate native species to achieve the Year 1 standard. Additional measures (such as providing additional protection) will be considered if necessary.
Percent cover for woody species not met during Years 3, 5, or 7	King County biologists (or other qualified biologist) will assess the sites to determine what conditions are preventing the plants from thriving. Appropriate measures, such as increased weed control or extra plantings, will be taken to correct any conditions that are limiting growth.
Invasive species exceed percent cover threshold	Implement/revise invasive species control plan.
Performance standards not met at Year 10	Continue the monitoring regime for 1 additional year. The sites will continue to be evaluated every year until each site has met the stated performance standards associated with management objectives. Other contingency measures may be implemented during this period.

**Long-term Management Plan**

The mitigation sites are located on King County property. After attainment of performance standards and acceptance of the mitigation project by the USACE, the County will implement a long-term management plan for the sites as part of trail operations, if required.

Site management activities will include noxious weed control, damage repair from vandalism, trash removal, and signage maintenance.

Monitoring reports or technical memoranda will document annual management activities and identify key issues and actions needed for the following year. Reports are anticipated to be submitted every year to the USACE, by the end of the calendar year, for the first 10 years following attainment of performance standards.

The County will issue a letter of assurance to cover long-term management costs of the mitigation site to the USACE ensuring the County's compliance with the long-term management plan.

CITY OF SAMMAMISH APPROVAL	
City Engineer _____	Date _____
Community Development _____	Date _____

**REVISED 60 % REVIEW SUBMITTAL**  
**NOT FOR CONSTRUCTION**  
Exhibit 16  
SSDP2016-00415  
**MITIGATION NOTES 001371**  
SHEET NO. 158 OF 158  
LA24

REVISIONS	DATE	BY	DESIGNED
			S. SWENSON
			DRAWN B. PURGANAN
			CHECKED P. JOHANNESSEN
			APPROVED Y. HO

**ONE INCH AT FULL SCALE. IF NOT, SCALE ACCORDINGLY**  
 FILE NAME: BL1521075P19T03LA-05  
 JOB No.: 554-1521-075 P19 T03  
 DATE: JULY 2017

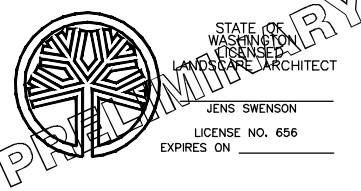

**Parametrix**  
 ENGINEERING · PLANNING · ENVIRONMENTAL SCIENCES  
 719 2ND AVENUE, SUITE 200 | SEATTLE, WA 98104  
 P 206.394.3700  
 WWW.PARAMETRIX.COM

PROJECT NAME  
**EAST LAKE SAMMAMISH MASTER PLAN TRAIL SOUTH SAMMAMISH SEGMENT B**  
 SAMMAMISH, WA